

# RE17RMEMU

time delay relay 8 functions - 1 s..100 h - 24..240 V AC/DC - 1 OC



## Main

Range of product	Zelio Time
Product or component type	Modular timing relay
Discrete output type	Relay
Width	17.5 mm
Device short name	RE17R
Time delay type	H B D At A C Ht Di
Time delay range	6...60 s 6...60 min 1...10 h 0.1...1 s 1...10 s 1...10 min
Nominal output current	8 A

## Complementary

Contacts material	Cadmium free
Control type	Selector switch on front panel
[Us] rated supply voltage	24...240 V AC at 50/60 Hz 24 V DC
Voltage range	0.85...1.1 Us
Supply frequency	50...60 Hz (+/- 5 %)
Input voltage	10 V
Connections - terminals	Screw terminals, clamping capacity: 1 x 0.5...1 x 3.3 mm <sup>2</sup> AWG 20...AWG 12 (solid) without cable end

Screw terminals, clamping capacity: 2 x 0.5...2 x 2.5 mm<sup>2</sup> AWG 20...AWG 14 (solid) without cable end  
 Screw terminals, clamping capacity: 1 x 0.2...1 x 2.5 mm<sup>2</sup> AWG 24...AWG 14 (flexible) with cable end  
 Screw terminals, clamping capacity: 2 x 0.2...2 x 1.5 mm<sup>2</sup> AWG 24...AWG 16 (flexible) with cable end

Tightening torque	0.6...1 N.m conforming to IEC 60947-1
Housing material	Self-extinguishing
Repeat accuracy	+/- 0.5 % conforming to IEC 61812-1
Temperature drift	+/- 0.05 %/°C
Voltage drift	+/- 0.2 %/V
Setting accuracy of time delay	+/- 10 % of full scale at 25 °C conforming to IEC 61812-1
Impulse duration	100 ms with load in parallel typical 30 ms typical
Insulation resistance	100 MOhm at 500 V DC conforming to IEC 60664-1
Reset time	120 ms on de-energisation typical
On-load factor	100 %
Power consumption in VA	<= 32 VA at 240 V AC
Power consumption in W	<= 0.6 W at 24 V DC
Minimum switching current	10 mA 5 V DC
Maximum switching current	5 A AC/DC
Maximum switching voltage	250 V AC
Breaking capacity	<= 2000 VA
Operating rate in Hz	10 Hz
Electrical durability	100000 cycles for resistive load (8 A at 250 V AC maximum)
Mechanical durability	10000000 cycles
Dielectric strength	2.5 kV 1 mA/1 minute 50 Hz conforming to IEC 61812-1
[Uimp] rated impulse withstand voltage	5 kV (1.2/50 µs)
Delay response	< 100 ms
Marking	CE
Creepage distance	4 kV/3 conforming to IEC 60664-1
Safety reliability data	MTTFd = 296.8 years B10d = 270000
Mounting position	Any position in relation to normal vertical mounting plane
Mounting support	35 mm DIN rail conforming to EN/IEC 60715
Local signalling	LED indicator on steady: relay energised, no timing in progress LED indicator flashing: timing in progress (80 % ON and 20 % OFF) LED indicator pulsing: relay de-energised, no timing in progress (except function Di-D, Li-L) (5 % ON and 95 % OFF)
Product weight	0.07 kg

## Environment

Immunity to microbreaks	<= 20 ms
Standards	EN 61000-6-4 2006/95/EC EN 61000-6-1 2004/108/EC EN 61000-6-3 IEC 61812-1 EN 61000-6-2
Product certifications	CULus CSA
Ambient air temperature for storage	-30...60 °C
Ambient air temperature for operation	-20...60 °C
IP degree of protection	IP20 (terminal block) conforming to IEC 60529 IP40 (housing) conforming to IEC 60529 IP50 (front panel) conforming to IEC 60529
Vibration resistance	20 m/s <sup>2</sup> (f = 10...150 Hz) conforming to IEC 60068-2-6
Shock resistance	15 gn (duration = 11 ms) conforming to IEC 60068-2-27
Relative humidity	93 % without condensation conforming to IEC 60068-2-30

Electromagnetic compatibility	<p>Electrostatic discharge immunity test, in contact at 6 kV conforming to IEC 61000-4-2 level 3</p> <p>Electrostatic discharge immunity test, in air at 8 kV conforming to IEC 61000-4-2 level 3</p> <p>Susceptibility to electromagnetic fields, 80 MHz to 1 GHz at 10 V/m conforming to IEC 61000-4-3 level 3</p> <p>Electrical fast transient/burst immunity test, capacitive connecting clip at 1 kV conforming to IEC 61000-4-4 level 3</p> <p>Electrical fast transient/burst immunity test, direct at 2 kV conforming to IEC 61000-4-4 level 3</p> <p>1.2/50 µs shock waves immunity test, differential mode at 1 kV conforming to IEC 61000-4-5 level 3</p> <p>1.2/50 µs shock waves immunity test, common mode at 2 kV conforming to IEC 61000-4-5 level 3</p> <p>Conducted RF disturbances, 0.15...80 MHz at 10 V conforming to IEC 61000-4-6 level 3</p> <p>Voltage dips and interruptions immunity test, 1 cycle at 0 % conforming to IEC 61000-4-11</p> <p>Voltage dips and interruptions immunity test, 25/30 cycles at 70 % conforming to IEC 61000-4-11</p> <p>Conducted and radiated emissions conforming to EN 55022 class B</p>
-------------------------------	---

## Offer Sustainability

Sustainable offer status	Green Premium product
RoHS (date code: YYWW)	<p>Compliant - since 1243 - Schneider Electric declaration of conformity</p> <p> <a href="#">Schneider Electric declaration of conformity</a></p>
REACH	<p>Reference not containing SVHC above the threshold</p> <p><a href="#">Reference not containing SVHC above the threshold</a></p>

---

Function A : Power on Delay Relay

---

Description

The timing period T begins on energisation. After timing, the output(s) R close(s). The second output can be either timed or instantaneous.

Function: 1 Output



Function: 2 Outputs

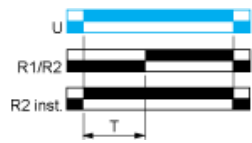

2 timed outputs (R1/R2) or 1 timed output (R1) and 1 instantaneous output (R2 inst.)

---

Function At : Power on Delay Relay (Summation) with Control Signal

---

Description

After power-up, the first opening of control contact C starts the timing. Timing can be interrupted each time control contact closes. When the cumulative total of time periods elapsed reaches the pre-set value T, the output relay closes.

Function: 1 Output

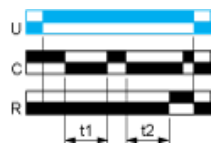

$T = t1 + t2 + \dots$

Function B : Interval Relay with Control Signal

---

Description

After power-up, pulsing or maintaining control contact C starts the timing T. The output R closes for the duration of the timing period T then reverts to its initial state.

Function: 1 Output

---

Function C : Off-Delay Relay with Control Signal

---

Description

After power-up and closing of the control contact C, the output R closes. When control contact C re-opens, timing T starts. At the end of the timing period, the output(s) R revert(s) to its/their initial state. The second output can be either timed or instantaneous.

Function: 1 Output

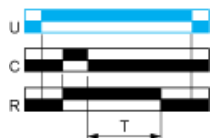

Function: 2 Outputs

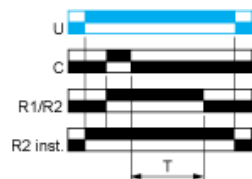

2 timed outputs (R1/R2) or 1 timed output (R1) and 1 instantaneous output (R2 inst.)

---

Function D : Symmetrical Flasher Relay (Starting Pulse Off)

---

Description

Repetitive cycle with two timing periods T of equal duration, with output(s) R changing state at the end of each timing period T.  
The second output can be either timed or instantaneous.

Function: 1 Output

Function: 2 Outputs

2 timed outputs (R1/R2) or 1 timed output (R1) and 1 instantaneous output (R2 inst.)



---

## Function Di : Symmetrical Flasher Relay (Starting Pulse On)

---

### Description

Repetitive cycle with two timing periods  $T$  of equal duration, with output(s)  $R$  changing state at the end of each timing period  $T$ .  
The second output can be either timed or instantaneous.

### Function: 1 Output



### Function: 2 Outputs



2 timed outputs (R1/R2) or 1 timed output (R1) and 1 instantaneous output (R2 inst.)

---

Function H : Interval Relay

---

Description

On energisation of the relay, timing period T starts and the output(s) R close(s). At the end of the timing period T, the output(s) R revert(s) to its/ their initial state. The second output can be either timed or instantaneous.

Function: 1 Output



Function: 2 Outputs

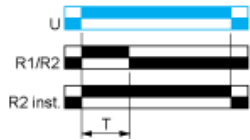

2 timed outputs (R1/R2) or 1 timed output (R1) and 1 instantaneous output (R2 inst.)

---

Function Ht : Interval Relay (Summation) with Control Signal

---

Description

On energisation, the output R closes for the duration of a timing period T then reverts to its initial state.

Pulsing or maintaining control contact C will again close the output R.

Timing T is only active when control contact C is released and so the output R will not revert to its initial state until after a time  $t_1 + t_2 + \dots$

The relay memorises the total, cumulative opening time of control contact C and, once the set time T is reached, the output R reverts to its initial state.

Function: 1 Output

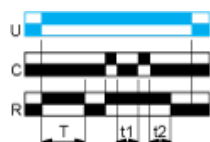

$$T = t_1 + t_2 + \dots$$

---

Legend

---

Relay de-energised

Relay energised

Output open

Output closed

C Control contact

G Gate

R Relay or solid state output

R1/R2 2 timed outputs

R2 inst. The second output is instantaneous if the right position is selected

T Timing period

Ta Adjustable On-delay

Tr Adjustable Off-delay

U Supply

---

Width 17.5 mm

---

Internal Wiring Diagram

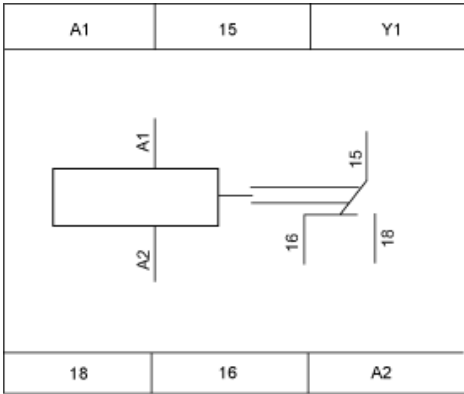

## Wiring Diagram

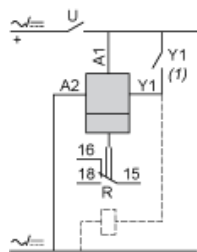

### 1) Contact Y1:

- Control for functions B, C, Ac, Bw, Ad, Ah, N, O, W, T, Tt.
- Partial stop for functions At, Ht and Pt.
- Function D if Di selected.
- Not used for functions A, H and P.