

## General Description

The MAX30110 evaluation kit (EV kit) allows for the quick evaluation of the MAX30110 and MAX30112 optical AFE for applications at various sites on the body, particularly the wrist. MAX30110 supports standard SPI compatible interface, whereas MAX30112 supports I<sup>2</sup>C compatible interface. The EV kit allows flexible configurations to optimize measurement signal quality at minimal power consumption. The EV kit helps the user quickly learn how to configure and use the MAX30110 and MAX30112.

The EV kit consists of three boards. MAX30110\_UC\_EVKIT is the main data acquisition board while MAX30110\_SF7050\_EVKIT and MAX30110\_OSB\_EVKIT are the sensor daughter boards in which the MAX30110 devices are placed in different optical configurations. The EV kit is powered using the USB supply to generate +1.8V for the AFE and accelerometer and +4.5V for the LEDs.

The EV kit comes with a MAX30110EWG+ in a 24-bump wafer-level package (WLP).

## Features

- Quick Evaluation of the MAX30110
- Supports Optimization of Configurations
- Facilitates Understanding MAX30110 Architecture and Solution Strategy
- Real-Time Monitoring
- Data-Logging Capabilities
- USB-Powered
- On-Board Accelerometer

**Ordering Information** appears at end of data sheet.

## Quick Start

### Required Equipment

- MAX30110 EV Kit
  - MAX30110 EV Kit Micro-PCB (MAX30110\_UC\_EVKIT)
  - MAX30110 EV Kit Sensor PCB 1 (MAX30110\_OSB\_EVKIT)
  - MAX30110 EV Kit Sensor PCB 2 (MAX30110\_SF7050\_EVKIT)
  - 10-pin Flex cable
  - Micro-USB cable
  - MAX30110 EV Kit GUI Software
- Windows PC

### Procedure

- 1) The EV kit is fully assembled and tested. Follow the steps below to verify board operation: Visit [www.maximintegrated.com/evkit-software](http://www.maximintegrated.com/evkit-software) to download the most recent version of the EV kit software, MAX30110GUISetupVxxx\_Web.ZIP. Save the EV kit software to a temporary folder and uncompress the ZIP file.
- 2) Open up MAX30110GUISetupVxxx.exe and follow the instructions from the pop-up windows as shown in [Figure 1](#), [Figure 2](#), [Figure 3](#), and [Figure 4](#).
- 3) If the MAX30110 EV kit 10-pin flex cable is not already connecting the MAX30110 EV kit micro-PCB to the MAX30110 EV kit sensor PCB 1/2, then connect the two PCBs with the cable as shown in [Figure 5](#), [Figure 6](#), [Figure 7](#), [Figure 8](#), and [Figure 9](#).
- 4) Use the micro-USB cable to connect the MAX30110 EV Kit micro-PCB to any USB adapter in a Window 7, or Window 10 compatible PC.
- 5) After that, start the MAX30110 EV kit GUI program. The GUI will be launched as shown in [Figure 10](#).
- 6) Look for the “Connected” statement in the lower right hand of the GUI as shown in [Figure 10](#). If “Disconnected” is shown in the Connection Status, please check the USB connection.
- 7) Click on the <Start Monitor> button on the left side to start the data acquisition.
- 8) When running, the LEDs on the micro-PCB should illuminate and the five graphs on the GUI should stream with data.

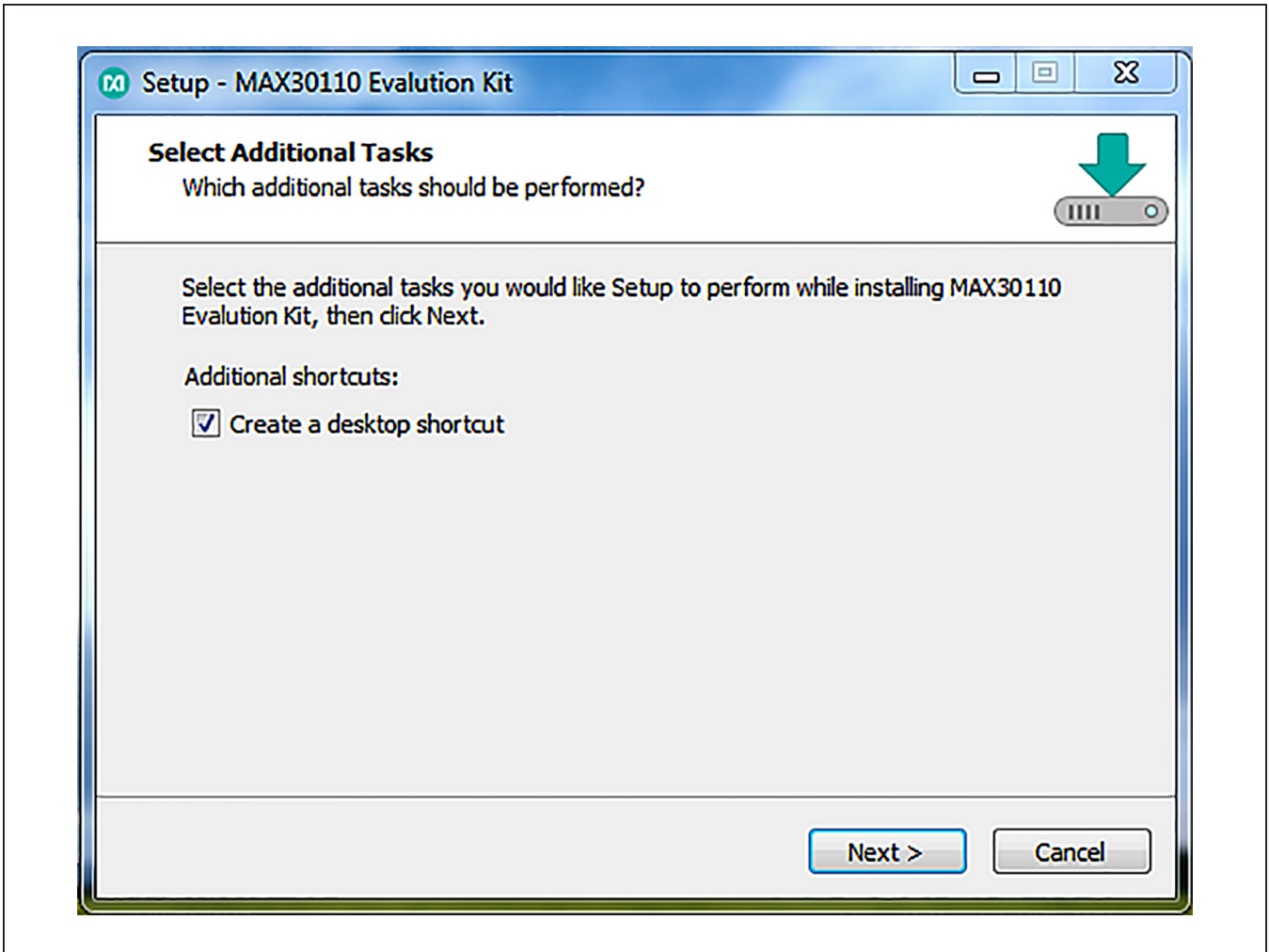

Figure 1. MAX30110 EV Kit—Setup GUI Software Step 1

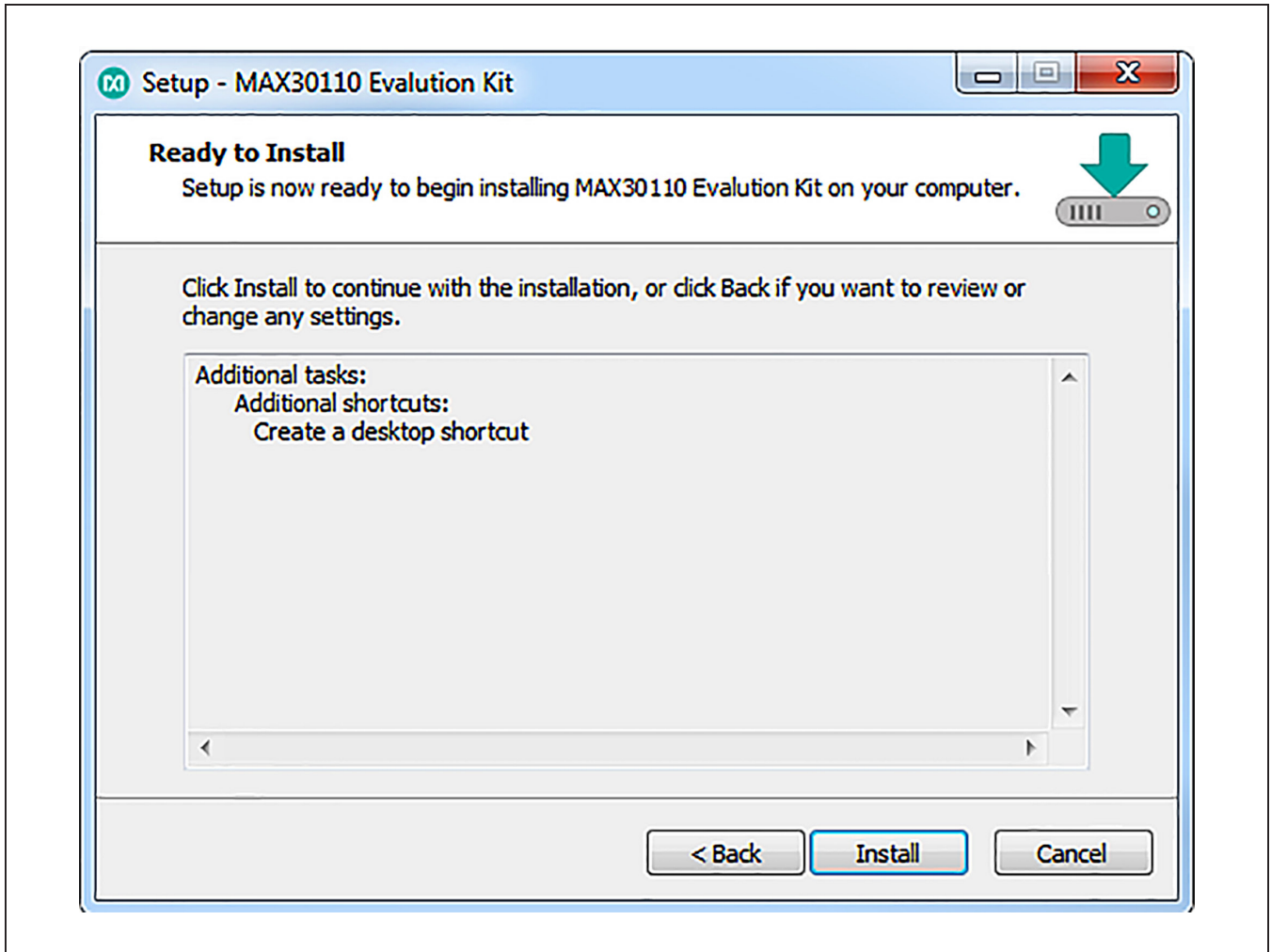

Figure 2. MAX30110 EV Kit—Setup GUI Software Step 2

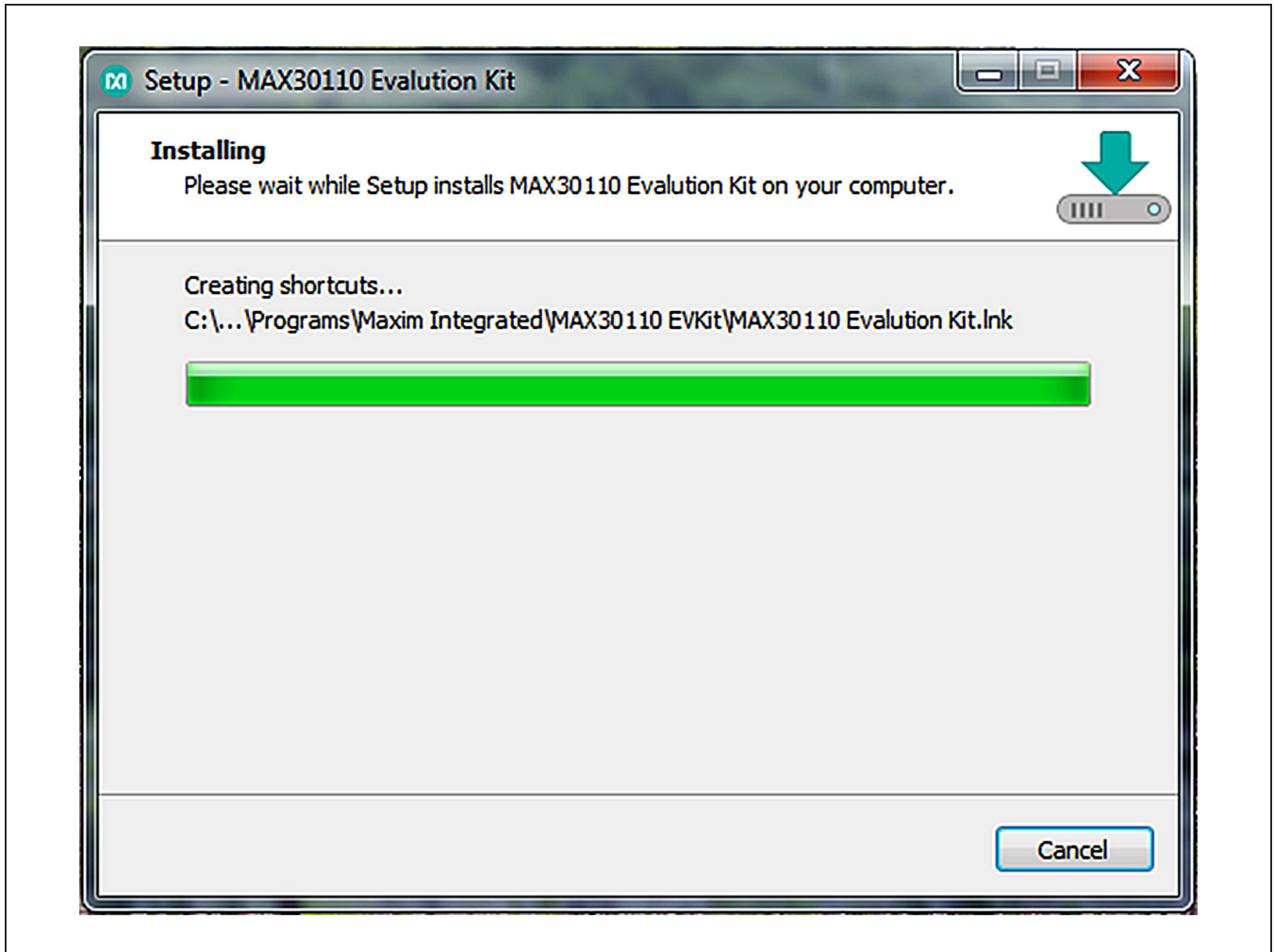

Figure 3. MAX30110 EV Kit—Setup GUI Software Step 3

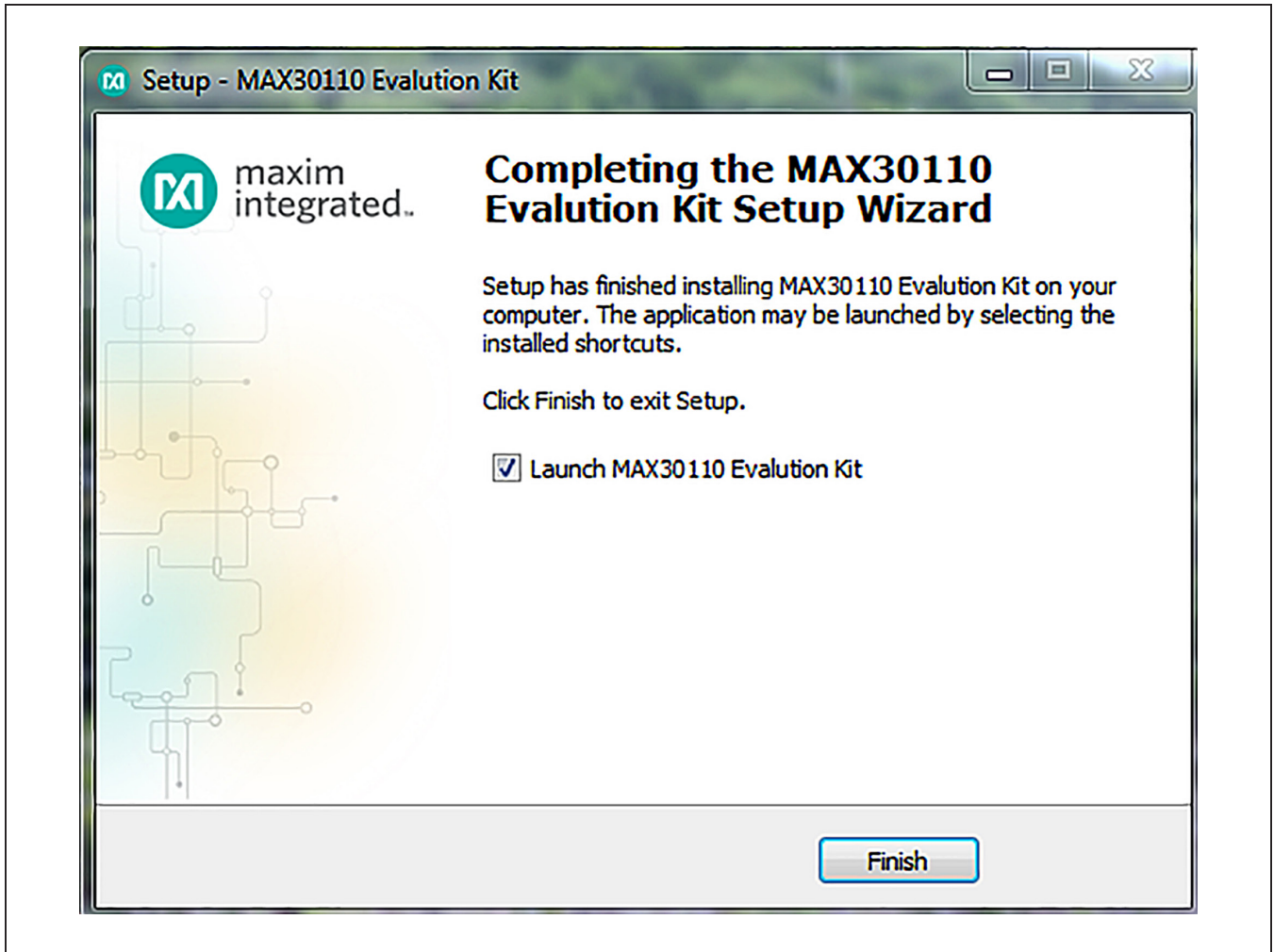

Figure 4. MAX30110 EV Kit—Setup EVKIT GUI Software Step 4

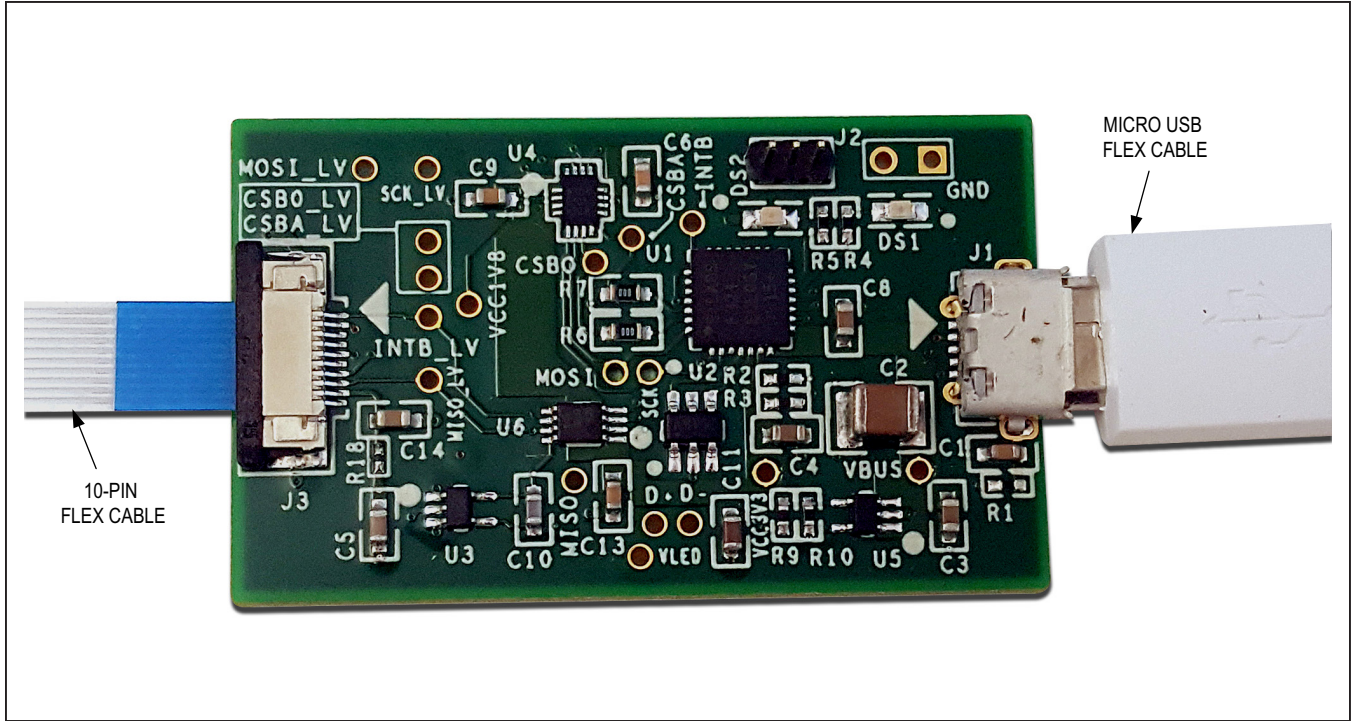

Figure 5. MAX30110 EV Kit—Hardware Setup (Micro-PCB)

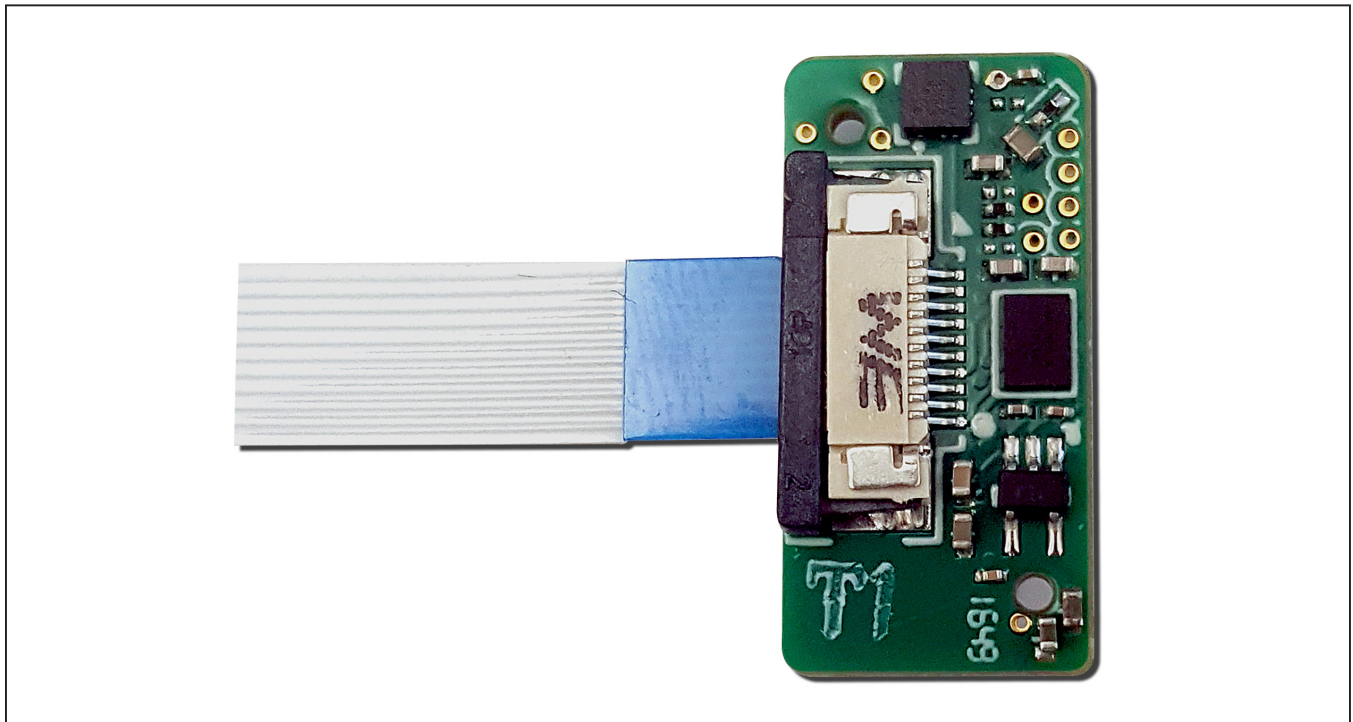

Figure 6. MAX30110 EV Kit—Hardware Setup (Sensor PCB 1)

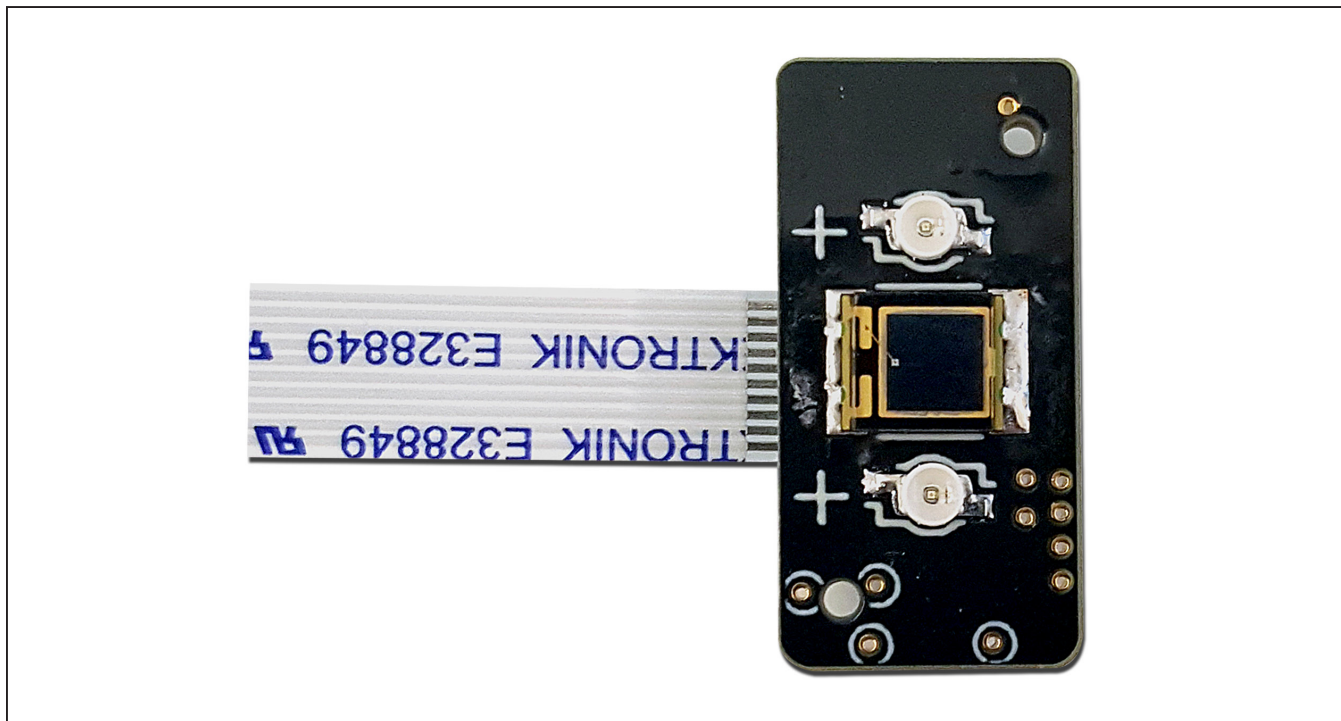

Figure 7. MAX30110 EV Kit—Hardware Setup (Sensor PCB 1 – Top View)

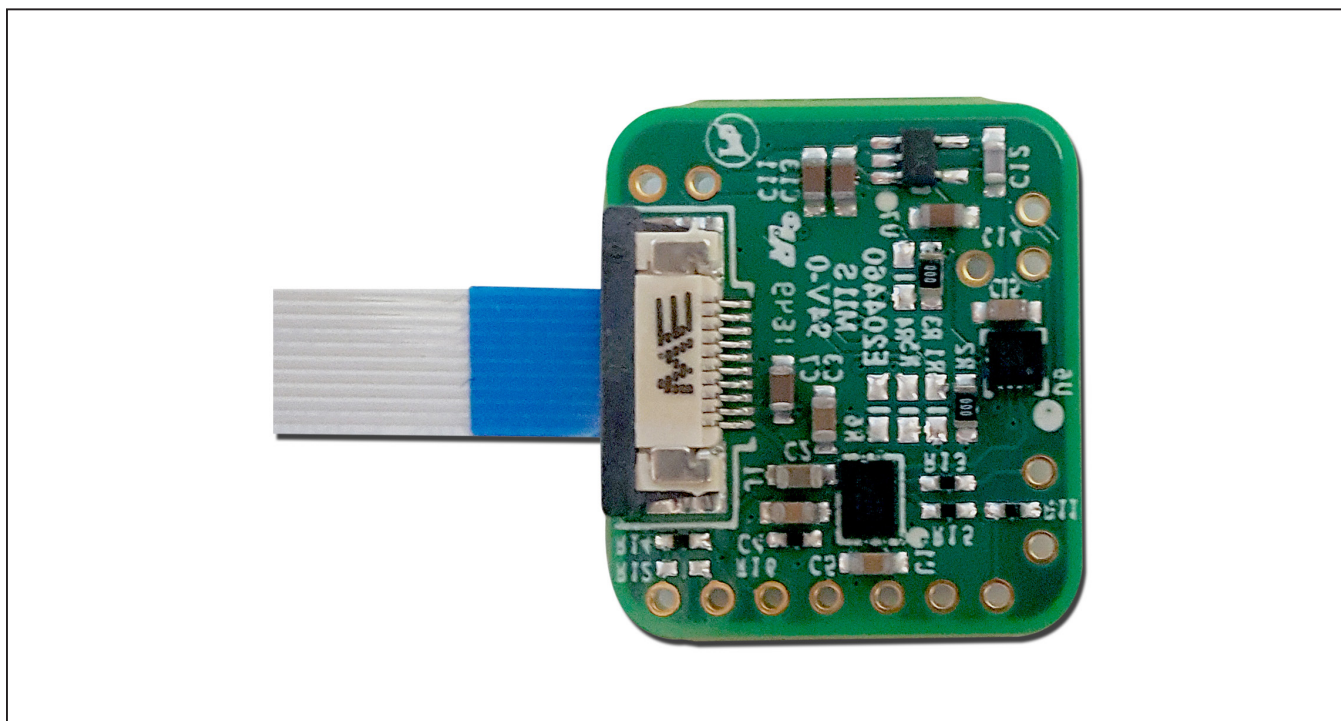

Figure 8. MAX30110 EV Kit—Hardware Setup (Sensor PCB 2 – Bottom View)

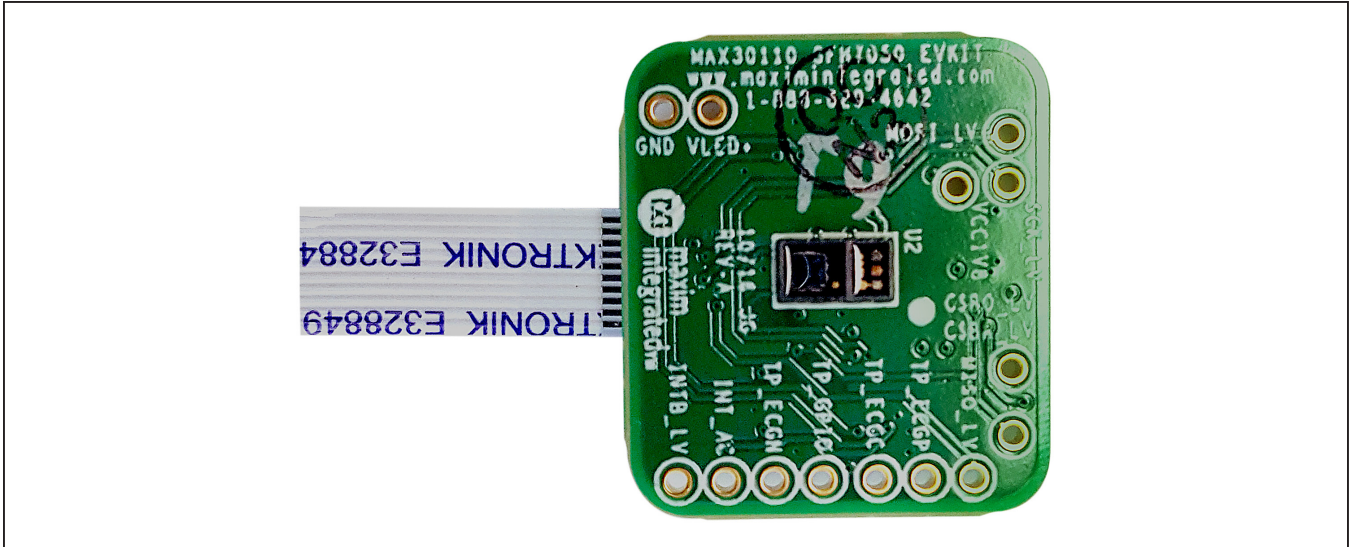

Figure 9. MAX30110 EV Kit—Hardware Setup (Sensor PCB 2 – Top View)

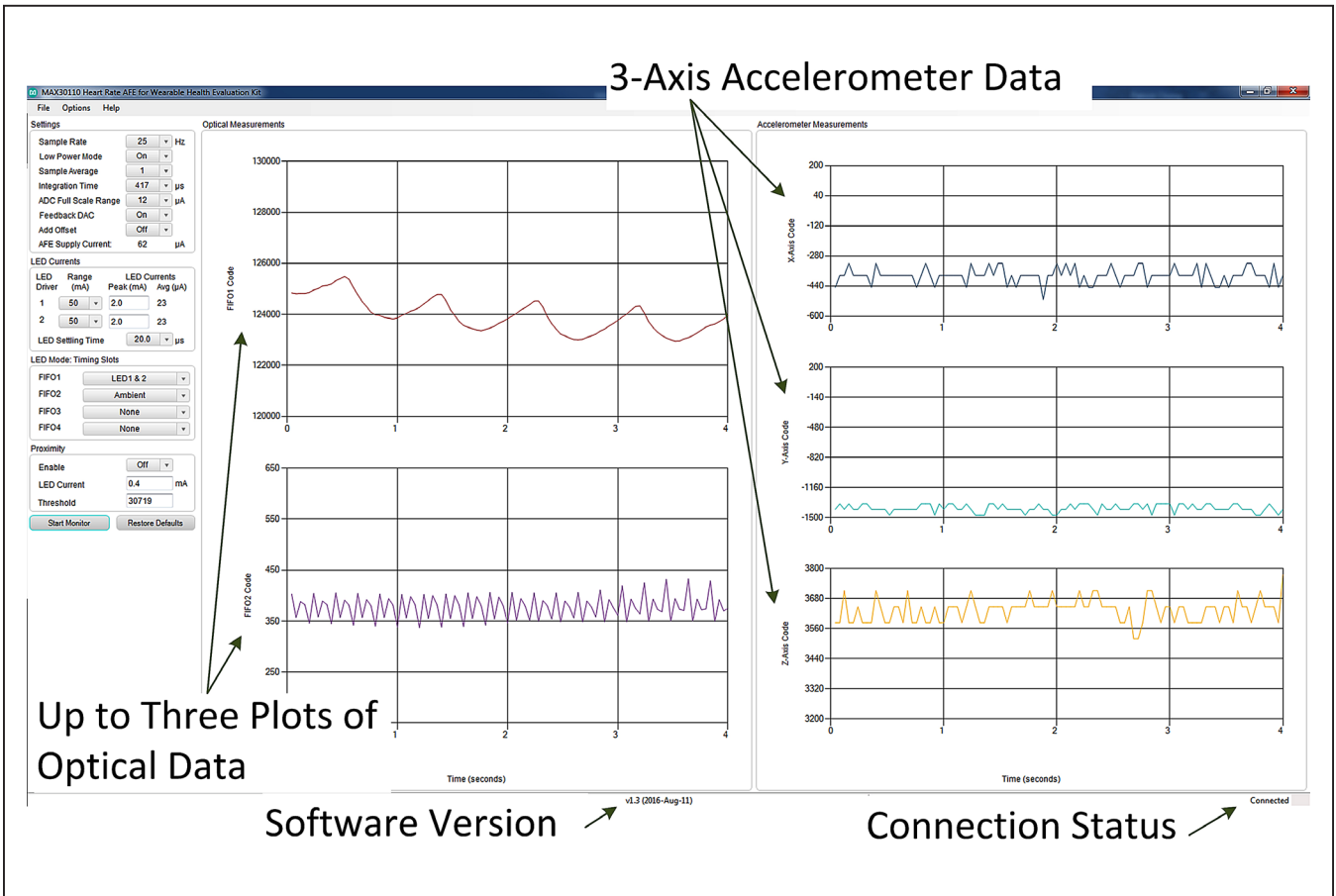

Figure 10. MAX30110 EV Kit—GUI



## Detailed Description of Software

The MAX30110 EV kit includes two sensor PCBs. Each contains a MAX30110 optical AFE, a 3-axis accelerometer together with two different photodiodes and LEDs combination. MAX30110\_OSB\_EVKIT comes with a discreet photodiode (TEMD5010X01) and two green LEDs (LT P4SG-V1AB-36-F), while MAX30110\_SF7050\_EVKIT comes with OSRAM SFH7050 integrated module. SFH7050 consists of an integrated photodiode and three LEDs (Red/Green/Infrared). The EV kit allows raw optical and accelerometer data to be sampled and transferred to the GUI for both dynamic viewing and logging for later analysis. The MAX30110 EV kit microcontroller PCB is used to do SPI to HID transaction translation, transporting the raw optical and accelerometer data to the PC through the USB.

Most functionality of the MAX30110 has been mapped to the GUI so the wide variety of applications supported by the MAX30110 can be rapidly explored. The following is a brief description of this functionality's options.

Note that the accelerometer is operated in the 8G gain mode and its sampling rate is set to nominally match the selected sample rate of the MAX30110 with the exception of the 84sps. The two devices control sample rates internally and are inherently asynchronous. Thus the log file generated includes a sample time column that is unique for each device.

### Sample Rate

The sample rate can take on values between 25 to 400sps. The values marked with a (2) are dual pulse modes. These are modes where the samples are unevenly spaced and averaged to improve the ambient rejection of mains line rate ambient signals. The MAX30110 can support rates up to 3.2ksps but the HID interface for the MAX30110 EV-kit has insufficient bandwidth to support rates above 400sps. Thus, these higher rates are unavailable in the MAX30110 EV kit.

### Low Power Mode

Low power is an auto-shutdown mode that significantly reduces the average power of the AFE. This is available for all sample rates at or below 100sps. If sample rates above 100sps is selected the MAX30110 will run in regular power mode.

### Sample Average

The MAX30110 has the capability to do sample averaging of 2, 4, 8, 16, and 32 samples internally. This feature is useful if more optical energy is needed to make a low

perfusion measurement but the data rate across the interface or the processing power in a host micro is not desirable. This mode is also useful to further suppress the mains line noises in indoor lighting conditions.

### Pulse Width

The pulse width setting adjusts the integration time of an exposure. The MAX30110 supports exposure integration times of 52 $\mu$ s, 104 $\mu$ s, 208 $\mu$ s, and 417 $\mu$ s. The integrated pulse width is a critical parameter in any optical measurement. Longer exposures allow for more optical photons to be integrated but also increase system power and reduce ambient rejection capability.

Longer exposures also reduce the MAX30110 effective noise bandwidth and reduce the quantization step size. With a 417 $\mu$ s integration time, the MAX30110 quantization level equals the full-scale range/ $2^{19}$ . This quantization level reduces by a factor of two with each factor of two reduction in pulse width such that the quantization level with a 50 $\mu$ s integration time is full-scale range/ $2^{16}$ .

The logged data and displayed graph continue to show a 19-bit signal range regardless of integration time. However, the LSBs at shorter pulse widths are fixed at zero. Thus with a pulse integration time of 417 $\mu$ s, all 19-bits are active. At 208 $\mu$ s pulse width, the upper 18-bits are active and the LSB is fixed at zero. At 104 $\mu$ s pulse width, the upper 17-bits are active and the two lower bits (B1 and B0) are fixed at zero. Finally at 52 $\mu$ s pulse width, the upper 16-bits are active and the lower three bits (B2, B1, and B0) are fixed at zero.

### ADC Full-Scale Range

The MAX30110 optical channel has 4 gain ranges. When the feedback DAC (see below) is enabled, these ranges are 6 $\mu$ A, 12 $\mu$ A, 24 $\mu$ A, 48 $\mu$ A. When the feedback DAC is disabled, these ranges drop by a factor of 8 (3-bits) to 0.75 $\mu$ A, 1.5, 3 $\mu$ A, and 6 $\mu$ A.

### Feedback DAC

The feedback DAC is a dynamic range extension to the native 16-bit  $\Delta\Sigma$  ADC. When enabled, the optical ADC channel is extended to 19-bits. When disabled the optical ADC channel has 16-bits of resolutions. This feature was added because virtually all the DNL in the converter comes from the feedback DAC. Thus, by disabling this DAC, one can significantly improve the DNL of the ADC with a compromise in overall dynamic range. Note that when disabling the feedback DAC, the full-scale gain ranges all divide by a factor of 8x.

### Add Offset

Add Offset is a test option designed for dark current measurement. By adding offset to the PPG Data would allow dark current measurement without clipping the signal below 0. When Add Offset is On, an offset is added to the PPG Data to be able to measure the dark current. The offset is 8192 counts if Sample Rate is programmed for single-pulse mode. The offset is 4096 counts if PPG\_SR is programmed for dual-pulse mode.

### AFE Supply Current

Average AFE supply current is computed from the AFE settings and displayed. This is not a measured current but is computed from measured models.

### LED Driver Settings

Each of the two LED drivers has a Range and Peak LED Current setting. There are 4 full-scale range settings 50mA, 100mA, 150mA and 200mA. Each range has an 8-bit current source DAC. The Peak LED Current box allows for an actual current to be entered. The nearest available DAC current is selected and displayed in the field.

### Avg LED Current

The Avg LED Current field displays the average LED current based on the current AFE and LED settlings. This is a computed value based on measure characterization data. This value assumes the LED current source is fully saturated.

### LED Settling Time

The LED Settling Time is the time prior to the start of integration (pulse-width setting) that the LED is turned on. There are four settlings, 20 $\mu$ s (default), 10 $\mu$ s, 5 $\mu$ s, and 2.5 $\mu$ s. This time is necessary to allow the LED driver to settle before integrating the exposure photo current. In practice 5 $\mu$ s proves to be sufficient LED settling time for low-noise applications.

### LED Mode Timing Slots

The LED Mode Timing Slots specifies the data acquisition sequence that the internal state machine controller will follow and where the converted data will be mapped into the FIFO. Each FIFO field can be applied to one measurement. Acquired data can be LED1 (optical exposure from LED1 illumination), LED2 (optical exposure from LED2

illumination), LED1 and LED2 (optical exposure from LED1 and LED2 fired simultaneous), Ambient (optical data with no exposure, just ambient illumination) or None (skip this acquisition). The exposer sequence will be the entry in FIFO1 slot, FIFO2 slot, FIFO3 slot, then FIFO4 slot. This sequence will repeat for each sample instance. The data from FIFO4 Slot will not be plotted in the GUI, but will be saved to the log file.

### <Start Monitor>/<Stop Monitor> Button

The <Start Monitor> button is used to start data acquisition from the demo. The <Start Monitor> button will only be highlighted when the MAX301100 EV-kit USB is connected and detected. Once the <Start Monitor> has been pushed the <Stop Monitor> button appears, which can be used to stop the acquisition. Once the acquisition has started, all settling are locked. Terminate the acquisition to change any settling.

### <Restore Defaults> Button

The <Restore Defaults> button will clear out all register settlings back to the programs start up.

### Data Logging

Raw optical and accelerometer data can be logged from the <File> pull-down menu item. When data logging is selected, the GUI asks for a filename with a default time-stamped entered into the familiar <filename> field. Enter a new filename or accept the default. Data logging will start on the next <Start Monitor> button and will continue until the <Stop Monitor> button is pressed. The final file write is only done when the <File> pull-down menu item is accessed and the data-logging button is pressed.

### Direct Register Write

Under the <Options> pull-down menu is a direct register write button. This button opens two fields, an address and data field, below the LED Mode Timing Slots box. Any register address byte and data byte can be entered in these fields. Caution should be exercised when using this feature. Some of these registers will result in undocumented behavior. There is no risk of damaging the part. However, it is possible to lock up the part, requiring a power cycle induced, power on reset (unplug the USB and plug it back in again) to exit a locked-up condition.

MAX30110 EV Kit Bill of Materials

MAX30110\_UC\_EVKIT

ITEM	QTY	REF DES	MFG PART #	MANUFACTURER	VALUE	DESCRIPTION
1	5	C1, C6, C7, C9, C13	C0603C104K4RACAUTO	KEMET	0.1UF	CAPACITOR; SMT (0603); CERAMIC CHIP; 0.1UF; 16V; TOL = 10%; TG = -55°C TO +125°C; TC = X7R AUTO
2	1	C2	GRM32ER71H106KA12L; CL32B106KBJNNN	MURATA; SAMSUNG ELECTRONICS	10UF	CAPACITOR; SMT (1210); CERAMIC CHIP; 10UF; 50V; TOL = 10%; TG = -55°C TO +125°C; TC = X7R
3	4	C3, C4, C8, C14	UMK107AB7105KA	TAIYO YUDEN	1UF	CAPACITOR; SMT (0603); CERAMIC CHIP; 1UF; 50V; TOL = 10%; TG = -55°C TO +125°C; TC = X7R
4	2	C5, C12	C1608X5R1E475K080AC; GRM188R61E475KE11	TDK; MURATA	4.7UF	CAPACITOR; SMT (0603); CERAMIC CHIP; 4.7UF; 25V; TOL = 10%; TG = -55°C TO +85°C; TC = X5R
5	1	C10	C1608C0G1H103J; CGA3E2C0G1H103J080AD; GRM1885C1H103JA01	TDK; MURATA	0.01UF	CAPACITOR; SMT (0603); CERAMIC CHIP; 0.01UF; 50V; TOL = 5%; TG = -55°C TO +125°C; TC = C0G
6	1	C11	C1608X5R1E106M080AC; CL10A106MA8NRNC	TDK/SAMSUNG ELECTRONICS	10UF	CAPACITOR; SMT (0603); CERAMIC CHIP; 10UF; 25V; TOL = 20%; TG = -55°C TO +85°C; TC = X5R
7	1	DS1	HSMH-C190	AVAGO TECHNOLOGIES	HSMH-C190	DIODE; LED; SURFACE MOUNT CHIP LED; RED; SMT (0603); PIV = 1.8V; IF = 0.02A
8	1	DS2	HSMG-C190	AVAGO TECHNOLOGIES	HSMG-C190	DIODE; LED; SURFACE MOUNT CHIP LED; GREEN; SMT (0603); PIV = 2.2V; IF = 0.02A
9	1	J1	ZX62RD-AB-5P8	HIROSE ELECTRIC CO LTD.	ZX62RD-AB-5P8	CONNECTOR; MALE; SMT; MICRO-USB CONNECTOR MEETING REQUIREMENTS OF USB 2.0 STANDARD; RIGHT ANGLE; 5PINS
10	1	J2	GRP031VWVN-RC	SULLINS ELECTRONICS CORP.	GRP031VWVN-RC	CONNECTOR; MALE; THROUGH HOLE; 0.050 SINGLE ROW MALE HEADER CONNECTOR; STRAIGHT; 3PINS; -40°C TO +105°C
11	1	J3	68711014522	WURTH ELECTRONICS INC.	68711014522	CONNECTOR; FEMALE; SMT; 0.5MM ZIF HORIZONTAL BOTTOM CONTACT WR-FPC; RIGHT ANGLE; 10PINS
12	3	R1, R4, R5	ERJ-2GEJ471X	PANASONIC	470	RESISTOR; 0402; 470Ω; 5%; 200PPM; 0.10W; THICK FILM
13	2	R2, R3	ERJ-2GEJ472X	PANASONIC	4.7K	RESISTOR; 0402; 4.7KΩ; 5%; 200PPM; 0.10W; THICK FILM
14	2	R6, R7	CRCW06030000ZS; MCR03EZPJ000; ERJ-3GEY0R00	VISHAY DALE/ROHM/PANASONIC	0	RESISTOR; 0603; 0Ω; 0%; JUMPER; 0.10W; THICK FILM
15	2	R8, R11	N/A	N/A	OPEN	PACKAGE OUTLINE 0603 RESISTOR - EVKIT
16	1	R9	CRCW040213K7FK	VISHAY DALE	13.7K	RESISTOR; 0402; 13.7KΩ; 1%; 100PPM; 0.063W; THICK FILM
17	1	R10	CRCW040236K5FK	PANASONIC	36.5K	RESISTOR; 0402; 36.5KΩ; 1%; 100PPM; 0.063W; THICK FILM
18	2	R12, R13	CRCW06034K70FK	VISHAY DALE	4.7K	RESISTOR; 0603; 4.7KΩ; 1%; 100PPM; 0.10W; THICK FILM
19	4	R14-R17	CRCW0603100RFK; ERJ-3EKF1000	VISHAY DALE/PANASONIC	100	RESISTOR; 0603; 100Ω; 1%; 100PPM; 0.10W; THICK FILM
20	1	R18	RC0201FR-078R2	YAGEO PHYCOMP	8.2	RESISTOR; 0201; 8.2Ω; 1%; 100PPM; 0.05W; THICK FILM 3-LAYER ELECTRODE
21	1	U1	C8051F321	SILICON LABORATORIES	C8051F321	IC; CTRL; FULL SPEED USB, 16K ISP FLASH MCU FAMILY; QFN28-EP
22	1	U2	MAX3207EAUT+	MAXIM	MAX3207EAUT	IC; PROT; DUAL, QUAD, AND HEX HIGH-SPEED DIFFERENTIAL ESD-PROTECTION IC; SOT23-6
23	1	U3	MAX8510EXK18	MAXIM	MAX8510EXK18	IC; VREG; ULTRA-LOW-NOISE; HIGH PSRR; LOW-DROPOUT; 0.12A LINEAR REGULATOR; SC70-5
24	1	U4	74AVC4TD245GU	NXP	74AVC4TD245GU	IC; TXRX; 4-BIT DUAL SUPPLY TRANSLATING TRANSCEIVER WITH CONFIGURABLE VOLTAGE TRANSLATION; 3-STATE; XQFN16
25	1	U5	MAX8512EXK	MAXIM	MAX8512EXK	IC; VREG, Ultra-Low-Noise, High PSRR, Adjustable V <sub>OUT</sub> ; SC70-5
26	1	U6	74AVCH2T45DC	PHILIPS SEMICONDUCTORS/NXP	74AVCH2T45DC	IC; TXRX; DUAL-BIT, DUAL-SUPPLY VOLTAGE LEVEL TRANSLATOR/TRANSCEIVER; 3-STATE; VSSOP8
27	1		MAX	MAXIM	PCB	PCB: MAX

## MAX30110 EV Kit Bill of Materials (continued)

## MAX30110\_OS\_B\_EVKIT

ITEM	QTY	REF DES	MFG PART #	MANUFACTURER	VALUE	DESCRIPTION
1	4	C2, C3, C8, C9	C0402X5R100-105KNE; GRM155R61A105KE15	VENKEL LTD./MURATA	1UF	CAPACITOR; SMT (0402); CERAMIC CHIP; 1UF; 10V; TOL = 10%; MODEL=; TG = -55°C TO +85°C; TC = X5R
2	3	C4, C5, C15	C0603X5R1C104K030BC	TDK	0.1UF	CAPACITOR; SMT (0201); CERAMIC CHIP; 0.1UF; 16V; TOL = 10%; TG = -55°C TO +85°C; TC = X5R
3	1	C7	CL05A106MP5NUNC	SAMSUNG ELECTRONICS	10UF	CAPACITOR; SMT (0402); CERAMIC CHIP; 10UF; 10V; TG = -55°C TO +85°C; TC = X5R
4	3	C11, C13, C14	C1005X5R1A475K050	TDK	4.7UF	CAPACITOR; SMT (0402); CERAMIC CHIP; 4.7UF; 10V; TOL = 10%; TG = -55°C TO +85°C; TC = X5R
5	1	C12	GRM033R61C103KA12	MURATA	0.01UF	CAPACITOR; SMT (0201); CERAMIC CHIP; 0.01UF; 16V; TOL = 10%; TG = -55°C TO +85°C; TC = X5R
6	1	D1	TEMD5010X01	VISHAY SEMICONDUCTORS	TEMD5010X01	DIODE; PIN; SILICON PIN PHOTODIODE; SMT; PIV = 60V; IF = 0.000055A
7	2	DS7, DS8	LT P4SG-V1AB-36-F	OSRAM	LT P4SG-V1AB-36-F	DIODE; LED; POINTLED; GREEN; SMT; VF = 3.2V; IF = 0.02A
8	1	J1	68711014522	WURTH ELECTRONICS INC.	68711014522	CONNECTOR; FEMALE; SMT; 0.5MM ZIF HORIZONTAL BOTTOM CONTACT WR-FPC; RIGHT ANGLE; 10PINS
9	3	R1, R2, R5	CRCW02010000ZS; ERJ-1GN0R00C	VISHAY DALE/ PANASONIC	0	RESISTOR; 0201; 0Ω; 0%; JUMPER; 0.05W; THICK FILM
10	1	U1	MAX30110EWG+T	MAXIM	MAX30110EWG+T	EVKIT PART-IC; COMPLETE OPTICAL ANALOG FRONT-END WITH DATA CONVERTER; LED DRIVER AND CONTROL; MAX30110; 0.4MM PITCH; PACKAGE OUTLINE: 21-100088; WLP24
11	1	U6	LIS2DH	ST MICROELECTRONICS	LIS2DH	IC; MEMS; MEMS DIGITAL OUTPUT MOTION SENSOR; ULTRA LOW-POWER HIGH PERFORMANCE 3-AXIS FEMTO ACCELEROMETER; LGA14 2X2
12	1	U7	MAX8510EXK18	MAXIM	MAX8510EXK18	IC; VREG; ULTRA-LOW-NOISE; HIGH PSRR; LOW-DROPOUT; 0.12A LINEAR REGULATOR; SC70-5
13	1	PCB	MAX	MAXIM	PCB	PCB:MAX

## MAX30110 EV Kit Bill of Materials (continued)

## MAX30110\_SF7050\_EVKIT

ITEM	QTY	REF DES	MFG PART #	MANUFACTURER	VALUE	DESCRIPTION
1	2	C2, C3	UMK107AB7105KA	TAIYO YUDEN	1UF	CAPACITOR; SMT (0603); CERAMIC CHIP; 1UF; 50V; TOL = 10%; TG = -55°C TO +125°C; TC = X7R
2	3	C4, C5, C15	C0603C104K4RACAU0	KEMET	0.1UF	CAPACITOR; SMT (0603); CERAMIC CHIP; 0.1UF; 16V; TOL = 10%; TG = -55°C TO +125°C; TC = X7R AUTO
3	1	C7	C1608X5R1E106M080AC; CL10A106MA8NRNC	TDK/SAMSUNG ELECTRONICS	10UF	CAPACITOR; SMT (0603); CERAMIC CHIP; 10UF; 25V; TOL = 20%; TG = -55°C TO +85°C; TC = X5R
4	3	C11, C13, C14	C1608X5R1E475K080AC; GRM188R61E475KE11	TDK; MURATA	4.7UF	CAPACITOR; SMT (0603); CERAMIC CHIP; 4.7UF; 25V; TOL = 10%; TG = -55°C TO +85°C; TC = X5R
5	1	C12	C1608C0G1H103J; CGA3E2C0G1H103J080AD; GRM1885C1H103JA01	TDK; MURATA	0.01UF	CAPACITOR; SMT (0603); CERAMIC CHIP; 0.01UF; 50V; TOL = 5%; TG = -55°C TO +125°C; TC = COG
6	1	J1	68711014522	WURTH ELECTRONICS INC.	68711014522	CONNECTOR; FEMALE; SMT; 0.5MM ZIF HORIZONTAL BOTTOM CONTACT WR-FPC; RIGHT ANGLE; 10PINS
7	2	R2, R3	RC1608J000CS; CR0603-J-000ELF; RC0603JR-070RL	SAMSUNG ELECTRONICS/ BOURNS/YAGEO PH	0	RESISTOR; 0603; 0Ω; 5%; JUMPER; 0.10W; THICK FILM
8	3	R11, R14, R15	CRCW0402100RFK; 9C04021A1000FL; RC0402FR-07100RL	VISHAY DALE; PANASONIC; YAGEO PHYCOMP	100	RESISTOR; 0402; 100Ω; 1%; 100PPM; 0.063W; THICK FILM
9	2	R13, R16	CRCW04020000Z0EDHP	VISHAY DRALORIC	0	RESISTOR; 0402; 0Ω; 0%; JUMPER; 0.2W; THICK FILM
10	1	U1	MAX30111	MAXIM	MAX30111	EVKIT PART-IC; MAX30111; OPEN FRAME DIP ECONOMY; 0.4MM PITCH; PACKAGE OUTLINE: 21-100088; WLP24
11	1	U2	Q65111A6271	OSRAM	Q65111A6271	IC; SNSR; BIOMON SENSOR; MULTICHIP PACKAGE FEATURING THREE EMITTERS AND ONE DETECTOR; SMT
12	1	U6	LIS2DH	ST MICROELECTRONICS	LIS2DH	IC; MEMS; MEMS DIGITAL OUTPUT MOTION SENSOR; ULTRA LOW-POWER HIGH PERFORMANCE 3-AXIS FEMTO ACCELEROMETER; LGA14 2X2
13	1	U7	MAX8510EXK18	MAXIM	MAX8510EXK18	IC; VREG; ULTRA-LOW-NOISE; HIGH PSRR; LOW-DROPOUT; 0.12A LINEAR REGULATOR; SC70-5
14	1		MAX	MAXIM	PCB	PCB: MAX





MAX30110\_SF7050\_EVKIT Schematic

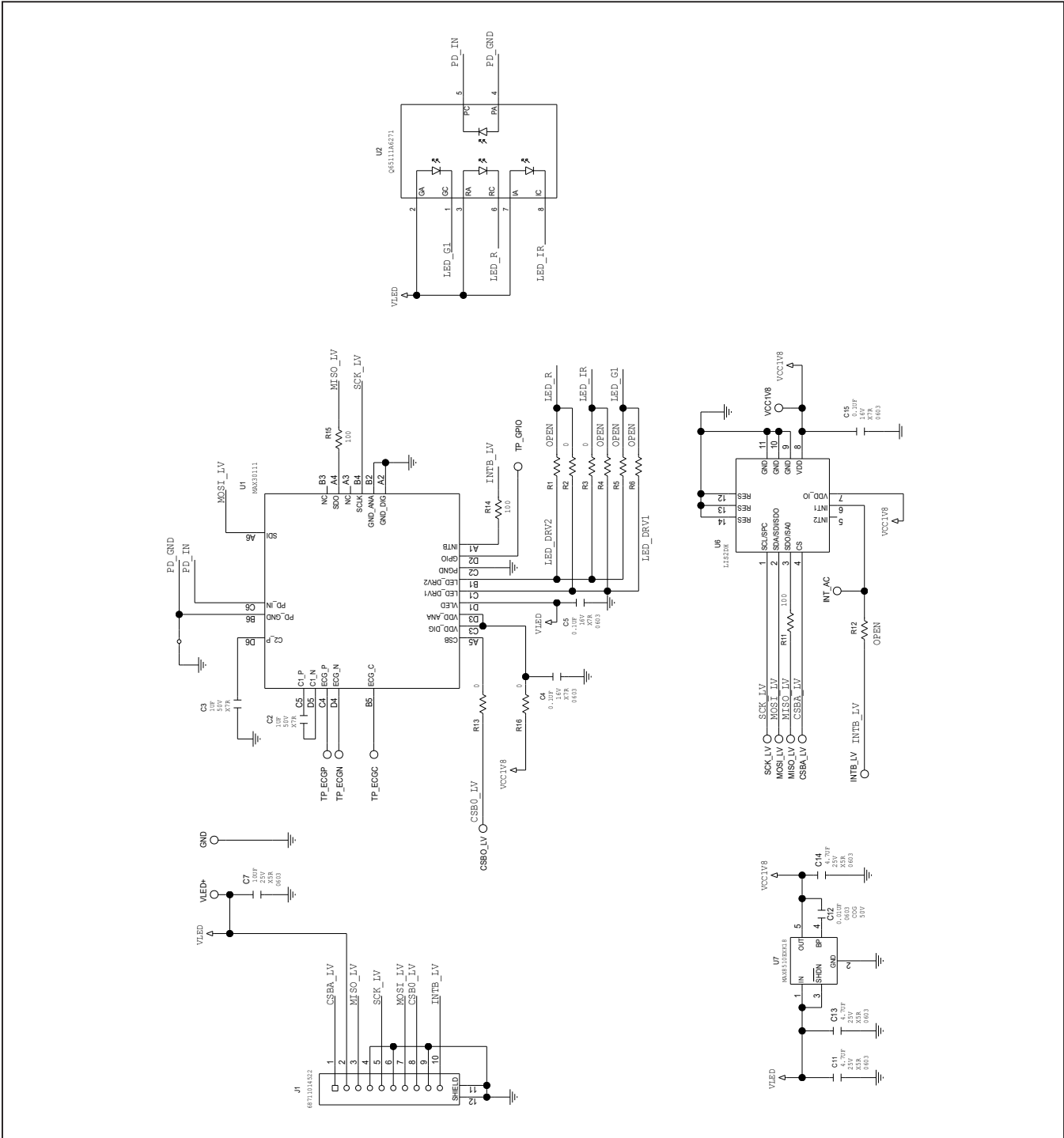



MAX30110 EV Kit PCB Layouts

MAX30110\_UC\_EVKIT

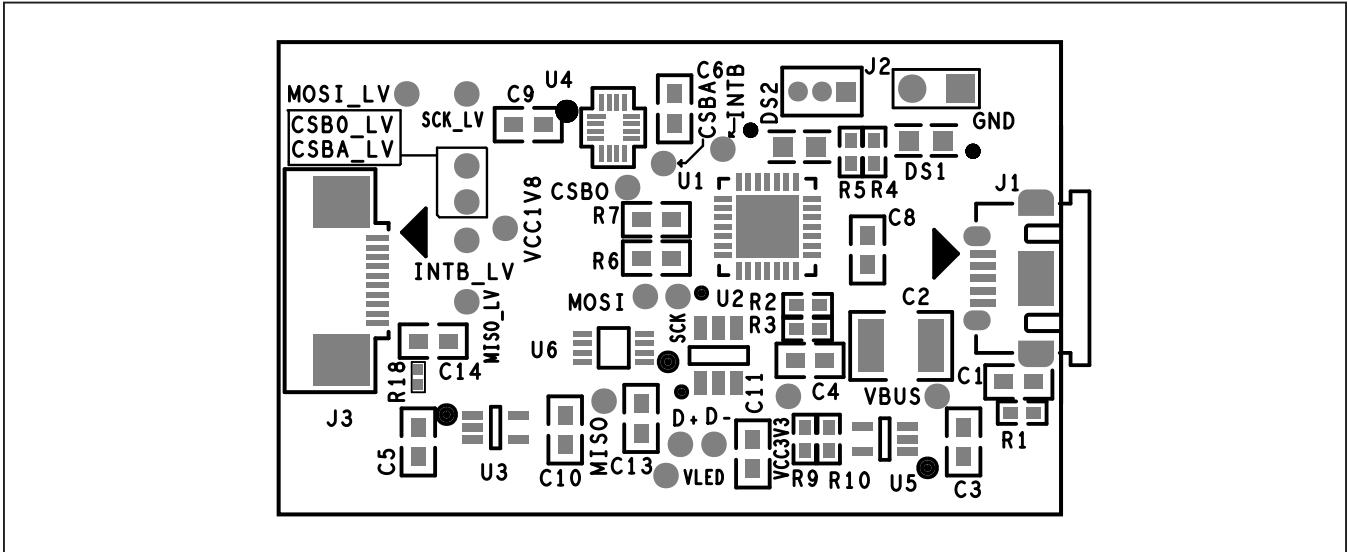

MAX30110 EV Kit—Top Silkscreen

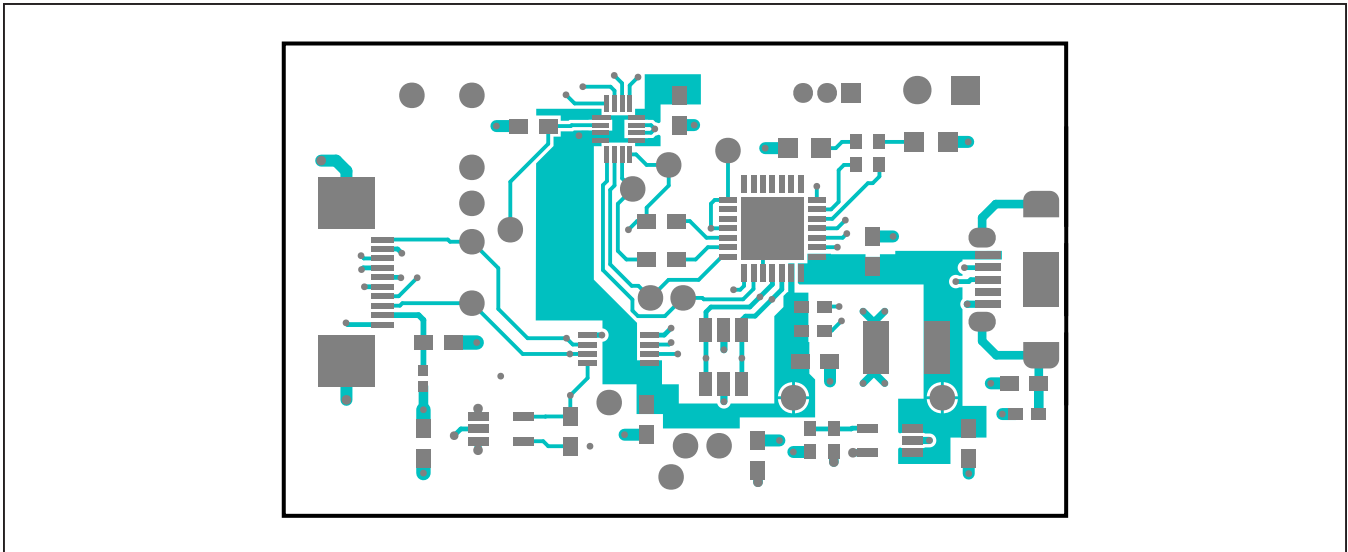

MAX30110 EV Kit—Top

**MAX30110 EV Kit PCB Layouts (continued)**

**MAX30110\_UC\_EVKIT (continued)**

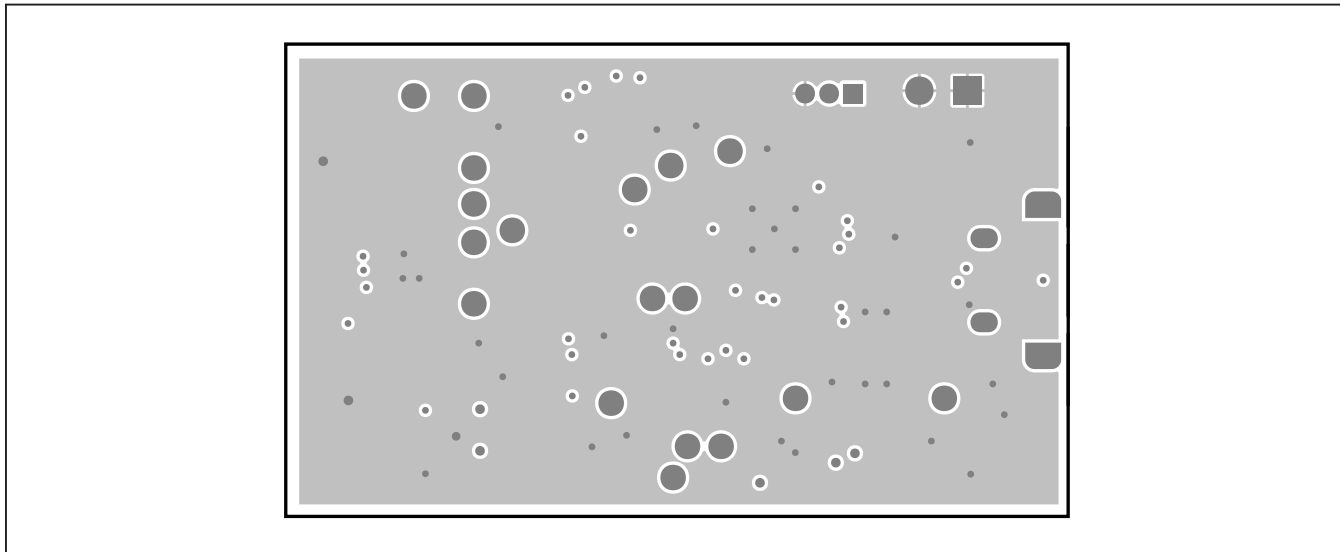

MAX30110 EV Kit—Level 2 GND

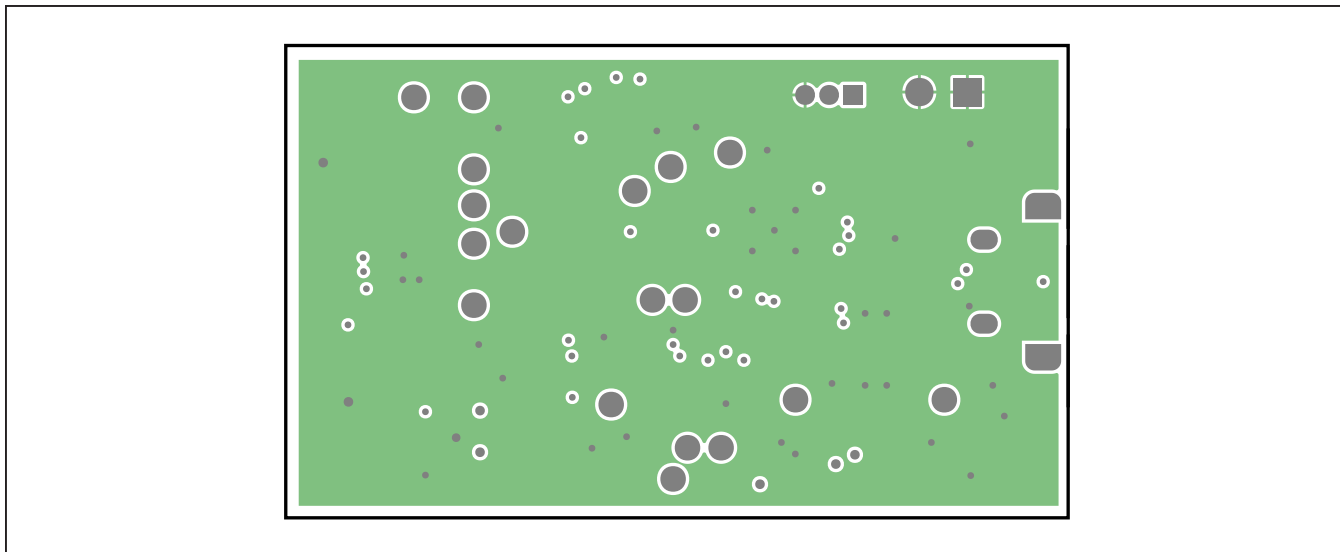

MAX30110 EV Kit—Level 3 GND

**MAX30110 EV Kit PCB Layouts (continued)**

**MAX30110\_UC\_EVKIT (continued)**

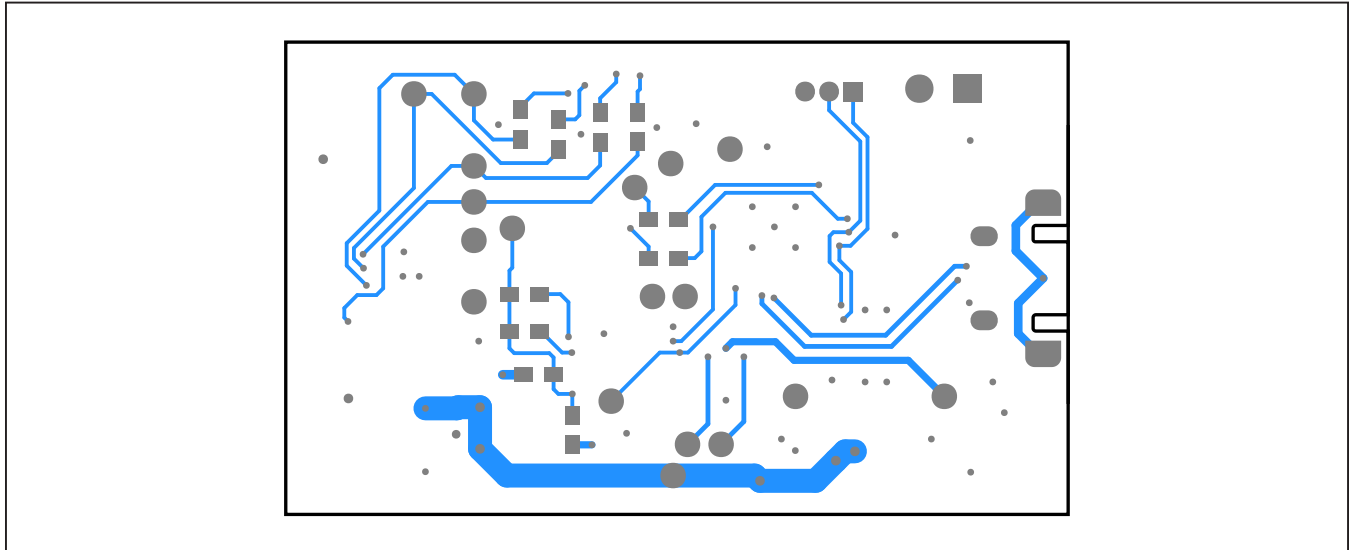

MAX30110 EV Kit—Bottom

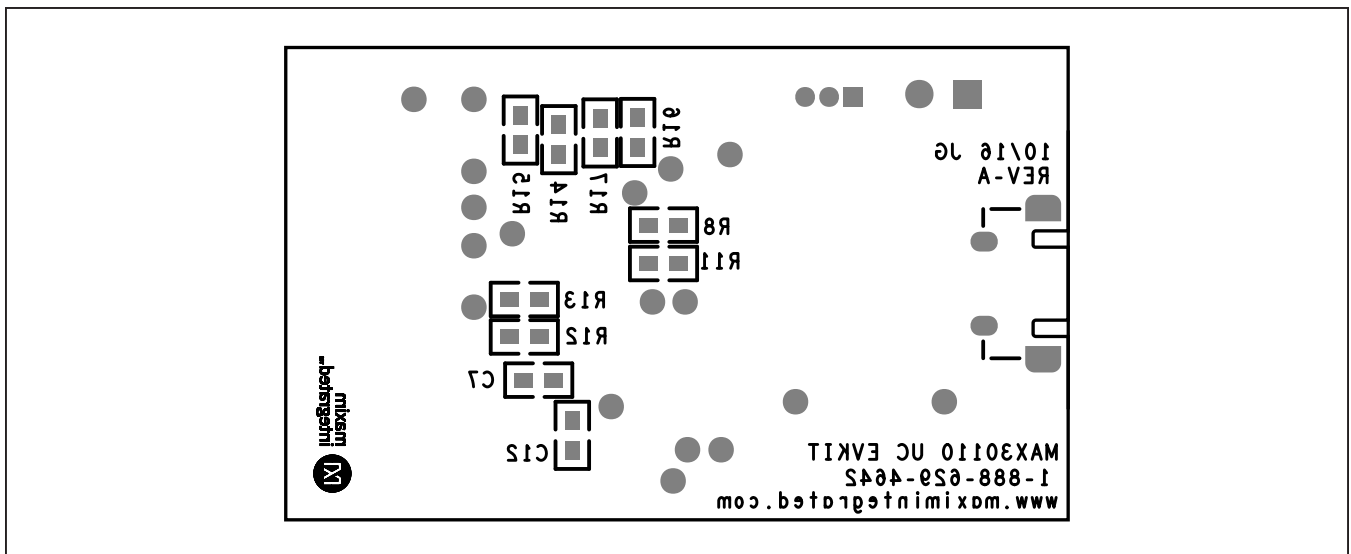

MAX30110 EV Kit—Bottom Silkscreen

**MAX30110 EV Kit PCB Layouts (continued)**

**MAX30110\_OSB\_EVKIT**

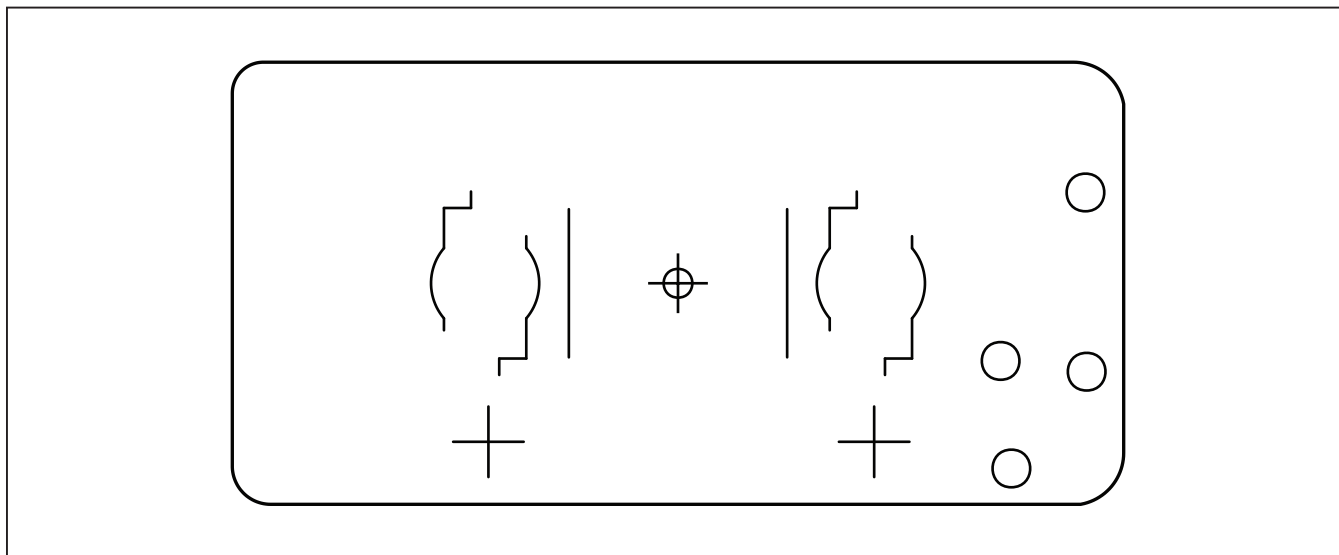

MAX30110 EV Kit—Top Silkscreen

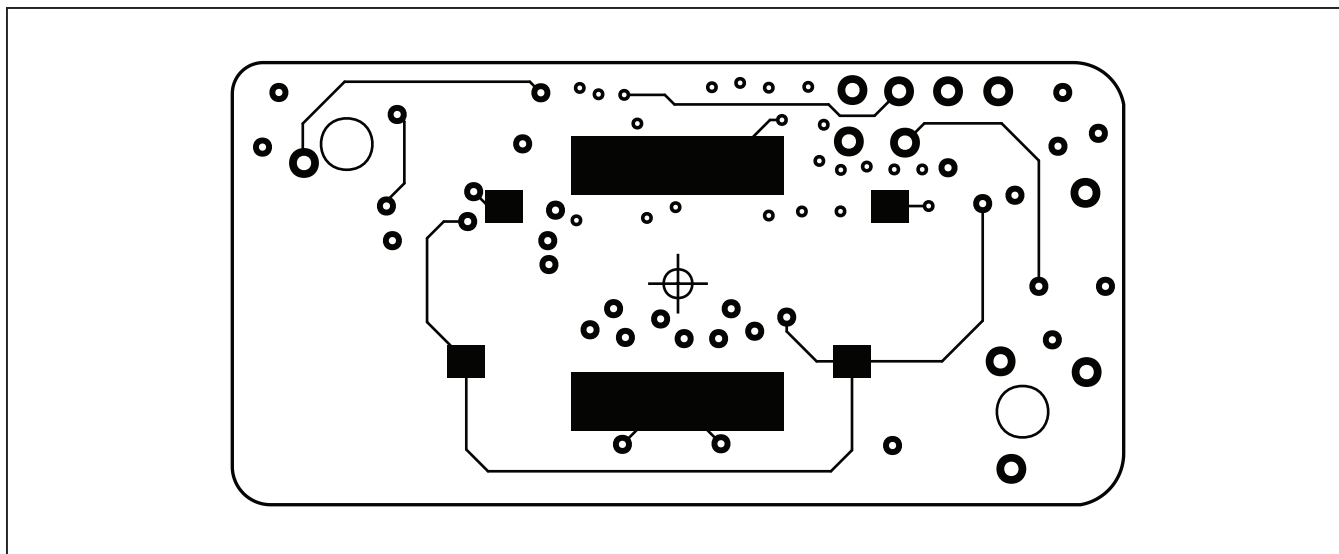

MAX30110 EV Kit—Top

**MAX30110 EV Kit PCB Layouts (continued)**

**MAX30110\_OSB\_EVKIT (continued)**

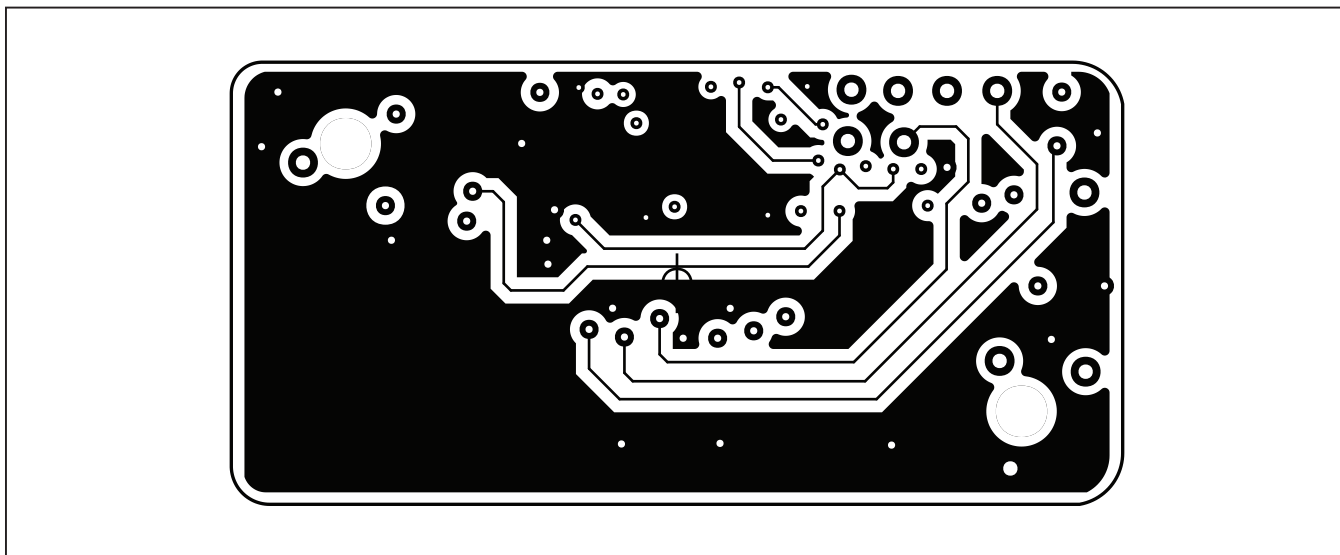

MAX30110 EV Kit—Level 2 SIGS

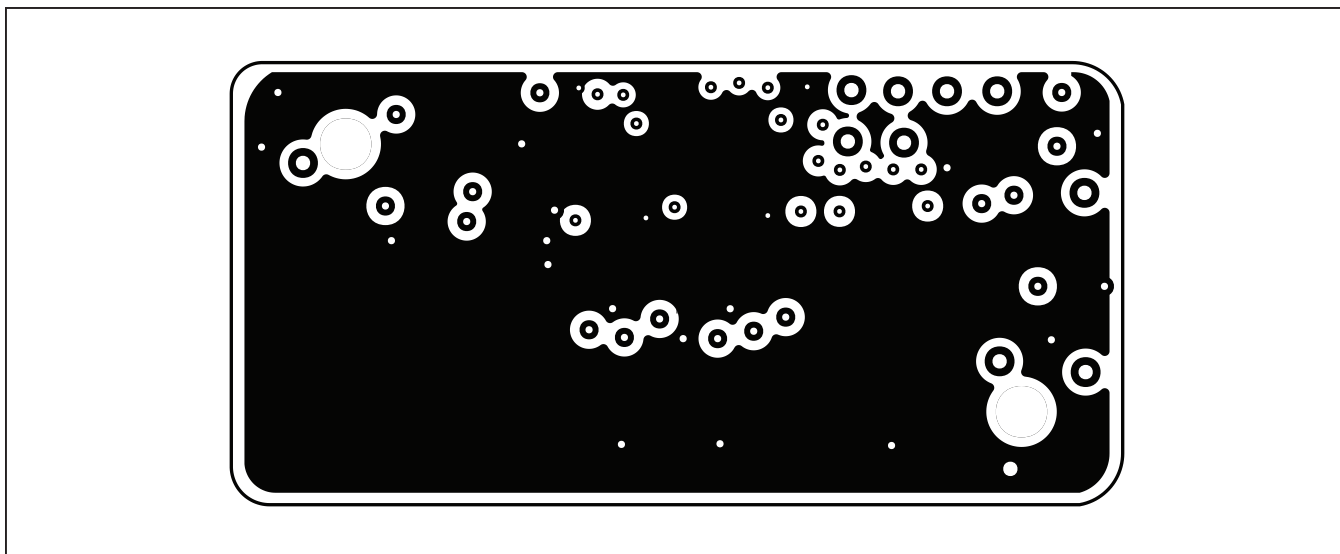

MAX30110 EV Kit—Level 3 GND

**MAX30110 EV Kit PCB Layouts (continued)**

**MAX30110\_OSB\_EVKIT (continued)**

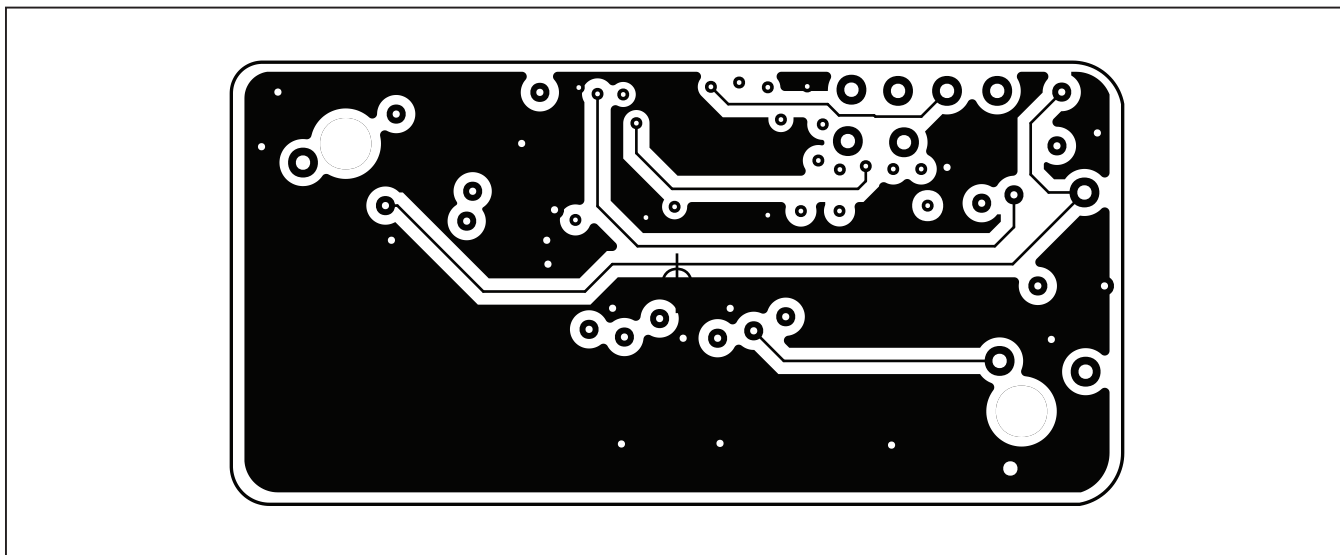

MAX30110 EV Kit—Level 4 SIGS

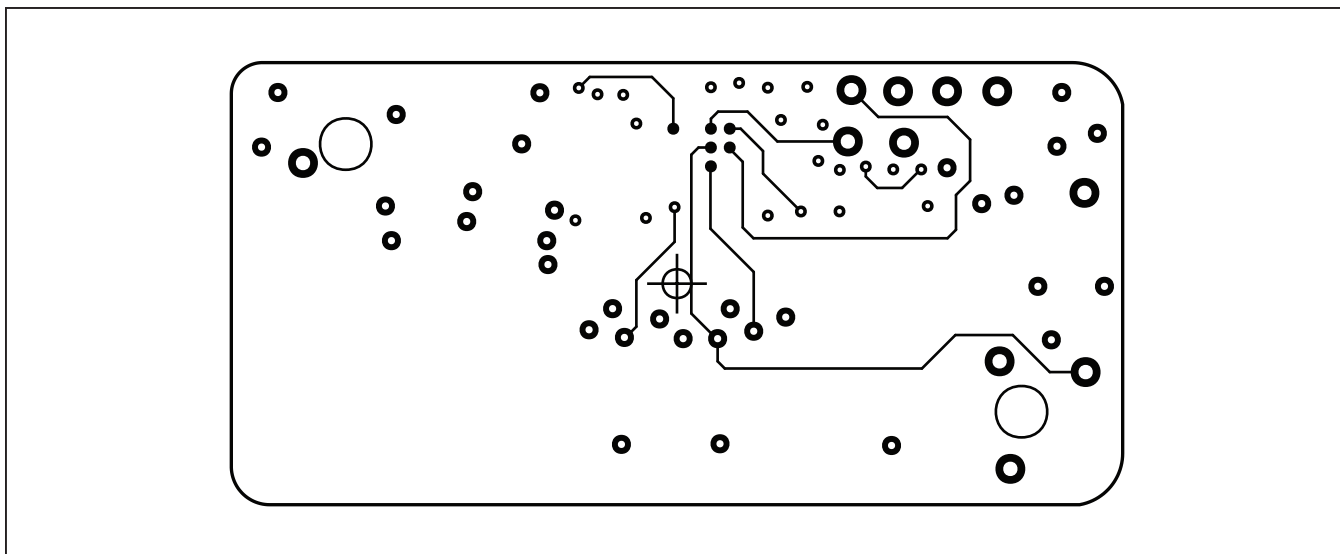

MAX30110 EV Kit—Level 5 SIGS

**MAX30110 EV Kit PCB Layouts (continued)**

**MAX30110\_OSB\_EVKIT (continued)**

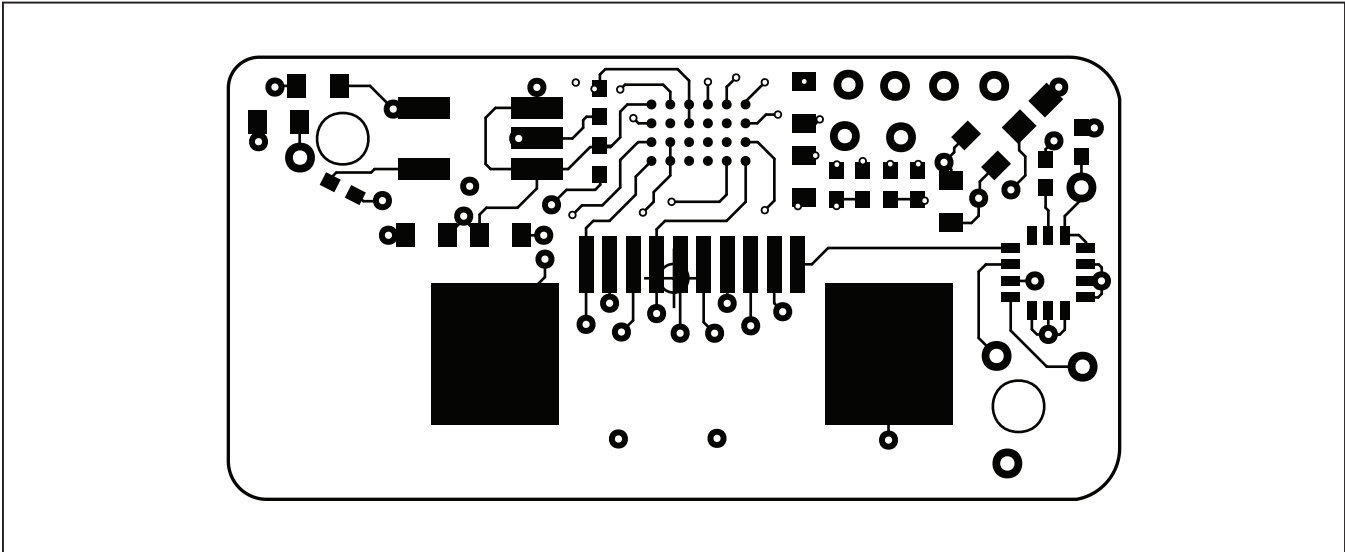

MAX30110 EV Kit—Bottom

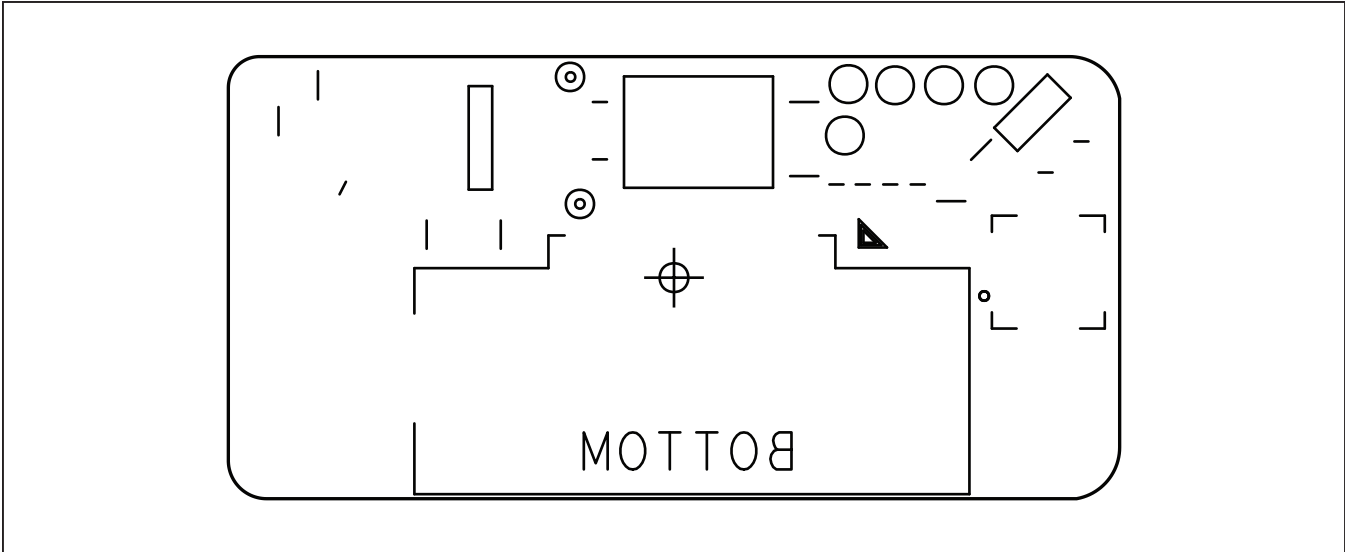

MAX30110 EV Kit—Bottom Silkscreen

**MAX30110 EV Kit PCB Layouts (continued)**

**MAX30110\_SF7050\_EVKIT**

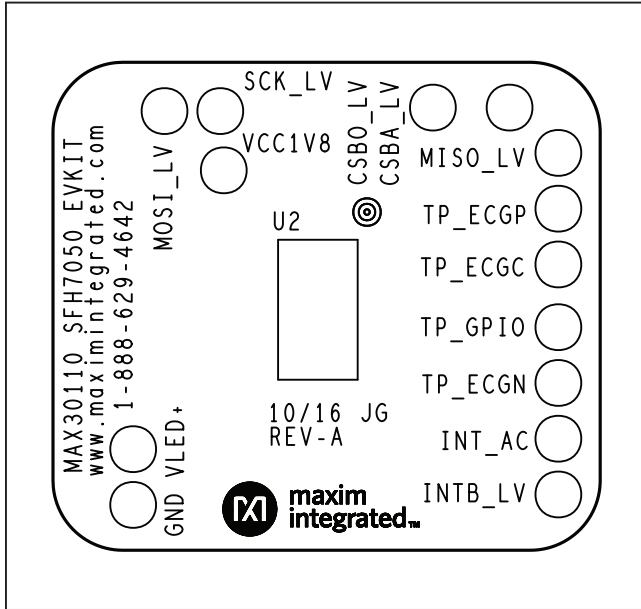

MAX30110 EV Kit—Top Silkscreen

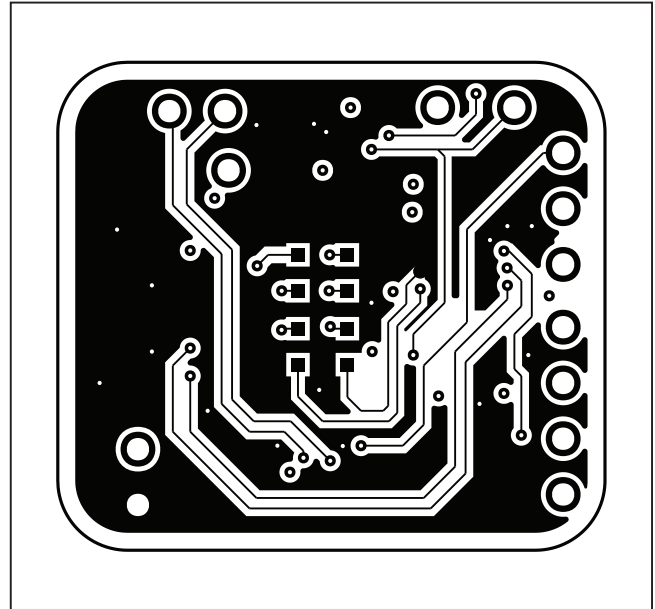

MAX30110 EV Kit—Top

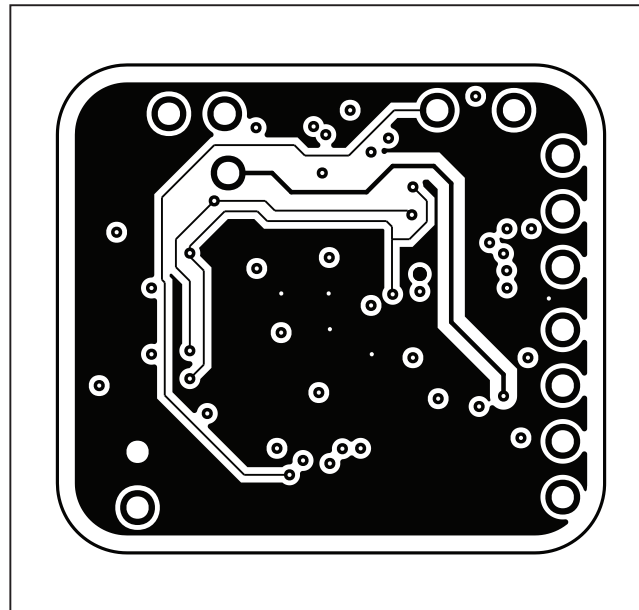

MAX30110 EV Kit—Power



**MAX30110 EV Kit PCB Layouts (continued)**

**MAX30110\_SF7050\_EVKIT (continued)**

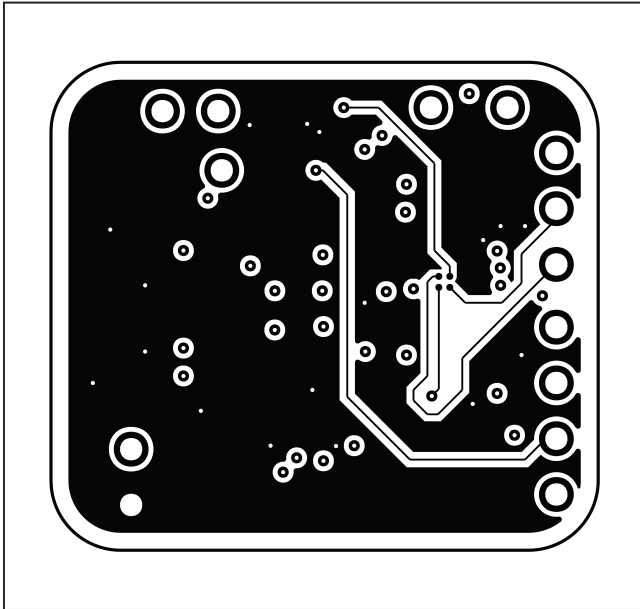

MAX30110 EV Kit—GND

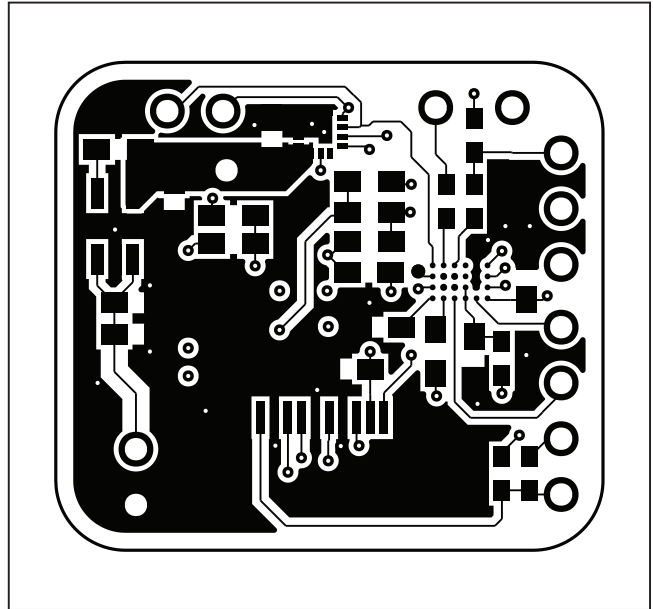

MAX30110 EV Kit—Bottom

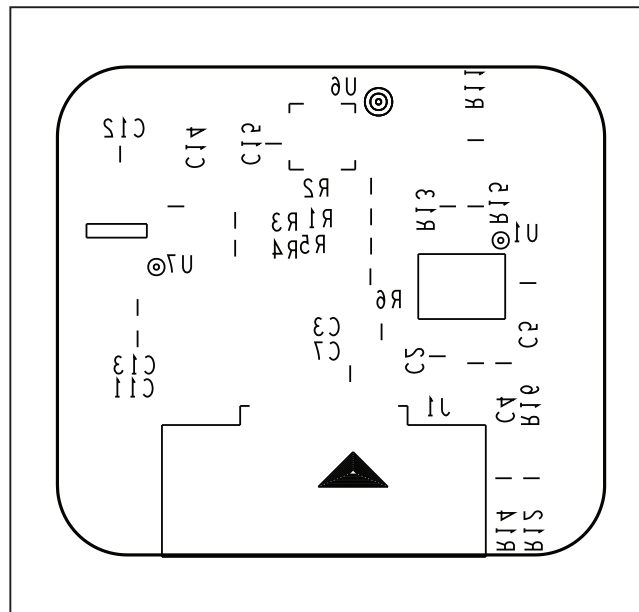

MAX30110 EV Kit—Bottom Silkscreen

## Component List

### MAX30110 EV Kit

PART	QTY	DESCRIPTION
MAX30110_UC_EVKIT	1	MAX30110 EV Kit Micro PCB
MAX30110_OSB_EVKIT	1	MAX30110 EV Kit Sensor PCB 1
MAX30110_SF7050_ EVKIT	1	MAX30110 EV Kit Sensor PCB 2

## Ordering Information

PART	TYPE
MAX30110ACCEVKIT#	EVKIT

#Denotes RoHS compliant.

## Revision History

REVISION NUMBER	REVISION DATE	DESCRIPTION	PAGES CHANGED
0	6/17	Initial release	—
1	7/17	Updated orderable part number in <i>Ordering Information</i> table	26

For pricing, delivery, and ordering information, please contact Maxim Direct at 1-888-629-4642, or visit Maxim Integrated's website at [www.maximintegrated.com](http://www.maximintegrated.com).

*Maxim Integrated cannot assume responsibility for use of any circuitry other than circuitry entirely embodied in a Maxim Integrated product. No circuit patent licenses are implied. Maxim Integrated reserves the right to change the circuitry and specifications without notice at any time.*