

KEMET Part Number: HVZ0E107NF-LT
(USCHVZ0E107NU0)

Supercapacitors, Snap-In, Commercial Grade, HVZ, 100 F, 30%, 2.7 V, 2 Pin, 10mm

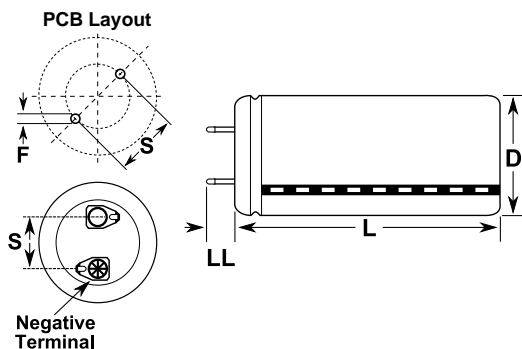

Dimensions	
D	25mm +1mm
L	50mm +2mm
S	10mm +/-0.5mm
F	2mm +/-0.1mm

Packaging Specifications	
Lead:	2 Pin
Packaging:	Bulk
Packaging Quantity:	200

General Information	
Series:	HVZ
Description:	Radial Cylindrical Double Layer Capacitor
RoHS:	Yes

Specifications	
Capacitance:	100 F
Capacitance Tolerance:	30%
Voltage DC:	2.7 VDC
Temperature Range:	-25/+60C
Rated Temperature:	60C
Resistance:	30 mOhms (1kHz)
Current:	81 mAmps (30min)