

Product Data Sheet 4312 N/17MT

**ebmpapst**

The engineer's choice



## 4312 N/17MT

## INDEX

<b>1</b>	<b>General</b> .....	<b>3</b>
<b>2</b>	<b>Mechanics</b> .....	<b>3</b>
2.1	General.....	3
2.2	Connections.....	3
<b>3</b>	<b>Operating Data</b> .....	<b>5</b>
3.1	Electrical Interface - Input.....	5
3.2	Electrical Operating Data .....	6
3.3	Electrical Interface - Output.....	7
3.4	Electrical Features.....	8
3.5	Aerodynamics.....	9
3.6	Sound Data.....	11
<b>4</b>	<b>Environment</b> .....	<b>11</b>
4.1	General.....	11
4.2	Climatic Requirements .....	11
4.3	Mechanical Requirements.....	11
<b>5</b>	<b>Safety</b> .....	<b>13</b>
5.1	Electrical Safety.....	13
5.2	Approval Tests .....	13
<b>6</b>	<b>Reliability</b> .....	<b>13</b>
6.1	General.....	13

## 1 General

Fan type	Fan	
Rotating direction looking at rotor	Clockwise	
Airflow direction	Air outlet over struts	
Bearing system	Ball bearing	
Mounting position - shaft	Any	

## 2 Mechanics

### 2.1 General

Width	119,0 mm	
Height	119,0 mm	
Depth	32 mm	
Mass	0,23 kg	
Housing material	Plastic	
Impeller material	Plastic	
Max. torque when mounted across both mounting flanges	Wire outlet corner: 80 Ncm Remaining corners: 80 Ncm	
Screw size	ISO 4762 - M4 degreased, without an additional brace and without washer	
Rotor protrusion max.	0,4 mm	

### 2.2 Connections

Electrical connection	Wires	
Lead wire length	L = 310 mm	
Tolerance	+ - 10,0 mm	
Wire size (AWG)	24	
Insulation diameter	1,1 mm	

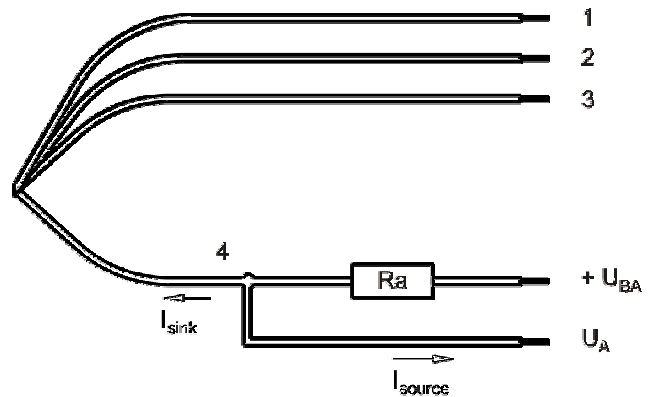

Wire	Color	Operation
1	red	+ UB
2	blue	- GND
3	violet	NTC
4	white	Alarm

The auxiliaries shown on the schematic diagram (which are required for the intended use) are not part of our delivery.

3 Operating Data

3.1 Electrical Interface - Input

Control input	External Temperature Sensor
---------------	-----------------------------

Features

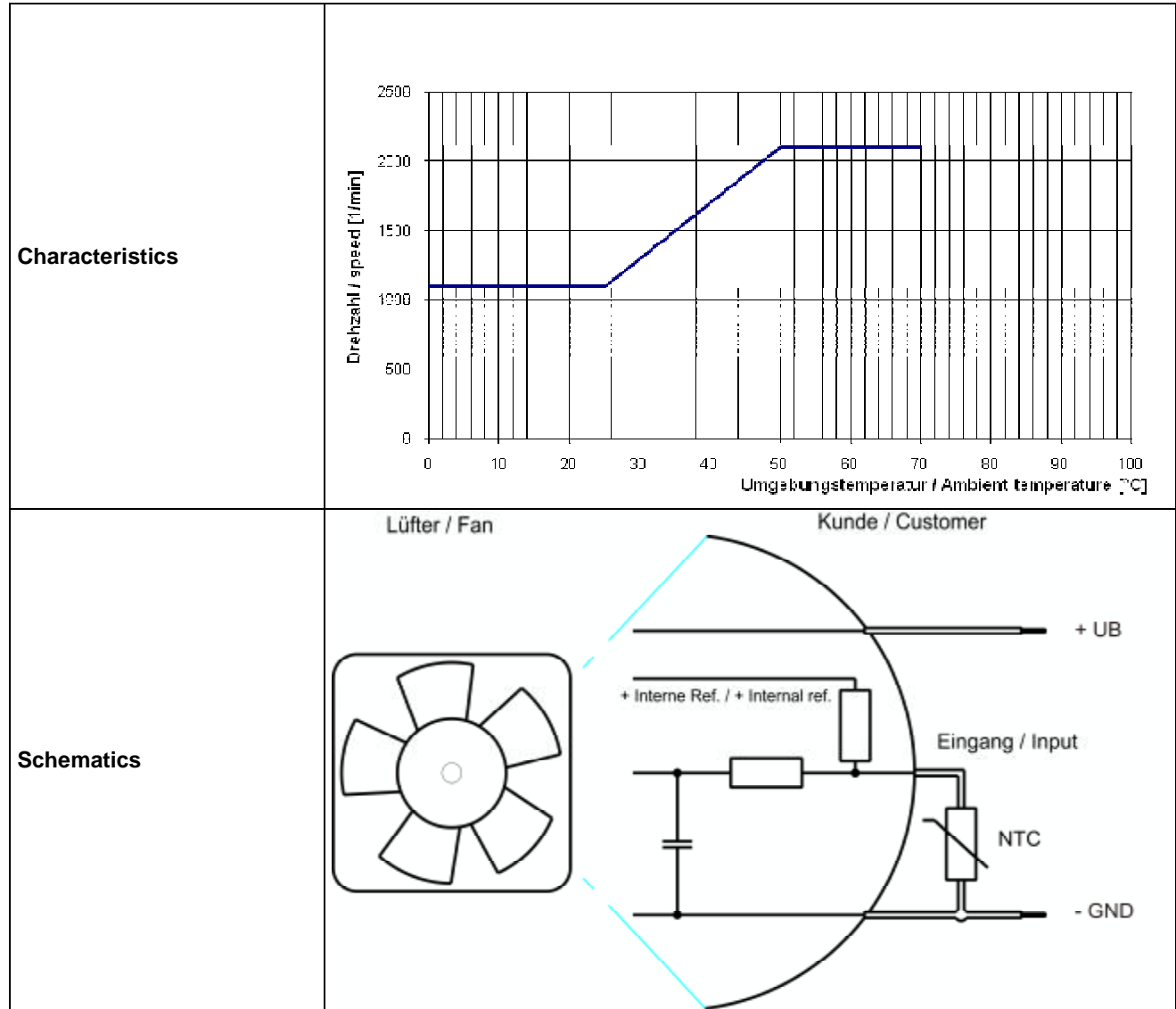

### 3.2 Electrical Operating Data

Measurement conditions: Normal air density = 1,2 kg/m<sup>3</sup>; Temperature 23°C +/- 3°C; Motor axis horizontal; warm-up time before measuring 5 minutes (unless otherwise specified). In the intake and outlet area should not be any solid obstruction within 0,5 m.

$\Delta p = 0$ : corresp. to free air flow (see chapter aerodynamics)  
 I: corresp. to arithm. mean current value

Name	Condition
TU 0001	
NTC 0001	NTC <= 33 kOhm

Features	Condition	Symbol	Values		
Voltage range		U	8 V		15 V
Nominal voltage		$U_N$		12 V	
Power consumption	$\Delta p = 0$	P	0,8 W	1,9 W	2,1 W
Tolerance	TU / NTC 0010		+/- 17,5 %	+/- 25 %	+/- 25 %
Current consumption	$\Delta p = 0$	I	100 mA	160 mA	138 mA
Tolerance	TU / NTC 0010		+/- 17,5 %	+/- 25 %	+/- 25 %
Speed	$\Delta p = 0$	n	1.470 1/min	2.100 1/min	2.100 1/min
Tolerance	TU / NTC 0010		+/- 12,5 %	+/- 6 %	+/- 6 %
Starting current consumption				780 mA	

3.3 Electrical Interface - Output

Alarm type	/17 (high = ok, open collector)
------------	---------------------------------

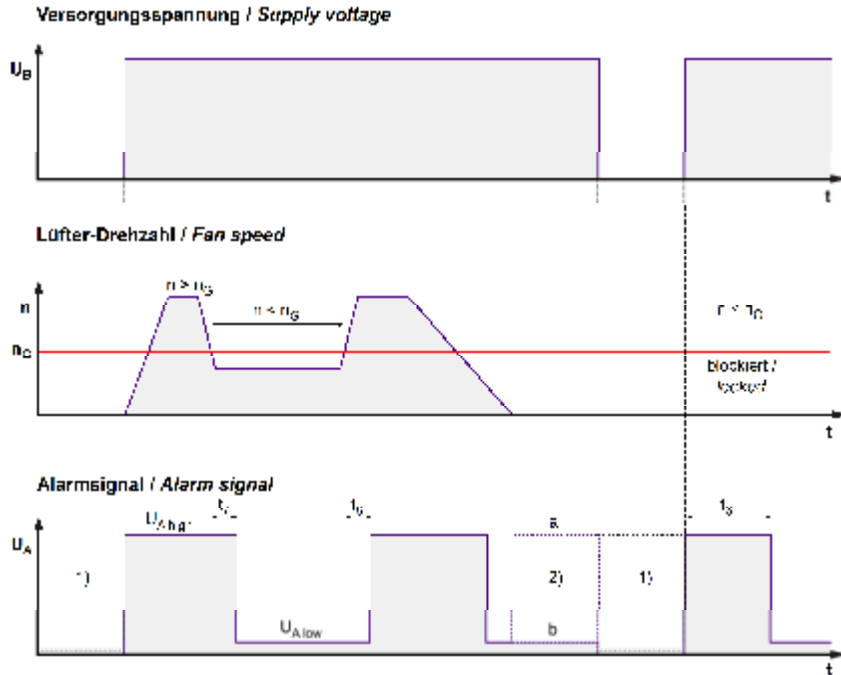

$$R_a = \frac{U_{BA} - U_{A,low}}{I_{sink}}$$

Lüfter / Fan      Kunde / Customer

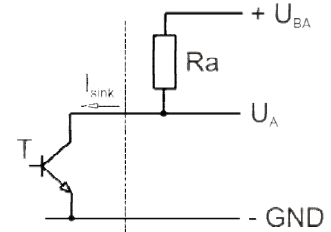

1) Wenn der Lüfter abgeschaltet ist, hängt der Zustand des Ausgangssignals  $U_A$  von der Kundenapplikation ab.  
 When the fan is powered off, the output signal  $U_A$  depends on the customer's application.  
 2) Für den gültigen Zustand (a oder b) siehe Alarmunterbrechung in der Tabelle.  
 For the valid condition (a or b) see alarm suppression in the table.

Features	Note	Values
Alarm operating voltage	$U_{BA}$	$\leq 60\text{ V}$
Alarm signal Low	$U_{A,low}$	$\leq 0,4\text{ V}$
Alarm signal High	$U_{A,high}$	$60\text{ V}$
Maximum sink current	$I_{sink}$	$20\text{ mA}$
External resistor	External resistor $R_a$ from $U_{BA}$ to $U_A$ required. All voltage measured to GND.	
Alarm start-up delay time	$t_6$	$\leq 10\text{ s}$
Alarm trip speed limit	$n_G$	$800\text{ 1/min}$
Alarm trip speed limit hysteresis	$n_{G,Hys}$	$100\text{ 1/min}$
Alarm at sense failure	No	
Alarm latch	No	
Alarm isolated from motor	No	

### 3.4 Electrical Features

Electronic function	Speed-Controlled	
Reversed polarity protection	Rectifying diode	
Max. residual current at $U_N$	$I_F < 100 \mu A$	
Locked rotor protection	Auto restart	
Locked rotor current at $U_N$	$I_{block}$ approx. 750 mA	
Clock signal at locked rotor	$t_3 / t_4$ typical: 1 s / 10 s	

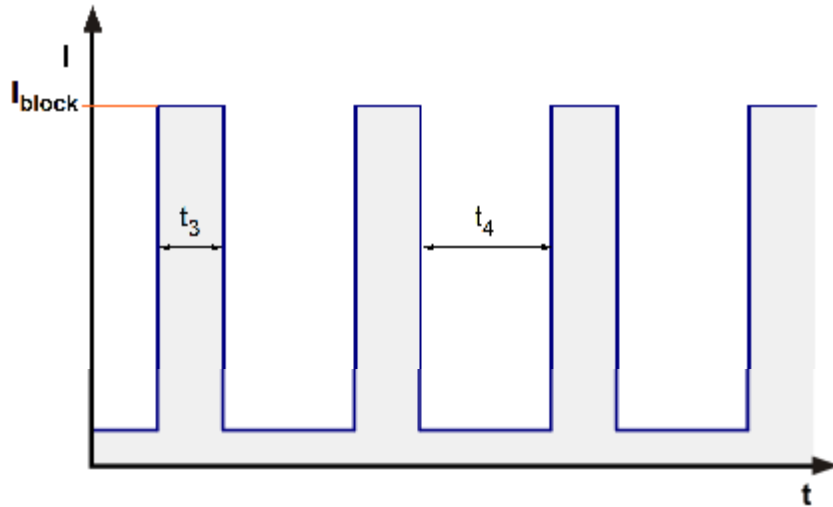



### 3.5 Aerodynamics

Measurement conditions:

Measured with a double chamber intake rig acc. to DIN EN ISO 5801.  
 Normal air density = 1,2 kg/m<sup>3</sup>; Temperature 23°C +/- 3°C;  
 In the intake and outlet area should not be any solid obstruction within 0,5 m. Motor shaft horizontal.  
 The information is only valid under the specified test conditions and may be changed by the installation conditions. If there are deviations from the standard test conditions, the characteristic values must be checked under the installed conditions. Power consumption of the fan motor when operating at normal voltage is shown. Depending on the operating conditions of the application, the power input may be higher.

a.) Operation condition:

2.100 1/min at free air flow	NTC <= 33 kOhm		
------------------------------	----------------	--	--

Max. free-air flow ( $\Delta p = 0 / \dot{V} = \text{max.}$ )	148 m <sup>3</sup> /h	
Max. static pressure ( $\Delta p = \text{max.} / \dot{V} = 0$ )	44 Pa	

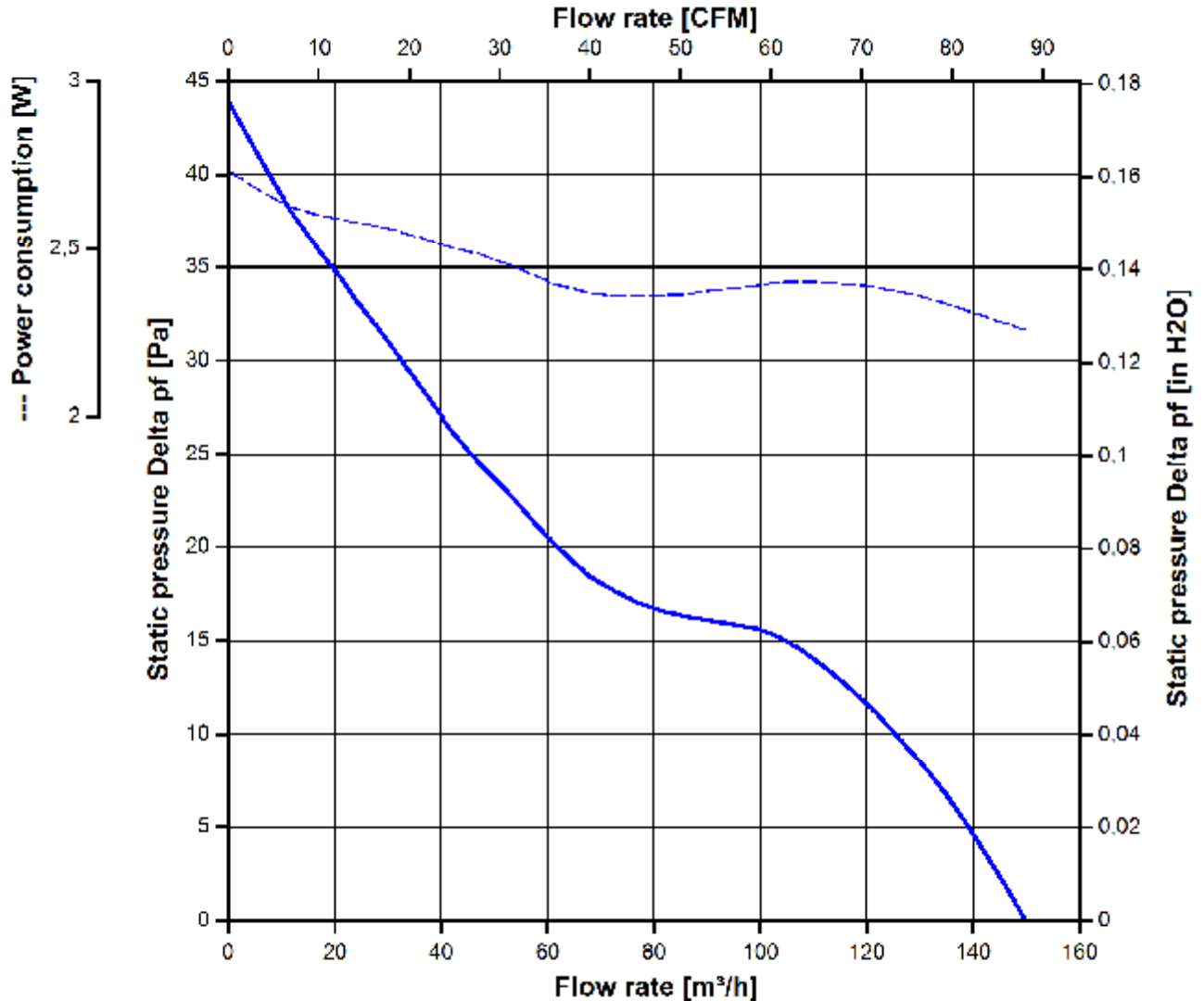



### 3.6 Sound Data

Measurement conditions: Sound pressure level: 1 meter distance between microphone and the air intake.  
 Sound power level: Acc. to DIN 45635 part 38 (ISO 10302)  
 Measured in a semianchoic chamber with a background noise level of  $L_p(A) < 5 \text{ dB(A)}$   
 For further measurement conditions see chapter aerodynamics.

a.) Operation condition:

2.100 1/min at free air flow	NTC $\leq 33 \text{ kOhm}$		
------------------------------	----------------------------	--	--

Optimal operating point	110 m <sup>3</sup> /h @ 14 Pa	
Sound power level at the optimal operating point	4,7 bel(A)	
Sound pressure level at free air flow, measured in rubber bands	36 dB(A)	

## 4 Environment

### 4.1 General

Min. permitted ambient temperature TU min.	-20 °C	
Max. permitted ambient temperature TU max.	70 °C	
Min. permitted storage temperature TL min.	-40 °C	
Max. permitted storage temperature TL max.	80 °C	

### 4.2 Climatic Requirements

Humidity requirements	humid heat, constant; according to DIN EN 60068-2-78, 14 days	
Water exposure	None	
Dust requirements	None	
Salt fog requirements	None	

Permitted application area:

The product is intended for use in sheltered rooms with controlled temperature and controlled humidity. Directly exposure to water must be avoided.

Pollution degree 1 (according DIN EN 60664-1)

There is either no pollution or it occurs only dry, non-conductive pollution. The pollution has no negative impact.

### 4.3 Mechanical Requirements

severity level	Vibration (sinusoidal)	
0,5 G	Vibration (sinusoidal) in use IEC 60068-2-6 Displacement / frequency range Acceleration / frequency range Sweep rate Sweep cycles	Vibration (sinusoidal) 0,035 mm / 10-60, 60-10 Hz 0,5 G / 60-500-60 Hz 1 Oct./min 10

Duration	2 hrs.
Axes of vibration	3

severity level	stationary use		
1	storage / transportation	Random vibration not in use IEC 60068-2-64 Frequency range / ASD  $G_{RMS}$ Axes of vibration Test duration	Random vibration 5 - 20 Hz : $1,0 \text{ m}^2 / \text{s}^3$ 20 - 500 Hz : - 3 dB / Oct 0,91 G 3 3 x 30 min
	storage / transportation	Bump not in use IEC 60068-2-29 Shock spectrum Acceleration Duration Number of bumps (+X, -X, -Y, +Y, -Z, +Z) Total bumps	Bump half sine 18 G 6 ms 100 in each direction 600
	stationary use	Random vibration in use IEC 60068-2-64 Frequency range / ASD  $G_{RMS}$ Axes of vibration Test duration	Random vibration 5 - 10 Hz : +6 dB / Oct 10 - 50 Hz : $1,0 \text{ m}^2 / \text{s}^3$ 50 - 200 Hz : - 6 dB / Oct 0,65 G 3 3 x 30 min
	stationary use	Bump in use IEC 60068-2-29 Shock spectrum Acceleration Duration Number of bumps (+X, -X, -Y, +Y, -Z, +Z) Total bumps	Bump half sine 5 G 11 ms 100 in each direction 600

## 5 Safety

### 5.1 Electrical Safety

Dielectric strength DIN EN 60950 (VDE 0805) and DIN EN 60335 (VDE 0700) A.) Type test Measuring conditions: After 48h of storage at 95% R.H. and 25°C. No arcing or breakdown is allowed! All connections together to ground.	500 VAC / 1 Min.	
B.) Routine test Measuring conditions: At indoor climate. No arcing or breakdown is allowed! All connections together to ground.	Not applicable	
Isolation resistance Measuring conditions: After 48h of storage at 95% R.H. and 25°C measured with U=500 VDC for 1 min.	RI > 10 MOhm	
Clearance / creepage distance	1,0 mm / 1,2 mm	
Protection class	III	

### 5.2 Approval Tests

CE	EC Declaration of Conformity	Yes
EAC	Eurasian Conformity	Yes
UL	Underwriters Laboratories	Yes / UL507, Electric Fans
VDE	Association for Electrical, Electronic and Information Technologies	Yes / Approval acc. to EN 60950 (VDE 0805) - Information technology equipment
CSA	Canadian Standards Association	Yes / C22.2 No. 113 Fans and Ventilators
CCC	China Compulsory Certification	Not applicable

## 6 Reliability

### 6.1 General

Life expectancy L10 at TU = 40 °C	85.000 h	
Life expectancy L10 at TU max.	42.500 h	
Life expectancy L10 acc. to IPC 9591 at TU = 40 °C	142.500 h	

Sealing of this document, and ability to verify the use or administration of the content thereof, are provided without express warranty. Offenders are liable to the payment of damages. All rights are reserved in the event of the print or a further or the registration of a utility model or design.

Software wird zur ENEC 2015 basieren /  
 Refer to product notes EN 2015 (EN 1)

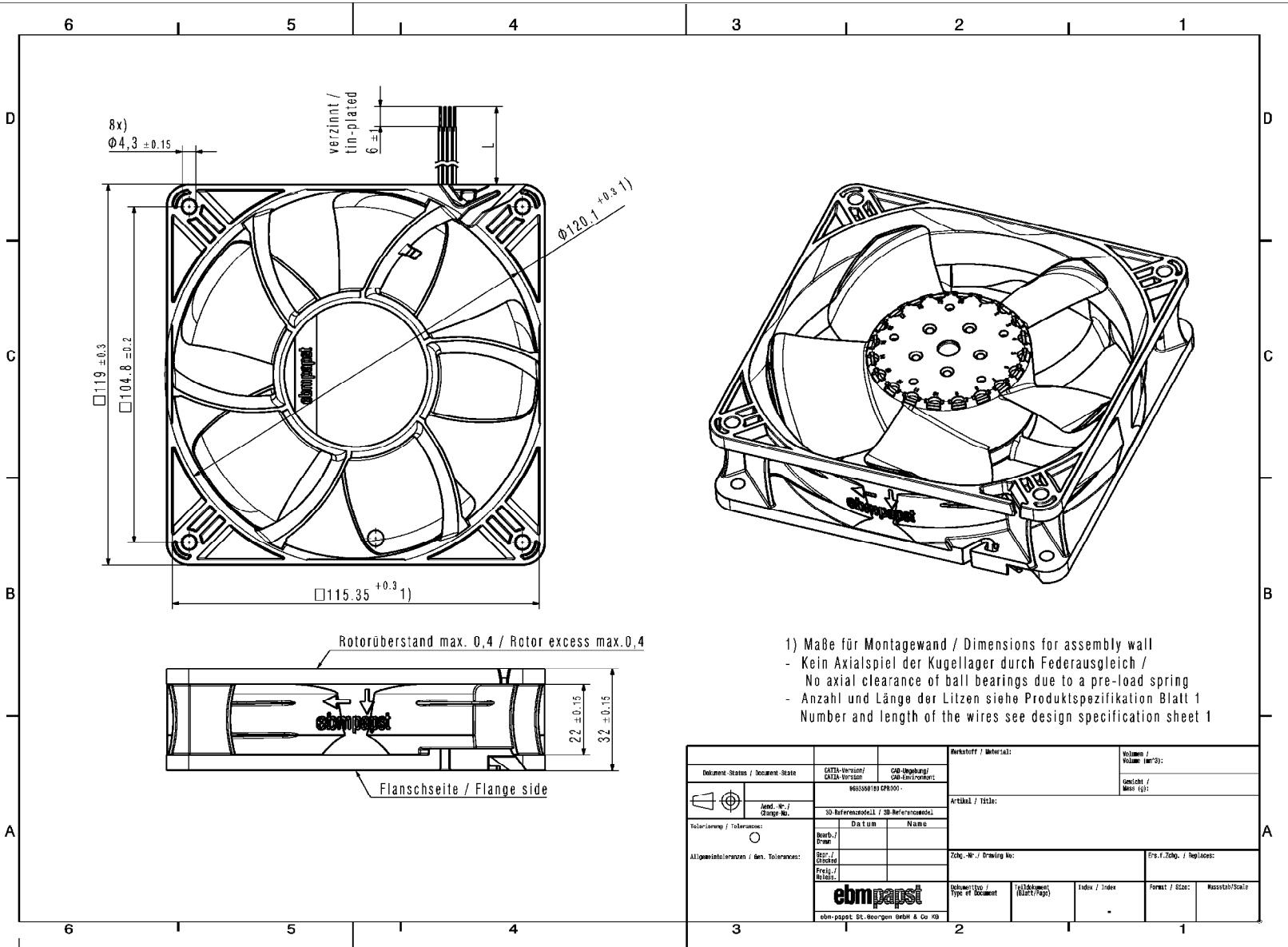

- 1) Maße für Montagewand / Dimensions for assembly wall  
 - Kein Axialspiel der Kugellager durch Federausgleich /  
 No axial clearance of ball bearings due to a pre-load spring  
 - Anzahl und Länge der Litzen siehe Produktspezifikation Blatt 1  
 Number and length of the wires see design specification sheet 1

Dokument Status / Document State		CATIA-Version / CATIA-Version		CAD-Umgebung / CAD-Environment		Reinhalteff. / Material:		Volumen / Volume [cm³]:	
865580101 EPB1000								Gewicht / Mass [g]:	
Änd.-Nr. / Change No.		3D-Referenzcode1 / 3D-Referenzcode2:		Datum		Name		Artikel / Title:	
Tolerierung / Tolerances:		Reib- / Draw:						Zug.-Nr. / Drawing No:	
Allgemeintoleranzen / Gen. Tolerances:		Spez- / Specify:						Frei- / Release:	
		Freig- / Release:						Format / Size:	
		ebmpapst		Dokument- / Type of Document		Teilblatt / Sheet/ Page		Index / Index	
		ebmpapst St. Georgen orfB & Co KG						Maßstab / Scale	