

Bus system connector - SACC-M12FRB-2PL SH PB - 1424681

Please be informed that the data shown in this PDF Document is generated from our Online Catalog. Please find the complete data in the user's documentation. Our General Terms of Use for Downloads are valid (<http://phoenixcontact.com/download>)

Bus system connector, PROFIBUS DP (12 Mbps), 2-position, shielded, Socket angled M12 Screw locking, B-coded, Push-in connection, knurl material: Zinc die-cast, nickel-plated, external cable diameter 4 mm ... 8 mm



Why buy this product

- ✓ Safe use in the field, thanks to a high degree of protection
- ✓ Flexible: connectors for on-site assembly
- ✓ Save time, thanks to installation with SPEEDCON fast locking system
- ✓ Spring-cage connection: connect more securely, even in the case of shock and vibration, thanks to high contact forces
- ✓ Reliable signal transmission - 360° shielding in environments with electromagnetic interference
- ✓ Easy tool free wiring with the push-in connection
- ✓ Quick and easy installation, thanks to Push-in connection technology



Key Commercial Data

Packing unit	1 STK
GTIN	 4 055626 376080
GTIN	4055626376080
Weight per Piece (excluding packing)	22.220 g
Custom tariff number	85366990
Country of origin	Germany
Note	Made to Order (non-returnable)

Technical data

Dimensions

External cable diameter	4 mm ... 8 mm
Stripping length of the sheath	34 mm
Stripping length of the individual wire	6 mm

Ambient conditions

Ambient temperature (operation)	-40 °C ... 85 °C (Plug / socket)
---------------------------------	----------------------------------

Bus system connector - SACC-M12FRB-2PL SH PB - 1424681

Technical data

Ambient conditions

Degree of protection	IP65
	IP67

General

Rated current at 40°C	4 A
Rated voltage	60 V DC
	48 V AC
Number of positions	2
Insulation resistance	≥ 100 MΩ
Coding	B-coded
Standards/regulations	M12 connector IEC 61076-2-101
	Shock, vibration EN 50155:2001
Signal type/category	PROFIBUS DP, 12 Mbps
Status display	No
Overvoltage category	II
Degree of pollution	3
Connection method	Push-in connection
Conductor cross section	0.14 mm ² ... 0.75 mm ² (without ferrule)
	0.08 mm ² ... 0.5 mm ² (with ferrule)
	0.14 mm ² ... 0.75 mm ² (solid)
Conductor cross section AWG	26 ... 18 (without ferrule)
	28 ... 20 (with ferrule)
Insertion/withdrawal cycles	≥ 100
Torque	0.4 Nm (M12 knurl)
	0.8 Nm (Connector with coupling sleeve)
	3 Nm (Pressure nut with coupling sleeve)
Assembly instructions	The connector pin assignment can be rotated 45° to the cable outlet
	The wires can be connected both with ferrules and without ferrules

Material

Flammability rating according to UL 94	V0
Contact material	CuSn
Contact surface material	Ni/Au
Contact carrier material	PA 6.6
Material of grip body	Zinc die-cast, nickel-plated
Material, knurls	Zinc die-cast, nickel-plated
Sealing material	NBR

Standards and Regulations

Standard designation	M12 connector
Standards/regulations	IEC 61076-2-101
Standard designation	Shock, vibration

Bus system connector - SACC-M12FRB-2PL SH PB - 1424681

Technical data

Standards and Regulations

Standards/regulations	EN 50155:2001
Flammability rating according to UL 94	V0

Drawings

Schematic diagram

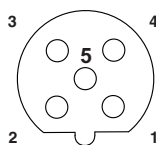

Pin assignment M12 socket, 5-pos., B-coded, female side

Functional drawing

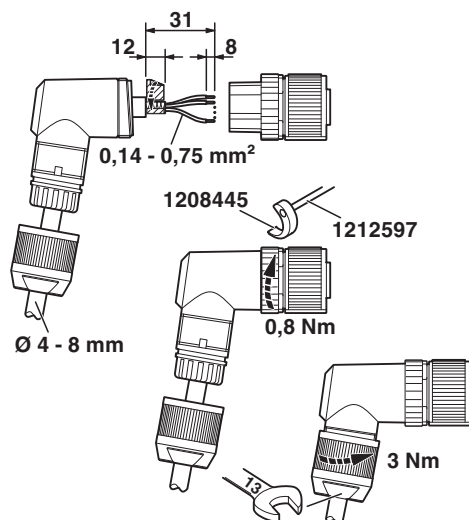

Slide the pressure nut and sleeve housing along the cable, strip the cable, shorten the shield, strip the single wires, connect the wires, in the case of a straight sleeve housing gently twist the wires together, stick the shielding foil around the shortened shield, in the case of a cable outside diameter < 6 mm stick an additional shielding foil around the wire pack, screw the sleeve housing to the plug insert, screw the pressure nut tight.

Dimensional drawing

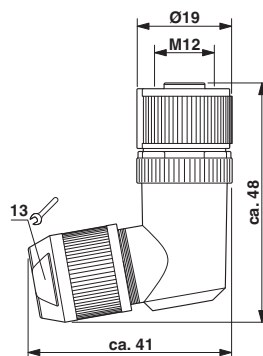

Socket M12-SPEEDCON, angled, shielded

Bus system connector - SACC-M12FRB-2PL SH PB - 1424681

Classifications

eCl@ss

eCl@ss 5.1	27143423
eCl@ss 6.0	27279218
eCl@ss 7.0	27440104
eCl@ss 8.0	27440104
eCl@ss 9.0	27440102

ETIM

ETIM 5.0	EC002635
ETIM 6.0	EC002635

Approvals

Approvals

Approvals

EAC

Ex Approvals

Approval details

EAC		EAC-Zulassung
-----	--	---------------

Accessories

Accessories

Connector

Ferrule - AI 0,25- 6 YE - 3203024



Ferrule, sleeve length: 6 mm, length: 10.5 mm, color: yellow

Bus system connector - SACC-M12FRB-2PL SH PB - 1424681

Accessories

Ferrule - A 0,25- 7 - 3202478



Ferrule, sleeve length: 7 mm, length: 7 mm, color: silver

Ferrule - A 0,34- 7 - 3009202



Ferrule, sleeve length: 7 mm, length: 7 mm, color: silver

Ferrule - A 0,5 - 6 - 3200218



Ferrule, sleeve length: 6 mm, length: 6 mm, color: silver

Ferrule - AI 0,5 - 6 WH - 3200687



Ferrule, sleeve length: 6 mm, length: 12 mm, color: white

Crimping tool

Crimping pliers - CRIMPFOX 6H - 1212046



Crimping pliers, for ferrules without insulating collar according to DIN 46228 Part 1 and ferrules with insulating collar according to DIN 46228 Part 4, 0.14 mm² ... 6 mm², unlockable pressure lock, lateral entry

Data cable by the meter

Bus system connector - SACC-M12FRB-2PL SH PB - 1424681

Accessories

Bus system cable - SAC-2P-910/... - 1511491



Bus system cable, PROFIBUS, 2-position, PUR halogen-free, violet RAL 4001, shielded, free cable end, on free cable end, cable length: Free entry (0.5 ... 400 m)

Protective cap

Screw plug - PROT-M12 MS-PA-CHAIN - 1430899

M12 sealing cap with fixing band, for sensor cables, for free M12 sockets



Screwdriver tools

Tool - SACC BIT M12-D20 - 1208445



Nut for assembling M12 connectors for assembly with a knurl diameter of 20 mm, for 4 mm hexagonal drive

Adapter insert - TSD-M SAC-BIT ADAPTER - 1212600



Adapter bit for TSD-M...torque tools, E6.3-1/4" drive with 4 mm hexagon to accommodate SAC bits

Shield connection

Shielding foil - ALU-SB - 1404531

Shielding foil, for fixing the braided shield of shielded cables. Length: 4 cm, width: 1.2 cm



Stripping tool

Bus system connector - SACC-M12FRB-2PL SH PB - 1424681

Accessories

Stripping tool - WIREFOX 2,5 - 1212368



Stripping tool, for conductors and cables with a conductor cross section from 0.08 to 2.5 mm, self-adjusting, stripping length adjustable up to 15 mm, cutting capacity up to 6 mm² stranded/1.5 mm² solid

Torque tool

Torque screwdriver - TSD 04 SAC - 1208429



Torque screwdriver, with preset torque of 0.4 Nm and 4 mm hexagonal drive for M12 connectors

Torque screwdriver - TSD 08 SAC - 1212597



Torque screw driver with preset torque of 0.8 Nm, with 4 mm hexagon for accommodating SAC bits, two-component handle with non-slip grip

Torque screwdriver - TSD-M 1,2NM - 1212224



Torque screw driver, accuracy as per EN ISO 6789 standard, adjustable from 0.3 - 1.2 Nm

Torque screwdriver - TSD-M 3NM - 1212225



Torque screw driver, accuracy as per EN ISO 6789 standard, adjustable from 1.2 - 3 Nm

Bus system connector - SACC-M12FRB-2PL SH PB - 1424681

Accessories

Stripping tool - VS-CABLE-STRIP-VARIO - 1657407

Stripping tool, for the multi-level stripping of shielded cables



Phoenix Contact 2017 © - all rights reserved
<http://www.phoenixcontact.com>