

# F611 & F612 Series Metallized Polyester Film, 5 – 37.5 mm Lead Spacing, 50 – 1,000 VDC

## Overview

The F611 and F612 Series is constructed of metallized wound or stacked polyester film capacitor with radial leads of tinned wire. Radial leads are electrically welded to the contact metal layer on the ends of the capacitor winding. The capacitor is encapsulated in a self-extinguishing material meeting the requirements of UL 94 V-0.

## Applications

Typical applications include blocking, coupling, decoupling, bypassing and interference suppression in low voltage applications such as automotive. Not for use with the mains.

## Benefits

- Voltage range: 50 – 1,000 VDC
- Capacitance range: 0.001 – 180  $\mu$ F
- Lead spacing: 5 – 37.5 mm
- Capacitance tolerance:  $\pm$ 10%,  $\pm$ 20%,  $\pm$ 5% on request
- Climatic category: 55/105/56, IEC 60068-1
- Tape and reel packaging in accordance with IEC 60286-2
- RoHS Compliant and lead-free terminations
- Operating temperature range of -55°C to +105°C

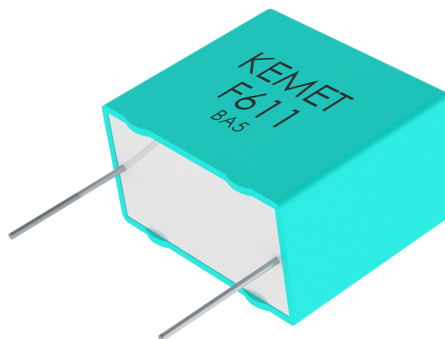

## Part Number System

F	611	J	F	104	M	050	C
Capacitor Class	Series	Lead Spacing (mm)	Size Code	Capacitance Code (pF)	Capacitance Tolerance	Rated Voltage (VDC)	Packaging
F = Film	Metallized Polyester 611 = Wound 612 = Stacked	J = 5 K = 7.5 A = 10.0 B = 15.0 D = 22.5 F = 27.5 R = 37.5	See Dimension Table	First two digits represent significant figures. Third digit specifies number of zeros.	J = $\pm$ 5% K = $\pm$ 10% M = $\pm$ 20%	050 = 50 063 = 63 100 = 100 160 = 160 250 = 250 400 = 400 630 = 630 1K0 = 1,000	See Ordering Options Table

## Ordering Options Table

Lead Spacing Nominal (mm)	Type of Leads and Packaging	Lead Length (mm)	Lead and Packaging Code
5	<b>Standard Lead and Packaging Options</b>		
	Bulk (Bag) – Short Leads	4 +2/-0	C
	Bulk (Bag) – Long Leads	17 +0/-1	A
	Tape & Reel (Standard Reel)	H <sub>0</sub> = 18.5 +/-0.5	L
	<b>Other Lead and Packaging Options</b>		
	Bulk (Bag) – Max Length Leads	20 +5/-0	ALL0L
	Ammo Pack	H <sub>0</sub> = 18.5 +/-0.5	R
7.5	<b>Standard Lead and Packaging Options</b>		
	Bulk (Bag) – Short Leads	4 +2/-0	C
	Bulk (Bag) – Long Leads	17 +0/-1	A
	Tape & Reel (Standard Reel)	H <sub>0</sub> = 18.5 +/-0.5	L
	<b>Other Lead and Packaging Options</b>		
	Bulk (Bag) – Max Length Leads	20 +5/-0	ALL0L
	Ammo Pack	H <sub>0</sub> = 18.5 +/-0.5	R
10	<b>Standard Lead and Packaging Options</b>		
	Bulk (Bag) – Short Leads	4 +2/-0	C
	Bulk (Bag) – Long Leads	17 +0/-1	A
	Tape & Reel (Standard Reel)	H <sub>0</sub> = 18.5 +/-0.5	L
	<b>Other Lead and Packaging Options</b>		
	Bulk (Bag) – Max Length Leads	20 +5/-0	ALL0L
	Ammo Pack	H <sub>0</sub> = 18.5 +/-0.5	R
Tape & Reel (Large Reel)	H <sub>0</sub> = 18.5 +/-0.5	P	
15	<b>Standard Lead and Packaging Options</b>		
	Bulk (Bag) – Short Leads	4 +2/-0	C
	Bulk (Bag) – Long Leads	17 +0/-1	A
	Tape & Reel (Standard Reel)	H <sub>0</sub> = 18.5 +/-0.5	L
	Pizza Pack	4 +2/-0	Z
	<b>Other Lead and Packaging Options</b>		
	Bulk (Bag) – Max Length Leads	25 +5/-0	ALROL
	Ammo Pack	H <sub>0</sub> = 18.5 +/-0.5	R
Tape & Reel (Large Reel)	H <sub>0</sub> = 18.5 +/-0.5	P	

## Ordering Options Table cont'd

Lead Spacing Nominal (mm)	Type of Leads and Packaging	Lead Length (mm)	Lead and Packaging Code
22.5	<b>Standard Lead and Packaging Options</b>		
	Pizza – Long Leads	17 +0/-1	ZLH0J
	Pizza Pack	4 +2/-0	Z
	<b>Other Lead and Packaging Options</b>		
	Tape & Reel (Standard Reel)	$H_0 = 18.5 \pm 0.5$	L
	Tape & Reel (Large Reel)	$H_0 = 18.5 \pm 0.5$	P
	Ammo Pack	$H_0 = 18.5 \pm 0.5$	R
27.5	<b>Standard Lead and Packaging Options</b>		
	Pizza – Long Leads	17 +0/-1	ZLH0J
	Pizza Pack	4 +2/-0	Z
37.5	<b>Standard Lead and Packaging Options</b>		
	Pizza – Long Leads	17 +0/-1	ZLH0J
	Pizza Pack	4 +2/-0	Z

## Dimensions – Millimeters

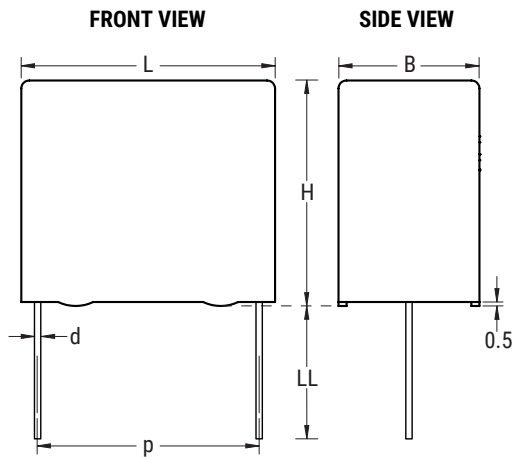

Size Code	p		B		H		L		d	
	Nominal	Tolerance	Nominal	Tolerance	Nominal	Tolerance	Nominal	Tolerance	Nominal	Tolerance
JF	5.0	+/-0.4	2.5	Maximum	6.5	Maximum	7.2	Maximum	0.5	+/-0.05
JG	5.0	+/-0.4	3.5	Maximum	7.5	Maximum	7.2	Maximum	0.5	+/-0.05
JM	5.0	+/-0.4	4.5	Maximum	9.5	Maximum	7.2	Maximum	0.5	+/-0.05
JQ	5.0	+/-0.4	5.0	Maximum	10.0	Maximum	7.2	Maximum	0.5	+/-0.05
JT	5.0	+/-0.4	6.0	Maximum	11.0	Maximum	7.2	Maximum	0.5	+/-0.05
JU	5.0	+/-0.4	7.2	Maximum	13.0	Maximum	7.2	Maximum	0.5	+/-0.05
KE	7.5	+/-0.4	2.5	Maximum	6.0	Maximum	10.0	Maximum	0.6	+/-0.05
KF	7.5	+/-0.4	3.0	Maximum	8.0	Maximum	10.0	Maximum	0.6	+/-0.05
KG	7.5	+/-0.4	4.0	Maximum	8.0	Maximum	10.0	Maximum	0.6	+/-0.05
KH	7.5	+/-0.4	4.0	Maximum	9.0	Maximum	10.0	Maximum	0.6	+/-0.05
KJ	7.5	+/-0.4	5.0	Maximum	10.5	Maximum	10.0	Maximum	0.6	+/-0.05
KM	7.5	+/-0.4	6.0	Maximum	12.0	Maximum	10.5	Maximum	0.6	+/-0.05
AG	10.0	+/-0.4	4.0	Maximum	9.0	Maximum	13.0	Maximum	0.6	+/-0.05
AK	10.0	+/-0.4	5.0	Maximum	11.0	Maximum	13.0	Maximum	0.6	+/-0.05
AP	10.0	+/-0.4	6.0	Maximum	12.0	Maximum	13.0	Maximum	0.6	+/-0.05
BB	15.0	+/-0.4	4.0	Maximum	10.0	Maximum	18.0	Maximum	0.8	+/-0.05
BC	15.0	+/-0.4	5.0	Maximum	11.0	Maximum	18.0	Maximum	0.8	+/-0.05
BE	15.0	+/-0.4	5.5	Maximum	12.5	Maximum	18.0	Maximum	0.8	+/-0.05
BG	15.0	+/-0.4	6.0	Maximum	12.0	Maximum	18.0	Maximum	0.8	+/-0.05
BK	15.0	+/-0.4	7.5	Maximum	13.5	Maximum	18.0	Maximum	0.8	+/-0.05
BP	15.0	+/-0.4	8.5	Maximum	14.5	Maximum	18.0	Maximum	0.8	+/-0.05
BS	15.0	+/-0.4	10.0	Maximum	16.0	Maximum	18.0	Maximum	0.8	+/-0.05
BY	15.0	+/-0.4	11.0	Maximum	19.0	Maximum	18.0	Maximum	0.8	+/-0.05
DB	22.5	+/-0.4	6.0	Maximum	14.5	Maximum	26.0	Maximum	0.8	+/-0.05
DI	22.5	+/-0.4	7.0	Maximum	16.0	Maximum	26.0	Maximum	0.8	+/-0.05
DH	22.5	+/-0.4	8.0	Maximum	16.0	Maximum	26.0	Maximum	0.8	+/-0.05
DJ	22.5	+/-0.4	8.5	Maximum	17.0	Maximum	26.0	Maximum	0.8	+/-0.05
DM	22.5	+/-0.4	9.0	Maximum	18.5	Maximum	26.0	Maximum	0.8	+/-0.05
DO	22.5	+/-0.4	10.0	Maximum	18.5	Maximum	26.0	Maximum	0.8	+/-0.05

Note: See Ordering Options Table for lead length (LL) options.

## Dimensions – Millimeters cont'd

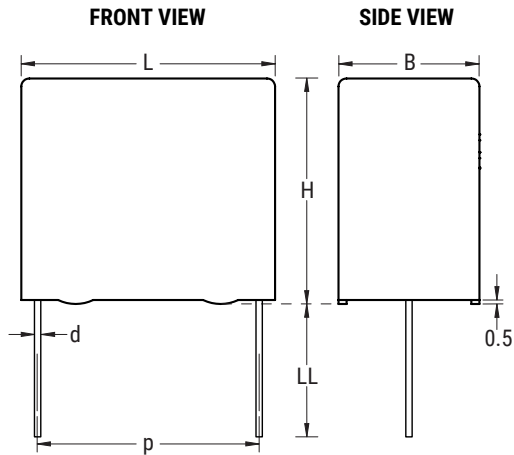

Size Code	p		B		H		L		d	
	Nominal	Tolerance	Nominal	Tolerance	Nominal	Tolerance	Nominal	Tolerance	Nominal	Tolerance
DP	22.5	+/-0.4	11.0	Maximum	20.0	Maximum	26.0	Maximum	0.8	+/-0.05
DU	22.5	+/-0.4	13.0	Maximum	22.0	Maximum	26.0	Maximum	0.8	+/-0.05
DY	22.5	+/-0.4	15.5	Maximum	24.5	Maximum	26.0	Maximum	0.8	+/-0.05
FB	27.5	+/-0.4	9.0	Maximum	17.0	Maximum	31.5	Maximum	0.8	+/-0.05
FC	27.5	+/-0.4	11.0	Maximum	20.0	Maximum	31.5	Maximum	0.8	+/-0.05
FI	27.5	+/-0.4	13.0	Maximum	25.0	Maximum	31.5	Maximum	0.8	+/-0.05
FN	27.5	+/-0.4	14.0	Maximum	28.0	Maximum	31.5	Maximum	0.8	+/-0.05
FR	27.5	+/-0.4	17.5	Maximum	28.0	Maximum	31.5	Maximum	0.8	+/-0.05
FS	27.5	+/-0.4	19.0	Maximum	29.0	Maximum	31.5	Maximum	0.8	+/-0.05
FY	27.5	+/-0.4	22.0	Maximum	37.0	Maximum	31.5	Maximum	0.8	+/-0.05
RB	37.5	+/-0.4	11.0	Maximum	22.0	Maximum	41.0	Maximum	1	+/-0.05
RF	37.5	+/-0.4	13.0	Maximum	24.0	Maximum	41.0	Maximum	1	+/-0.05
RH	37.5	+/-0.4	15.0	Maximum	26.0	Maximum	41.0	Maximum	1	+/-0.05
RC	37.5	+/-0.4	16.0	Maximum	28.5	Maximum	41.0	Maximum	1	+/-0.05
RD	37.5	+/-0.4	19.0	Maximum	32.0	Maximum	41.0	Maximum	1	+/-0.05
RP	37.5	+/-0.4	21.0	Maximum	38.0	Maximum	41.0	Maximum	1	+/-0.05
RO	37.5	+/-0.4	24.0	Maximum	44.0	Maximum	41.0	Maximum	1	+/-0.05
RU	37.5	+/-0.4	30.0	Maximum	45.0	Maximum	41.0	Maximum	1	+/-0.05

**Note: See Ordering Options Table for lead length (LL) options.**

## Performance Characteristics

Voltage Range $V_R$ (VDC)	50	63	100	160	250	400	630	1,000
Voltage Range $V_R$ (VAC)	30	40	63	90	160/140	200/160	220	250
Capacitance Range ( $\mu\text{F}$ )	0.27 – 15	0.1 – 180	0.001 – 180	0.18 – 120	0.0068 – 82	0.001 – 33	0.0012 – 12	0.001 – 5.6
Capacitance Tolerance	$\pm 10\%$ , $\pm 20\%$ , $\pm 5\%$ on request							
Category Temperature Range	-55°C to +105°C							
Voltage Derating	Above +85°C DC and AC voltage derating is 1.25%/°C							
Rated Temperature	+85°C							
Climatic Category	IEC60068-1, 55/105/56							
	-55 to +105°C (For +125°C, please consult KEMET)							
	Average relative humidity $\leq 75\%$							
	RH = 95% for 30 days per year							
	RH = 85% for further days limited by average value per year							
Test Voltage	$1.6 \times V_R$ VDC for 2 seconds							
Capacitance Drift	Maximum 2% after a 2 year storage period at a temperature of +10°C to +40°C and a relative humidity of 40% to 60%							
Reliability	Operational life > 200,000 hours							
	Failure rate < 3 FIT, T = +40°C, V = $0.5 \times V_R$							
	Failure criteria: open circuit, short circuit, cap change > 10%, DF 2 times the catalog limits, IR < 50 M $\Omega$							
Maximum Pulse Steepness	dV/dt according to Table 1. For peak to peak voltages lower than rated voltage ( $V_{pp} < V_R$ ), the specified dV/dt can be multiplied by the factor $V_R/V_{pp}$ .							
Temperature Coefficient	+400 ( $\pm 200$ ) ppm/°C at 1 kHz							
Self Inductance	Approximately 6 nH/cm for the total length of capacitor winding and the leads							
Dissipation Factor $\tan\delta$	Maximum Values at +23°C							
			$C \leq 0.1 \mu\text{F}$	$0.1 \mu\text{F} < C \leq 1.0 \mu\text{F}$	$C > 1.0 \mu\text{F}$			
Lead Spacing 5 mm	1 kHz		0.8%	0.8%	0.8%			
	10 kHz		1.2%	1.2%	1.5%			
	100 kHz		2.5%					
Lead Spacing 7.5 – 37.5 mm	1 kHz		0.8%	0.8%	1.2%			
	10 kHz		1.5%	1.5%				
	100 kHz		3.0%					
Insulation Resistance	Measured at +20°C, according to IEC 60384-2							
	Minimum Values Between Terminals							
			$C \leq 0.33 \mu\text{F}$	$C > 0.33 \mu\text{F}$				
	$V_R \leq 100$ VDC		15,000 M $\Omega$	5,000 M $\Omega \cdot \mu\text{F}$				
	$V_R > 100$ VDC		30,000 M $\Omega$	10,000 M $\Omega \cdot \mu\text{F}$				

## Maximum Voltage ( $V_{rms}$ ) vs. Frequency (Sinusoidal Waveform/ $T \leq 40^\circ\text{C}$ )

Lead Spacing 5 mm

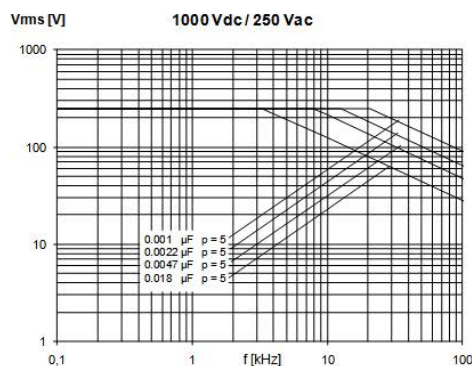
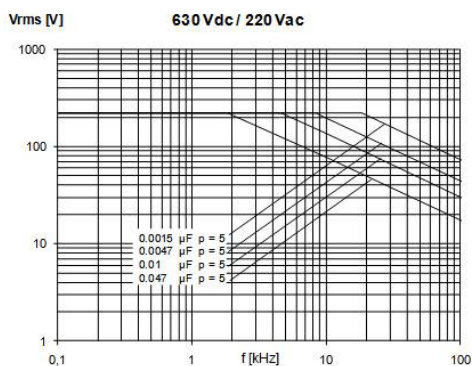
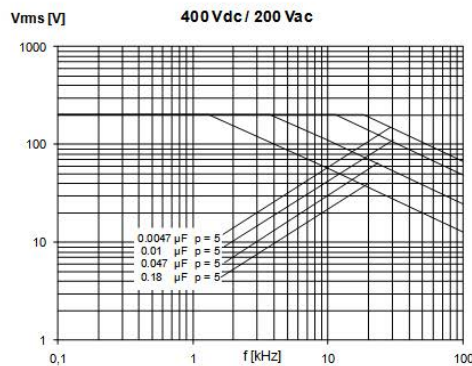
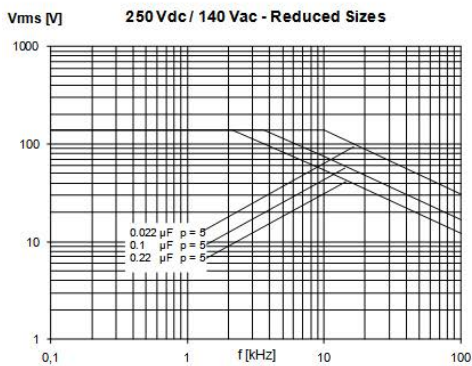
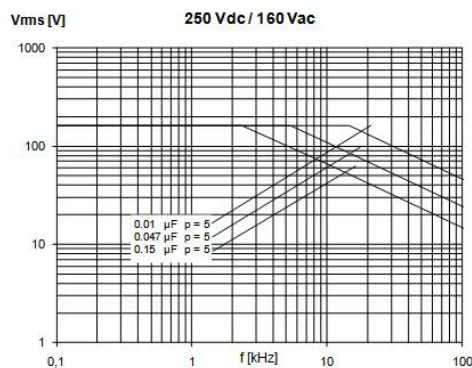
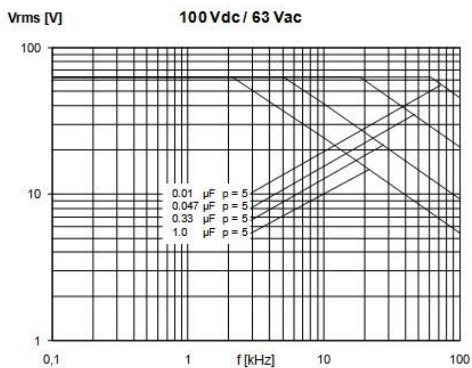
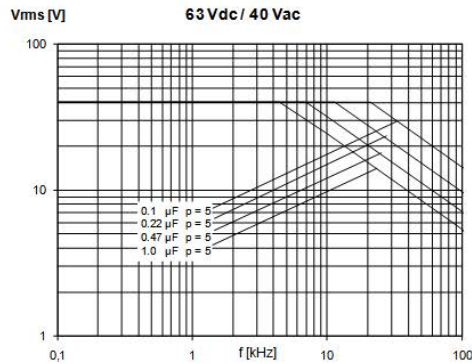
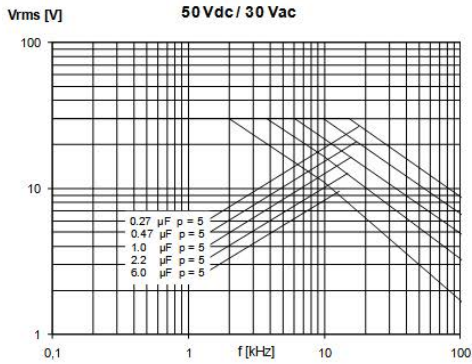

## Maximum Voltage ( $V_{rms}$ ) vs. Frequency (Sinusoidal Waveform/ $T \leq 40^\circ\text{C}$ )

Lead Spacing 7.5 mm

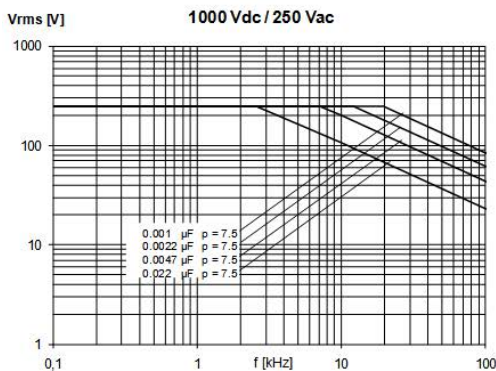
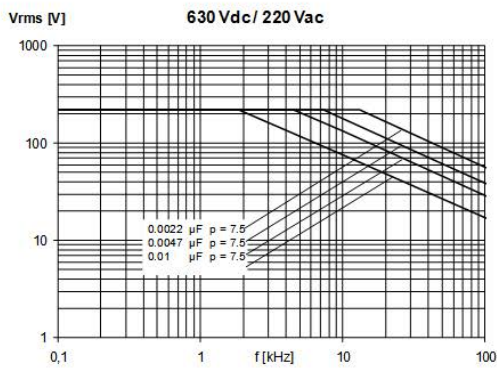
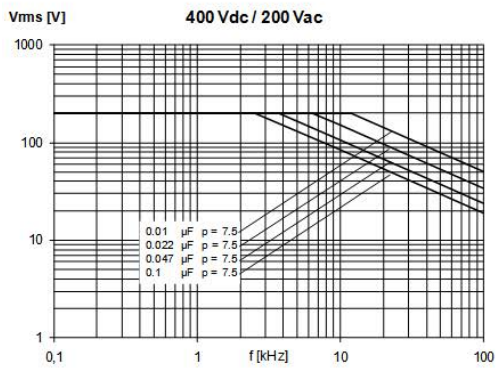
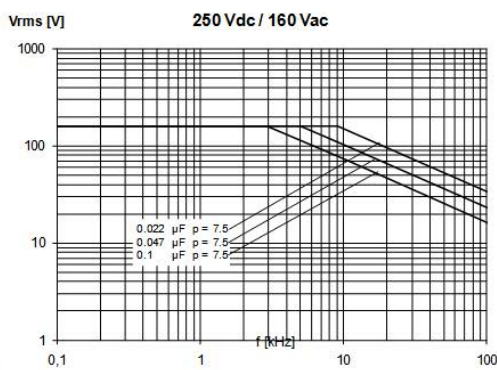
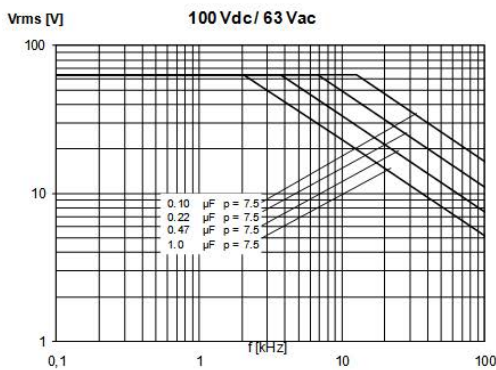
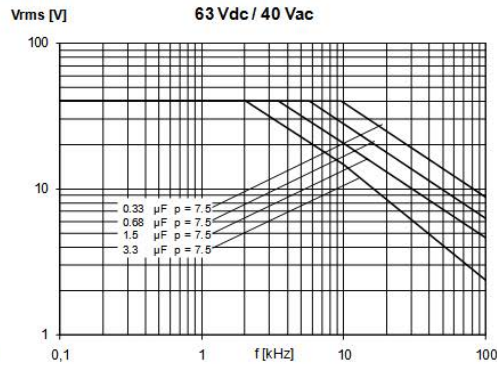
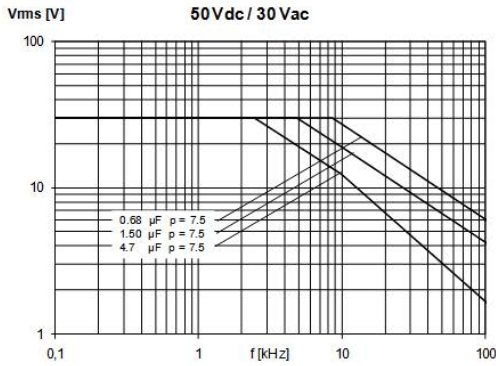



## Maximum Voltage ( $V_{rms}$ ) vs. Frequency (Sinusoidal Waveform/ $T \leq 40^\circ C$ )

Lead Spacing 10 – 37.5 mm

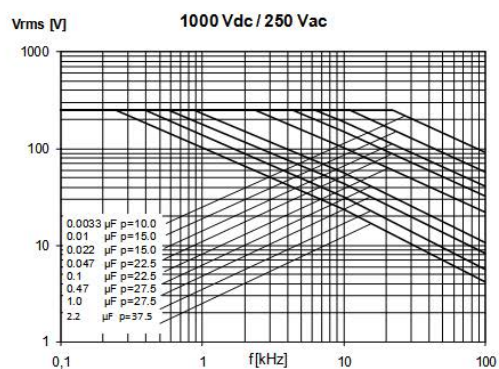
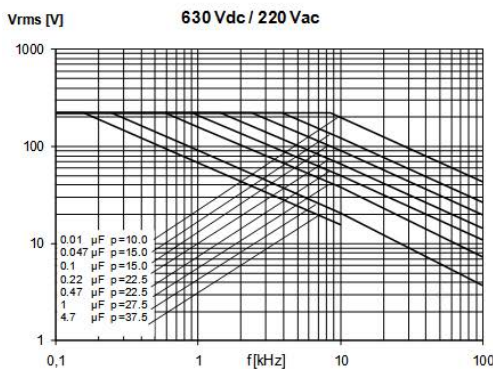
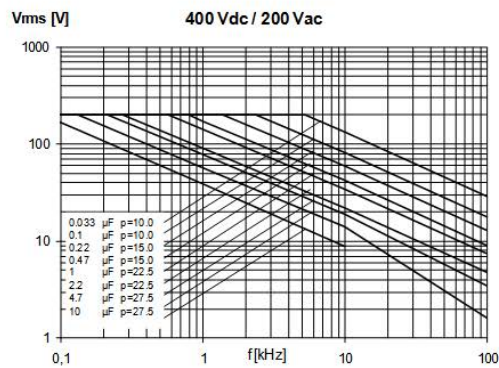
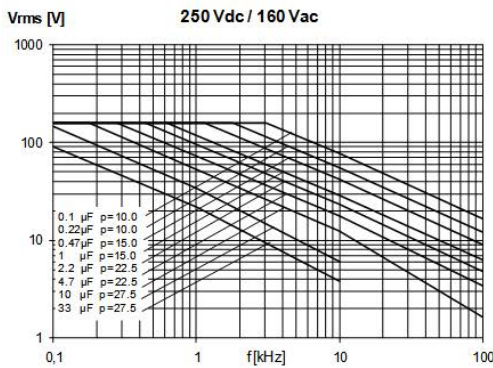
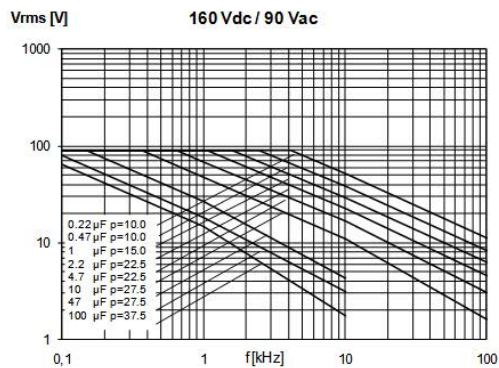
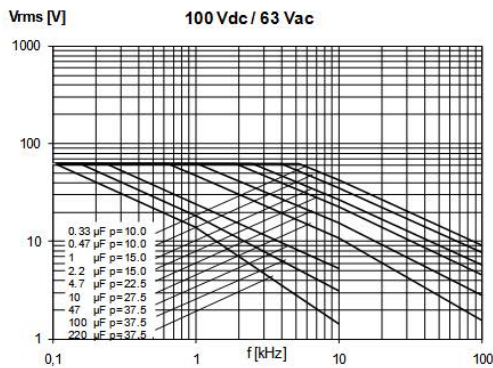
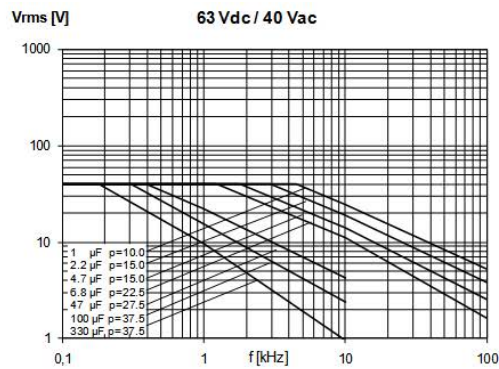
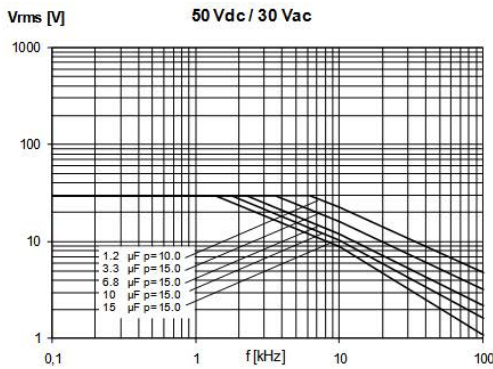

## Maximum Current ( $I_{rms}$ ) vs. Frequency (Sinusoidal Waveform/ $T \leq 40^\circ\text{C}$ )

Lead Spacing 5 mm

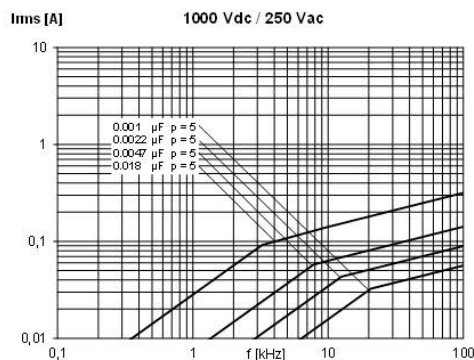
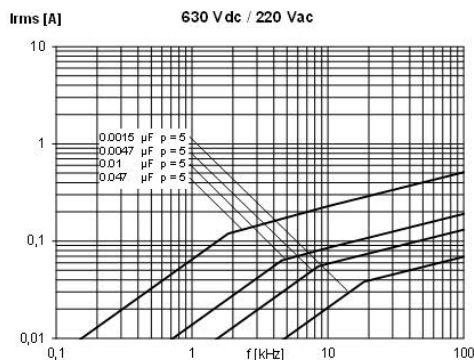
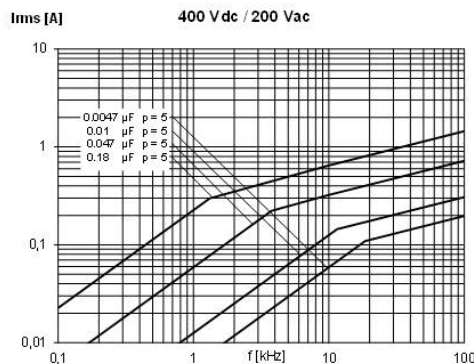
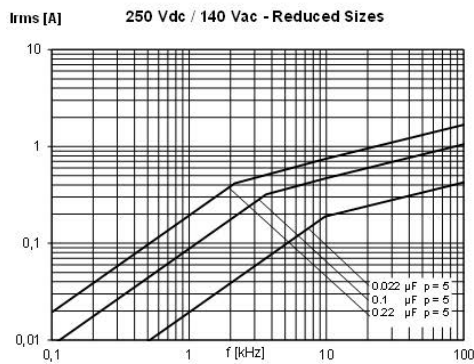
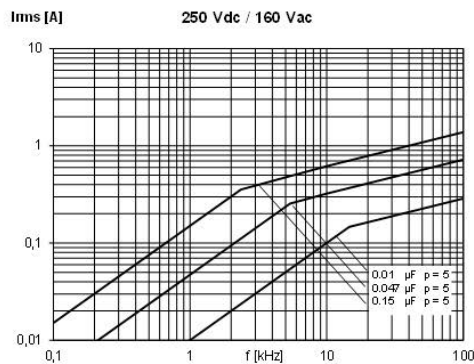
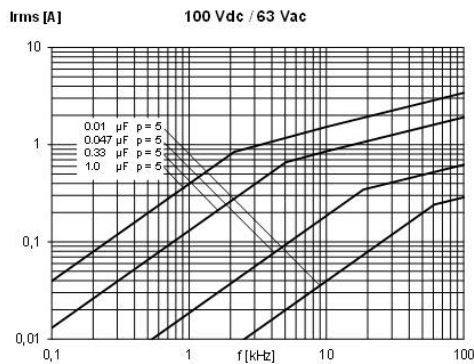
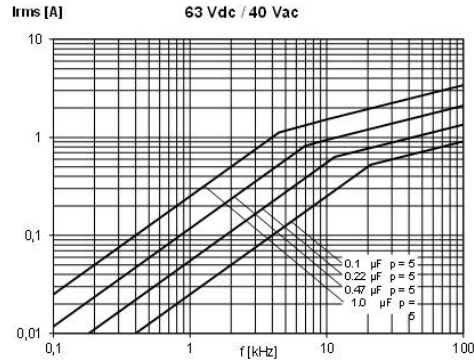
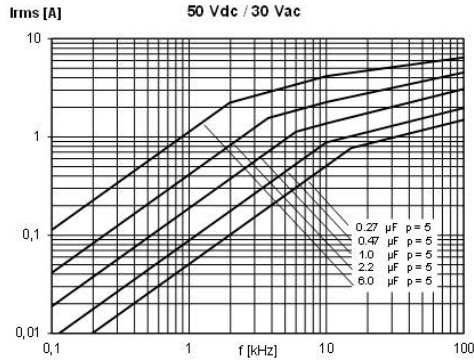

## Maximum Current ( $I_{rms}$ ) vs. Frequency (Sinusoidal Waveform/ $T \leq 40^\circ\text{C}$ )

Lead Spacing 7.5 mm

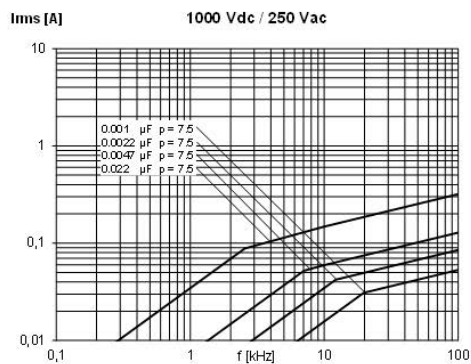
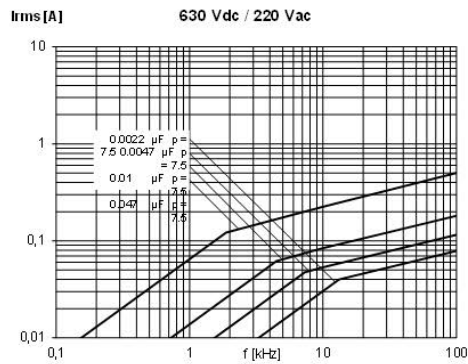
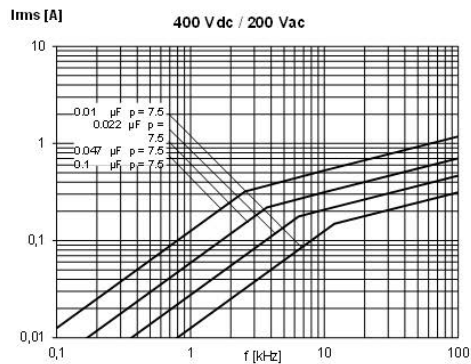
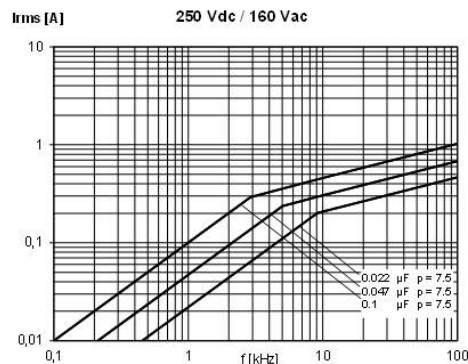
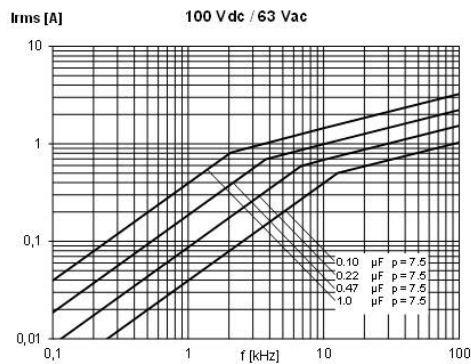
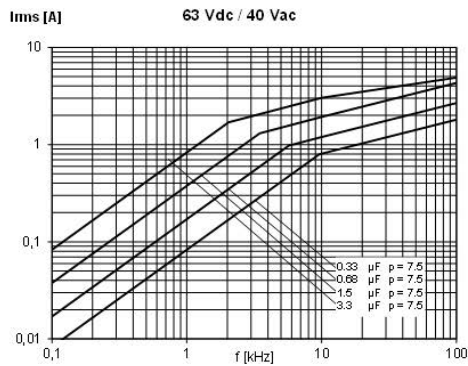
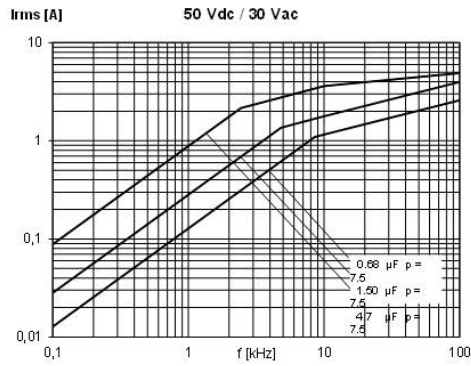

## Maximum Current ( $I_{rms}$ ) vs. Frequency (Sinusoidal Waveform/ $T \leq 40^\circ\text{C}$ )

Lead Spacing 10 – 37.5 mm

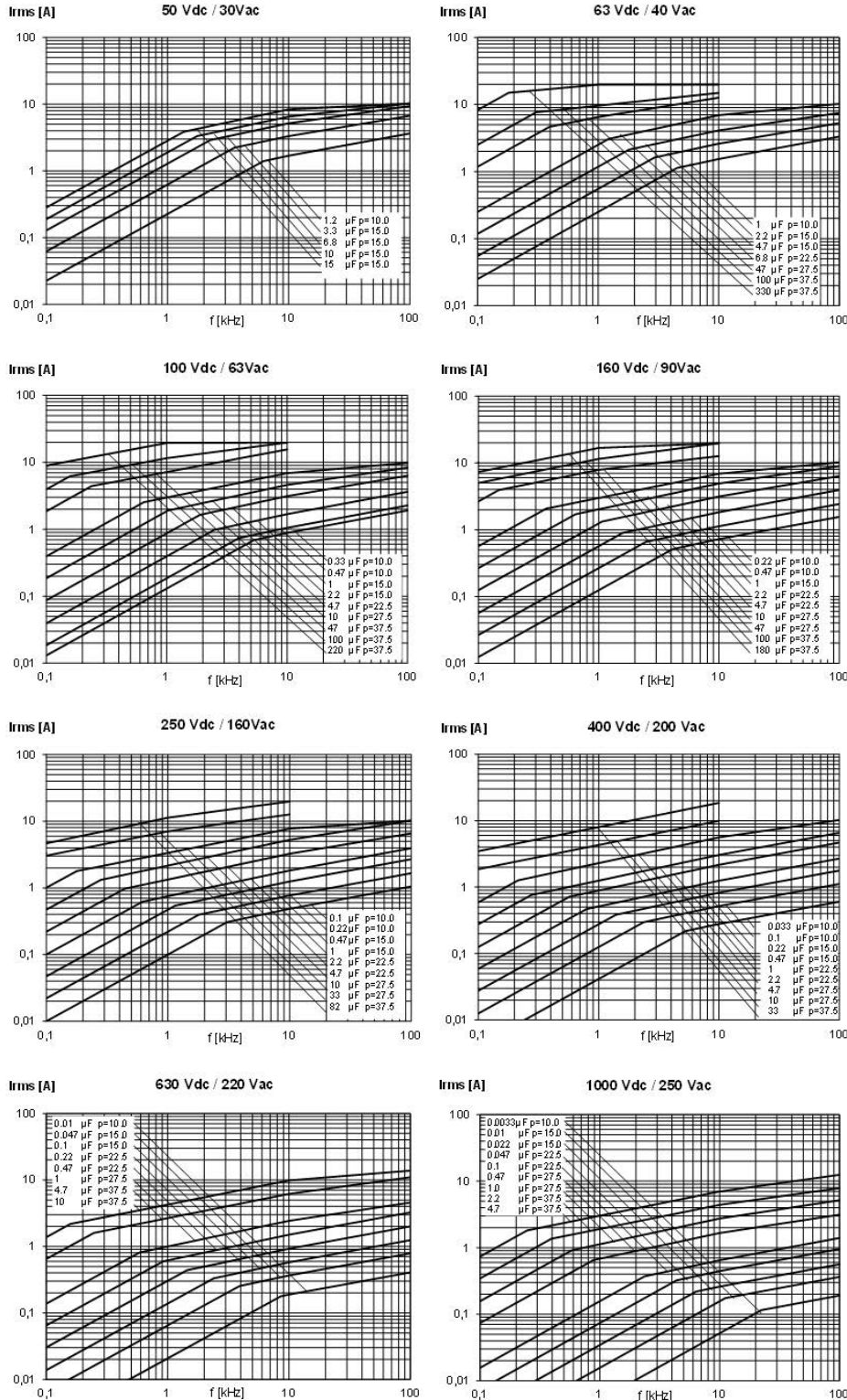

## Environmental Test Data

Damp Heat Test	Test Conditions	T = +40°C, RH = 93%, t = 56 days
	Test Criteria	$\Delta C/C \leq \pm 5\%$ $\Delta \tan\delta \leq 0.005$ (1 kHz) IR after test 0.5 x IR minimum
Endurance Test	Test Conditions	T = +100°C, U = 1.25 x (0.8 x U <sub>R</sub> )
	Test Criteria	t = 2,000 hours $\Delta C/C \leq \pm 5\%$ , $\Delta \tan\delta \leq 0.005$ (1 kHz) $\Delta \tan\delta \leq 0.010$ (100 kHz) IR after test 0.5 x IR minimum

## Environmental Compliance

All KEMET MKT capacitors are RoHS Compliant and Halogen Free.



**Table 1 – Ratings & Part Number Reference**

VDC	VAC	Capacitance Value (µF)	Size Code	Maximum Dimensions in mm			Lead Spacing (p)	dV/dt (V/µs)	Part Number
				B	H	L			
50	30	0.27	JF	2.5	6.5	7.2	5.0	12	F611JF274(1)050(4)
50	30	0.33	JF	2.5	6.5	7.2	5.0	12	F611JF334(1)050(4)
50	30	0.39	JF	2.5	6.5	7.2	5.0	12	F611JF394(1)050(4)
50	30	0.47	JF	2.5	6.5	7.2	5.0	12	F611JF474(1)050(4)
50	30	0.56	JG	3.5	7.5	7.2	5.0	12	F611JG564(1)050(4)
50	30	0.68	JG	3.5	7.5	7.2	5.0	12	F611JG684(1)050(4)
50	30	0.82	JG	3.5	7.5	7.2	5.0	12	F611JG824(1)050(4)
50	30	1	JG	3.5	7.5	7.2	5.0	12	F611JG105(1)050(4)
50	30	1.2	JM	4.5	9.5	7.2	5.0	12	F611JM125(1)050(4)
50	30	1.5	JM	4.5	9.5	7.2	5.0	12	F611JM155(1)050(4)
50	30	1.8	JQ	5	10	7.2	5.0	12	F611JQ185(1)050(4)
50	30	2.2	JQ	5	10	7.2	5.0	12	F611JQ225(1)050(4)
50	30	2.7	JT	6	11	7.2	5.0	12	F611JT275(1)050(4)
50	30	3.3	JT	6	11	7.2	5.0	12	F611JT335(1)050(4)
50	30	3.9	JU	7.2	13	7.2	5.0	12	F611JU395(1)050(4)
50	30	4.7	JU	7.2	13	7.2	5.0	12	F611JU475(1)050(4)
50	30	5.6	JU	7.2	13	7.2	5.0	12	F611JU565(1)050(4)
50	30	6	JU	7.2	13	7.2	5.0	12	F611JU605(1)050(4)
50	30	1.8	BB	4	10	18	15.0	3	F611BB185(1)050(4)
50	30	2.2	BC	5	11	18	15.0	3	F611BC225(1)050(4)
50	30	2.7	BC	5	11	18	15.0	3	F611BC275(1)050(4)
50	30	3.3	BE	5.5	12.5	18	15.0	3	F611BE335(1)050(4)
50	30	3.9	BE	5.5	12.5	18	15.0	3	F611BE395(1)050(4)
50	30	4.7	BK	7.5	13.5	18	15.0	3	F611BK475(1)050(4)
50	30	5.6	BK	7.5	13.5	18	15.0	3	F611BK565(1)050(4)
50	30	6.8	BP	8.5	14.5	18	15.0	3	F611BP685(1)050(4)
50	30	8.2	BP	8.5	14.5	18	15.0	3	F611BP825(1)050(4)
50	30	10	BS	10	16	18	15.0	3	F611BS106(1)050(4)
50	30	12	BY	11	19	18	15.0	3	F611BY126(1)050(4)
50	30	15	BY	11	19	18	15.0	3	F611BY156(1)050(4)
63	40	0.1	JF	2.5	6.5	7.2	5.0	160	F612JF104(1)063(4)
63	40	0.12	JF	2.5	6.5	7.2	5.0	160	F612JF124(1)063(4)
63	40	0.15	JF	2.5	6.5	7.2	5.0	160	F612JF154(1)063(4)
63	40	0.18	JF	2.5	6.5	7.2	5.0	160	F612JF184(1)063(4)
63	40	0.22	JF	2.5	6.5	7.2	5.0	160	F612JF224(1)063(4)
63	40	0.27	JG	3.5	7.5	7.2	5.0	160	F612JG274(1)063(4)
63	40	0.33	JG	3.5	7.5	7.2	5.0	160	F612JG334(1)063(4)
63	40	0.39	JG	3.5	7.5	7.2	5.0	160	F612JG394(1)063(4)
63	40	0.47	JG	3.5	7.5	7.2	5.0	160	F612JG474(1)063(4)
63	40	0.56	JM	4.5	9.5	7.2	5.0	160	F612JM564(1)063(4)
63	40	0.68	JM	4.5	9.5	7.2	5.0	160	F612JM684(1)063(4)
63	40	0.82	JM	4.5	9.5	7.2	5.0	160	F612JM824(1)063(4)
63	40	1	JQ	5	10	7.2	5.0	160	F612JQ105(1)063(4)
63	40	1.2	JT	6	11	7.2	5.0	160	F612JT125(1)063(4)
63	40	1.5	JT	6	11	7.2	5.0	160	F612JT155(1)063(4)
63	40	1.2	BB	4	10	18	15.0	5	F611BB125(1)063(4)
63	40	1.5	BB	4	10	18	15.0	5	F611BB155(1)063(4)
63	40	1.8	BC	5	11	18	15.0	5	F611BC185(1)063(4)
63	40	2.2	BE	5.5	12.5	18	15.0	5	F611BE225(1)063(4)
63	40	2.7	BE	5.5	12.5	18	15.0	5	F611BE275(1)063(4)
63	40	3.3	BG	6	12	18	15.0	5	F611BG335(1)063(4)
63	40	3.9	BK	7.5	13.5	18	15.0	5	F611BK395(1)063(4)
63	40	4.7	BK	7.5	13.5	18	15.0	5	F611BK475(1)063(4)
63	40	5.6	BP	8.5	14.5	18	15.0	5	F611BP565(1)063(4)
63	40	6.8	BP	8.5	14.5	18	15.0	5	F611BP685(1)063(4)
63	40	8.2	BS	10	16	18	15.0	5	F611BS825(1)063(4)
63	40	10	BS	10	16	18	15.0	5	F611BS106(1)063(4)
VDC	VAC	Capacitance Value (µF)	Size Code	B (mm)	H (mm)	L (mm)	Lead Spacing (p)	dV/dt (V/µs)	Part Number

(1) K= ±10%, M = ±20%; J = ±5% on request

(2) K= ±10%, M = ±20%; J = ±5% not available

(3) M = ±20% (only available tolerance).

(4) Insert lead and packaging code. See Ordering Options Table for available options.

**Table 1 – Ratings & Part Number Reference cont'd**

VDC	VAC	Capacitance Value (µF)	Size Code	Maximum Dimensions in mm			Lead Spacing (p)	dV/dt (V/µs)	Part Number
				B	H	L			
63	40	12	BY	11	19	18	15.0	5	F611BY126(1)063(4)
63	40	4.7	DB	6	14.5	26	22.5	3	F611DB475(1)063(4)
63	40	5.6	DB	6	14.5	26	22.5	3	F611DB565(1)063(4)
63	40	6.8	DI	7	16	26	22.5	3	F611DI685(1)063(4)
63	40	8.2	DI	7	16	26	22.5	3	F611DI825(1)063(4)
63	40	10	DJ	8.5	17	26	22.5	3	F611DJ106(1)063(4)
63	40	12	DM	9	18.5	26	22.5	3	F611DM126(1)063(4)
63	40	15	DO	10	18.5	26	22.5	3	F611DO156(1)063(4)
63	40	18	DP	11	20	26	22.5	3	F611DP186(1)063(4)
63	40	22	DU	13	22	26	22.5	3	F611DU226(1)063(4)
63	40	27	DY	15.5	24.5	26	22.5	3	F611DY276(1)063(4)
63	40	33	DY	15.5	24.5	26	22.5	3	F611DY336(1)063(4)
63	40	15	FB	9	17	31.5	27.5	2	F611FB156(3)063(4)
63	40	18	FC	11	20	31.5	27.5	2	F611FC186(1)063(4)
63	40	22	FC	11	20	31.5	27.5	2	F611FC226(3)063(4)
63	40	27	FI	13	25	31.5	27.5	2	F611FI276(1)063(4)
63	40	33	FI	13	25	31.5	27.5	2	F611FI336(3)063(4)
63	40	39	FN	14	28	31.5	27.5	2	F611FN396(2)063(4)
63	40	47	FR	17.5	28	31.5	27.5	2	F611FR476(2)063(4)
63	40	56	FS	19	29	31.5	27.5	2	F611FS566(2)063(4)
63	40	68	FY	22	37	31.5	27.5	2	F611FY686(1)063(4)
63	40	82	FY	22	37	31.5	27.5	2	F611FY826(1)063(4)
63	40	100	FY	22	37	31.5	27.5	2	F611FY107(3)063(4)
63	40	22	RB	11	22	41	37.5	1	F611RB226(1)063(4)
63	40	27	RB	11	22	41	37.5	1	F611RB276(2)063(4)
63	40	33	RF	13	24	41	37.5	1	F611RF336(1)063(4)
63	40	39	RH	15	26	41	37.5	1	F611RH396(1)063(4)
63	40	47	RH	15	26	41	37.5	1	F611RH476(2)063(4)
63	40	56	RC	16	28.5	41	37.5	1	F611RC566(2)063(4)
63	40	68	RD	19	32	41	37.5	1	F611RD686(1)063(4)
63	40	82	RP	21	38	41	37.5	1	F611RP826(1)063(4)
63	40	100	RP	21	38	41	37.5	1	F611RP107(2)063(4)
63	40	120	RO	24	44	41	37.5	1	F611RO127(1)063(4)
63	40	150	RO	24	44	41	37.5	1	F611RO157(2)063(4)
63	40	180	RU	30	45	41	37.5	1	F611RU187(2)063(4)
100	63	0.001	JF	2.5	6.5	7.2	5.0	200	F612JF102(1)100(4)
100	63	0.0012	JF	2.5	6.5	7.2	5.0	200	F612JF122(1)100(4)
100	63	0.0015	JF	2.5	6.5	7.2	5.0	200	F612JF152(1)100(4)
100	63	0.0018	JF	2.5	6.5	7.2	5.0	200	F612JF182(1)100(4)
100	63	0.0022	JF	2.5	6.5	7.2	5.0	200	F612JF222(1)100(4)
100	63	0.0027	JF	2.5	6.5	7.2	5.0	200	F612JF272(1)100(4)
100	63	0.0033	JF	2.5	6.5	7.2	5.0	200	F612JF332(1)100(4)
100	63	0.0039	JF	2.5	6.5	7.2	5.0	200	F612JF392(1)100(4)
100	63	0.0047	JF	2.5	6.5	7.2	5.0	200	F612JF472(1)100(4)
100	63	0.0056	JF	2.5	6.5	7.2	5.0	200	F612JF562(1)100(4)
100	63	0.0068	JF	2.5	6.5	7.2	5.0	200	F612JF682(1)100(4)
100	63	0.0082	JF	2.5	6.5	7.2	5.0	200	F612JF822(1)100(4)
100	63	0.01	JF	2.5	6.5	7.2	5.0	200	F612JF103(1)100(4)
100	63	0.012	JF	2.5	6.5	7.2	5.0	200	F612JF123(1)100(4)
100	63	0.015	JF	2.5	6.5	7.2	5.0	200	F612JF153(1)100(4)
100	63	0.018	JF	2.5	6.5	7.2	5.0	200	F612JF183(1)100(4)
100	63	0.022	JF	2.5	6.5	7.2	5.0	200	F612JF223(1)100(4)
100	63	0.027	JF	2.5	6.5	7.2	5.0	200	F612JF273(1)100(4)
100	63	0.033	JF	2.5	6.5	7.2	5.0	200	F612JF333(1)100(4)
100	63	0.039	JF	2.5	6.5	7.2	5.0	200	F612JF393(1)100(4)
100	63	0.047	JF	2.5	6.5	7.2	5.0	200	F612JF473(1)100(4)
100	63	0.056	JF	2.5	6.5	7.2	5.0	200	F612JF563(1)100(4)
VDC	VAC	Capacitance Value (µF)	Size Code	B (mm)	H (mm)	L (mm)	Lead Spacing (p)	dV/dt (V/µs)	Part Number

(1) K= ±10%, M = ±20%; J = ±5% on request

(2) K= ±10%, M = ±20%; J = ±5% not available

(3) M = ±20% (only available tolerance).

(4) Insert lead and packaging code. See Ordering Options Table for available options.

**Table 1 – Ratings & Part Number Reference cont'd**

VDC	VAC	Capacitance Value (µF)	Size Code	Maximum Dimensions in mm			Lead Spacing (p)	dV/dt (V/µs)	Part Number
				B	H	L			
100	63	0.068	JF	2.5	6.5	7.2	5.0	200	F612JF683(1)100(4)
100	63	0.082	JF	2.5	6.5	7.2	5.0	200	F612JF823(1)100(4)
100	63	0.1	JF	2.5	6.5	7.2	5.0	200	F612JF104(1)100(4)
100	63	0.12	JF	2.5	6.5	7.2	5.0	200	F612JF124(1)100(4)
100	63	0.15	JG	3.5	7.5	7.2	5.0	200	F612JG154(1)100(4)
100	63	0.18	JG	3.5	7.5	7.2	5.0	200	F612JG184(1)100(4)
100	63	0.22	JG	3.5	7.5	7.2	5.0	200	F612JG224(1)100(4)
100	63	0.27	JG	3.5	7.5	7.2	5.0	200	F612JG274(1)100(4)
100	63	0.33	JM	4.5	9.5	7.2	5.0	200	F612JM334(1)100(4)
100	63	0.39	JM	4.5	9.5	7.2	5.0	200	F612JM394(1)100(4)
100	63	0.47	JM	4.5	9.5	7.2	5.0	200	F612JM474(1)100(4)
100	63	0.56	JQ	5	10	7.2	5.0	200	F612JQ564(1)100(4)
100	63	0.68	JQ	5	10	7.2	5.0	200	F612JQ684(1)100(4)
100	63	0.82	JT	6	11	7.2	5.0	200	F612JT824(1)100(4)
100	63	1	JT	6	11	7.2	5.0	200	F612JT105(1)100(4)
100	63	0.56	BB	4	10	18	15.0	8	F611BB564(1)100(4)
100	63	0.68	BB	4	10	18	15.0	8	F611BB684(1)100(4)
100	63	0.82	BB	4	10	18	15.0	8	F611BB824(1)100(4)
100	63	1	BB	4	10	18	15.0	8	F611BB105(1)100(4)
100	63	1.2	BC	5	11	18	15.0	8	F611BC125(1)100(4)
100	63	1.5	BC	5	11	18	15.0	8	F611BC155(1)100(4)
100	63	1.8	BE	5.5	12.5	18	15.0	8	F611BE185(1)100(4)
100	63	2.2	BG	6	12	18	15.0	8	F611BG225(1)100(4)
100	63	2.7	BK	7.5	13.5	18	15.0	8	F611BK275(1)100(4)
100	63	3.3	BK	7.5	13.5	18	15.0	8	F611BK335(1)100(4)
100	63	3.9	BP	8.5	14.5	18	15.0	8	F611BP395(1)100(4)
100	63	4.7	BP	8.5	14.5	18	15.0	8	F611BP475(1)100(4)
100	63	5.6	BS	10	16	18	15.0	8	F611BS565(1)100(4)
100	63	6.8	BY	11	19	18	15.0	8	F611BY685(1)100(4)
100	63	8.2	BY	11	19	18	15.0	8	F611BY825(1)100(4)
100	63	2.2	DB	6	14.5	26	22.5	5	F611DB225(1)100(4)
100	63	2.7	DB	6	14.5	26	22.5	5	F611DB275(1)100(4)
100	63	3.3	DB	6	14.5	26	22.5	5	F611DB335(1)100(4)
100	63	3.9	DB	6	14.5	26	22.5	5	F611DB395(1)100(4)
100	63	4.7	DI	7	16	26	22.5	5	F611DI475(1)100(4)
100	63	5.6	DI	7	16	26	22.5	5	F611DI565(1)100(4)
100	63	6.8	DH	8	16	26	22.5	5	F611DH685(1)100(4)
100	63	8.2	DJ	8.5	17	26	22.5	5	F611DJ825(1)100(4)
100	63	10	DM	9	18.5	26	22.5	5	F611DM106(1)100(4)
100	63	12	DO	10	18.5	26	22.5	5	F611DO126(1)100(4)
100	63	15	DP	11	20	26	22.5	5	F611DP156(1)100(4)
100	63	18	DU	13	22	26	22.5	5	F611DU186(1)100(4)
100	63	22	DY	15.5	24.5	26	22.5	5	F611DY226(1)100(4)
100	63	27	DY	15.5	24.5	26	22.5	5	F611DY276(1)100(4)
100	63	10	FB	9	17	31.5	27.5	3	F611FB106(1)100(4)
100	63	12	FB	9	17	31.5	27.5	3	F611FB126(2)100(4)
100	63	15	FC	11	20	31.5	27.5	3	F611FC156(1)100(4)
100	63	18	FC	11	20	31.5	27.5	3	F611FC186(2)100(4)
100	63	22	FI	13	25	31.5	27.5	3	F611FI226(1)100(4)
100	63	27	FI	13	25	31.5	27.5	3	F611FI276(2)100(4)
100	63	33	FN	14	28	31.5	27.5	3	F611FN336(2)100(4)
100	63	39	FR	17.5	28	31.5	27.5	3	F611FR396(2)100(4)
100	63	47	FS	19	29	31.5	27.5	3	F611FS476(2)100(4)
100	63	56	FY	22	37	31.5	27.5	3	F611FY566(1)100(4)
100	63	68	FY	22	37	31.5	27.5	3	F611FY686(1)100(4)
100	63	82	FY	22	37	31.5	27.5	3	F611FY826(3)100(4)
100	63	22	RB	11	22	41	37.5	2	F611RB226(1)100(4)

(1) K= ±10%, M = ±20%; J = ±5% on request

(2) K= ±10%, M = ±20%; J = ±5% not available

(3) M = ±20% (only available tolerance).

(4) Insert lead and packaging code. See Ordering Options Table for available options.



**Table 1 – Ratings & Part Number Reference cont'd**

VDC	VAC	Capacitance Value (µF)	Size Code	Maximum Dimensions in mm			Lead Spacing (p)	dV/dt (V/µs)	Part Number
				B	H	L			
100	63	27	RB	11	22	41	37.5	2	F611RB276(2)100(4)
100	63	33	RF	13	24	41	37.5	2	F611RF336(1)100(4)
100	63	39	RH	15	26	41	37.5	2	F611RH396(1)100(4)
100	63	47	RH	15	26	41	37.5	2	F611RH476(2)100(4)
100	63	56	RC	16	28.5	41	37.5	2	F611RC566(2)100(4)
100	63	68	RD	19	32	41	37.5	2	F611RD686(1)100(4)
100	63	82	RP	21	38	41	37.5	2	F611RP826(1)100(4)
100	63	100	RP	21	38	41	37.5	2	F611RP107(2)100(4)
100	63	120	RO	24	44	41	37.5	2	F611RO127(1)100(4)
100	63	150	RO	24	44	41	37.5	2	F611RO157(2)100(4)
100	63	180	RU	30	45	41	37.5	2	F611RU187(2)100(4)
160	90	0.33	BB	4	10	18	15.0	10	F611BB334(1)160(4)
160	90	0.39	BB	4	10	18	15.0	10	F611BB394(1)160(4)
160	90	0.47	BC	5	11	18	15.0	10	F611BC474(1)160(4)
160	90	0.56	BC	5	11	18	15.0	10	F611BC564(1)160(4)
160	90	0.68	BC	5	11	18	15.0	10	F611BC684(1)160(4)
160	90	0.82	BE	5.5	12.5	18	15.0	10	F611BE824(1)160(4)
160	90	1	BG	6	12	18	15.0	10	F611BG105(1)160(4)
160	90	1.2	BK	7.5	13.5	18	15.0	10	F611BK125(1)160(4)
160	90	1.5	BK	7.5	13.5	18	15.0	10	F611BK155(1)160(4)
160	90	1.8	BP	8.5	14.5	18	15.0	10	F611BP185(1)160(4)
160	90	2.2	BS	10	16	18	15.0	10	F611BS225(1)160(4)
160	90	2.7	BY	11	19	18	15.0	10	F611BY275(1)160(4)
160	90	3.3	BY	11	19	18	15.0	10	F611BY335(1)160(4)
160	90	3.9	BY	11	19	18	15.0	10	F611BY395(1)160(4)
160	90	1.2	DB	6	14.5	26	22.5	6	F611DB125(1)160(4)
160	90	1.5	DB	6	14.5	26	22.5	6	F611DB155(1)160(4)
160	90	1.8	DB	6	14.5	26	22.5	6	F611DB185(1)160(4)
160	90	2.2	DI	7	16	26	22.5	6	F611DI225(1)160(4)
160	90	2.7	DI	7	16	26	22.5	6	F611DI275(1)160(4)
160	90	3.3	DJ	8.5	17	26	22.5	6	F611DJ335(1)160(4)
160	90	3.9	DM	9	18.5	26	22.5	6	F611DM395(1)160(4)
160	90	4.7	DO	10	18.5	26	22.5	6	F611DO475(1)160(4)
160	90	5.6	DP	11	20	26	22.5	6	F611DP565(1)160(4)
160	90	6.8	DU	13	22	26	22.5	6	F611DU685(1)160(4)
160	90	8.2	DU	13	22	26	22.5	6	F611DU825(1)160(4)
160	90	10	DY	15.5	24.5	26	22.5	6	F611DY106(1)160(4)
160	90	12	DY	15.5	24.5	26	22.5	6	F611DY126(1)160(4)
160	90	5.6	FB	9	17	31.5	27.5	4	F611FB565(1)160(4)
160	90	6.8	FB	9	17	31.5	27.5	4	F611FB685(1)160(4)
160	90	8.2	FB	9	17	31.5	27.5	4	F611FB825(3)160(4)
160	90	10	FC	11	20	31.5	27.5	4	F611FC106(1)160(4)
160	90	12	FC	11	20	31.5	27.5	4	F611FC126(3)160(4)
160	90	15	FI	13	25	31.5	27.5	4	F611FI156(1)160(4)
160	90	18	FI	13	25	31.5	27.5	4	F611FI186(2)160(4)
160	90	22	FN	14	28	31.5	27.5	4	F611FN226(2)160(4)
160	90	27	FR	17.5	28	31.5	27.5	4	F611FR276(2)160(4)
160	90	33	FS	19	29	31.5	27.5	4	F611FS336(2)160(4)
160	90	39	FY	22	37	31.5	27.5	4	F611FY396(1)160(4)
160	90	47	FY	22	37	31.5	27.5	4	F611FY476(2)160(4)
160	90	56	FY	22	37	31.5	27.5	4	F611FY566(3)160(4)
160	90	15	RB	11	22	41	37.5	3	F611RB156(1)160(4)
160	90	18	RB	11	22	41	37.5	3	F611RB186(3)160(4)
160	90	22	RF	13	24	41	37.5	3	F611RF226(2)160(4)
160	90	27	RH	15	26	41	37.5	3	F611RH276(1)160(4)
160	90	33	RH	15	26	41	37.5	3	F611RH336(3)160(4)
160	90	39	RC	16	28.5	41	37.5	3	F611RC396(3)160(4)
VDC	VAC	Capacitance Value (µF)	Size Code	B (mm)	H (mm)	L (mm)	Lead Spacing (p)	dV/dt (V/µs)	Part Number

(1) K= ±10%, M = ±20%; J = ±5% on request

(2) K= ±10%, M = ±20%; J = ±5% not available

(3) M = ±20% (only available tolerance).

(4) Insert lead and packaging code. See Ordering Options Table for available options.

**Table 1 – Ratings & Part Number Reference cont'd**

VDC	VAC	Capacitance Value (µF)	Size Code	Maximum Dimensions in mm			Lead Spacing (p)	dV/dt (V/µs)	Part Number
				B	H	L			
160	90	47	RD	19	32	41	37.5	3	F611RD476(2)160(4)
160	90	56	RP	21	38	41	37.5	3	F611RP566(1)160(4)
160	90	68	RP	21	38	41	37.5	3	F611RP686(1)160(4)
160	90	82	RO	24	44	41	37.5	3	F611RO826(1)160(4)
160	90	100	RO	24	44	41	37.5	3	F611RO107(3)160(4)
160	90	120	RU	30	45	41	37.5	3	F611RU127(3)160(4)
250	160	0.0068	JF	2.5	6.5	7.2	5.0	250	F612JF682(1)250(4)
250	160	0.0082	JF	2.5	6.5	7.2	5.0	250	F612JF822(1)250(4)
250	160	0.01	JF	2.5	6.5	7.2	5.0	250	F612JF103(1)250(4)
250	160	0.012	JF	2.5	6.5	7.2	5.0	250	F612JF123(1)250(4)
250	160	0.015	JF	2.5	6.5	7.2	5.0	250	F612JF153(1)250(4)
250	160	0.018	JF	2.5	6.5	7.2	5.0	250	F612JF183(1)250(4)
250	160	0.022	JG	3.5	7.5	7.2	5.0	250	F612JG223(1)250(4)
250	160	0.027	JG	3.5	7.5	7.2	5.0	250	F612JG273(1)250(4)
250	160	0.033	JG	3.5	7.5	7.2	5.0	250	F612JG333(1)250(4)
250	160	0.039	JG	3.5	7.5	7.2	5.0	250	F612JG393(1)250(4)
250	160	0.047	JM	4.5	9.5	7.2	5.0	250	F612JM473(1)250(4)
250	160	0.056	JM	4.5	9.5	7.2	5.0	250	F612JM563(1)250(4)
250	160	0.068	JM	4.5	9.5	7.2	5.0	250	F612JM683(1)250(4)
250	160	0.082	JQ	5	10	7.2	5.0	250	F612JQ823(1)250(4)
250	160	0.1	JQ	5	10	7.2	5.0	250	F612JQ104(1)250(4)
250	160	0.12	JT	6	11	7.2	5.0	250	F612JT124(1)250(4)
250	160	0.15	JT	6	11	7.2	5.0	250	F612JT154(1)250(4)
250	140	0.022	JF	2.5	6.5	7.2	5.0	130	F612JF223(1)250(4)
250	140	0.027	JF	2.5	6.5	7.2	5.0	130	F612JF273(1)250(4)
250	140	0.047	JG	3.5	7.5	7.2	5.0	130	F612JG473(1)250(4)
250	140	0.056	JG	3.5	7.5	7.2	5.0	130	F612JG563(1)250(4)
250	140	0.068	JG	3.5	7.5	7.2	5.0	130	F612JG683(1)250(4)
250	140	0.082	JM	4.5	9.5	7.2	5.0	130	F612JM823(1)250(4)
250	140	0.1	JM	4.5	9.5	7.2	5.0	130	F612JM104(1)250(4)
250	140	0.12	JM	4.5	9.5	7.2	5.0	130	F612JM124(1)250(4)
250	140	0.15	JQ	5	10	7.2	5.0	130	F612JQ154(1)250(4)
250	140	0.18	JT	6	11	7.2	5.0	130	F612JT184(1)250(4)
250	140	0.22	JT	6	11	7.2	5.0	130	F612JT224(1)250(4)
250	160	0.1	AG	4	9	13	10.0	20	F611AG104(1)250(4)
250	160	0.12	AG	4	9	13	10.0	20	F611AG124(1)250(4)
250	160	0.15	AG	4	9	13	10.0	20	F611AG154(1)250(4)
250	160	0.18	AK	5	11	13	10.0	20	F611AK184(1)250(4)
250	160	0.22	AK	5	11	13	10.0	20	F611AK224(1)250(4)
250	160	0.27	AK	5	11	13	10.0	20	F611AK274(1)250(4)
250	160	0.33	AP	6	12	13	10.0	20	F611AP334(1)250(4)
250	160	0.39	AP	6	12	13	10.0	20	F611AP394(1)250(4)
250	160	0.47	AP	6	12	13	10.0	20	F611AP474(1)250(4)
250	160	0.18	BB	4	10	18	15.0	12	F611BB184(1)250(4)
250	160	0.22	BB	4	10	18	15.0	12	F611BB224(1)250(4)
250	160	0.27	BB	4	10	18	15.0	12	F611BB274(1)250(4)
250	160	0.33	BC	5	11	18	15.0	12	F611BC334(1)250(4)
250	160	0.39	BC	5	11	18	15.0	12	F611BC394(1)250(4)
250	160	0.47	BE	5.5	12.5	18	15.0	12	F611BE474(1)250(4)
250	160	0.56	BG	6	12	18	15.0	12	F611BG564(1)250(4)
250	160	0.68	BK	7.5	13.5	18	15.0	12	F611BK684(1)250(4)
250	160	0.82	BK	7.5	13.5	18	15.0	12	F611BK824(1)250(4)
250	160	1	BK	7.5	13.5	18	15.0	12	F611BK105(1)250(4)
250	160	1.2	BP	8.5	14.5	18	15.0	12	F611BP125(1)250(4)
250	160	1.5	BS	10	16	18	15.0	12	F611BS155(1)250(4)
250	160	1.8	BY	11	19	18	15.0	12	F611BY185(1)250(4)
250	160	2.2	BY	11	19	18	15.0	12	F611BY225(1)250(4)
VDC	VAC	Capacitance Value (µF)	Size Code	B (mm)	H (mm)	L (mm)	Lead Spacing (p)	dV/dt (V/µs)	Part Number

(1) K= ±10%, M = ±20%; J = ±5% on request

(2) K= ±10%, M = ±20%; J = ±5% not available

(3) M = ±20% (only available tolerance).

(4) Insert lead and packaging code. See Ordering Options Table for available options.

**Table 1 – Ratings & Part Number Reference cont'd**

VDC	VAC	Capacitance Value (µF)	Size Code	Maximum Dimensions in mm			Lead Spacing (p)	dV/dt (V/µs)	Part Number
				B	H	L			
250	160	0.82	DB	6	14.5	26	22.5	8	F611DB824(1)250(4)
250	160	1	DB	6	14.5	26	22.5	8	F611DB105(1)250(4)
250	160	1.2	DI	7	16	26	22.5	8	F611DI125(1)250(4)
250	160	1.5	DI	7	16	26	22.5	8	F611DI155(1)250(4)
250	160	1.8	DH	8	16	26	22.5	8	F611DH185(1)250(4)
250	160	2.2	DJ	8.5	17	26	22.5	8	F611DJ225(1)250(4)
250	160	2.7	DO	10	18.5	26	22.5	8	F611DO275(1)250(4)
250	160	3.3	DP	11	20	26	22.5	8	F611DP335(1)250(4)
250	160	3.9	DU	13	22	26	22.5	8	F611DU395(1)250(4)
250	160	4.7	DU	13	22	26	22.5	8	F611DU475(1)250(4)
250	160	5.6	DY	15.5	24.5	26	22.5	8	F611DY565(1)250(4)
250	160	6.8	DY	15.5	24.5	26	22.5	8	F611DY685(1)250(4)
250	160	2.2	FB	9	17	31.5	27.5	5	F611FB225(1)250(4)
250	160	2.7	FB	9	17	31.5	27.5	5	F611FB275(1)250(4)
250	160	3.3	FB	9	17	31.5	27.5	5	F611FB335(1)250(4)
250	160	3.9	FB	9	17	31.5	27.5	5	F611FB395(1)250(4)
250	160	4.7	FB	9	17	31.5	27.5	5	F611FB475(1)250(4)
250	160	5.6	FC	11	20	31.5	27.5	5	F611FC565(1)250(4)
250	160	6.8	FC	11	20	31.5	27.5	5	F611FC685(1)250(4)
250	160	8.2	FI	13	25	31.5	27.5	5	F611FI825(1)250(4)
250	160	10	FI	13	25	31.5	27.5	5	F611FI106(1)250(4)
250	160	12	FI	13	25	31.5	27.5	5	F611FI126(2)250(4)
250	160	15	FN	14	28	31.5	27.5	5	F611FN156(2)250(4)
250	160	18	FR	17.5	28	31.5	27.5	5	F611FR186(1)250(4)
250	160	22	FS	19	29	31.5	27.5	5	F611FS226(2)250(4)
250	160	27	FY	22	37	31.5	27.5	5	F611FY276(1)250(4)
250	160	33	FY	22	37	31.5	27.5	5	F611FY336(2)250(4)
250	160	5.6	RB	11	22	41	37.5	4	F611RB565(1)250(4)
250	160	6.8	RB	11	22	41	37.5	4	F611RB685(1)250(4)
250	160	8.2	RB	11	22	41	37.5	4	F611RB825(1)250(4)
250	160	10	RB	11	22	41	37.5	4	F611RB106(1)250(4)
250	160	12	RB	11	22	41	37.5	4	F611RB126(2)250(4)
250	160	15	RF	13	24	41	37.5	4	F611RF156(1)250(4)
250	160	18	RH	15	26	41	37.5	4	F611RH186(1)250(4)
250	160	22	RH	15	26	41	37.5	4	F611RH226(2)250(4)
250	160	27	RC	16	28.5	41	37.5	4	F611RC276(3)250(4)
250	160	33	RD	19	32	41	37.5	4	F611RD336(2)250(4)
250	160	39	RP	21	38	41	37.5	4	F611RP396(1)250(4)
250	160	47	RP	21	38	41	37.5	4	F611RP476(2)250(4)
250	160	56	RO	24	44	41	37.5	4	F611RO566(1)250(4)
250	160	68	RO	24	44	41	37.5	4	F611RO686(3)250(4)
250	160	82	RU	30	45	41	37.5	4	F611RU826(2)250(4)
400	200	0.001	JF	2.5	6.5	7.2	5.0	400	F612JF102(1)400(4)
400	200	0.0012	JF	2.5	6.5	7.2	5.0	400	F612JF122(1)400(4)
400	200	0.0015	JF	2.5	6.5	7.2	5.0	400	F612JF152(1)400(4)
400	200	0.0018	JF	2.5	6.5	7.2	5.0	400	F612JF182(1)400(4)
400	200	0.0022	JF	2.5	6.5	7.2	5.0	400	F612JF222(1)400(4)
400	200	0.0027	JF	2.5	6.5	7.2	5.0	400	F612JF272(1)400(4)
400	200	0.0033	JF	2.5	6.5	7.2	5.0	400	F612JF332(1)400(4)
400	200	0.0039	JF	2.5	6.5	7.2	5.0	400	F612JF392(1)400(4)
400	200	0.0047	JF	2.5	6.5	7.2	5.0	400	F612JF472(1)400(4)
400	200	0.0056	JG	3.5	7.5	7.2	5.0	400	F612JG562(1)400(4)
400	200	0.0068	JG	3.5	7.5	7.2	5.0	400	F612JG682(1)400(4)
400	200	0.082	JG	3.5	7.5	7.2	5.0	400	F612JG823(1)400(4)
400	200	0.01	JG	3.5	7.5	7.2	5.0	400	F612JG103(1)400(4)
400	200	0.012	JG	3.5	7.5	7.2	5.0	400	F612JG123(1)400(4)
400	200	0.015	JM	4.5	9.5	7.2	5.0	400	F612JM153(1)400(4)
VDC	VAC	Capacitance Value (µF)	Size Code	B (mm)	H (mm)	L (mm)	Lead Spacing (p)	dV/dt (V/µs)	Part Number

- (1) K= ±10%, M = ±20%; J = ±5% on request
- (2) K= ±10%, M = ±20%; J = ±5% not available
- (3) M = ±20% (only available tolerance).
- (4) Insert lead and packaging code. See Ordering Options Table for available options.

**Table 1 – Ratings & Part Number Reference cont'd**

VDC	VAC	Capacitance Value (µF)	Size Code	Maximum Dimensions in mm			Lead Spacing (p)	dV/dt (V/µs)	Part Number
				B	H	L			
400	200	0.018	JM	4.5	9.5	7.2	5.0	400	F612JM183(1)400(4)
400	200	0.022	JM	4.5	9.5	7.2	5.0	400	F612JM223(1)400(4)
400	200	0.027	JQ	5	10	7.2	5.0	400	F612JQ273(1)400(4)
400	200	0.033	JQ	5	10	7.2	5.0	400	F612JQ333(1)400(4)
400	200	0.039	JT	6	11	7.2	5.0	400	F612JT393(1)400(4)
400	200	0.047	JT	6	11	7.2	5.0	400	F612JT473(1)400(4)
400	200	0.056	JT	6	11	7.2	5.0	400	F612JT563(1)400(4)
400	160	0.0068	JF	2.5	6.5	7.2	5.0	200	F612JF682(1)400(4)
400	160	0.0082	JF	2.5	6.5	7.2	5.0	200	F612JF822(1)400(4)
400	160	0.015	JG	3.5	7.5	7.2	5.0	200	F612JG153(1)400(4)
400	160	0.018	JG	3.5	7.5	7.2	5.0	200	F612JG183(1)400(4)
400	160	0.033	JM	4.5	9.5	7.2	5.0	200	F612JM333(1)400(4)
400	160	0.039	JM	4.5	9.5	7.2	5.0	200	F612JM393(1)400(4)
400	160	0.047	JQ	5	10	7.2	5.0	200	F612JQ473(1)400(4)
400	160	0.068	JT	6	11	7.2	5.0	200	F612JT683(1)400(4)
400	200	0.033	AG	4	9	13	10.0	30	F611AG333(1)400(4)
400	200	0.039	AG	4	9	13	10.0	30	F611AG393(1)400(4)
400	200	0.047	AG	4	9	13	10.0	30	F611AG473(1)400(4)
400	200	0.056	AG	4	9	13	10.0	30	F611AG563(1)400(4)
400	200	0.068	AG	4	9	13	10.0	30	F611AG683(1)400(4)
400	200	0.082	AG	4	9	13	10.0	30	F611AG823(1)400(4)
400	200	0.1	AK	5	11	13	10.0	30	F611AK104(1)400(4)
400	200	0.12	AK	5	11	13	10.0	30	F611AK124(1)400(4)
400	200	0.15	AK	5	11	13	10.0	30	F611AK154(1)400(4)
400	200	0.18	AP	6	12	13	10.0	30	F611AP184(1)400(4)
400	200	0.22	AP	6	12	13	10.0	30	F611AP224(1)400(4)
400	200	0.056	BB	4	10	18	15.0	20	F611BB563(1)400(4)
400	200	0.068	BB	4	10	18	15.0	20	F611BB683(1)400(4)
400	200	0.082	BB	4	10	18	15.0	20	F611BB823(1)400(4)
400	200	0.1	BB	4	10	18	15.0	20	F611BB104(1)400(4)
400	200	0.12	BB	4	10	18	15.0	20	F611BB124(1)400(4)
400	200	0.15	BB	4	10	18	15.0	20	F611BB154(1)400(4)
400	200	0.18	BC	5	11	18	15.0	20	F611BC184(1)400(4)
400	200	0.22	BC	5	11	18	15.0	20	F611BC224(1)400(4)
400	200	0.27	BE	5.5	12.5	18	15.0	20	F611BE274(1)400(4)
400	200	0.33	BG	6	12	18	15.0	20	F611BG334(1)400(4)
400	200	0.39	BK	7.5	13.5	18	15.0	20	F611BK394(1)400(4)
400	200	0.47	BK	7.5	13.5	18	15.0	20	F611BK474(1)400(4)
400	200	0.56	BK	7.5	13.5	18	15.0	20	F611BK564(1)400(4)
400	200	0.68	BP	8.5	14.5	18	15.0	20	F611BP684(1)400(4)
400	200	0.82	BS	10	16	18	15.0	20	F611BS824(1)400(4)
400	200	1	BY	11	19	18	15.0	20	F611BY105(1)400(4)
400	200	1.2	BY	11	19	18	15.0	20	F611BY125(1)400(4)
400	200	1.5	BY	11	19	18	15.0	20	F611BY155(1)400(4)
400	200	0.27	DB	6	14.5	26	22.5	10	F611DB274(1)400(4)
400	200	0.33	DB	6	14.5	26	22.5	10	F611DB334(1)400(4)
400	200	0.39	DB	6	14.5	26	22.5	10	F611DB394(1)400(4)
400	200	0.47	DB	6	14.5	26	22.5	10	F611DB474(1)400(4)
400	200	0.56	DB	6	14.5	26	22.5	10	F611DB564(1)400(4)
400	200	0.68	DB	6	14.5	26	22.5	10	F611DB684(1)400(4)
400	200	0.82	DI	7	16	26	22.5	10	F611DI824(1)400(4)
400	200	1	DI	7	16	26	22.5	10	F611DI105(1)400(4)
400	200	1.2	DJ	8.5	17	26	22.5	10	F611DJ125(1)400(4)
400	200	1.5	DM	9	18.5	26	22.5	10	F611DM155(1)400(4)
400	200	1.8	DO	10	18.5	26	22.5	10	F611DO185(1)400(4)
400	200	2.2	DP	11	20	26	22.5	10	F611DP225(1)400(4)
400	200	2.7	DU	13	22	26	22.5	10	F611DU275(1)400(4)

(1) K= ±10%, M = ±20%; J = ±5% on request

(2) K= ±10%, M = ±20%; J = ±5% not available

(3) M = ±20% (only available tolerance).

(4) Insert lead and packaging code. See Ordering Options Table for available options.

**Table 1 – Ratings & Part Number Reference cont'd**

VDC	VAC	Capacitance Value (µF)	Size Code	Maximum Dimensions in mm			Lead Spacing (p)	dV/dt (V/µs)	Part Number
				B	H	L			
400	200	3.3	DU	13	22	26	22.5	10	F611DU335(1)400(4)
400	200	3.9	DY	15.5	24.5	26	22.5	10	F611DY395(1)400(4)
400	200	4.7	DY	15.5	24.5	26	22.5	10	F611DY475(1)400(4)
400	200	0.82	FB	9	17	31.5	27.5	8.5	F611FB824(1)400(4)
400	200	1	FB	9	17	31.5	27.5	8.5	F611FB105(1)400(4)
400	200	1.2	FB	9	17	31.5	27.5	8.5	F611FB125(1)400(4)
400	200	1.5	FB	9	17	31.5	27.5	8.5	F611FB155(1)400(4)
400	200	1.8	FB	9	17	31.5	27.5	8.5	F611FB185(1)400(4)
400	200	2.2	FC	11	20	31.5	27.5	8.5	F611FC225(1)400(4)
400	200	2.7	FC	11	20	31.5	27.5	8.5	F611FC275(1)400(4)
400	200	3.3	FI	13	25	31.5	27.5	8.5	F611FI335(1)400(4)
400	200	3.9	FI	13	25	31.5	27.5	8.5	F611FI395(1)400(4)
400	200	4.7	FI	13	25	31.5	27.5	8.5	F611FI475(2)400(4)
400	200	5.6	FN	14	28	31.5	27.5	8.5	F611FN565(2)400(4)
400	200	6.8	FR	17.5	28	31.5	27.5	8.5	F611FR685(2)400(4)
400	200	8.2	FR	17.5	28	31.5	27.5	8.5	F611FR825(3)400(4)
400	200	10	FY	22	37	31.5	27.5	8.5	F611FY106(2)400(4)
400	200	12	FY	22	37	31.5	27.5	8.5	F611FY126(2)400(4)
400	200	15	FY	22	37	31.5	27.5	8.5	F611FY156(3)400(4)
400	200	2.2	RB	11	22	41	37.5	6	F611RB225(1)400(4)
400	200	2.7	RB	11	22	41	37.5	6	F611RB275(1)400(4)
400	200	3.3	RB	11	22	41	37.5	6	F611RB335(1)400(4)
400	200	3.9	RB	11	22	41	37.5	6	F611RB395(1)400(4)
400	200	4.7	RB	11	22	41	37.5	6	F611RB475(2)400(4)
400	200	5.6	RF	13	24	41	37.5	6	F611RF565(1)400(4)
400	200	6.8	RF	13	24	41	37.5	6	F611RF685(3)400(4)
400	200	8.2	RH	15	26	41	37.5	6	F611RH825(2)400(4)
400	200	10	RC	16	28.5	41	37.5	6	F611RC106(2)400(4)
400	200	12	RD	19	32	41	37.5	6	F611RD126(2)400(4)
400	200	15	RP	21	38	41	37.5	6	F611RP156(1)400(4)
400	200	18	RP	21	38	41	37.5	6	F611RP186(2)400(4)
400	200	22	RO	24	44	41	37.5	6	F611RO226(1)400(4)
400	200	27	RO	24	44	41	37.5	6	F611RO276(3)400(4)
400	200	33	RU	30	45	41	37.5	6	F611RU336(3)400(4)
630	220	0.0012	JF	2.5	6.5	7.2	5.0	80	F611JF122(1)630(4)
630	220	0.0015	JF	2.5	6.5	7.2	5.0	80	F611JF152(1)630(4)
630	220	0.0018	JF	2.5	6.5	7.2	5.0	80	F611JF182(1)630(4)
630	220	0.0022	JF	2.5	6.5	7.2	5.0	80	F611JF222(1)630(4)
630	220	0.0027	JF	2.5	6.5	7.2	5.0	80	F611JF272(1)630(4)
630	220	0.0033	JF	2.5	6.5	7.2	5.0	80	F611JF332(1)630(4)
630	220	0.0039	JF	2.5	6.5	7.2	5.0	80	F611JF392(1)630(4)
630	220	0.0047	JG	3.5	7.5	7.2	5.0	80	F611JG472(1)630(4)
630	220	0.0056	JG	3.5	7.5	7.2	5.0	80	F611JG562(1)630(4)
630	220	0.0068	JG	3.5	7.5	7.2	5.0	80	F611JG682(1)630(4)
630	220	0.0082	JG	3.5	7.5	7.2	5.0	80	F611JG822(1)630(4)
630	220	0.01	JG	3.5	7.5	7.2	5.0	80	F611JG103(1)630(4)
630	220	0.012	JM	4.5	9.5	7.2	5.0	80	F611JM123(1)630(4)
630	220	0.015	JM	4.5	9.5	7.2	5.0	80	F611JM153(1)630(4)
630	220	0.018	JM	4.5	9.5	7.2	5.0	80	F611JM183(1)630(4)
630	220	0.022	JQ	5	10	7.2	5.0	80	F611JQ223(1)630(4)
630	220	0.027	JT	6	11	7.2	5.0	80	F611JT273(1)630(4)
630	220	0.033	JT	6	11	7.2	5.0	80	F611JT333(1)630(4)
630	220	0.039	JU	7.2	13	7.2	5.0	80	F611JU393(1)630(4)
630	220	0.047	JU	7.2	13	7.2	5.0	80	F611JU473(1)630(4)
630	220	0.0018	KE	2.5	6	10	7.5	60	F611KE182(1)630(4)
630	220	0.0022	KE	2.5	6	10	7.5	60	F611KE222(1)630(4)
630	220	0.0027	KE	2.5	6	10	7.5	60	F611KE272(1)630(4)
VDC	VAC	Capacitance Value (µF)	Size Code	B (mm)	H (mm)	L (mm)	Lead Spacing (p)	dV/dt (V/µs)	Part Number

(1) K= ±10%, M = ±20%; J = ±5% on request

(2) K= ±10%, M = ±20%; J = ±5% not available

(3) M = ±20% (only available tolerance).

(4) Insert lead and packaging code. See Ordering Options Table for available options.

**Table 1 – Ratings & Part Number Reference cont'd**

VDC	VAC	Capacitance Value (µF)	Size Code	Maximum Dimensions in mm			Lead Spacing (p)	dV/dt (V/µs)	Part Number
				B	H	L			
630	220	0.0033	KE	2.5	6	10	7.5	60	F611KE332(1)630(4)
630	220	0.0039	KE	2.5	6	10	7.5	60	F611KE392(1)630(4)
630	220	0.0047	KE	2.5	6	10	7.5	60	F611KE472(1)630(4)
630	220	0.0056	KF	3	8	10	7.5	60	F611KF562(1)630(4)
630	220	0.0068	KF	3	8	10	7.5	60	F611KF682(1)630(4)
630	220	0.0082	KF	3	8	10	7.5	60	F611KF822(1)630(4)
630	220	0.01	KF	3	8	10	7.5	60	F611KF103(1)630(4)
630	220	0.012	KG	4	8	10	7.5	60	F611KG123(1)630(4)
630	220	0.015	KG	4	8	10	7.5	60	F611KG153(1)630(4)
630	220	0.018	KG	4	8	10	7.5	60	F611KG183(1)630(4)
630	220	0.022	KJ	5	10.5	10	7.5	60	F611KJ223(1)630(4)
630	220	0.027	KJ	5	10.5	10	7.5	60	F611KJ273(1)630(4)
630	220	0.033	KJ	5	10.5	10	7.5	60	F611KJ333(1)630(4)
630	220	0.039	KJ	5	10.5	10	7.5	60	F611KJ393(1)630(4)
630	220	0.047	KM	6	12	10.5	7.5	60	F611KM473(1)630(4)
630	220	0.056	KM	6	12	10.5	7.5	60	F611KM563(1)630(4)
630	220	0.012	AG	4	9	13	10.0	40	F611AG123(1)630(4)
630	220	0.015	AG	4	9	13	10.0	40	F611AG153(1)630(4)
630	220	0.018	AG	4	9	13	10.0	40	F611AG183(1)630(4)
630	220	0.022	AG	4	9	13	10.0	40	F611AG223(1)630(4)
630	220	0.027	AG	4	9	13	10.0	40	F611AG273(1)630(4)
630	220	0.033	AK	5	11	13	10.0	40	F611AK333(1)630(4)
630	220	0.039	AK	5	11	13	10.0	40	F611AK393(1)630(4)
630	220	0.047	AK	5	11	13	10.0	40	F611AK473(1)630(4)
630	220	0.056	AP	6	12	13	10.0	40	F611AP563(1)630(4)
630	220	0.068	AP	6	12	13	10.0	40	F611AP683(1)630(4)
630	220	0.082	AP	6	12	13	10.0	40	F611AP823(1)630(4)
630	220	0.022	BB	4	10	18	15.0	25	F611BB223(1)630(4)
630	220	0.027	BB	4	10	18	15.0	25	F611BB273(1)630(4)
630	220	0.033	BB	4	10	18	15.0	25	F611BB333(1)630(4)
630	220	0.039	BB	4	10	18	15.0	25	F611BB393(1)630(4)
630	220	0.047	BB	4	10	18	15.0	25	F611BB473(1)630(4)
630	220	0.056	BC	5	11	18	15.0	25	F611BC563(1)630(4)
630	220	0.068	BC	5	11	18	15.0	25	F611BC683(1)630(4)
630	220	0.082	BC	5	11	18	15.0	25	F611BC823(1)630(4)
630	220	0.1	BE	5.5	12.5	18	15.0	25	F611BE104(1)630(4)
630	220	0.12	BG	6	12	18	15.0	25	F611BG124(1)630(4)
630	220	0.15	BK	7.5	13.5	18	15.0	25	F611BK154(1)630(4)
630	220	0.18	BK	7.5	13.5	18	15.0	25	F611BK184(1)630(4)
630	220	0.22	BP	8.5	14.5	18	15.0	25	F611BP224(1)630(4)
630	220	0.27	BS	10	16	18	15.0	25	F611BS274(1)630(4)
630	220	0.33	BS	10	16	18	15.0	25	F611BS334(1)630(4)
630	220	0.39	BY	11	19	18	15.0	25	F611BY394(1)630(4)
630	220	0.47	BY	11	19	18	15.0	25	F611BY474(1)630(4)
630	220	0.12	DB	6	14.5	26	22.5	12	F611DB124(1)630(4)
630	220	0.15	DB	6	14.5	26	22.5	12	F611DB154(1)630(4)
630	220	0.18	DB	6	14.5	26	22.5	12	F611DB184(1)630(4)
630	220	0.22	DB	6	14.5	26	22.5	12	F611DB224(1)630(4)
630	220	0.27	DI	7	16	26	22.5	12	F611DI274(1)630(4)
630	220	0.33	DI	7	16	26	22.5	12	F611DI334(1)630(4)
630	220	0.39	DH	8	16	26	22.5	12	F611DH394(1)630(4)
630	220	0.47	DJ	8.5	17	26	22.5	12	F611DJ474(1)630(4)
630	220	0.56	DM	9	18.5	26	22.5	12	F611DM564(1)630(4)
630	220	0.68	DO	10	18.5	26	22.5	12	F611DO684(1)630(4)
630	220	0.82	DP	11	20	26	22.5	12	F611DP824(1)630(4)
630	220	1	DU	13	22	26	22.5	12	F611DU105(1)630(4)
630	220	1.2	DY	15.5	24.5	26	22.5	12	F611DY125(1)630(4)

(1) K= ±10%, M = ±20%; J = ±5% on request

(2) K= ±10%, M = ±20%; J = ±5% not available

(3) M = ±20% (only available tolerance).

(4) Insert lead and packaging code. See Ordering Options Table for available options.

**Table 1 – Ratings & Part Number Reference cont'd**

VDC	VAC	Capacitance Value (µF)	Size Code	Maximum Dimensions in mm			Lead Spacing (p)	dV/dt (V/µs)	Part Number
				B	H	L			
630	220	1.5	DY	15.5	24.5	26	22.5	12	F611DY155(1)630(4)
630	220	0.33	FB	9	17	31.5	27.5	10	F611FB334(1)630(4)
630	220	0.39	FB	9	17	31.5	27.5	10	F611FB394(1)630(4)
630	220	0.47	FB	9	17	31.5	27.5	10	F611FB474(1)630(4)
630	220	0.56	FB	9	17	31.5	27.5	10	F611FB564(1)630(4)
630	220	0.68	FB	9	17	31.5	27.5	10	F611FB684(2)630(4)
630	220	0.82	FC	11	20	31.5	27.5	10	F611FC824(1)630(4)
630	220	1	FC	11	20	31.5	27.5	10	F611FC105(2)630(4)
630	220	1.2	FI	13	25	31.5	27.5	10	F611FI125(1)630(4)
630	220	1.5	FI	13	25	31.5	27.5	10	F611FI155(2)630(4)
630	220	1.8	FI	13	25	31.5	27.5	10	F611FI185(3)630(4)
630	220	2.2	FN	14	28	31.5	27.5	10	F611FN225(3)630(4)
630	220	2.2	FR	17.5	28	31.5	27.5	10	F611FR225(1)630(4)
630	220	2.7	FR	17.5	28	31.5	27.5	10	F611FR275(3)630(4)
630	220	3.3	FY	19	29	31.5	27.5	10	F611FY335(2)630(4)
630	220	3.9	FY	22	37	31.5	27.5	10	F611FY395(1)630(4)
630	220	4.7	FY	22	37	31.5	27.5	10	F611FY475(3)630(4)
630	220	0.82	RB	11	22	41	37.5	8	F611RB824(1)630(4)
630	220	1	RB	11	22	41	37.5	8	F611RB105(1)630(4)
630	220	1.2	RB	11	22	41	37.5	8	F611RB125(1)630(4)
630	220	1.5	RB	11	22	41	37.5	8	F611RB155(1)630(4)
630	220	1.8	RB	11	22	41	37.5	8	F611RB185(3)630(4)
630	220	2.2	RF	13	24	41	37.5	8	F611RF225(1)630(4)
630	220	2.7	RH	15	26	41	37.5	8	F611RH275(1)630(4)
630	220	3.3	RC	16	28.5	41	37.5	8	F611RC335(1)630(4)
630	220	3.9	RD	19	32	41	37.5	8	F611RD395(1)630(4)
630	220	4.7	RD	19	32	41	37.5	8	F611RD475(2)630(4)
630	220	5.6	RP	21	38	41	37.5	8	F611RP565(1)630(4)
630	220	6.8	RP	21	38	41	37.5	8	F611RP685(2)630(4)
630	220	8.2	RO	24	44	41	37.5	8	F611RO825(1)630(4)
630	220	10	RO	24	44	41	37.5	8	F611RO106(3)630(4)
630	220	12	RU	30	45	41	37.5	8	F611RU126(3)630(4)
1000	250	0.001	JF	2.5	6.5	7.2	5.0	100	F611JF102(1)1K0(4)
1000	250	0.0012	JG	3.5	7.5	7.2	5.0	100	F611JG122(1)1K0(4)
1000	250	0.0015	JG	3.5	7.5	7.2	5.0	100	F611JG152(1)1K0(4)
1000	250	0.0018	JG	3.5	7.5	7.2	5.0	100	F611JG182(1)1K0(4)
1000	250	0.0022	JG	3.5	7.5	7.2	5.0	100	F611JG222(1)1K0(4)
1000	250	0.0027	JG	3.5	7.5	7.2	5.0	100	F611JG272(1)1K0(4)
1000	250	0.0033	JG	3.5	7.5	7.2	5.0	100	F611JG332(1)1K0(4)
1000	250	0.0039	JM	4.5	9.5	7.2	5.0	100	F611JM392(1)1K0(4)
1000	250	0.0047	JM	4.5	9.5	7.2	5.0	100	F611JM472(1)1K0(4)
1000	250	0.0056	JM	4.5	9.5	7.2	5.0	100	F611JM562(1)1K0(4)
1000	250	0.0068	JQ	5	10	7.2	5.0	100	F611JQ682(1)1K0(4)
1000	250	0.0082	JT	6	11	7.2	5.0	100	F611JT822(1)1K0(4)
1000	250	0.01	JT	6	11	7.2	5.0	100	F611JT103(1)1K0(4)
1000	250	0.012	JT	6	11	7.2	5.0	100	F611JT123(1)1K0(4)
1000	250	0.015	JU	7.2	13	7.2	5.0	100	F611JU153(1)1K0(4)
1000	250	0.001	KE	2.5	6	10	7.5	80	F611KE102(1)1K0(4)
1000	250	0.0012	KE	2.5	6	10	7.5	80	F611KE122(1)1K0(4)
1000	250	0.0015	KE	2.5	6	10	7.5	80	F611KE152(1)1K0(4)
1000	250	0.0018	KF	3	8	10	7.5	80	F611KF182(1)1K0(4)
1000	250	0.0022	KF	3	8	10	7.5	80	F611KF222(1)1K0(4)
1000	250	0.0027	KF	3	8	10	7.5	80	F611KF272(1)1K0(4)
1000	250	0.0033	KF	3	8	10	7.5	80	F611KF332(1)1K0(4)
1000	250	0.0039	KG	4	8	10	7.5	80	F611KG392(1)1K0(4)
1000	250	0.0047	KG	4	8	10	7.5	80	F611KG472(1)1K0(4)
1000	250	0.0056	KG	4	8	10	7.5	80	F611KG562(1)1K0(4)
VDC	VAC	Capacitance Value (µF)	Size Code	B (mm)	H (mm)	L (mm)	Lead Spacing (p)	dV/dt (V/µs)	Part Number

(1) K= ±10%, M = ±20%; J = ±5% on request

(2) K= ±10%, M = ±20%; J = ±5% not available

(3) M = ±20% (only available tolerance).

(4) Insert lead and packaging code. See Ordering Options Table for available options.

**Table 1 – Ratings & Part Number Reference cont'd**

VDC	VAC	Capacitance Value (µF)	Size Code	Maximum Dimensions in mm			Lead Spacing (p)	dV/dt (V/µs)	Part Number
				B	H	L			
1000	250	0.0068	KG	4	8	10	7.5	80	F611KG682(1)1K0(4)
1000	250	0.0082	KJ	5	10.5	10	7.5	80	F611KJ822(1)1K0(4)
1000	250	0.01	KJ	5	10.5	10	7.5	80	F611KJ103(1)1K0(4)
1000	250	0.012	KJ	5	10.5	10	7.5	80	F611KJ123(1)1K0(4)
1000	250	0.015	KM	6	12	10.5	7.5	80	F611KM153(1)1K0(4)
1000	250	0.018	KM	6	12	10.5	7.5	80	F611KM183(1)1K0(4)
1000	250	0.022	KM	6	12	10.5	7.5	80	F611KM223(1)1K0(4)
1000	250	0.001	AG	4	9	13	10.0	60	F611AG102(1)1K0(4)
1000	250	0.0012	AG	4	9	13	10.0	60	F611AG122(1)1K0(4)
1000	250	0.0015	AG	4	9	13	10.0	60	F611AG152(1)1K0(4)
1000	250	0.0018	AG	4	9	13	10.0	60	F611AG182(1)1K0(4)
1000	250	0.0022	AG	4	9	13	10.0	60	F611AG222(1)1K0(4)
1000	250	0.0027	AG	4	9	13	10.0	60	F611AG272(1)1K0(4)
1000	250	0.0033	AG	4	9	13	10.0	60	F611AG332(1)1K0(4)
1000	250	0.0039	AG	4	9	13	10.0	60	F611AG392(1)1K0(4)
1000	250	0.0047	AG	4	9	13	10.0	60	F611AG472(1)1K0(4)
1000	250	0.0056	AG	4	9	13	10.0	60	F611AG562(1)1K0(4)
1000	250	0.0068	AG	4	9	13	10.0	60	F611AG682(1)1K0(4)
1000	250	0.0082	AG	4	9	13	10.0	60	F611AG822(1)1K0(4)
1000	250	0.01	AG	4	9	13	10.0	60	F611AG103(1)1K0(4)
1000	250	0.012	AG	4	9	13	10.0	60	F611AG123(1)1K0(4)
1000	250	0.015	AK	5	11	13	10.0	60	F611AK153(1)1K0(4)
1000	250	0.018	AK	5	11	13	10.0	60	F611AK183(1)1K0(4)
1000	250	0.022	AP	6	12	13	10.0	60	F611AP223(1)1K0(4)
1000	250	0.027	AP	6	12	13	10.0	60	F611AP273(1)1K0(4)
1000	250	0.033	AP	6	12	13	10.0	60	F611AP333(1)1K0(4)
1000	250	0.0082	BB	4	10	18	15.0	30	F611BB822(1)1K0(4)
1000	250	0.01	BB	4	10	18	15.0	30	F611BB103(1)1K0(4)
1000	250	0.012	BB	4	10	18	15.0	30	F611BB123(1)1K0(4)
1000	250	0.015	BB	4	10	18	15.0	30	F611BB153(1)1K0(4)
1000	250	0.018	BB	4	10	18	15.0	30	F611BB183(1)1K0(4)
1000	250	0.022	BC	5	11	18	15.0	30	F611BC223(1)1K0(4)
1000	250	0.027	BC	5	11	18	15.0	30	F611BC273(1)1K0(4)
1000	250	0.033	BC	5	11	18	15.0	30	F611BC333(1)1K0(4)
1000	250	0.039	BE	5.5	12.5	18	15.0	30	F611BE393(1)1K0(4)
1000	250	0.047	BG	6	12	18	15.0	30	F611BG473(1)1K0(4)
1000	250	0.056	BK	7.5	13.5	18	15.0	30	F611BK563(1)1K0(4)
1000	250	0.068	BK	7.5	13.5	18	15.0	30	F611BK683(1)1K0(4)
1000	250	0.082	BP	8.5	14.5	18	15.0	30	F611BP823(1)1K0(4)
1000	250	0.1	BP	8.5	14.5	18	15.0	30	F611BP104(1)1K0(4)
1000	250	0.12	BS	10	16	18	15.0	30	F611BS124(1)1K0(4)
1000	250	0.15	BY	11	19	18	15.0	30	F611BY154(1)1K0(4)
1000	250	0.18	BY	11	19	18	15.0	30	F611BY184(1)1K0(4)
1000	250	0.033	DB	6	14.5	26	22.5	15	F611DB333(1)1K0(4)
1000	250	0.039	DB	6	14.5	26	22.5	15	F611DB393(1)1K0(4)
1000	250	0.047	DB	6	14.5	26	22.5	15	F611DB473(1)1K0(4)
1000	250	0.056	DB	6	14.5	26	22.5	15	F611DB563(1)1K0(4)
1000	250	0.068	DB	6	14.5	26	22.5	15	F611DB683(1)1K0(4)
1000	250	0.082	DB	6	14.5	26	22.5	15	F611DB823(1)1K0(4)
1000	250	0.1	DB	6	14.5	26	22.5	15	F611DB104(1)1K0(4)
1000	250	0.12	DI	7	16	26	22.5	15	F611DI124(1)1K0(4)
1000	250	0.15	DI	7	16	26	22.5	15	F611DI154(1)1K0(4)
1000	250	0.18	DH	8	16	26	22.5	15	F611DH184(1)1K0(4)
1000	250	0.22	DM	9	18.5	26	22.5	15	F611DM224(1)1K0(4)
1000	250	0.27	DO	10	18.5	26	22.5	15	F611DO274(1)1K0(4)
1000	250	0.33	DP	11	20	26	22.5	15	F611DP334(1)1K0(4)
1000	250	0.39	DU	13	22	26	22.5	15	F611DU394(1)1K0(4)
VDC	VAC	Capacitance Value (µF)	Size Code	B (mm)	H (mm)	L (mm)	Lead Spacing (p)	dV/dt (V/µs)	Part Number

(1) K= ±10%, M = ±20%; J = ±5% on request

(2) K= ±10%, M = ±20%; J = ±5% not available

(3) M = ±20% (only available tolerance).

(4) Insert lead and packaging code. See Ordering Options Table for available options.



**Table 1 – Ratings & Part Number Reference cont'd**

VDC	VAC	Capacitance Value (µF)	Size Code	Maximum Dimensions in mm			Lead Spacing (p)	dV/dt (V/µs)	Part Number
				B	H	L			
1000	250	0.47	DU	13	22	26	22.5	15	F611DU474(1)1K0(4)
1000	250	0.56	DY	15.5	24.5	26	22.5	15	F611DY564(1)1K0(4)
1000	250	0.68	DY	15.5	24.5	26	22.5	15	F611DY684(1)1K0(4)
1000	250	0.15	FB	9	17	31.5	27.5	12	F611FB154(1)1K0(4)
1000	250	0.18	FB	9	17	31.5	27.5	12	F611FB184(1)1K0(4)
1000	250	0.22	FB	9	17	31.5	27.5	12	F611FB224(1)1K0(4)
1000	250	0.27	FB	9	17	31.5	27.5	12	F611FB274(1)1K0(4)
1000	250	0.33	FB	9	17	31.5	27.5	12	F611FB334(3)1K0(4)
1000	250	0.39	FC	11	20	31.5	27.5	12	F611FC394(1)1K0(4)
1000	250	0.47	FC	11	20	31.5	27.5	12	F611FC474(2)1K0(4)
1000	250	0.56	FI	13	25	31.5	27.5	12	F611FI564(1)1K0(4)
1000	250	0.68	FI	13	25	31.5	27.5	12	F611FI684(2)1K0(4)
1000	250	0.82	FN	14	28	31.5	27.5	12	F611FN824(2)1K0(4)
1000	250	1	FR	17.5	28	31.5	27.5	12	F611FR105(1)1K0(4)
1000	250	1.2	FR	17.5	28	31.5	27.5	12	F611FR125(3)1K0(4)
1000	250	1.5	FS	19	29	31.5	27.5	12	F611FS155(3)1K0(4)
1000	250	1.8	FY	22	37	31.5	27.5	12	F611FY185(1)1K0(4)
1000	250	2.2	FY	22	37	31.5	27.5	12	F611FY225(3)1K0(4)
1000	250	0.47	RB	11	22	41	37.5	10	F611RB474(1)1K0(4)
1000	250	0.56	RB	11	22	41	37.5	10	F611RB564(1)1K0(4)
1000	250	0.68	RB	11	22	41	37.5	10	F611RB684(1)1K0(4)
1000	250	0.82	RF	13	24	41	37.5	10	F611RF824(1)1K0(4)
1000	250	1	RF	13	24	41	37.5	10	F611RF105(2)1K0(4)
1000	250	1.2	RH	15	26	41	37.5	10	F611RH125(1)1K0(4)
1000	250	1.5	RC	16	28.5	41	37.5	10	F611RC155(2)1K0(4)
1000	250	1.8	RD	19	32	41	37.5	10	F611RD185(1)1K0(4)
1000	250	2.2	RD	19	32	41	37.5	10	F611RD225(3)1K0(4)
1000	250	2.7	RP	21	38	41	37.5	10	F611RP275(2)1K0(4)
1000	250	3.3	RO	24	44	41	37.5	10	F611RO335(1)1K0(4)
1000	250	3.9	RO	24	44	41	37.5	10	F611RO395(2)1K0(4)
1000	250	4.7	RU	30	45	41	37.5	10	F611RU475(1)1K0(4)
1000	250	5.6	RU	30	45	41	37.5	10	F611RU565(3)1K0(4)
VDC	VAC	Capacitance Value (µF)	Size Code	B (mm)	H (mm)	L (mm)	Lead Spacing (p)	dV/dt (V/µs)	Part Number

- (1) K= ±10%, M = ±20%; J = ±5% on request  
 (2) K= ±10%, M = ±20%; J = ±5% not available  
 (3) M = ±20% (only available tolerance).  
 (4) Insert lead and packaging code. See Ordering Options Table for available options.

## Soldering Process

The implementation of the RoHS directive has resulted in the selection of SnAgCu (SAC) alloys or SnCu alloys as primary solder. This has increased the liquidus temperature from that of 183°C for SnPb eutectic alloy to 217 – 221°C for the new alloys. As a result, the heat stress to the components, even in wave soldering, has increased considerably due to higher pre-heat and wave temperatures. Polypropylene capacitors are especially sensitive to heat (the melting point of polypropylene is 160 – 170°C). Wave soldering can be destructive, especially for mechanically small polypropylene capacitors (with lead spacing of 5 mm to 15 mm), and great care has to be taken during soldering. The recommended solder profiles from KEMET should be used. Please consult KEMET with any questions. In general, the wave soldering curve from IEC Publication 61760-1 Edition 2 serves as a solid guideline for successful soldering. Please see Figure 1.

Reflow soldering is not recommended for through-hole film capacitors. Exposing capacitors to a soldering profile in excess of the above the recommended limits may result to degradation or permanent damage to the capacitors.

Do not place the polypropylene capacitor through an adhesive curing oven to cure resin for surface mount components. Insert through-hole parts after the curing of surface mount parts. Consult KEMET to discuss the actual temperature profile in the oven, if through-hole components must pass through the adhesive curing process. A maximum two soldering cycles is recommended. Please allow time for the capacitor surface temperature to return to a normal temperature before the second soldering cycle.

### Manual Soldering Recommendations

Following is the recommendation for manual soldering with a soldering iron.

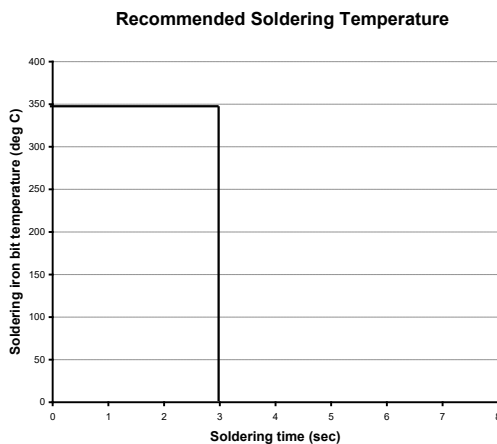

The soldering iron tip temperature should be set at 350°C (+10°C maximum) with the soldering duration not to exceed more than 3 seconds.

### Wave Soldering Recommendations

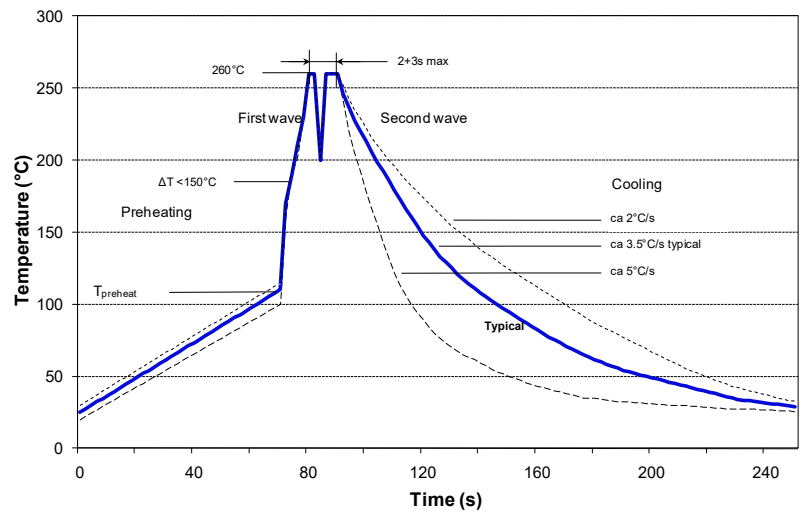

## Soldering Process cont'd

### Wave Soldering Recommendations cont'd

1. The table indicates the maximum set-up temperature of the soldering process  
 Figure 1

Dielectric Film Material	Maximum Preheat Temperature			Maximum Peak Soldering Temperature	
	Capacitor Pitch ≤ 10 mm	Capacitor Pitch = 15 mm	Capacitor Pitch > 15 mm	Capacitor Pitch ≤ 15 mm	Capacitor Pitch > 15 mm
Polyester	130°C	130°C	130°C	270°C	270°C
Polypropylene	100°C	110°C	130°C	260°C	270°C
Paper	130°C	130°C	140°C	270°C	270°C
Polyphenylene Sulphide	150°C	150°C	160°C	270°C	270°C

2. The maximum temperature measured inside the capacitor:

Set the temperature so that inside the element the maximum temperature is below the limit:

Dielectric Film Material	Maximum temperature measured inside the element
Polyester	160°C
Polypropylene	110°C
Paper	160°C
Polyphenylene sulphide	160°C

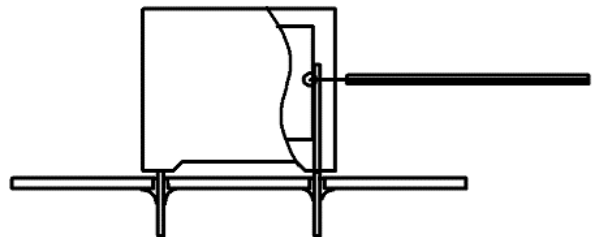

*Temperature monitored inside the capacitor.*

### Selective Soldering Recommendations

Selective dip soldering is a variation of reflow soldering. In this method, the printed circuit board with through-hole components to be soldered is preheated and transported over the solder bath as in normal flow soldering without touching the solder. When the board is over the bath, it is stopped and pre-designed solder pots are lifted from the bath with molten solder only at the places of the selected components, and pressed against the lower surface of the board to solder the components.

The temperature profile for selective soldering is similar to the double wave flow soldering outlined in this document, **however, instead of two baths, there is only one bath with a time from 3 to 10 seconds.** In selective soldering, the risk of overheating is greater than in double wave flow soldering, and great care must be taken so that the parts are not overheated.

## Construction

### Wound

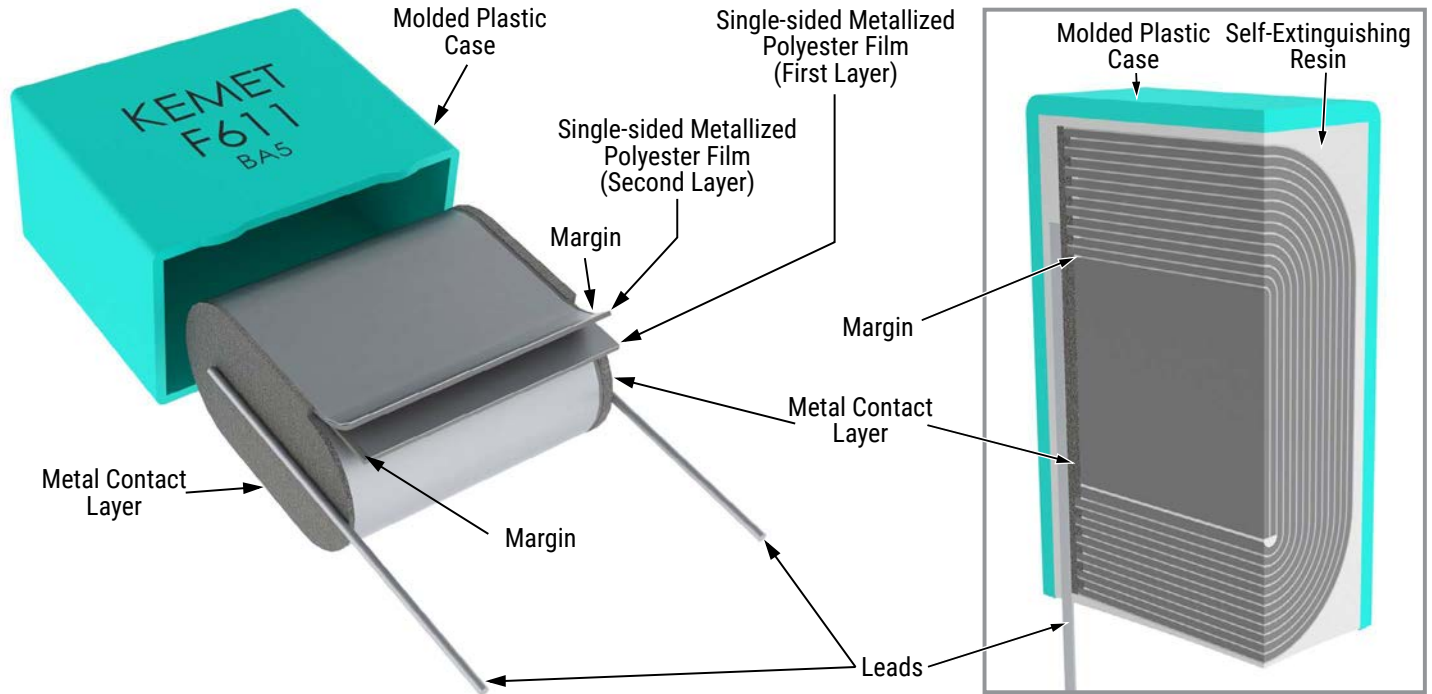

### Winding Scheme

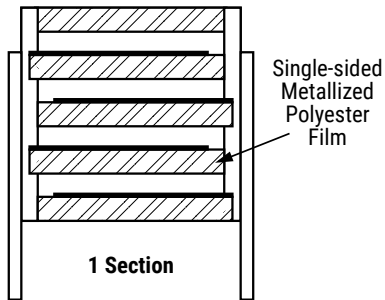

## Construction cont'd

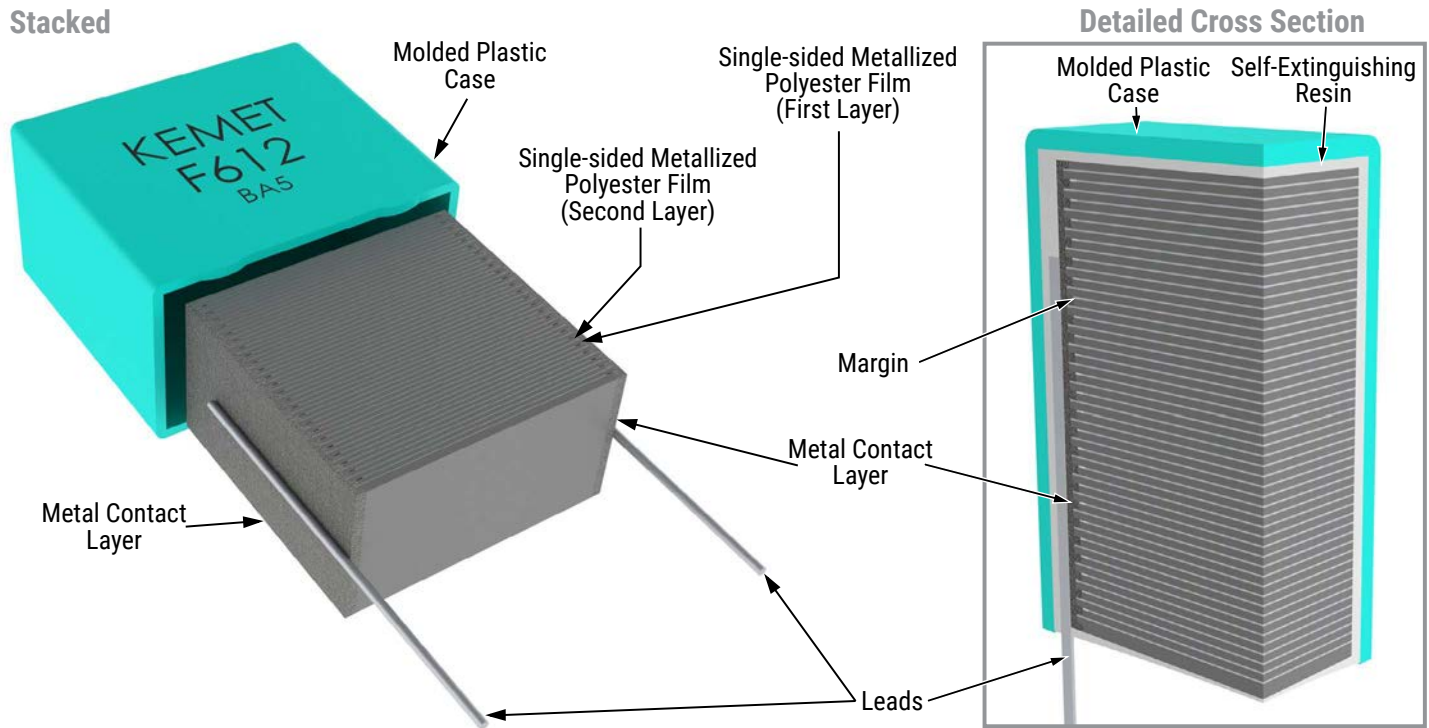

## Marking

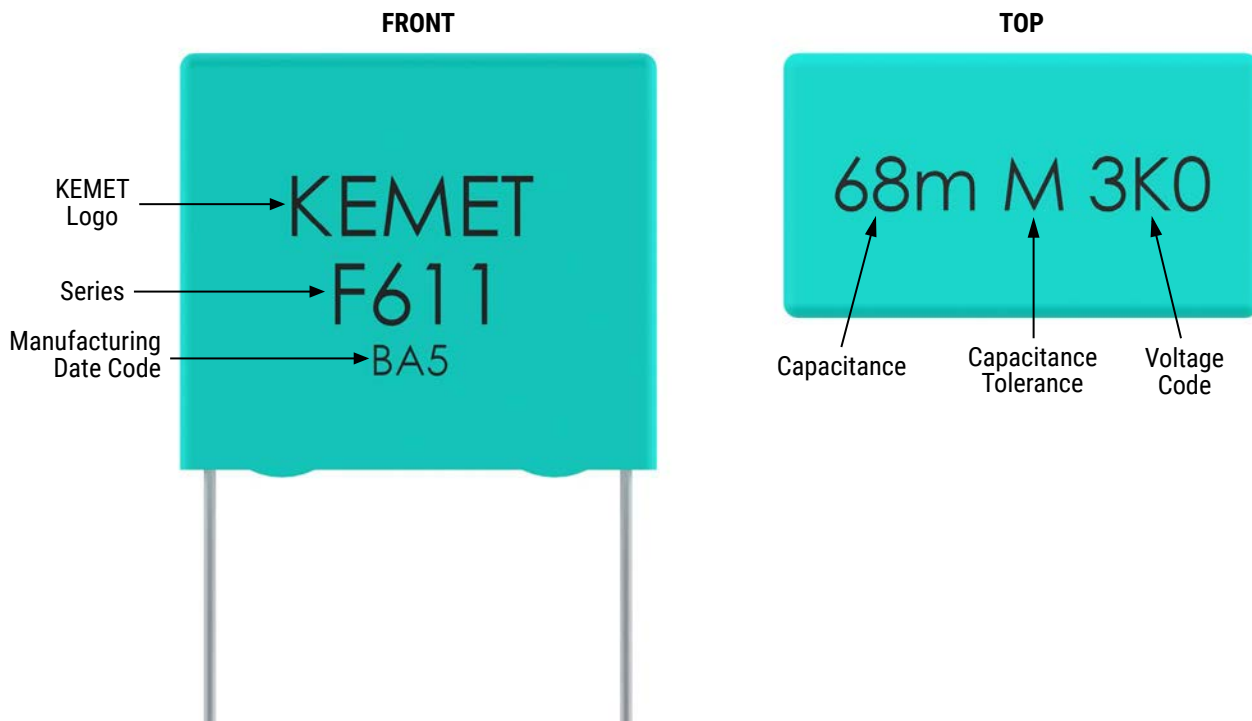

## Packaging Quantities

Size Code	Lead Spacing	Thickness (mm)	Height (mm)	Length (mm)	Bulk Short Leads	Bulk Long Leads	Standard Reel ø 355 mm	Large Reel ø 500 mm	Ammo	Pizza
JF	5	2.5	6.5	7.2	3000	4000	2500		3500	
JG		3.5	7.5	7.2	2000	3000	1800		2500	
JM		4.5	9.5	7.2	1500	2000	1400		1900	
JQ		5.0	10.0	7.2	1000	1500	1200		1700	
JT		6	11	7.2	2000	1000	1000		1400	
JU		7.2	13	7.2	1500	750	800		1150	
KE	7.5	2.5	6	10	2000	3000	2500		3500	
KF		3	8	10	1500	1750	2100		2800	
KG		4	8	10	2000	1500	1500		2100	
KJ		5	10.5	10	1500	1000	1200		1600	
KM		6	12	10.5	1000	800	1000		1350	
KH		4	9	10	2000	1500	1500		2100	
AN	10	3.5	9	13	2200	3200	850	1700	1150	
AG		4	9	13	2000	2200	750	1500	1000	
AK		5	11	13	1300	2000	600	1250	800	
AP		6	12	13	1000	1800	500	1000	680	
AO		7	17	13	600	900	450	900	580	
AL		9.5	7.5	13	1100	2000	300	600	430	
AE		4	8	13	2000	2200	750	1500	1000	
BB	15	4	10	18	1300	1500	750	1500	1000	1411
BC		5	11	18	1000	1250	600	1250	800	1139
BE		5.5	12.5	18	800	1100	550	1100	750	1020
BG		6	12	18	1750	1000	500	1000	680	935
BK		7.5	13.5	18	1000	800	350	800	500	748
BI		6	17.5	18	1000	800	500	1000	680	935
BP		8.5	14.5	18	1000	650	300	700	440	663
BT		9	12.5	18	1000	700	270	650	410	629
BO		7.5	18.5	18	900	600	350	800	500	748
BS		10	16	18	750	550	300	600	380	561
BR		13	12	18	750	520	200	480	280	425
BY		11	19	18	450	400	250	500	340	510
BA		8.5	12.5	18	1000	650	300	700	440	663
BZ		12	20	18	350	300	220	450	330	459

## Packaging Quantities cont'd

Size Code	Lead Spacing	Thickness (mm)	Height (mm)	Length (mm)	Bulk Short Leads	Bulk Long Leads	Standard Reel ø 355 mm	Large Reel ø 500 mm	Ammo	Pizza
DB	<b>22.5</b>	6	14.5	26	1638	702	300	700	464	660
DI		7	16	26	1188	594	250	550	380	564
DH		8.0	16.0	26	1026	513	240	500	330	492
DJ		8.5	17	26	972	486	250	450	280	468
DM		9	18.5	26	918	459	200	400	300	444
DO		10	18.5	26	810	405	160	350	235	396
DP		11	20	26	756	378	190	350	217	360
DU		13	22	26	540	324	150	300	200	300
DY		15.5	24.5	26	450	270	120	250	170	252
FB	<b>27.5</b>	9.0	17.0	31.5	816	408				370
FC		11.0	20.0	31.5	672	336				300
FI		13.0	25.0	31.5	480	288				250
FN		14.0	28.0	31.5	352	176				230
FO		17.0	40.0	31.5	216	144				190
FR		17.5	28.0	31.5	256	128				190
FS		19.0	29.0	31.5	256	128				170
FY		22.0	37.0	31.5	168	112				150
FH		21.0	12.5	31.5	392	168				150
FQ		27.5	16.0	31.5	280	120				120
FT		31.0	19.0	31.5	240	120				100
RB	<b>37.5</b>	11.0	22.0	41.0	420	252				210
RF		13.0	24.0	41.0	360	216				175
RH		15.0	26.0	41.0	300	180				154
RC		16.0	28.5	41.0	216	108				140
RD		19.0	32.0	41.0	192	96				119
RP		21.0	38.0	41.0	126	84				105
RO		24.0	44.0	41.0	108	72				91
RU		30.0	45.0	41.0	90	60				77
RV		24.0	15.0	41.0	252	108				91
RW		24.0	19.0	41.0	216	108				91

## Lead Taping & Packaging (IEC 60286-2)

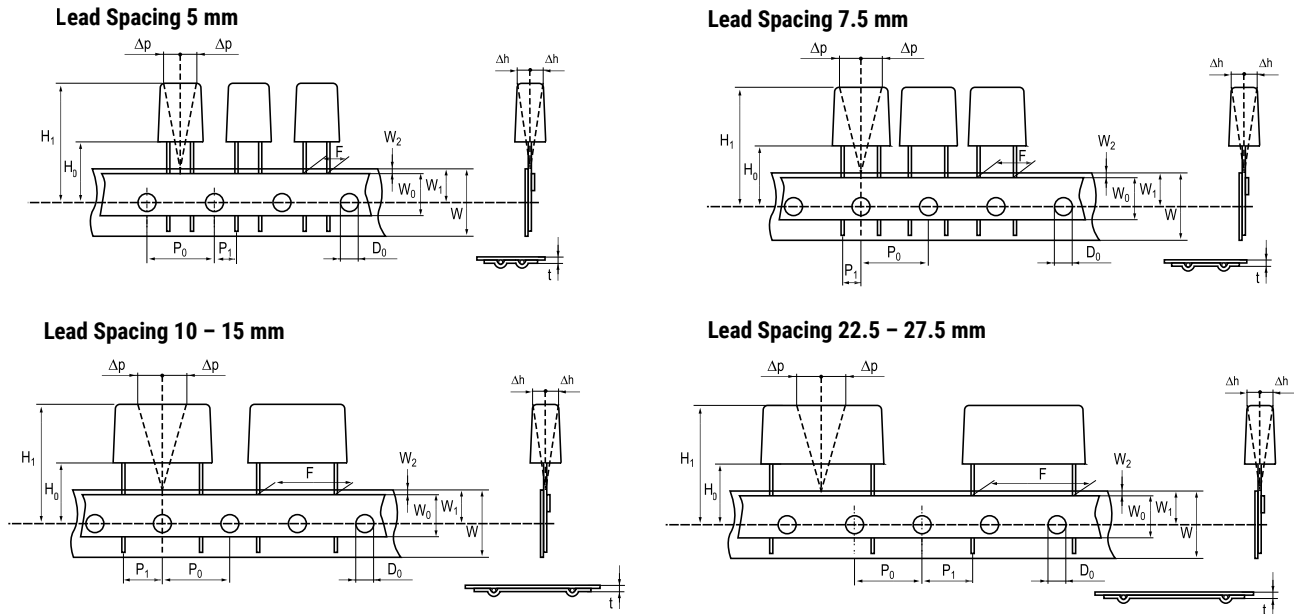

## Taping Specification

Dimensions in mm									Standard IEC 60286-2
Lead spacing	+6/-0.1	F	5	7.5	10	15	22.5	27.5	F
Carrier tape width	+1/-0.5	W	18	18	18	18	18	18	18 <sup>+1/-0.5</sup>
Hold-down tape width	Minimum	$W_0$	6	6	9	10	10	10	
Position of sprocket hole	+/-0.5	$W_1$	9	9	9	9	9	9	9 <sup>+0.75/-0.5</sup>
Distance between tapes	Maximum	$W_2$	3	3	3	3	3	3	3
Sprocket hole diameter	+/-0.2	$D_0$	4	4	4	4	4	4	4
Feed hole lead spacing	+/-0.2 <sup>(1)</sup>	$P_0$ <sup>(3)</sup>	12.7	12.7	12.7	12.7	12.7	12.7	12.7
Distance lead - feed hole	+/-0.7	$P_1$	3.85	3.75	7.7	5.2	7.8	5.3	$P_1$
Deviation tape - plane	Maximum	$\Delta p$	1.3	1.3	1.3	1.3	1.3	1.3	1.3
Lateral deviation	+/-2	$\Delta h$	2	2	2	2	2	2	2
Total thickness	+/-0.2	t	0.7	0.7	0.7	0.7	0.9 <sup>MAX</sup>	0.9 <sup>MAX</sup>	0.9 <sup>MAX</sup>
Sprocket hole/cap body	+/-0.5	$H_0$ <sup>(2)</sup>	18.5 <sup>+/-0.5</sup>	18.5 <sup>+/-0.5</sup>	18.5 <sup>+/-0.5</sup>	18.5 <sup>+/-0.5</sup>	18.5 <sup>+/-0.5</sup>	18.5 <sup>+/-0.5</sup>	18 <sup>+2/-0</sup>

(1) Maximum cumulative feed hole error, 1 mm per 20 parts.

(2) 16.5 mm available on request.

(3) 15 mm available on request ( $F \geq 10$  mm).



## Lead Taping & Packaging (IEC 60286-2) cont'd

### Ammo Specifications

Series	Dimensions (mm)		
	H	W	T
R4x, R4x+R, R7x, RSB	360	340	59
F5A, F5B, F5D			
F6xx, F8xx			
PHExxx, PMExxx, PMRxxx	330	330	50



### Reel Specifications

Series	Dimensions (mm)		
	D	H	W
R4x, R4x+R, R7x, RSB	355 500	30	55 (Max)
F5A, F5B, F5D		25	
F6xx, F8xx			
PHExxx, PMExxx, PMRxxx	360 500	30	46 (Max)

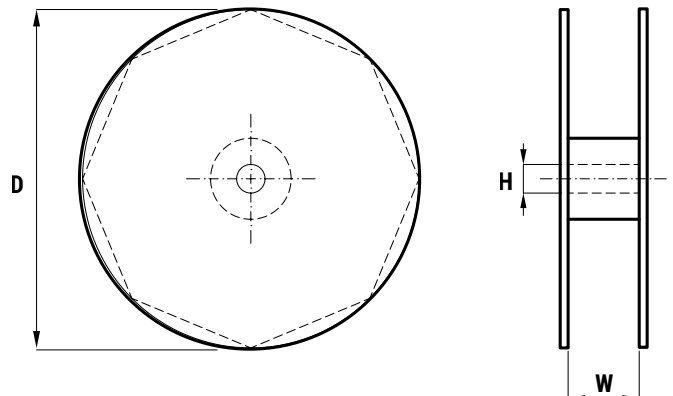

### Manufacturing Date Code (IEC-60062)

Y = Year, Z = Month			
Year	Code	Month	Code
2000	M	January	1
2001	N	February	2
2002	P	March	3
2003	R	April	4
2004	S	May	5
2005	T	June	6
2006	U	July	7
2007	V	August	8
2008	W	September	9
2009	X	October	0
2010	A	November	N
2011	B	December	D
2012	C		
2013	D		
2014	E		
2015	F		
2016	H		
2017	J		
2018	K		
2019	L		
2020	M		

## KEMET Electronic Corporation Sales Offices

For a complete list of our global sales offices, please visit [www.kemet.com/sales](http://www.kemet.com/sales).

---

### Disclaimer

All product specifications, statements, information and data (collectively, the "Information") in this datasheet are subject to change. The customer is responsible for checking and verifying the extent to which the Information contained in this publication is applicable to an order at the time the order is placed.

All Information given herein is believed to be accurate and reliable, but it is presented without guarantee, warranty, or responsibility of any kind, expressed or implied.

Statements of suitability for certain applications are based on KEMET Electronics Corporation's ("KEMET") knowledge of typical operating conditions for such applications, but are not intended to constitute – and KEMET specifically disclaims – any warranty concerning suitability for a specific customer application or use. The Information is intended for use only by customers who have the requisite experience and capability to determine the correct products for their application. Any technical advice inferred from this Information or otherwise provided by KEMET with reference to the use of KEMET's products is given gratis, and KEMET assumes no obligation or liability for the advice given or results obtained.

Although KEMET designs and manufactures its products to the most stringent quality and safety standards, given the current state of the art, isolated component failures may still occur. Accordingly, customer applications which require a high degree of reliability or safety should employ suitable designs or other safeguards (such as installation of protective circuitry or redundancies) in order to ensure that the failure of an electrical component does not result in a risk of personal injury or property damage.

Although all product-related warnings, cautions and notes must be observed, the customer should not assume that all safety measures are indicated or that other measures may not be required.

*KEMET is a registered trademark of KEMET Electronics Corporation.*