

RIGHT ANGLE PLUG SOLDER TYPE

R125.153.002

CABLE .085

Series : SMA

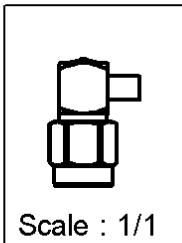
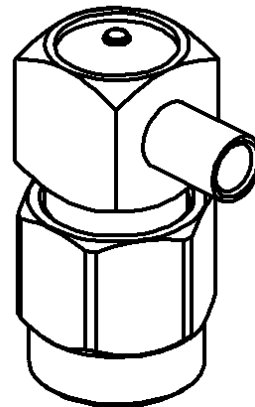
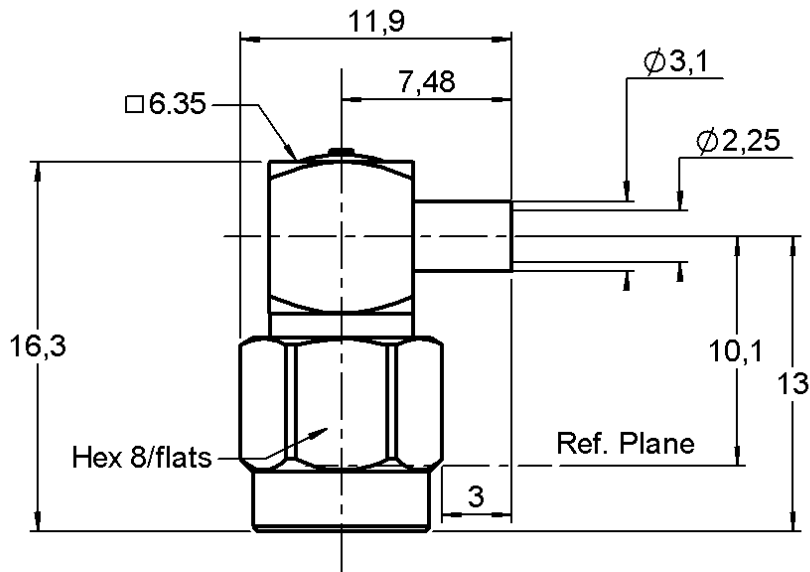

CECC 22111-803-04

All dimensions are in mm.



COMPONENTS	MATERIALS	PLATINGS (µm)
BODY	STAINLESS STEEL	GOLD 0.5 OVER NICKEL 2
CENTER CONTACT	BRASS	GOLD 1.3 OVER NICKEL 2
OUTER CONTACT	-	-
INSULATOR	PTFE	-
GASKET	SILICONE RUBBER	-
OTHERS PARTS	STAINLESS STEEL	PASSIVATED .
-	-	-
-	-	-

Issue : 0122 E

In the effort to improve our products, we reserve the right to make changes judged to be necessary.



RIGHT ANGLE PLUG SOLDER TYPE

R125.153.002

CABLE .085

Series : SMA

PACKAGING

Standard	Unit	Other
100	'W' option	Contact us

SPECIFICATION

ELECTRICAL CHARACTERISTICS

Impedance		50 Ω
Frequency		0-12.4 GHz
VSWR	1.10 +	0.010 x F(GHz) Maxi
Insertion loss		0.05 √F(GHz) dB Maxi
RF leakage	- (90 - F(GHz)) dB Maxi
Voltage rating		335 Veff Maxi
Dielectric withstanding voltage		750 Veff mini
Insulation resistance		5000 MΩ mini

CABLE ASSEMBLY

Stripping	a	b	c	d	e	f
mm	3.17	0.00	0.00	0.00	0.00	0.00

Assembly instruction : **Solder 02**

Recommended cable(s)
RG 405
KS 1

Cable retention
- pull off **130** N mini
- torque **NA** N.cm

MECHANICAL CHARACTERISTICS

Center contact retention		
Axial force – Mating end	27	N mini
Axial force – Opposite end	27	N mini
Torque	2.8	N.cm mini

Recommended torque		
Mating	100	N.cm
Panel nut	NA	N.cm
Clamp nut	NA	N.cm
A/F clamp nut	0.000	mm

Mating life	500	Cycles mini
Weight	3.825	g

TOOLING

Part Number	Description	Hexagon
.	.	.
R282.120.010	SMA TOOLBOX	
R282.051.000	STRIPPING TOOL	
R282.063.000	POINTER GAUGE	
R282.740.000	SOLDERING MOUNTING	
R282.744.200	SOLDERING POSITIONER FOR RIGHT ANGLE SMA	

OTHERS CHARACTERISTICS

-

ENVIRONMENTAL

Operating temperature	-65/+105	° C
Hermetic seal	NA	Atm.cm3/s
Panel leakage	NA	

Issue : 0122 E

In the effort to improve our products, we reserve the right to make changes judged to be necessary.

