

TURCK

YOUR AUTOMATION SOLUTIONS PROVIDER



PROXIMITY SENSORS



CORDSETS



I/O SOLUTIONS



MEASUREMENT



RFID



INTERFACE MODULES



CUSTOM CONNECTIVITY



POSITION



NETWORK MEDIA

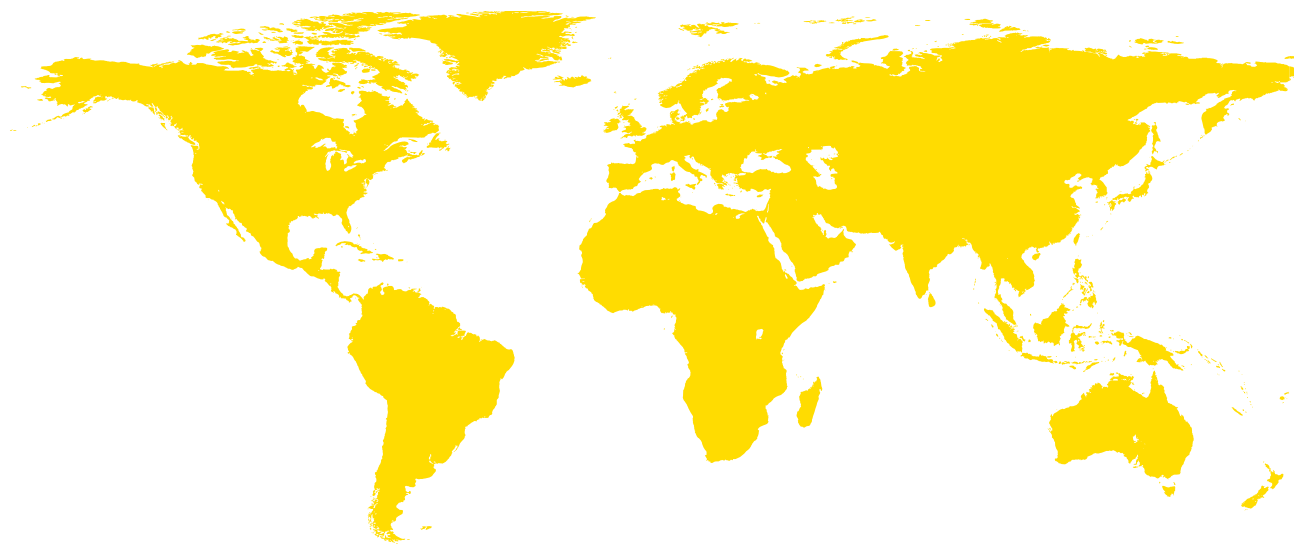

TURCK's global support network consists of over 2,500 employees in 25 countries and 60 exclusive agencies worldwide that strive to meet customer expectations. Our sales, support and manufacturing facilities are strategically located across the world allowing us to respond to local market conditions and deliver customer specific solutions on a timely basis.

We are a world leader in automation technology with a diverse and broad product portfolio that provides customer specific applications with high performance, reliable and cost effective solutions. The synergy in our product portfolio and customization flexibility are key components of our value proposition.

Our expertise spans across two major industry categories: Industrial Automation and Process Automation. Each weighs in with its own unique requirements and methods of conducting business. This market centric approach ensures that we develop application specific solutions across a variety of vertical market segments.



RELECO by TURCK RELAYS

Introduction	6
Relays	15
Sockets	63
Timers	83

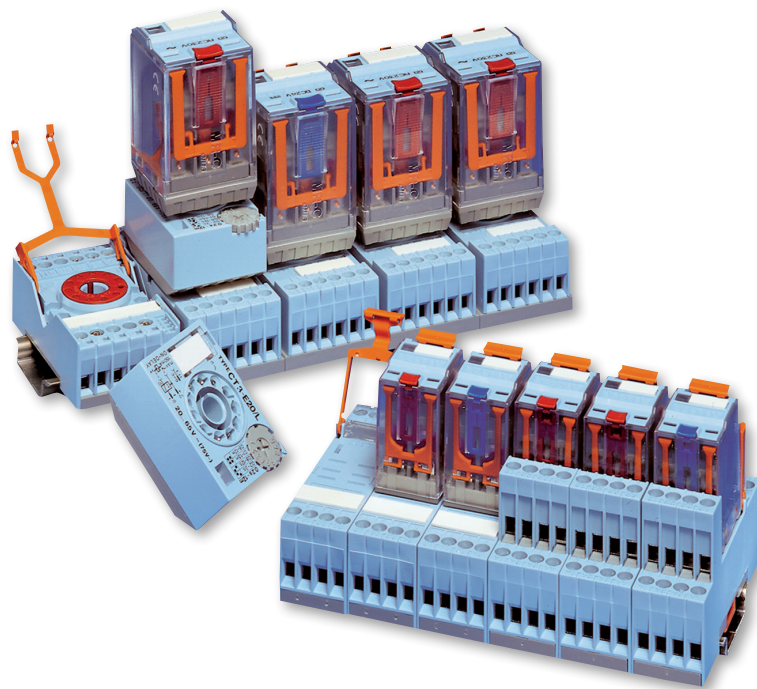

Application	Types		Poles	AC Ratings	DC Ratings	Page	Sockets	Page
General Purpose	C2-A20	Universal 8-Pin, Standard	2	10 A @ 250 V	0.5 A @ 110 V	12	S2	57-58
	C3-A30	Universal 11-Pin, Standard	3	10 A @ 250 V	0.5 A @ 110 V	15	S3	58-60
	C4-A40	Square Base, 4-Pole	4	10 A @ 250 V	0.5 A @ 110 V	24	S4	61-62
	C5-A20	Square Base, AC Power	2	16 A @ 500 V	0.5 A @ 110 V	27	S5	62-64
	C5-A30	Square Base, AC Power	3	16 A @ 400 V	0.5 A @ 110 V	28	S5	62-64
	C7-A10	Miniature, AC Power	1	16 A @ 250 V	0.5 A @ 110 V	34	S7	65-68
	C7-A20	Miniature, AC Power	2	10 A @ 250 V	0.5 A @ 110 V	35	S7	65-68
	C7-A20E	Miniature, AC Power	2	10 A @ 250 V	0.5 A @ 110 V	36	S7	65-68
	C9-A41	Miniature, 14-Pin Plug-in	4	5 A @ 250 V	0.2 A @ 110 V	43	S9	68-69
	C10-A10	Interface Standard	1	10 A @ 250 V	0.5 A @ 110 V	46	S10	70-71
	C12-A21	Interface Standard	2	5 A @ 250 V	0.5 A @ 110 V	49	S12	71-72

Bifurcated Contacts Low Level Loads	C2-T21	Universal 8-Pin Plug-in	2	6 A @ 250 V	6 A @ 30 V	13	S2	57-58
	C3-T31	Universal 11-Pin Plug-in	3	6 A @ 250 V	6 A @ 30 V	16	S3	58-60
	C7-T21	Miniature	2	6 A @ 250 V	6 A @ 30 V	37	S7	65-68
	C10-T13	Interface Twin	1	6 A @ 250 V	6 A @ 30 V	48	S10	70-71

Open Contacts DC Load Switching Flag Not Available	C2-G20	Universal 8-Pin Plug-in	2	10 A @ 250 V	1.2 A @ 110 V	14	S2	57-58
	C3-G30	Universal 11-Pin Plug-in	3	10 A @ 250 V	1.2 A @ 110 V	17	S3	58-60
	C5-G30	Square Base	3	16 A @ 400 V	1.2 A @ 110 V	27	S5	62-64
	C7-G20	Miniature	2	10 A @ 250 V	0.8 A @ 110 V	38	S7	65-68
	C10-G10	Interface N.O.	1	10 A @ 250 V	0.8 A @ 110 V	47	S10	70-71
	C12-G21	Interface N.O.	2	5 A @ 250 V	0.8 A @ 110 V	50	S12	71-72
Flag Available								

Double Make DC Load Switching	C3-X10	11-Pin, DC Power	1	10 A @ 250 V	7 A @ 110 V	19	S3	58-60
	C4-X20	Square Base, DC Power	2	10 A @ 250 V	7 A @ 110 V	25	S4	61-62
	C5-X10	Square Base, DC Power	1	16 A @ 400 V	7 A @ 110 V	30	S5	62-64
Flag Not Available	C7-X10	Miniature, DC Power	1	10 A @ 250 V	6 A @ 110 V	39	S7	65-68

Application	Types		Poles	AC Ratings	DC Ratings	Page	Sockets	Page
Latching	C3-R20	11-Pin Plug-in	2	10 A @ 250 V	0.5 A @ 110 V	20	S3	58-60
	C4-R30	Square Base, 14-Pin	3	10 A @ 250 V	0.5 A @ 110 V	26	S4	61-62
	C5-R20	Square Base	3	10 A @ 400 V	0.5 A @ 110 V	33	S5	62-64
LED Not Available	C9-R21	Miniature	2	5 A @ 250 V	0.2 A @ 110 V	44	S9	68-69
Magnet Blow-out	C3-M10	11-Pin Plug-in, High DC Load	1	10 A @ 250 V	10 A @ 220 V	18	S3	58-60
	C5-M10	Square Base, High DC Load	1	16 A @ 400 V	10 A @ 220 V	31	S5	62-64
	C5-M20	Square Base, High DC Load	2	16 A @ 250 V	7 A @ 110 V	32	S5	62-64
Sensitive 500 mW - 800 mw Flag Not Available	C3-E24	Universal 11-Pin Plug-in	2	6 A @ 250 V	6 A @ 30 V	21	S3	58-60
	C3-N34	Universal 11-Pin Plug-in	3	6 A @ 250 V	6 A @ 30 V	22	S3	58-60
	C9-E21	Miniature	2	5 A @ 250 V	5 A @ 30 V	45	S9	68-69
Lamp Switching	C7-W10	Miniature, FASTON 187	1	10 A @ 250 V	0.5 A @ 110 V	40	S7	65-68
Railway Applications	R3-N30D	Universal 11-Pin Plug-in	3	6 A @ 250 V	6 A @ 30 V	23	S3	58-60
	R7-A20D	Miniature	2	10 A @ 250 V	10 A @ 30 V	41	S7	65-68
	R7-T21D	Miniature, Twin Contacts	2	6 A @ 250 V	6 A @ 30 V	42	S7	65-68
Solid State Relay	CSS-AC	Instantaneous	1	3 A @ 250 V	N/A	53	S10	70-71
	CSS-AZ	Zero-cross	1	3 A @ 250 V	N/A	54	S10	70-71
	CSS-DCN	Common Negative	1	N/A	2 A @ 50 V	52	S10	70-71
	CSS-DCP	Common Positive	1	N/A	2 A @ 50 V	51	S10	70-71
Time Cube	CT2	8-Pin Plug-in Timer Module	2	10 A @ 250 V	0.5 A @ 110 V	74-75	S2	57-58
	CT3	11-Pin Plug-in Timer Module	3	10 A @ 250 V	0.5 A @ 110 V	74-75	S3	58-60



System Features & Benefits

Five Colors for Easy Identification of Coil Voltage

AC		Red: 120 VAC
		Maroon: AC other than 120 V
DC		Grey: VAC/DC (UC)
		Dark Blue: DC other than 24 V
		Blue: 24 VDC

If you do not want the lockable function, you can use the orange dead-man-push-button. S0-OP for MRC and S9-OP for QRC (5 piece bag).

• **Dead-man-push-button**

A black blanking plug is available if you don't want a test button. S0-NP for MRC and S9-NP for QRC (5 piece bag).

• **Blanking Plug**

Comprehensive Technical Label

C3-A 30 X /...V
 AC 2,2 VA - DC 1,3 W

Wiring diagrams showing terminal connections (A1, A2, 1, 2, 3, 4, 5, 6, 7, 8, 9, 10, 11, 12, 14, 22, 24, 32, 34).

Specifications:
 IEC / EN 60947 - 4 / - 5 10A AC1
 250V Pol.3 6A AC15

Approvals: CE, PG, Lloyd's, UL, A003850, LR 38486

Performance: 1/6 HP 120 Vac, 1/3 HP 250 Vac, 10A 300 Vac, MAX. 1200 VA, 10A 120 Vac, 6A 250 Vac

www.releco.com FAX + 34 91 641 21 93

- Coil Power
- Wiring diagram with sequential and DIN numbers
- Electrical diagram showing all additions to the coil
- Maximum switching capacity according to EN 60947 (IEC 947)
- Approvals

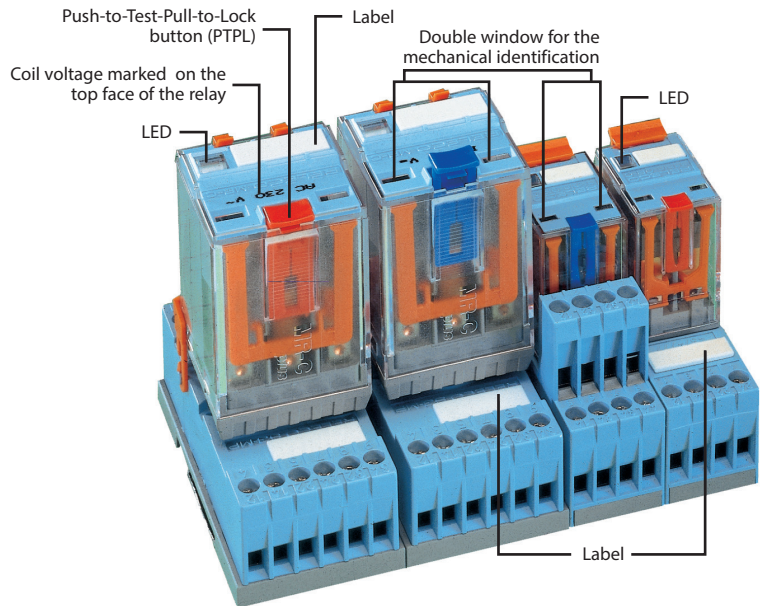
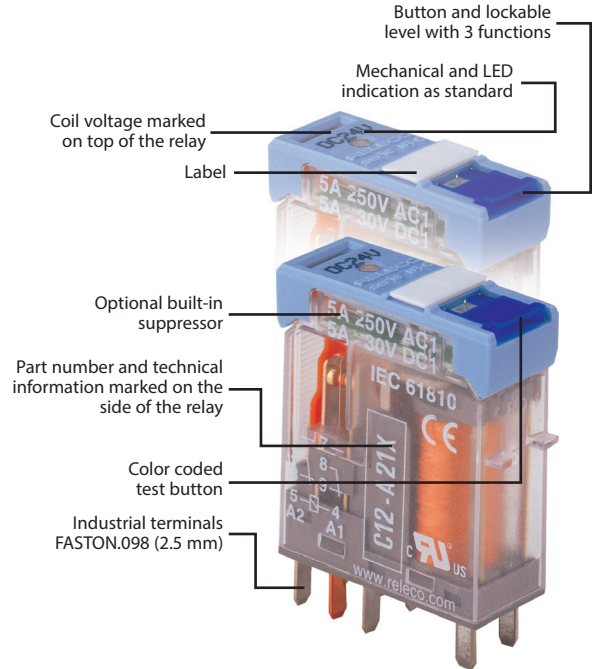

Country	Approval	Country	Approval
Canada	Authority: CSA Specification: C 22.2; UL 508	United Kingdom	Authority: Lloyd's Register of Shipping
China	Authority: CQC Specification: GB14048.5-2001		
Russia	Authority: KORPORATSIA STANDARD Specification: GOST R 50030.5.1	USA	Authority: UL Specification: C 22.2; UL 508

Industrial Relays MRC, QRC, IRC Part Number Key

Part Number Keys are to assist in IDENTIFICATION ONLY. Consult factory for catalog items not identified.

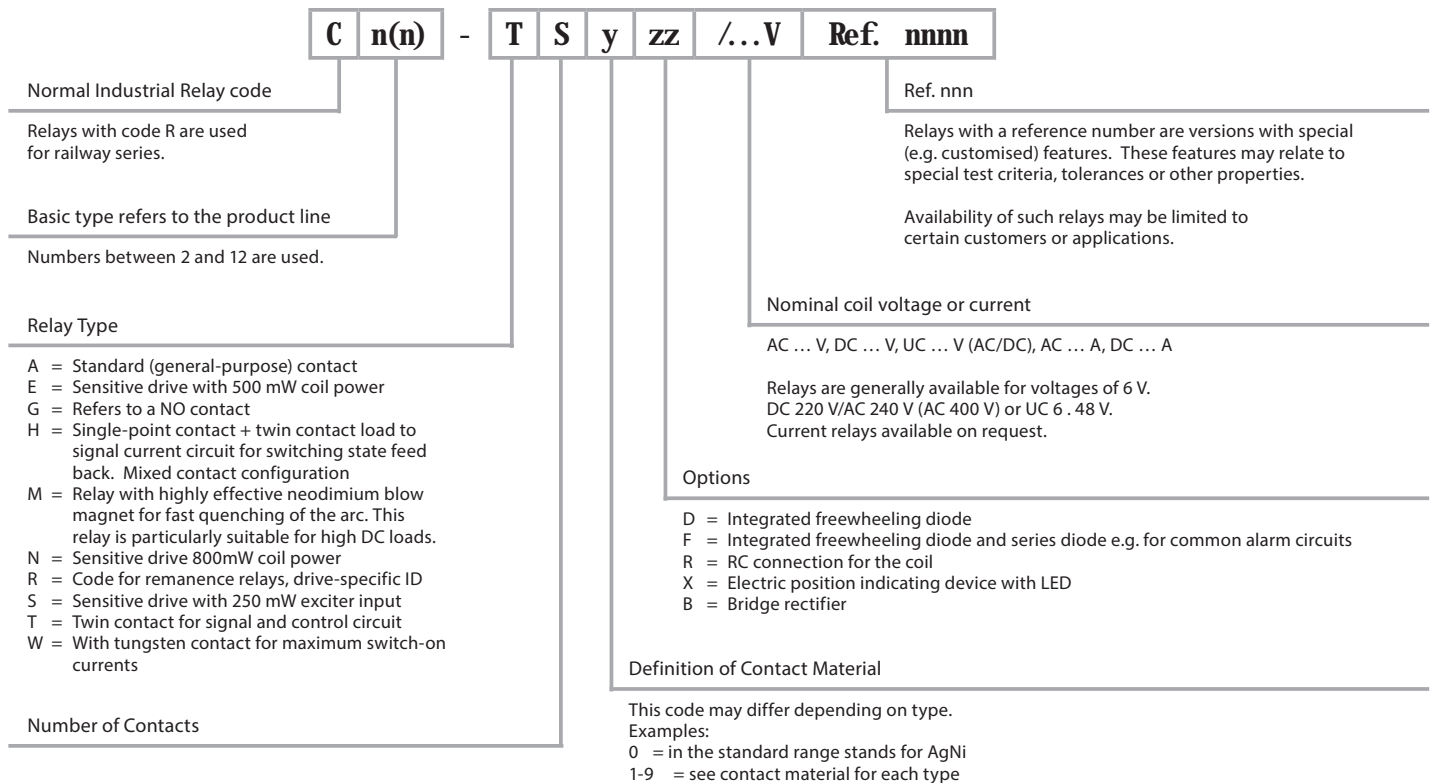

Product range

Releco offers a wide range of relay types and versions and associated bases and accessories.

Standard (general-purpose) relay, MRC series

35 x 35 mm round plug-in relay, 8- or 11- terminals multipole connector according to IEC 67 with 2 or 3 contacts up to 10 A and different contact types and contact materials. Standard relay 35 x 35 mm with flat blade connectors with up to 4 contacts and up to 16 A with 3 contacts.

Miniature industrial relay, QRC series

22.5 mm series with up to 4 contacts and up to 10 A with 1 or 2 contacts

Interface relay, IRC series

Overall width 13 mm with up to 2 electromechanical contacts, or fully electronic switches.

Special relays, remanence relays

While "normal" relays are monostable, i.e. they return to the idle state when the excitation is switched off, remanence relays are bistable, i.e. the current switching state is retained irrespective of the excitation. Relays of this type are available in different versions.

Electronic relay, CSS

In the IRC series different electronic DC or AC relays up to 3 A are available. For AC relays a distinction is made between synchronously (zero crossing) and asynchronously switching versions. For switching transformer loads we recommended using asynchronously switching semiconductor switches. For incandescent lamp loads etc. synchronously switching switches are ideal for avoiding high switch-on currents.

Accessories

Suitable bases are available for the different relay series for DIN rail mounting or panel mounting. In addition, retaining clips are available for the relays, some of which are included in the scope of supply. Suitable bridges for cost-saving wiring in series are also available.

Terminology and Technical Information

Contact Materials

Silver-nickel (AgNi) and silver-tin oxide (AgSnO₂) are used as standard contact materials for all models. Other contact materials are available on request.

Gold Flash

For relays that are intended to be stored or remain unoperated for any length of time, a 0.2μ layer of gold protects the contacts from oxidization.

Gold Plating

Increases the operational reliability. It should be used for switching low level currents.

Contact Resistance

Contact resistance is dependent on contact material, contact pressure and contact contamination.

High contact resistance raises the temperature of the contacts, therefore reducing their working life. Typical contact resistance of the MR-C and QR-C relays is 50 mΩ.

Contacts Gap

Contact gap and opening speed of the contacts have an influence on the length and the duration of the arc.

In the case of AC, a gap of 0.5 mm is sufficient to quench the arc which occurs automatically at the "zero point" of the cycle.

In the case of DC, the arc only quenches when the contact gap is sufficient for the voltage and current applied. Please see tables of "Max. DC Current".

Coil Materials

Coil bobbins are molded in polybutylene with fiberglass (130°C).

Enamelled wires of Class F specification are used (155°C).

They are wound on precision automation winding machines, with the number of turns and wire tension accurately regulated and monitored.

Tolerances

Coil resistance is measured at 20°C and is regulated within ±10% of specified value.

Standard Windings

The coil voltages indicated in the catalog refer to standard windings. Other coil voltages are available, including products for series connection and amperometric applications. Please consult your distributor for details.

Maximum Intensity

The "Max. switching current" indicated in every model, refers to the maximum stable current which should be possible in permanent conduction (ITH).

In the case of AC, the "Max. switching current" that the relay can support is the same for all the values of voltages ≤ of the "Max. switching voltage" specified in every model.

The product of the intensity and the voltage applied should not be higher than the values specified as "Max. AC load".

In the case of DC, the "Max. switching current" must be less than the current that causes the continuous arcing.

The tables of "Max. DC current" show the possible values of intensity in relation to the applied voltage.

Maximum Voltage

The maximum voltage on the contacts depends on the insulation between each contact (pole-to-pole) and between all contacts and the coil.

The EN 60947 and VDE 0110 standards set out the maximum voltage values, taking into consideration the quality of the insulation materials, pollution degree as well as the shape and dimensions of the contact barriers (creepage distance).

Contacts in Series

The connection of two or more contacts in series is equivalent to multiplying the contact gap by that amount. By using this method, a greater break capacity is achieved for DC switching.

Minimum Working Voltage (pull in)

This is the minimum voltage that must be supplied to the coil to ensure that the relay energizes, the contacts change over and are positively held in place without any vibration.

The values of voltage specified are those at or below which the relay must pull in.

Working at:

AC 50 Hz Relays
AC 60 Hz Relays
DC Relays

50 Hz	60 Hz
0.8xU _n	0.85xU _n
0.75xU _n	0.8xU _n

$$0.8 \times U_n$$

Maximum Release Voltage (drop out)

This is the voltage at which the relay de-energizes, the contacts change over and are positively held in place without any vibration.

The values of voltage specified are those at or above which the relay must drop out.

DC relays ≤10% U_n

AC relays ≤20% U_n

Contacts in Parallel

The connection of two or more contacts in parallel does not mean that it is possible to switch a greater load. However, the stable current and the operational reliability of the relay is increased.

Double Make Contacts

The double make contact arrangement is equivalent to two contacts connected in series.

The maximum intensity supported corresponds to only one contact. This system allows for higher DC operating voltages.

Bifurcated (Twin) Contacts

The contact blade is divided into two parts, each with its own contact. Both contacts press down on their own independent fixed contacts.

This system is particularly good for switching at very low levels of current.

Contact Protection

The electrical life of contacts can be prolonged by components which eliminate or reduce the back EMF transients. These voltages are generated by the reactive component of the load on disconnection, which increases the duration and the temperature of the arc.

For AC, RC suppressors or varistors can be connected in parallel with the load or the contacts.

For DC with an inductive load, the best method is to connect a diode in parallel with the load.

Ambient Temperature

The ambient temperature has an influence on the coil resistance and on its thermal dissipation capacity.

Curve 1 represents the variations of the pull in voltage (%U_n) in relation with the ambient temperature (T).

Curve 2 indicates the maximum values of the voltage applied (U_b) to the coil in relation with the nominal voltage (U_n) at the ambient temperature (T).

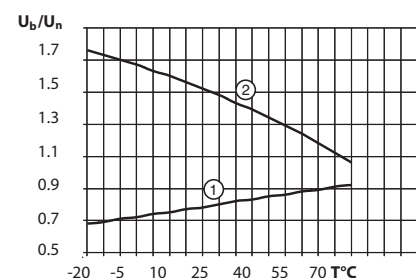

Relay Types Based on Applications

A General Purpose Relays

These are used for most general applications, such as automation, pneumatic, heating appliances, signaling, as an input or output interface, etc.

Change-over contacts. Isolation between N.O./N.C.: 1000 V_{rms}

Gap: 0.5 mm

Rating loads of up to:

- 16 A @ 230 V AC1
- 16 A @ 30 V DC1
- 0.5 A @ 110 V DC1
- 0.2 A @ 220 V DC1

Relays with Twin Contacts

T These are used to switch low currents with high operational reliability.

Change-over contacts. Isolation between contacts N.O./N.C.: 1000 V_{rms}

Gap: 0.5 mm

Gold-flashed contact 0.2μ or plated with 10μ Au (optional).

Maximum load: 6 A @ 230 V AC1

Minimum load: 1 mA @ 5 V DC1

Sensitive Relays, 250 mW

One change-over contact

S Sensitive Relays, 500 mW

Two change-over contacts

E Sensitive Relays, 800 mW

Three change-over contacts

N DC relays adjusted to work at lower power, available in both MR-C and QR-C versions. Gold-flashed contacts 0.2μ or plated 10μ Au (optional).

Operational voltage range:

- S** relays: 0.8 - 2.5 U_n
- E** relays: 0.8 - 1.7 U_n
- N** relays: 0.8 - 1.4 U_n

G Relays with Open Contacts

An open contact arrangement allows an increase in the contact gap, increasing the DC "break capacity" without altering the AC performance.

Gap: 1.5 mm(QR-C types);
1.7 mm(MR-C)

Isolation of contacts NO: >2000 V_{rms}

Maximum load:

- 16 A @ 230 V AC1
- 1.2 A @ 110 V DC1
- 0.4 A @ 220 V DC1

X Double Make Relays

These relays are designed to switch high DC loads at voltages of 110 and 220 VDC.

If consists of one normally open contact with a gap > 3 mm so that the arc length is divided by two.

Isolation between contacts: >2000 V_{rms}

The max. DC load is shown in the tables.

X versions are available in MR-C and QR-C type housing.

W High Inrush Current Relay

Two open contacts, one of silver nickel and one of tungsten work in parallel but are physically displaced so that the tungsten contact makes and breaks the load. The silver contact is used for carrying the stable current.

This relay was designed to switch incandescent and fluorescent lamps, (with p.f corrected), and DC inductive loads.

Only available in **C7** type housing.

Maximum loads:

- 6 A @ 230 V AC5a/b (lamps)
- 10 A @ 230 V AC15
- 1.5 A @ 110 V DC1

M Relays with "Mag. Blow Out"

These versions are similar to X types, however they have an addition of a powerful magnet which "blows out" the arc generated when the contacts are opened, therefore quenching the arcing quickly and increasing the contact life.

They are able to switch DC loads of up to 10 A @ 222 V DC1 and 2 A @ 220 V DC13

Remanence Relays

R A high remanence magnetic circuit allows the relay to latch positively when the current applied flows through the coil in a direction and detaches if the current flows in the opposite direction.

Electronic circuitry is added inside the relay to control this action and also protects against transient voltages.

There is one winding for AC coils and two windings for DC coils.

All coils withstand permanent connection.

The relay can be operated with pulses of 50 ms, minimum, at nominal voltage.

Specifications

The data referred to in the specifications for each model refers to typical values of "new" relays at 20°C.

Tables

The tables of electrical life and the tables of maximum DC current show the typical result of exhaustive tests performed at an ambient temperature of 20°C, operating frequency of 1,200 operations/hour, and under permanent connection.

The switching current ratings specified in the catalog refer to a minimum electrical life of 100,000 operations.

Margin of Over-Voltage

Coils withstand, on permanent connection, a maximum over-voltage of 110 percent U_n, with rated current through the contacts at an ambient temperature of 60°C.

Custom Relays

Relays with special specifications can be supplied after consultation with an official RELECO distributor.

Coil Accessories

MRC - QRC

Protection Against Transients

When the coil is disconnected from an electromagnet, peaks of inverse voltage appear at the terminals which can reach very high values. These pulses can be transmitted down the line associated with the coil and could possibly affect other components.

In the case of a relay being operated by such devices as transistors, triacs, etc; it may be necessary to protect against transients.

Transients Carried in the Line

High voltage surges can be carried in the supply line to the relay coil. These may appear in the form of peaks or bursts and are generated by the connection and disconnection of electric motors, transformers, capacitors, etc.

Normally a relay is unaffected by these pulses, but if a diode is connected in association with the coil, it must be capable of withstanding an inverse voltage higher than those of the incoming peaks.

X LED indication with rectifier.
For DC and AC relays up to 250 V
Surges of 1000 V up to 24 V
Surges of 2000 V from 25 to 60 V
Surges of 4000 V from 61 to 250 V

Note: LED connected in series with the coil @ 220 VDC in QRC types.

D Free-wheeling diode.

DX Free-wheeling diode + LED
Dampens transients caused by the relay coil on de-energization.
Surges of 2000 V up to 60 VDC
Surges of 4000 V from 61 to 250 VDC (*)

F Polarity and free wheeling diodes.

FX Polarity + free wheeling diode + LED
A diode in series with the coil protects the relay from reverse connection.
Surges of 1000 V up to 60 VDC
Surges of 4000 V from 61 to 250 VDC (*)

B Bridge rectifier incorporated.

BX Bridge rectifier + LED indication.
Allows the relay to operate in both AC or DC without any polarity inconvenience.
Available only in voltages up to 60 V
Surges of 1000 V

R Resistor and capacitor.
Suppressor for AC coils.
Surges of 2000 V
Available only in MRC types

(*) Surges of 2000 V in QRC types.

IRC

LED and protection circuit connected to coil.

X LED with no polarity, (standard)
Coils ≤ 12 V CC and CA
LED rectifier bridge in parallel

X LED with no polarity, (standard)
Coils ≥ 24 V CC and CA
LED rectifier bridge in series

FX LED with polarity A1+ (option)
Every DC coil voltage
Polarity and Free-wheeling diodes

BX LED with no polarity, (option)
Only 24 V and 48 V AC/DC coils
Rectifier bridge for AC/DC relays

R LED not available (option)
Every AC coil voltage
RC protection against pulses on AC

Protection Against Pulses

When a relay coil is disconnected, reverse voltage peaks may arise and reach very high values. Said peaks can transmit to the coil associated line and other relays or semiconductors can be affected.

If triac, transistor, etc. controls a relay, appropriate steps must be taken to avoid or decrease peaks down to a non-risky level.

Both polarity and free-wheeling diodes (FX), must protect coils, to avoid malfunctions, provided DC relays in battery are installed.

Making or breaking engines, transformers or contactors in an industrial environmental, may generate high voltage pulses, either isolated or burst, through the main line.

The voltage level of those pulse may be high enough to affect the isolation of the coil.

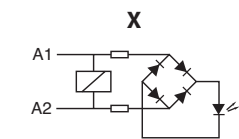

LED consumption: 1 mA

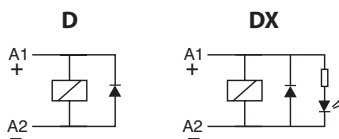

Increases release time approx. 4 times

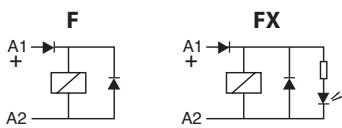

Increases release time approx. 4 times

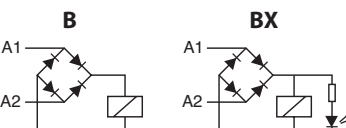

Increases release time approx. 3 times

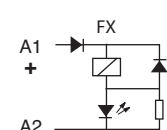
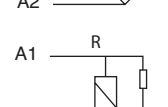
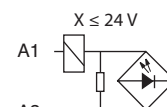
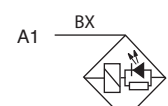
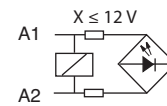
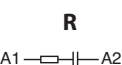

RELAYS

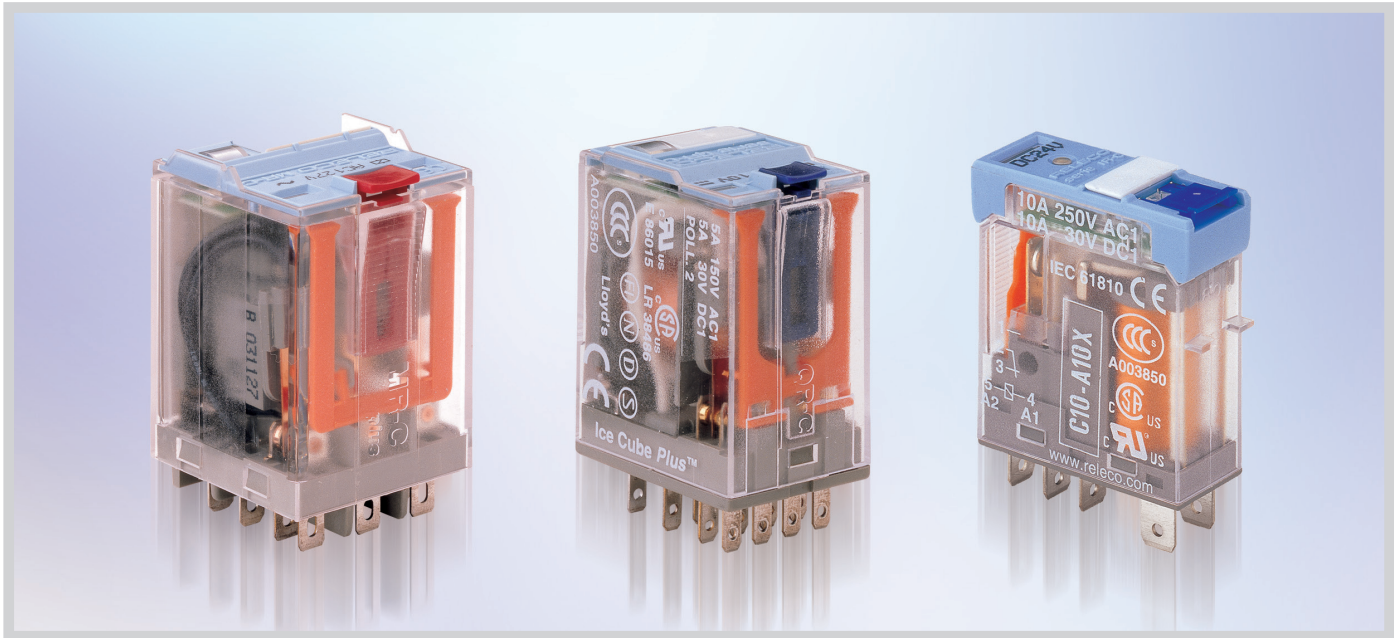

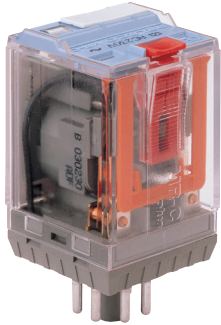

Relay compatible with sockets:
S2-B, S2-L, S2-PO

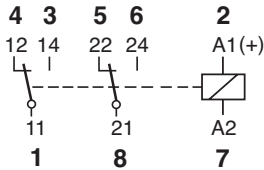

Table 1 Electrical Life, ops. x 10⁶

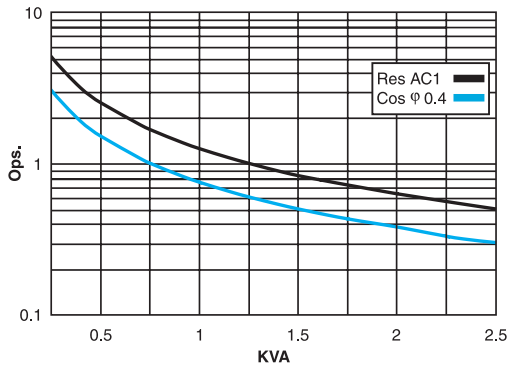
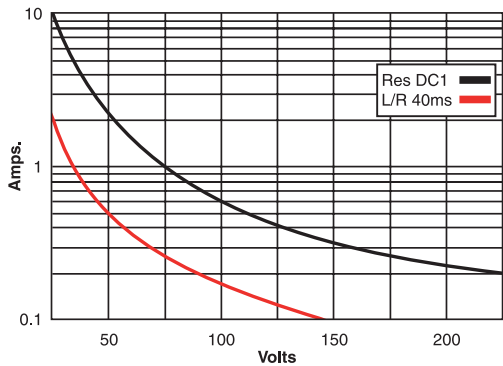
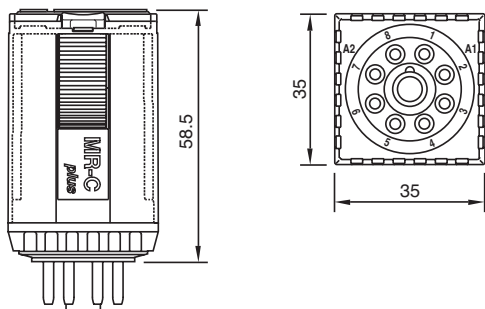

Table 2 Max. DC Load



Dimensions - mm



C2-A20



General purpose
Two pole, change-over contacts

10 A 250 V AC1 0.5 A 110 V DC1
10 A 30 V DC1 0.2 A 220 V DC1

Contacts

Materials: Standard, code 0 AgNi
Optional, code 8 AgNi + 5µ Au
Optional, code 9 AgNi + 0.2µ Au
Max. switching current 10 A
Max. peak inrush current (20 ms) 30 A
Max. switching voltage 250 V
Max. AC load (Table 1) 2.5 KVA
Max. DC load (Table 2)

Coils (Ohms ±10% @ 20°C)

Pull-in voltage ≤0.8 x U_n
Drop-out voltage ≥0.1 x U_n
Nominal coil power 2.2 VA (AC)/1.3 W (DC)

VAC	Ω	mA	VDC	Ω	mA
24	67	92	24	433	54
48	296	46	48	1K8	27
115	1K7	19	110	9K2	12
230	7K1	9.5	220	36K1	6

Insulation

Dielectric strength (1 minute): Open contacts 1,000 V
Between adjacent poles 2.5 KV
Between contacts and coil 2.5 KV
Insulation resistance at 500 V ≥1 GΩ
Insulation, IEC 61810-5: 2.5 KV/3

Specifications

Operate time + bounce time 16 ms
Release time + bounce time 8 ms
Ambient temperature -40°C (no ice) to +60°C
Mechanical life ops. 10 Mill. AC, 20 Mill. DC relay
Electrical life at nominal load ≥100,000 ops.
Operating frequency at nominal load 1,200/hour
Protection degree IP 40/RT1
Weight avg. 90 g

Standard Types

AC 50 Hz, (60 Hz): 24, 48, 115, (120), 230, (240)
X = LED (standard) **C2-A20X VAC**
RC suppressor **C2-A20R..... VAC**
DC 24, 48, 110, 220
X = LED, no polarity (standard) **C2-A20X VDC**
Free-wheeling diode **C2-A20DX VDC**
Polarity and free-wheeling diodes **C2-A20FX VDC**
AC/DC bridge rectifier (24, 48 or 60 V) **C2-A20BX UC**

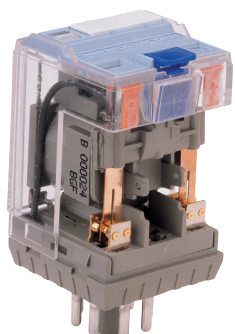

Relay compatible with sockets:
S2-B, S2-L, S2-PO

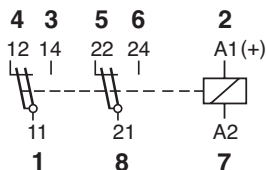

C2-T21



Low level
Two change-over bifurcated contacts

6 A 250 V AC1 6 A 30 V DC1
Min. contacts load: 1 mA / 5 V DC1

Contacts

Materials:	Standard, code 1	AgNi + 0.3µAu
	Optional, code 2	AgNi + 5µAu
Max. switching current		6 A
Max. peak inrush current (20 ms)		15 A
Max. switching voltage		250 V
Max. AC load (Table 1)		1.2 KVA
Max. DC load (Table 2)		

Coils (Ohms ±10% @ 20°C)

Pull-in voltage	≤0.8 x U _n
Drop-out voltage	≥0.1 x U _n
Nominal coil power	2.2 VA (AC)/1.3 W (DC)

VAC	Ω	mA	VDC	Ω	mA
24	67	92	24	433	54
48	296	46	48	1K8	27
115	1K7	19	110	9K2	12
230	7K1	9.5	220	36K1	6

Table 1 Electrical Life, ops. x 10⁶

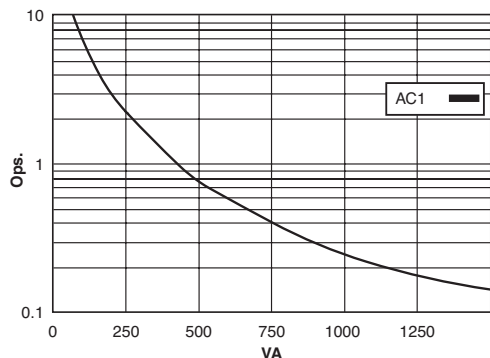
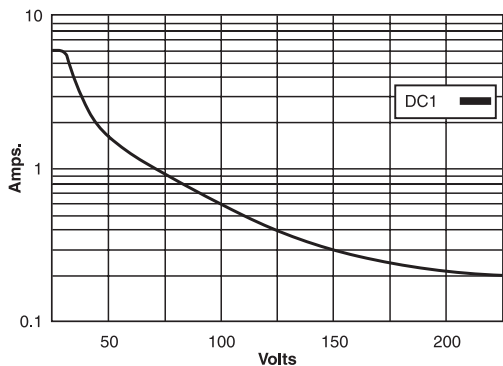
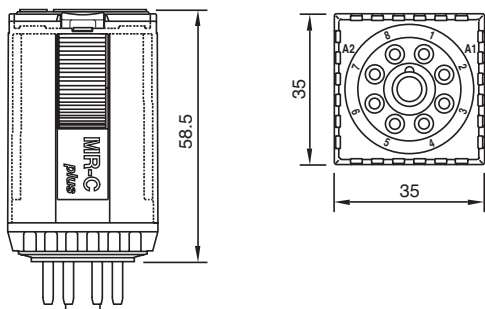

Table 2 Max. DC Load



Dimensions - mm



Insulation

Dielectric strength (1 minute): Open contacts	1,000 V
Between adjacent poles	2.5 KV
Between contacts and coil	2.5 KV
Insulation resistance at 500 V	≥1 GΩ
Insulation, IEC 61810-1:	2.5 KV/3

Specifications

Operate time + bounce time	16 ms
Release time + bounce time	8 ms
Ambient temperature	-40°C (no ice) to +60°C
Mechanical life ops.	10 Mill. AC, 20 Mill. DC relay
Electrical life at nominal load	100,000 ops.
Operating frequency at nominal load	1,200/hour
Protection degree	IP 40/RT1
Weight avg.	90 g

Standard Types

AC 50 Hz, (60 Hz): 24, 48, 115, (120), 230, (240)	
X = LED (standard)	C2-T21X VAC
RC suppressor	C2-T21R VAC
DC 24, 48, 110, 220	
X = LED, no polarity (standard)	C2-T21X VDC
Free-wheeling diode	C2-T21DX VDC
Polarity and free-wheeling diodes	C2-T21FX VDC
AC/DC bridge rectifier (24, 48 or 60 V)	C2-T21BX UC



IEC 61810 EN 60947



Relay compatible with sockets:
S2-B, S2-L, S2-PO

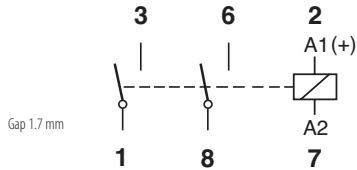

Table 1 Electrical Life, ops. x 10⁶

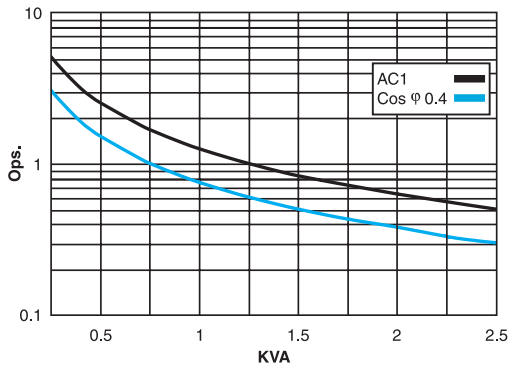
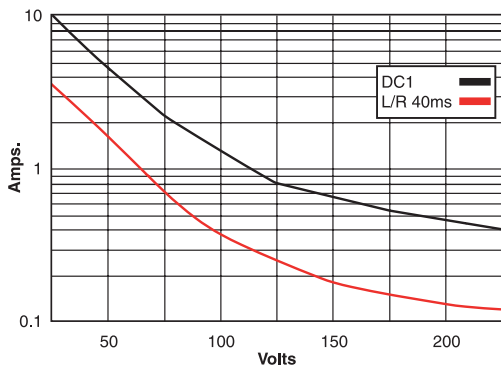
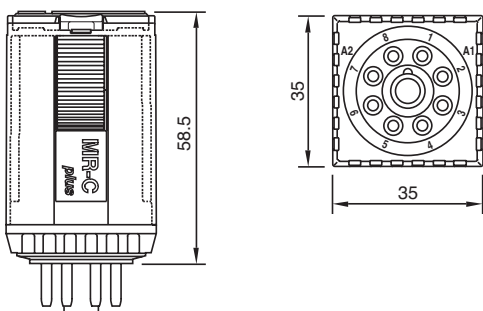

Table 2 Max. DC Load



Dimensions - mm



C2-G20



General purpose, DC applications
Two pole open contacts

10 A 250 V AC1 1.2 A 110 V DC1
10 A 30 V DC1 0.4 A 220 V DC1

Contacts

Materials: Standard, code 0 AgNi
Max. switching current 10 A
Max. peak inrush current (20 ms) 30 A
Max. switching voltage 250 V
Max. AC load (Table 1) 2.5 KVA
Max. DC load (Table 2)

Coils (Ohms ±10% @ 20°C)

Pull-in voltage ≤0.8 x U_n
Drop-out voltage ≥0.1 x U_n
Nominal coil power 2.4 VA (AC)/1.6 W (DC)

VAC	Ω	mA	VDC	Ω	mA
24	65	100	24	360	66
48	286	50	48	1K4	34
115	1K7	21	110	7K6	15
230	6K8	10	220	30K3	7.5

Insulation

Dielectric strength (1 minute): Open contacts 2,000 V
Between adjacent poles 2.5 KV
Between contacts and coil 2.5 KV
Insulation resistance at 500 V ≥1 GΩ
Insulation, EN 61810-1: 2.5 KV / 3

Specifications

Operate time + bounce time 20 ms
Release time + bounce time 10 ms
Ambient temperature -40°C (no ice) to +60°C
Mechanical life ops. 10 Mill. AC, 20 Mill. DC relays
Electrical life at nominal load ≥100,000 ops.
Operating frequency at nominal load 1,200/hour
Protection degree IP 40/RT1
Weight avg. 90 g

Standard Types

AC 50 Hz, (60 Hz): 24, 48, 115, (120), 230, (240)
X = LED (standard) C2-G20X VAC
RC suppressor C2-G20R VAC

DC 24, 48, 110, 220
X = LED, no polarity (standard) C2-G20X VDC
Free-wheeling diode C2-G20DX VDC
Polarity and free-wheeling diodes C2-G20FX VDC
AC/DC bridge rectifier (24, 48 or 60V) C2-G20BX UC



IEC 61810 EN 60947



Relay compatible with sockets:
S3-B, S3-S, S3-L, S3-PO

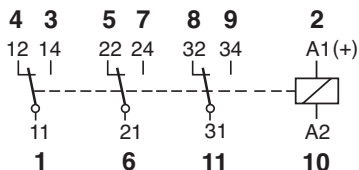

C3-A30



General purpose
Three pole, change-over contacts

10 A 250 V AC1 0.5 A 110 V DC1
10 A 30 V DC1 0.5 A 220 V DC1

Contacts

Materials:	Standard, code 0	AgNi
	Optional, code 8	AgNi + 5μ Au
	Optional, code 9	AgNi + 0.2μ Au
Max. switching current		10 A
Max. peak inrush current (20 ms)		30 A
Max. switching voltage		250 V
Max. AC load (Table 1)		2.5 KVA
Max. DC load (Table 2)		

Coils (Ohms ±10% @ 20°C)

Pull-in voltage	≤0.8 x U _n
Drop-out voltage	≥0.1 x U _n
Nominal coil power	2.2 VA (AC)/1.3 W (DC)

VAC	Ω	mA	VDC	Ω	mA
24	67	92	24	433	54
48	296	46	48	1K8	27
115	1K7	19	110	9K2	12
230	7K1	9.5	220	36K1	6

Table 1 Electrical Life, ops. x 10⁶

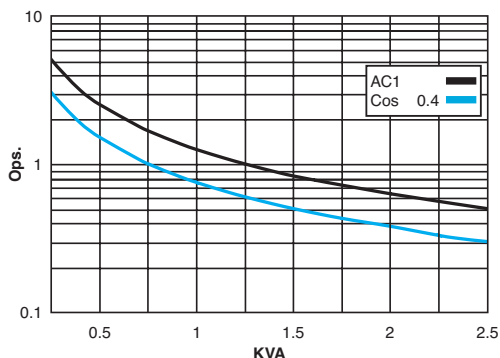
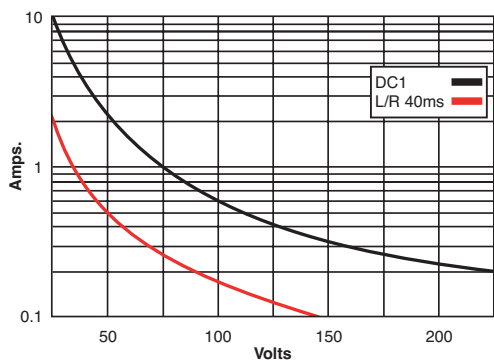
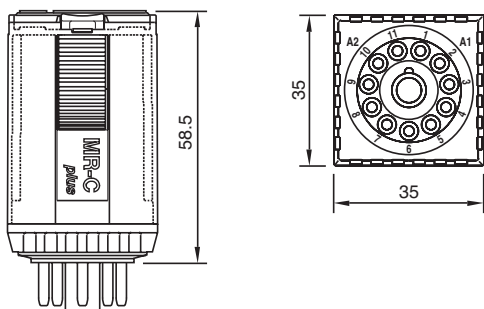

Table 2 Max. DC Load



Dimensions - mm



Insulation

Dielectric strength (1 minute): Open contacts	1,000 V
Between adjacent poles	2.5 KV
Between contacts and coil	2.5 KV
Insulation resistance at 500 V	≥1 GΩ
Insulation, IEC 61810-1:	2.5 KV/3

Specifications

Operate time + bounce time	16 ms
Release time + bounce time	8 ms
Ambient temperature	-40°C (no ice) to +60°C
Mechanical life ops.	10 Mill. AC, 20 Mill. DC relays
Electrical life at nominal load	100,000 ops.
Operating frequency at nominal load	1,200/hour
Protection degree	IP 40/RT1
Weight avg.	90 g

Standard Types

AC 50 Hz, (60 Hz): 24, 48, 115, (120), 230, (240)	
X = LED (standard)	C3-A30X VAC
RC suppressor	C3-A30R..... VAC
DC 24, 48, 110, 220	
X = LED, no polarity (standard)	C3-A30XVDC
Free-wheeling diode	C3-A30DX.....VDC
Polarity and free-wheeling diodes	C3-A30FXVDC
AC/DC bridge rectifier (24, 48 or 60 V)	C3-A30BX UC

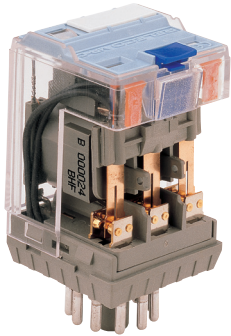

Relay compatible with sockets:
S3-B, S3-S, S3-L, S3-PO

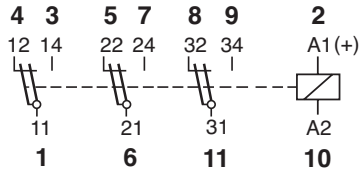

Table 1 Electrical Life, ops. x 10⁶

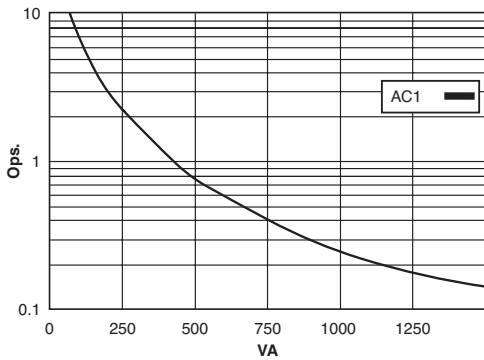
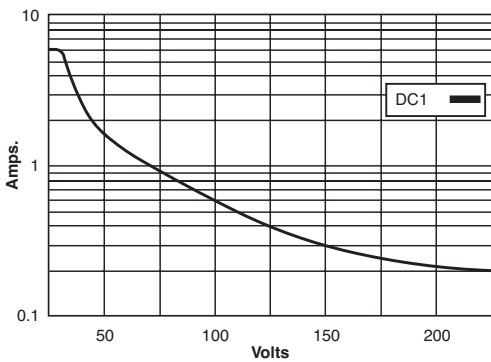
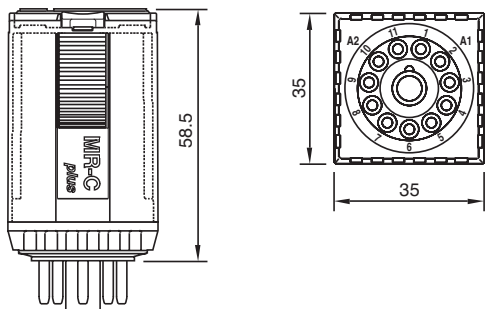

Table 2 Max. DC Load



Dimensions - mm



C3-T31



Low level
Three change-over bifurcated contacts

6 A 250 V AC1 6 A 30 V DC1
Min. contacts load: 1 mA / 5 V DC1

Contacts

Materials: Standard, code 1 AgNi + 0.3µAu
Optional, code 2 AgNi + 5µAu
Max. switching current 6 A
Max. peak inrush current (15 ms) 15 A
Max. switching voltage 250 V
Max. AC load (Table 1) 1.2 KVA
Max. DC load (Table 2)

Coils (Ohms ±10% @ 20°C)

Pull-in voltage ≤0.8 x U_N
Drop-out voltage ≥0.1 x U_N
Nominal coil power 2.2 VA (AC)/1.3 W (DC)

VAC	Ω	mA	VDC	Ω	mA
24	67	92	24	443	54
48	296	46	48	1K8	27
115	1K7	19	110	9K2	12
230	7K1	9.5	220	36K1	6

Insulation

Dielectric strength (1 minute): Open contacts 1,000 V
Between adjacent poles 2.5 KV
Between contacts and coil 2.5 KV
Insulation resistance at 500 V ≥1 GΩ
Insulation, IEC 61810-1: 2.5 KV / 3

Specifications

Operate time + bounce time 16 ms
Release time + bounce time 8 ms
Ambient temperature -40°C (no ice) to +60°C
Mechanical life ops. 10 Mill. AC, 20 Mill. DC relays
Electrical life at nominal load ≥100,000 ops.
Operating frequency at nominal load 1,200/hour
Protection degree IP 40/RT1
Weight avg. 90 g

Standard Types

AC 50 Hz, (60 Hz): 24, 48, 115, (120), 230, (240)
X = LED (standard) **C3-T31X** VAC
RC suppressor **C3-T31R** VAC
DC 24, 48, 110, 220
X = LED, no polarity (standard) **C3-T31X** VDC
Free-wheeling diode **C3-T31DX** VDC
Polarity and free-wheeling diodes **C3-T31FX** VDC
AC/DC bridge rectifier (24, 48 or 60V) **C3-T31BX.....** UC



IEC 61810 EN 60947

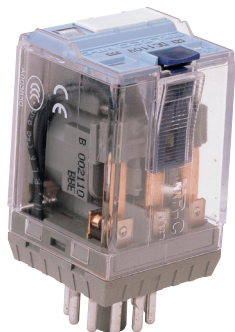

Relay compatible with sockets:
S3-B, S3-S, S3-L, S3-PO

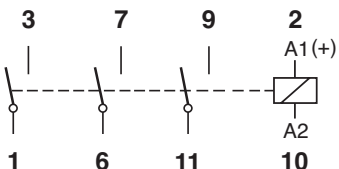

Gap 1.7 mm

Table 1 Electrical Life, ops. x 10⁶

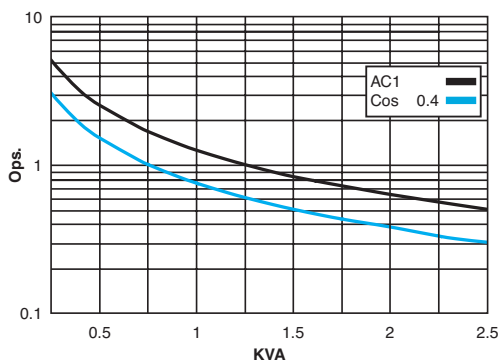
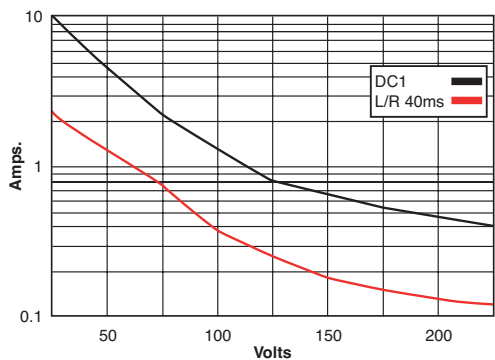
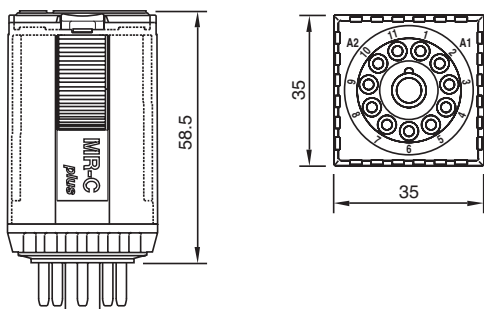

Table 2 Max. DC Load



Dimensions - mm



C3-G30



General purpose, DC applications
Three pole, open contacts

10 A 250 V AC1 1.2 A 110 V DC1
10 A 30 V DC1 0.4 A 220 V DC1

Contacts

Materials: Standard, code 0 AgNi
 Max. switching current 10 A
 Max. peak inrush current (20 ms) 30 A
 Max. switching voltage 250 V
 Max. AC load (Table 1) 2.5 KVA
 Max. DC load (Table 2)

Coils (Ohms ±10% @ 20°C)

Pull-in voltage ≤0.8 x U_n
 Drop-out voltage ≥0.1 x U_n
 Nominal coil power 2.4 VA (AC)/1.6 W (DC)

VAC	Ω	mA	VDC	Ω	mA
24	65	100	24	360	66
48	286	50	48	1K4	34
115	1K7	21	110	7K6	15
230	6K8	10	220	30K3	7.5

Insulation

Dielectric strength (1 minute): Open contacts 2,000 V
 Between adjacent poles 2.5 KV
 Between contacts and coil 2.5 KV
 Insulation resistance at 500 V ≥1 GΩ
 Insulation, IEC 61810-1: 2.5 KV/3

Specifications

Operate time + bounce time 20 ms
 Release time + bounce time 10 ms
 Ambient temperature -40°C (no ice) to +60°C
 Mechanical life ops. 10 Mill. AC, 20 Mill. DC relays
 Electrical life at nominal load ≥100,000 ops.
 Operating frequency at nominal load 1,200/hour
 Protection degree IP 40/RT1
 Weight avg. 90 g

Standard Types

AC 50 Hz, (60 Hz): 24, 48, 115, (120), 230, (240)
 X = LED (standard) **C3-G30X** VAC
 RC suppressor **C3-G30R** VAC

DC 24, 48, 110, 220
 X = LED, no polarity (standard) **C3-G30X** VDC
 Free-wheeling diode **C3-G30DX**..... VDC
 Polarity and free-wheeling diodes **C3-G30FX** VDC
 AC/DC bridge rectifier (24, 48 or 60 V) **C3-G30BX**..... UC



IEC 61810 EN 60947

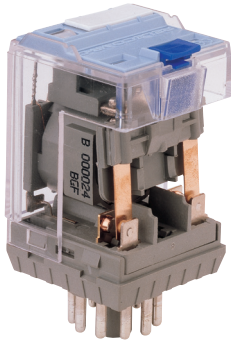

Relay compatible with sockets:
S3-B, S3-S, S3-L, S3-PO

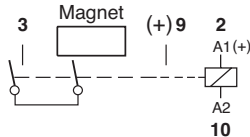

Gap > 3 mm (1.7+1.7)

Table 1 Electrical Life, ops. x 10⁶

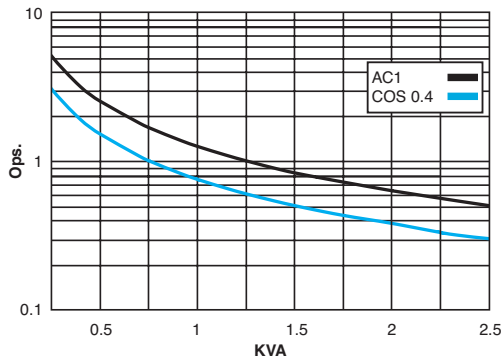
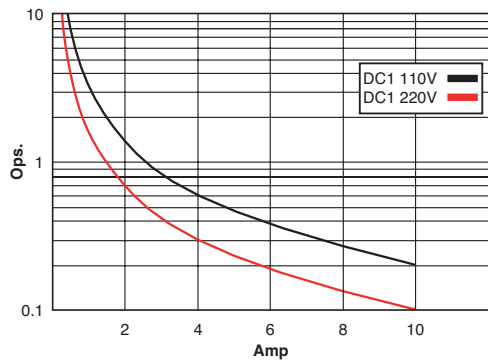
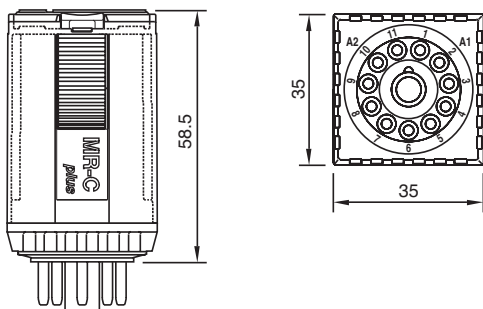

Table 2 DC Voltage Endurance



Dimensions - mm



C3-M10



Power relay, DC
Single pole, magnetic blow out

10 A 250 V AC1 10 A 220 V DC1
3.6 A 110 V DC1 2 A 220 V DC1

Contacts

Materials: Standard, code 0 AgNi
Max. switching current 10 A
Max. peak inrush current (20 ms) 30 A
Max. switching voltage (pollution 3) 250 V
Max. switching voltage (pollution 2) 250 V
Max. AC load (Table 1) 2.5 KVA
Max. DC load (Table 2)

Coils (Ohms ±10% @ 20°C)

Pull-in voltage ≤0.8 x U_n
Drop-out voltage ≥0.1 x U_n
Nominal coil power 2.4 VA (AC)/1.3 W (DC)

VAC	Ω	mA	VDC	Ω	mA
24	65	100	24	443	54
48	286	50	48	1K7	27
115	1K7	21	110	9K2	12
230	6K8	10	220	36K1	6

Insulation

Dielectric strength (1 minute):
Open contacts 2.5 KV
Between contacts and coil 2.5 KV
Insulation resistance at 500 V ≥1 GΩ
Insulation, IEC 61810-1: 2.5 KV / 3

Specifications

Nominal coil power 2.4 VA (AC), 1.3 W (DC)
Operate time 20 ms
Release time 10 ms
Isolation: EN60947 pollution 3, Gr C 250 V
Dielectric strength, contacts/coils 2.5 KV

Standard Types (50/60 Hz and DC)

AC 24, 48, 115, (120), 230
X = LED (standard) **C3-M10X..... VAC**
RC suppressor **C3-M10R..... VAC**

DC 24, 48, 110, 220
X = LED, no polarity (standard) **C3-M10X..... VDC**
Free-wheeling diode **C3-M10DX..... VDC**
Polarity and free-wheeling diodes **C3-M10FX..... VDC**
AC/DC bridge rectifier (24, 48 or 60V) **C3-X10BX..... UC**



IEC 61810 EN 60947

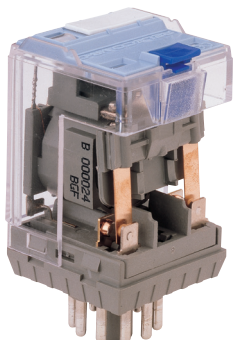

Relay compatible with sockets:
S3-B, S3-S, S3-L, S3-PO

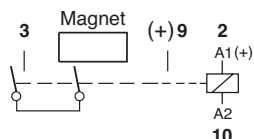

Gap > 3 mm (1.7+1.7)

C3-X10



Power relay for DC applications
Single pole, N.O., double make

10 A 250 V AC1 7 A 110 V DC1
10 A 30 V DC1 1.2 A 220 V DC1

Contacts

Materials:	Standard, code 0	AgNi
Max. switching current		10 A
Max. peak inrush current (20 ms)		30 A
Max. switching voltage		250 V
Max. AC load (Table 1)		2.5 KVA
Max. DC load (Table 2)		

Coils (Ohms ±10% @ 20°C)

Pull-in voltage	≤0.8 x U _n
Drop-out voltage	≥0.1 x U _n
Nominal coil power	2.4 VA (AC)/1.3 W (DC)

VAC	Ω	mA	VDC	Ω	mA
24	65	100	24	443	54
48	286	50	48	1K7	27
115	1K7	21	110	9K2	12
230	6K8	10	220	36K1	6

Table 1 Electrical Life, ops. x 10⁶

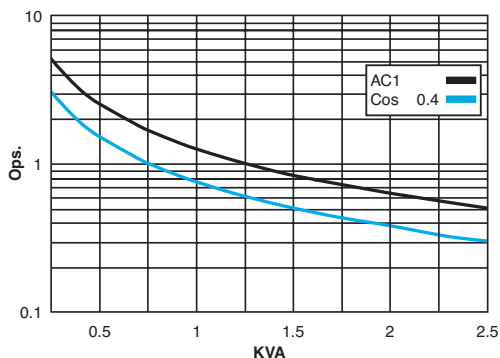
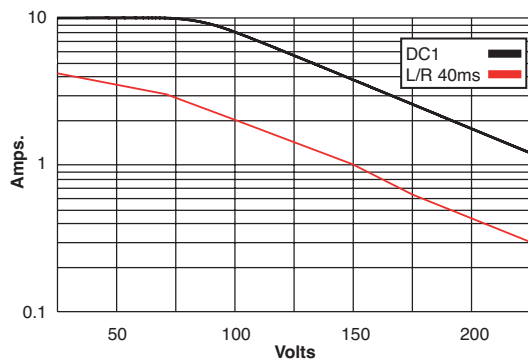
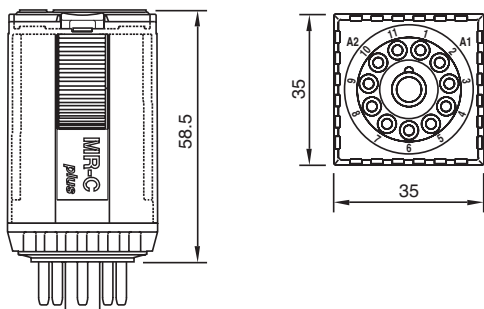

Table 2 Max. DC Load



Dimensions - mm



Insulation

Dielectric strength (1 minute):		
Open contacts		2.5 KV
Between contacts and coil		2.5 KV
Insulation resistance at 500 V		≥1 GΩ
Insulation, IEC 61810-1:		2.5 KV / 3

Specifications

Operate time + bounce time	20 ms
Release time + bounce time	10 ms
Ambient temperature	-40°C (no ice) to +70°C
Mechanical life ops.	10 Mill. AC, 20 Mill. DC relays
Electrical life at nominal load	≥100,000 ops.
Operating frequency at nominal load	1,200/hour
Protection degree	IP40 / RT1
Weight avg.	90 g

Standard Types

AC 50 Hz, (60 Hz): 24, 48, 115, (120), 230, (240)
X = LED (standard) **C3-X10X..... VAC**
RC suppressor **C3-X10R..... VAC**

DC 24, 48, 110, 220
X = LED, no polarity (standard) **C3-X10X..... VDC**
Free-wheeling diode **C3-X10DX VDC**
Polarity and free-wheeling diodes **C3-X10FX..... VDC**
AC/DC bridge rectifier (24, 48 or 60 V) **C3-X10BX UC**



IEC 61810 EN 60947

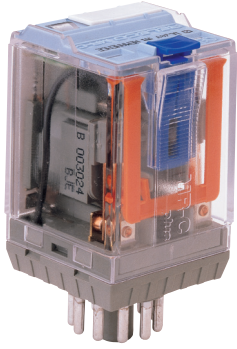

Relay compatible with sockets:
S3-B, S3-S, S3-L, S3-PO

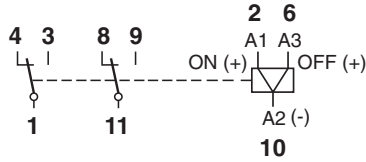

Table 1 Electrical Life, ops. x 10⁶

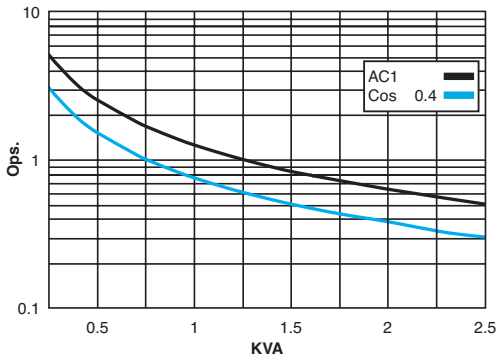
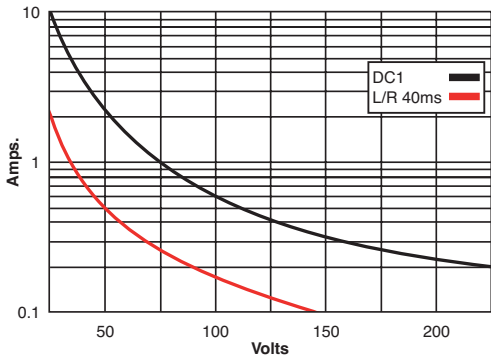
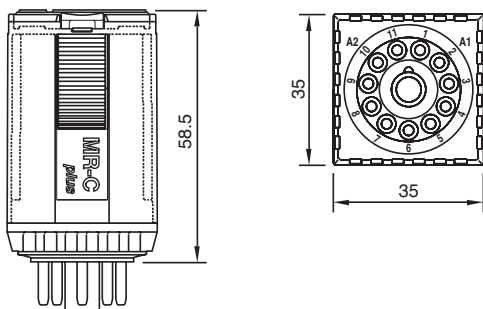

Table 2 Max. DC Load



Dimensions - mm



C3-R20



Magnetic latching
Two change-over contacts

10 A 250 V AC1 0.5 A 110 V DC1
10 A 30 V DC1 0.2 A 220 V DC1

Contacts

Materials: Standard, code 0 AgNi
Optional, code 8 AgNi + 5µ Au
Optional, code 9 AgNi + 0.2µ Au

Max. switching current 10 A
Max. peak inrush current (20 ms) 30 A
Max. switching voltage 250 V
Max. AC load (Table 1) 2.5 KVA
Max. DC load (Table 2)

Coils

ON pulse power 1.5 VA / W
OFF pulse power 0.5 VA / W
One winding for AC. Two winding for DC

VAC	ON mA	OFF mA	VDC	ON mA	OFF mA
24	75	12	12	125	41
48	38	6	24	63	21
115	16	2.5	48	31	10
230	8	1.3	110	14	4.5

Insulation

Dielectric strength (1 minute): Open contacts 1,000 V
Between adjacent poles 2.5 KV
Between contacts and coil 2.5 KV
Insulation resistance at 500 V ≥ 1 GΩ
Insulation, IEC 61810-1: 2.5 KV / 3

Specifications

Minimum pulse length for ON / OFF 50 ms
Ambient temperature -40°C (no ice) to +60°C
Mechanical life ops. 10 Mill. AC, 20 Mill. DC relays
Electrical life at nominal load ≥ 100,000 ops.
Operating frequency at nominal load 1,200/hour
Protection degree IP 40/RT1
Weight avg. 95 g

Standard Types

AC 50 Hz, (60 Hz): 24, 48, 115, (120), 230, (240)
C3-R20..... VAC

DC 12, 24, 48, 110
C3-R20..... VDC

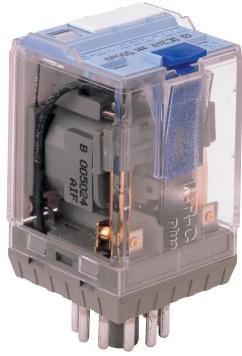

Relay compatible with sockets:
S3-B, S3-S, S3-L, S3-PO

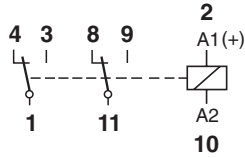

C3-E24



Sensible, 500 mW
Two change-over contacts, 6 A
Operating range: 0.8-1.7 x U_n

6 A 250 V AC1 6 A 30 V DC1

Contacts

Materials:	Standard, code 4	AgNi + 0.2μ Au
	Optional, code 8	AgNi + 10μ Au
Max. switching current		6 A
Max. peak inrush current (20 ms)		15 A
Max. switching voltage		250 V
Max. AC load (Table 1)		1.5 KVA
Max. DC load (Table 2)		

Coils (Ohms ±10% @ 20°C)

Pull-in voltage	≤0.8 x U _n
Drop-out voltage	≥0.1 x U _n
Nominal coil power	500 mW

VDC	Ω	mA
24	1K1	21
48	4K6	10
60	7K2	8.3
110	24K2	4.5

Table 1 Electrical Life, ops. x 10⁶

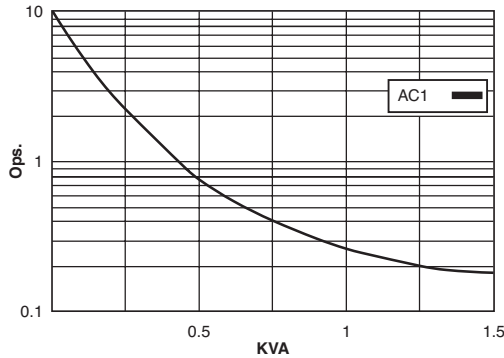
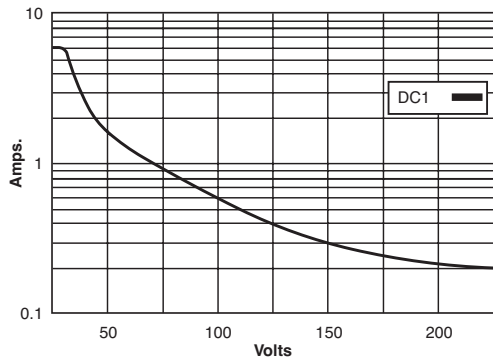
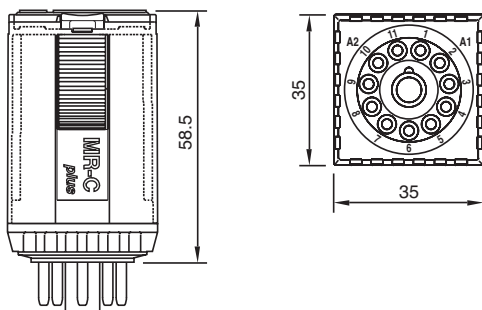

Table 2 Max. DC Load



Dimensions - mm



Insulation

Dielectric strength (1 minute): Open contacts	1,000 V
Between adjacent poles	2.5 KV
Between contacts and coil	2.5 KV
Insulation resistance at 500 V	≥1 GΩ
Insulation, IEC 61810-1:	2.5 KV/3

Specifications

Operate time + bounce time	18 ms
Release time + bounce time	10 ms
Ambient temperature	-40°C (no ice) to +60°C
Mechanical life ops.	10 Mill. AC, 20 Mill. DC relays
Electrical life at nominal load	≥100,000 ops.
Operating frequency at nominal load	1,200/hour
Protection degree	IP 40/RT1
Weight avg.	90 g

Standard Types

DC 12, 24, 48, 60, 110	C3-E24VDC
Free-wheeling diode	C3-E24D.....VDC
Polarity and free-wheeling diodes	C3-E24FVDC

Connecting diodes to the coil will increase the release time.
LED available upon request.



Relay compatible with sockets:
S3-B, S3-S, S3-L, S3-PO

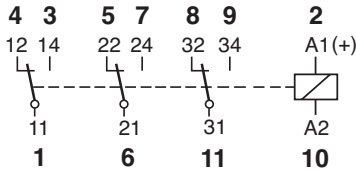

C3-N34



Sensitive, 800 mW
Three change-over contacts, 6 A
Operating range: 0.8-1.4 x U_N

6 A 250 V AC1 6 A 30 V DC1

Contacts

Materials:	Standard, code 4	AgNi + 0,2µ Au
	Optional, code 8	AgNi + 10µ Au
Max. switching current		6 A
Max. peak inrush current (20 ms)		15 A
Max. switching voltage		250 V
Max. AC load (Table 1)		1.5 KVA
Max. DC load (Table 2)		

Coils (Ohms ±10% @ 20°C)

Pull-in voltage	≤ 0.8 x U _n
Drop-out voltage	≥ 0.1 x U _n
Nominal coil power	800 mW

VDC	Ω	mA
24	720	33
48	2K8	17
60	4K5	13
110	15K	7

Table 1 Electrical Life, ops. x 10⁶

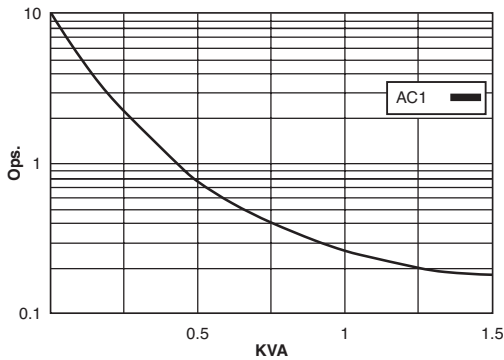
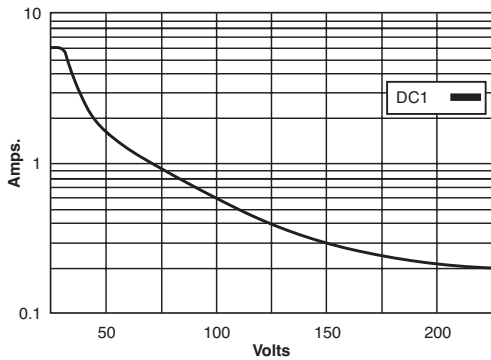

Table 2 Max. DC Load



Insulation

Dielectric strength (1 minute): Open contacts	1,000 V
Between adjacent poles	2.5 KV
Between contacts and coil	2.5 K
Insulation resistance at 500 V	≥ 3 GΩ
Insulation, IEC 61810-1:	2.5 KV / 3

Specifications

Operate time + bounce time	18 ms
Release time + bounce time	10 ms
Ambient temperature	-40°C (no ice) to +60°C
Mechanical life ops.	10 Mill. AC, 20 Mill. DC relays
Electrical life at nominal load	≥ 100,000 ops.
Operating frequency at nominal load	1,200/hour
Protection degree	IP 40/RT1
Weight avg.	90 g

Dimensions - mm

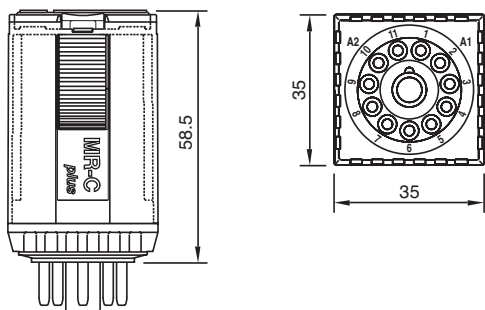

Standard Types

DC 24, 48, 60, 110	C3-N34..... VAC
Free-wheeling diode	C3-N34D..... VDC
Polarity and free-wheeling diodes	C3-N34F..... VDC

Connecting diodes to the coil will increase the release time.
LED available upon request.

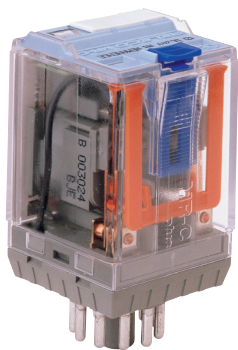

Relay compatible with sockets:
S3-B, S3-S, S3-L, S3-PO

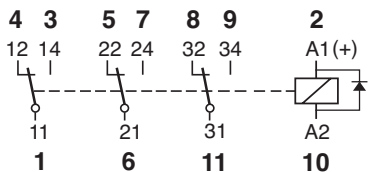

R3-N30D



Railway Application Relay
According to EN 60077-1-2/99
EN 61373/99

6 A 250 V AC1 6 A 30 V DC1

Contacts

Materials:	Standard, code 0	AgNi
	Optional, code 4	AgNi + 0.2μ Au
	Optional, code 8	AgNi + 10μ Au
Max. switching current		6 A
Max. peak inrush current (20 ms)		15 A
Max. switching voltage		250 V
Max. AC load (Table 1)		
Max. DC load (Table 2)		

Coils

Operation Range	0.7 U_n @ 1.25 U_n
Power Consumption	1.07 W
Generated transients	V, include FWD

Voltage	$\Omega \pm 10\%$	mA
24	525	46
48	2133	22
72	4844	15
110	12900	9

Table 1 Electrical Life, ops. x 10⁶

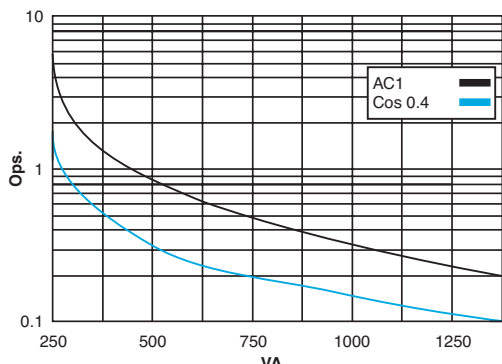
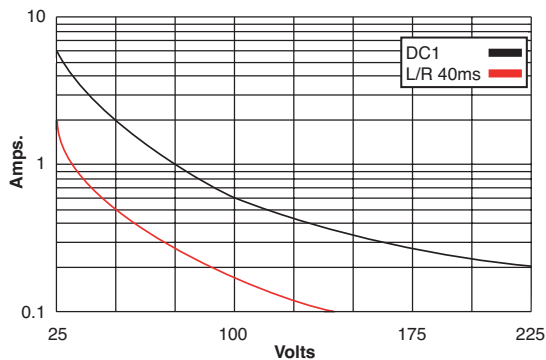
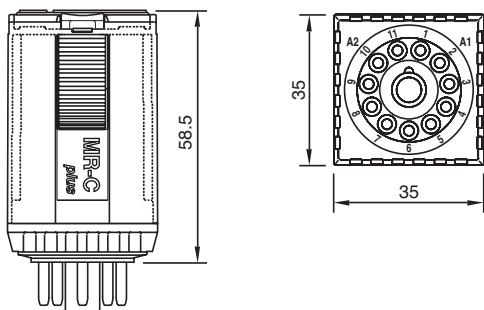

Table 2 Electrical Life, ops. x 10⁶



Dimensions - mm



Isolation

Polution grade	PD3
With voltage (1.2/50μs) / Dielectric strength (1 minute):	
Contact coil	4 KV/2220 V
Between different poles	4 KV/2220 V
Between contacts on same pole	1550 KV/850 V

Specifications

Max working temperature	40°C
Number of mechanical operations	>10 million
Thermic Class B (130°C)	
Vibration: Category/Class	1/B Body Mounted
Vibration	5-150 Hz (3 axes)
Shock	5 g (3 axes)
Operation (UN)/release time	18 ms/35 ms
Weight avg.	95 g
Weight avg. Relay + Socket	150 g
Relay Protection	IP 40

Standard Types

DC 24, 48, 72, 110	
X = LED	
Free-wheeling diode	R3-N30.....VDC
LED and free-wheeling diode	R3-N30X.....VDC
	R3-N30D.....VDC
	R3-N30DX.....VDC



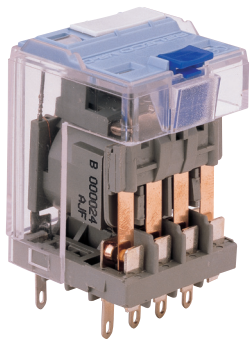

Relay compatible with sockets:

S4-B, S4-L, S4-P, S4-PO

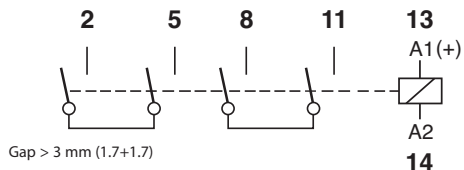

C4-X20



Power relay, DC applications
Two pole, N.O., double make

10 A 250 V AC1 7 A @ 110 V DC1
10 A 30 V DC1 1.2 A @ 220 V DC1

Contacts

Materials:	Standard, code 0	AgNi
Max. switching current		10 A
Max. peak inrush current (20 ms)		30 A
Max. switching voltage		250 V
Max. AC load (Table 1)		0.5 KVA
Max. DC load (Table 2)		

Coils (Ohms ±10% @ 20°)

Pull-in voltage	≤0.8 x U _n
Drop-out voltage	≥0.1 x U _n
Nominal coil power	2.4 VA (AC)/1.3 W (DC)

VAC	Ω	mA	VDC	Ω	mA
24	65	100	24	443	54
48	286	50	48	1K8	27
115	1K7	21	110	9K2	12
230	6K8	10	220	36K1	6

Table 1 Electrical Life, ops. x 10⁶

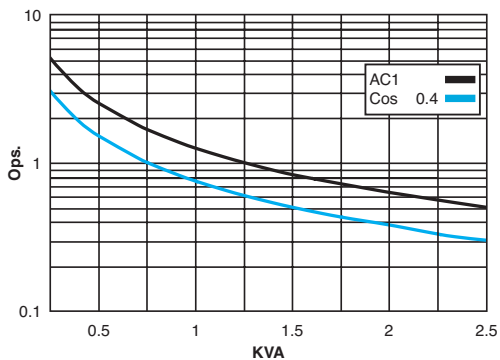
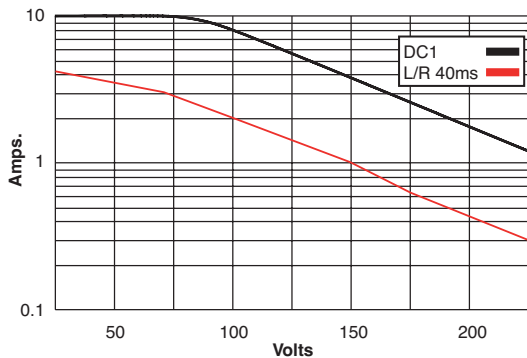
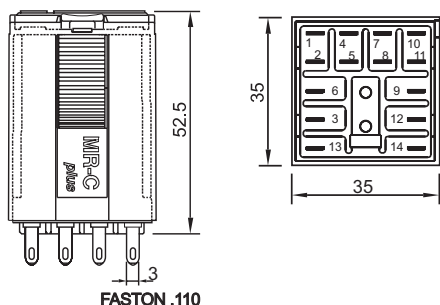

Table 2 Max. DC Load



Dimensions - mm



Insulation

Dielectric strength (1 minute): Open contacts	2,500 V
Between adjacent poles	2.5 KV
Between contacts and coil	2.5 KV
Insulation resistance at 500 V	≤1 GΩ
Insulation, IEC 61810-1:	2.5 KV/3

Specifications

Operate time + bounce time	20 ms
Release time + bounce time	8 ms
Ambient temperature	-40°C (no ice) to +60°C
Mechanical life ops.	10 Mill. AC, 20 Mill. DC relays
Electrical life at nominal load	≥100,000 ops.
Operating frequency at nominal load	1,200/hour
Protection degree	IP 40/RT1
Weight avg.	90 g

Standard Types

AC 50 Hz, (60 Hz): 24, 48, 115, (120), 230, (240)	
X = LED (standard)	C4-X20X..... VAC
RC suppressor	C4-X20R..... VAC
DC 24, 48, 110, 220	
X = LED no polarity (standard)	C4-X20X..... VDC
Free-wheeling diode	C4-X20DX VDC
Polarity and free-wheeling diodes	C4-X20FX..... VDC
AC/DC bridge rectifier (24, 48 or 60 V)	C4-X20BX UC

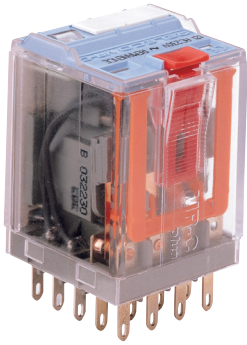

Relay compatible with sockets:
S4-B, S4-L, S4-P, S4-PO

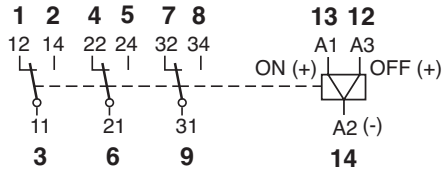

Table 1 Electrical Life, ops. x 10⁶

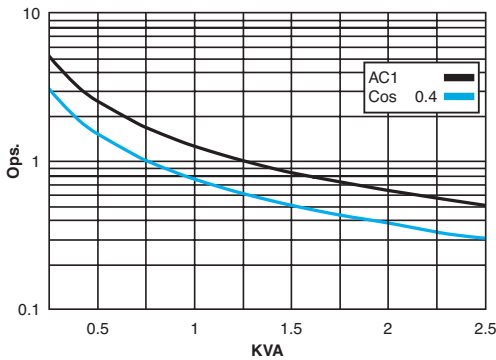
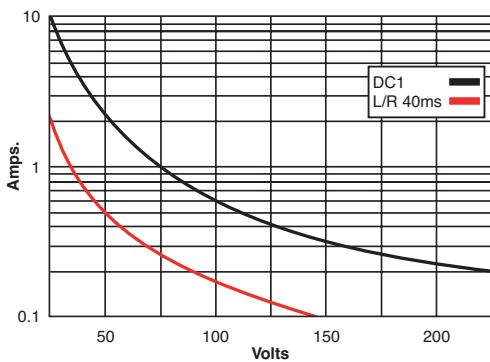
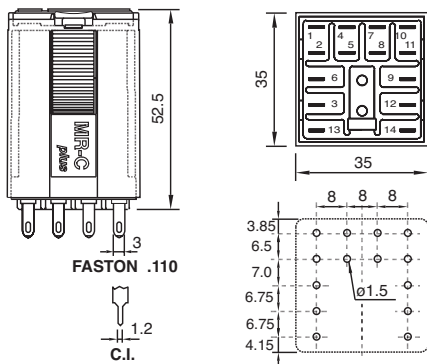

Table 2 Max. DC Load



Dimensions - mm



C4-R30



Magnetic latching relay
Three change-over contacts, 10 A

10 A 250 V AC1 0.5 A 110 V DC1
10 A 10 V DC1 0.2 A 220 V DC1

Contacts

Materials: Standard, code 0 AgNi
Optional, code 8 AgNi + 5μAu
Optional, code 9 AgNi + 0.2μ Au
Max. switching current 10 A
Max. peak inrush current (20 ms) 30 A
Max. switching voltage 250 V
Max. AC load (Table 1) 2.5 KVA
Max. DC load (Table 2)

Coils

ON pulse power 1.5 VA / W
OFF pulse power 0.5 VA / W
One winding for AC, Two windings for DC

VAC	ON mA	OFF mA	VDC	ON mA	OFF mA
24	75	12	12	125	41
48	38	6	24	63	21
115	16	2.5	48	31	10
230	8	1.3	110	14	4.5

Insulation

Dielectric strength (1 minute): Open contacts 1,000 V
Between adjacent poles 2.5 KV
Between contacts and coil 2.5 KV
Insulation resistance at 500 V ≥1 GΩ
Insulation, IEC 61810-1: 2.5 KV / 3

Specifications

Minimum, pulse length for ON / OFF 50 ms
Ambient temperature -40°C (no ice) to +60°C
Mechanical life ops. 10 Mill. AC, 20 Mill. DC relays
Electrical life at nominal load ≥100,000 ops.
Operating frequency at nominal load 1,200/hour
Protection degree IP 40/RT1
Weight avg. 95 g

Standard Types

AC 50 Hz, (60 Hz): 24, 48, 115, (120), 230, (240)
C4-R30..... VAC

DC 12, 24, 48, 110
C4-R30..... VDC

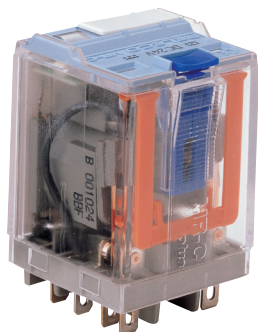

Relay compatible with sockets:
S5-S, S5-L, S5-P, S5-PO, S5-M

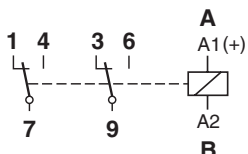

C5-A20



General purpose
Two change-over contacts

16 A 400 V AC1 0.5 A 110 V DC1
16 A 30 V DC1 0.2 A 220 V DC1

Contacts

Materials:	Standard, code 0	AgNi
	Optional, code 8	AgNi + 5μAu
	Optional, code 9	AgNi + 0.2μAu
Max. switching current		16 A
Max. peak inrush current (20 ms)		40 A
Max. switching voltage		400 V
Max. AC load (Table 1)		4 KVA
Max. DC load (Table 2)		

Coils (Ohms ±10% @ 20°C)

Pull-in voltage	≤0.8 x U_n
Drop-out voltage	≥0.1 x U_n
Nominal coil power	2.4 VA (AC)/1.4 W (DC)

VAC	Ω	mA	VDC	Ω	mA
24	65	100	24	414	58
48	286	50	48	1K6	30
115	1K7	21	110	8K1	13
230	6K8	10	220	35K6	6
400	18K8	6			

Table 1 Electrical Life, ops. x 10⁶

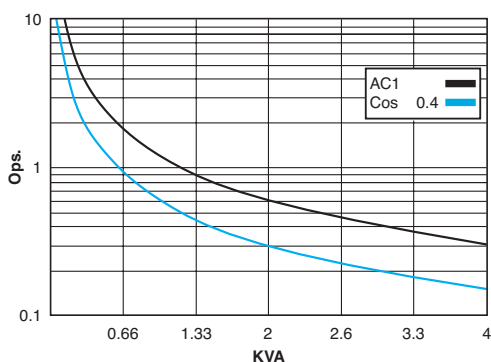
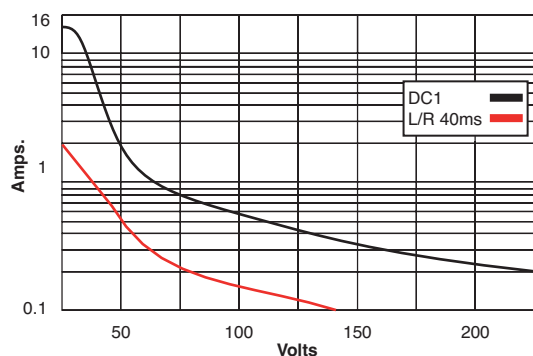

Table 2 Max. DC Load



Insulation

Dielectric strength (1 minute):	Open contacts	1,000 V
	Between adjacent poles	4 KV
	Between contacts and coil	4 KV
Insulation resistance at 500 V		≥3 GΩ
Insulation, IEC 61810-1:		4 KV/3

Specifications

Operate time + bounce time	20 ms
Release time + bounce time	10 ms
Ambient temperature	-40°C (no ice) to +60°C
Mechanical life ops.	10 Mill. AC, 20 Mill. DC relays
Electrical life at nominal load	≥100,000 ops.
Operating frequency at nominal load	1,200/hour
Protection degree	IP 40/RT1
Weight avg.	90 g

Dimensions - mm

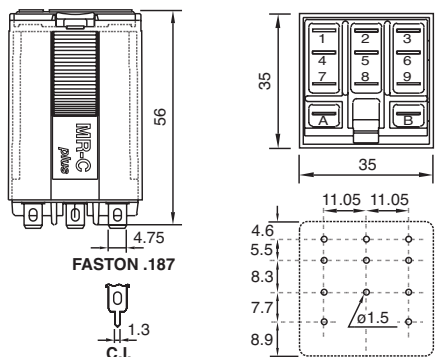

Standard Types

AC 50 Hz, (60 Hz): 24, 48, 115, (120), 230, (240), 400

X = LED (standard)	C5-A20X VAC
RC suppressor	C5-A20R..... VAC

DC 24, 48, 110, 220

X = LED, no polarity (standard)	C5-A20X VDC
Free-wheeling diode	C3-A20DX..... VDC
Polarity and free-wheeling diodes	C5-A20FX VDC
AC/DC bridge rectifier (24, 48 or 60 V)	C5-A20BX UC

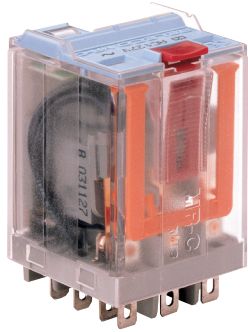

Relay compatible with sockets:
S5-S, S5-L, S5-P, S5-PO, S5-M

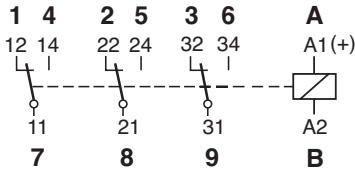

Table 1 Electrical Life, ops. x 10⁶

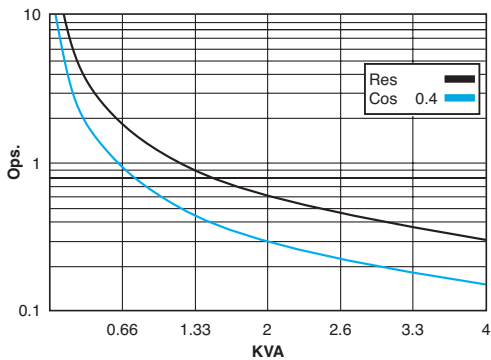
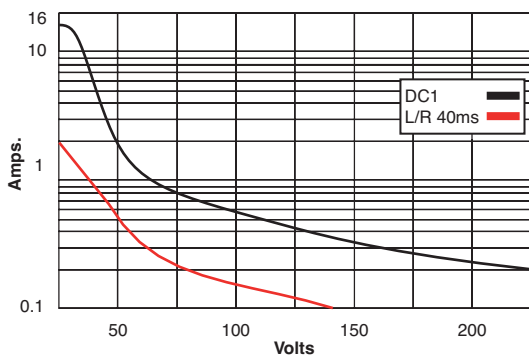
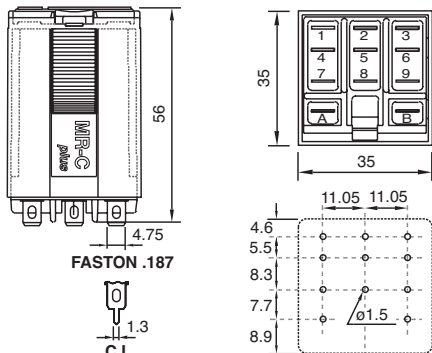

Table 2 Max. DC Load



Dimensions - mm



C5-A30



General purpose
Three change-over contacts

16 A 400 V AC1 0.5 A 110 V DC1
16 A 30 V DC1 0.2 A 220 V DC1

Contacts

Materials: Standard, code 0 AgNi
Max. switching current 16 A
Max. peak inrush current (20 ms) 40 A
Max. switching voltage 400 V
Max. AC load (Table 1) 4 KVA
Max. DC load (Table 2)

Coils (Ohms ±10% @ 20°C)

Pull-in voltage ≤0.8 x U_n
Drop-out voltage ≥0.1 x U_n
Nominal coil power 2.4 VA (AC)/1.4 W (DC)

VAC	Ω	mA	VDC	Ω	mA
24	65	100	24	414	58
48	286	50	48	1K6	30
115	1K7	21	110	8K1	13
230	6K8	10	220	35K6	6.5
400	18K8	6			

Insulation

Dielectric strength (1 minute): Open contacts 1,000 V
Between adjacent poles 4 KV
Between contacts and coil 4 KV
Insulation resistance at 500 V ≥3G Ω
Insulation, IEC 61810-1: 4 KV/3

Specifications

Operate time + bounce time 20 ms
Release time + bounce time 10 ms
Ambient temperature -40°C (no ice) to +60°C
Mechanical life ops. 10 Mill. AC, 20 Mill. DC relays
Electrical life at nominal load ≥100,000 ops.
Operating frequency at nominal load 1,200/hour
Protection degree IP 40/RT1
Weight avg. 95 g

Standard Types

AC 50 Hz, (60 Hz): 24, 48, 115, (120), 230, (240)
X = LED (standard) **C5-A30X** VAC
RC suppressor **C5-A30R**..... VAC

DC 24, 48, 110, 220
X = LED, no polarity (standard) **C5-A30X** VDC
Free-wheeling diode **C3-A30DX** VDC
Polarity and free-wheeling diodes **C5-A30FX** VDC
AC/DC bridge rectifier (24, 48 or 60V) **C5-A30BX** UC



Relay compatible with sockets:
S5-S, S5-L, S5-P, S5-PO, S5-M

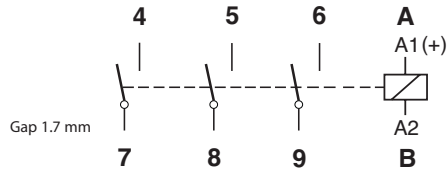

Table 1 Electrical Life, ops. x 10⁶

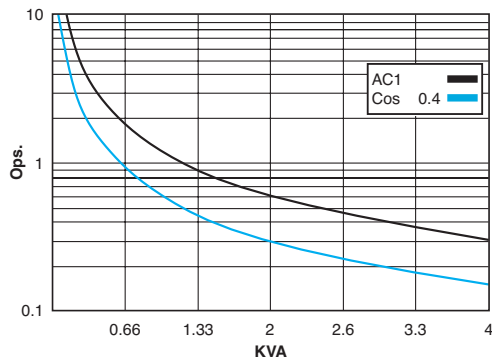
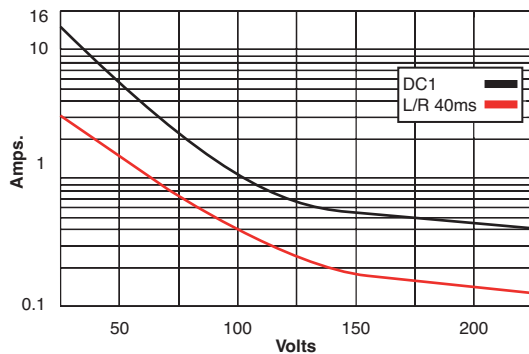
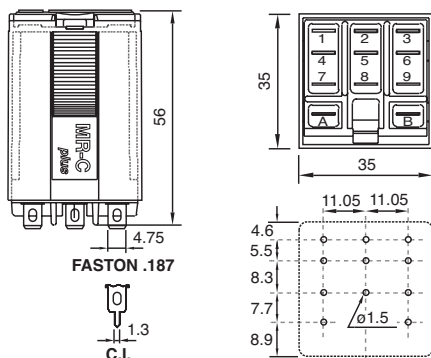

Table 2 Max. DC Load



Dimensions - mm



C5-G30



General purpose, DC applications
Three open contacts

16 A	400 V	AC1	1.2 A	110 V	DC1
16 A	30 V	DC1	0.4 A	220 V	DC1

Contacts

Materials:	Standard, code 0	AgNi
Max. switching current		16 A
Max. peak inrush current (20 ms)		40 A
Max. switching voltage		400 V
Max. AC load (Table 1)		4 KVA
Max. DC load (Table 2)		

Coils (Ohms ±10% @ 20°C)

Pull-in voltage	≤0.8 x U _n
Drop-out voltage	≥0.1 x U _n
Nominal coil power	2.4 VA (AC)/1.6 W (DC)

VAC	Ω	mA	VDC	Ω	mA
24	65	100	12	90	133
48	286	50	24	360	66
115	1K7	21	48	1K4	34
230	6K8	10	110	7K6	15
400	18K8	6	220	30K3	7.5

Insulation

Dielectric strength (1 minute): Open contacts	≥2,000 V
Between adjacent poles	4 KV
Between contacts and coil	4 KV
Insulation resistance at 500 V	≥3 GΩ
Insulation, IEC 61810-1:	4 KV/3

Specifications

Operate time + bounce time	20 ms
Release time + bounce time	10 ms
Ambient temperature	-40°C (no ice) to +60°C
Mechanical life ops.	10 Mill. AC, 20 Mill. DC relays
Electrical life at nominal load	≥100,000 ops.
Operating frequency at nominal load	1,200/hour
Protection degree	IP 40/RT1
Weight avg.	95 g

Standard Types

AC 50 Hz, (60 Hz): 24, 48, 115, (120), 230, (240)	
X = LED (standard)	C5-G30X VAC
RC suppressor	C5-G30R VAC
DC 24, 48, 110, 220	
X = LED, no polarity (standard)	C5-G30X VDC
Free-wheeling diode	C3-G30DX VDC
Polarity and free-wheeling diodes	C5-G30FX VDC
AC/DC bridge rectifier (24, 48 or 60 V)	C5-G30BX UC

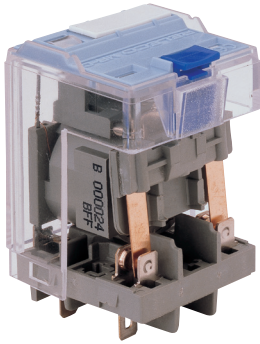

Relay compatible with sockets:
S5-S, S5-L, S5-P, S5-PO, S5-M

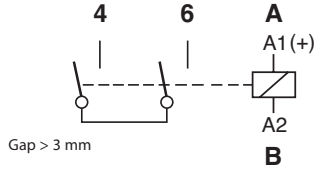

Table 1 Electrical Life, ops. x 10⁶

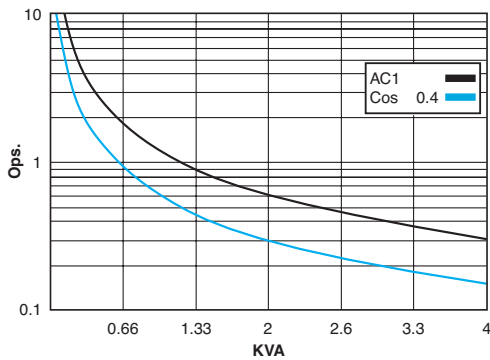
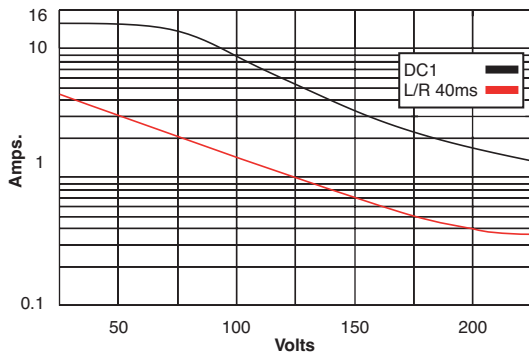
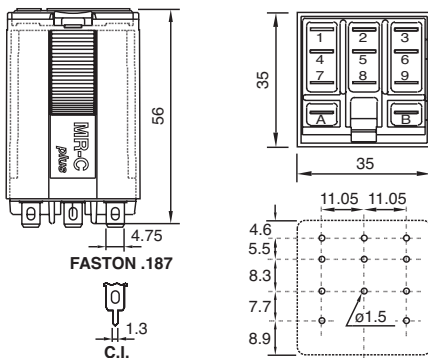

Table 2 Max. DC Load



Dimensions - mm



C5-X10



Power relay, DC applications
Single pole, N.O., double make

16 A 400 V AC1 7 A 110 V DC1
16 A 30 V DC1 1.2 A 220 V DC1

Contacts

Materials:	Standard, code 0	AgNi
Max. switching current		16 A
Max. peak inrush current (20 ms)		40 A
Max. switching voltage		400 V
Max. AC load (Table 1)		4 KVA
Max. DC load (Table 2)		

Coils (Ohms ±10% @ 20°C)

Pull-in voltage	≤0.8 x U _n
Drop-out voltage	≥0.1 x U _n
Nominal coil power	2.4 VA (AC)/1.3 W (DC)

VAC	Ω	mA	VDC	Ω	mA
24	65	100	12	110	108
48	286	50	48	443	54
115	1K7	21	48	1K7	27
230	6K8	10	110	9K2	12
400	18K8	6	220	34K5	6.5

Insulation

Dielectric strength (1 minute):	
Between adjacent poles	4 KV
Between contacts and coil	4 KV
Insulation resistance at 500 V	≥3 GΩ
Insulation, IEC 61810-1:	4 KV/3

Specifications

Operate time + bounce time	20 ms
Release time + bounce time	10 ms
Ambient temperature	-40°C (no ice) to +60°C
Mechanical life ops.	10 Mill. AC, 20 Mill. DC relays
Electrical life at nominal load	≥100,000 ops.
Operating frequency at nominal load	1,200/hour
Protection degree	IP 40/RT1
Weight avg.	90 g

Standard Types

AC 50 Hz, (60 Hz): 24, 48, 115, (120), 230, (240)	
X = LED (standard)	C5-X10X..... VAC
RC suppressor	C5-X10R..... VAC
DC 24, 48, 110, 220	
X = LED, no polarity (standard)	C5-X10X..... VDC
Free-wheeling diode	C5-X10DX..... VDC
Polarity and free-wheeling diodes	C5-X10FX..... VDC
AC/DC bridge rectifier (24, 48 or 60V)	C5-X10BX..... UC



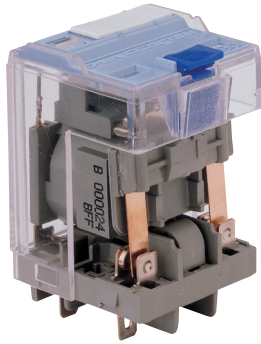

Relay compatible with sockets:
S5-S, S5-L, S5-P, S5-PO, S5-M

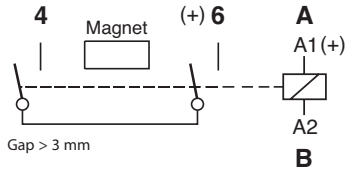

C5-M10



DC power relay
One N.O. pole, magnetic blow out

16 A 400 V AC1 10 A 220 V DC1
3.6 A 110V DCInd 2 A 220V DCInd

Contacts

Materials:	Standard, code 0	AgNi
Max. switching current		16 A
Max. peak inrush current (20 ms)		40 A
Max. switching voltage		400 V
Max. AC load (Table 1)		4 KVA
Max. DC load (Table 2)		

Coils (Ohms ±10% @ 20°C)

Pull-in voltage	≤0.8 x U_n
Drop-out voltage	≥0.1 x U_n
Nominal coil power	2.4 VA (AC)/1.3 W (DC)

VAC	Ω	mA	VDC	Ω	mA
24	65	100	12	110	108
48	286	50	48	443	54
115	1K7	21	48	1K7	27
230	6K8v	10	110	9K2	12
400	18K8	6	220	34K5	6.5

Table 1 Electrical Life, ops. x 10⁶

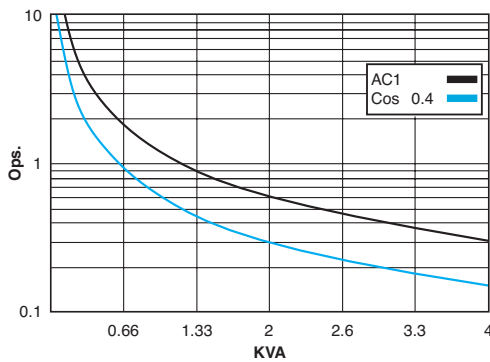
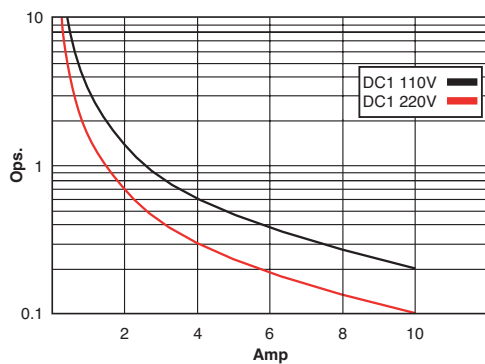

Table 2 DC Voltage Endurance



Insulation

Dielectric strength (1 minute):	
Open contacts	4,000 V
Between contacts and coil	4 KV
Insulation resistance at 500 V	≥3 GΩ
Insulation, EN 60947/IEC 61810-1:	4 KV/3

Specifications

Operate time + bounce time	20 ms
Release time + bounce time	10 ms
Ambient temperature	-40°C (no ice) to +60°C
Mechanical life ops.	10 Mill. AC relays, 20 Mill. DC relays
Electrical life at nominal load	≥100,000 ops.
Operating frequency at nominal load	1,200/hour
Protection degree	IP 40/RT1
Weight avg.	90 g

Dimensions - mm

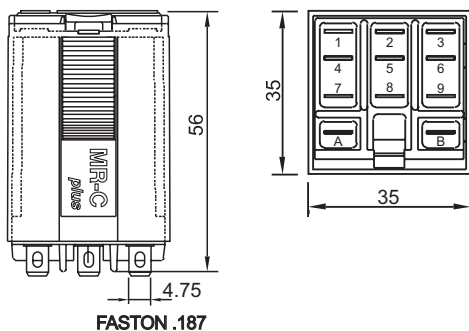

Standard Types (50 / 60 Hz and CC)

AC 24, 48, 115, (110 - 120), 230	
X = LED (standard)	C5-M10X..... VAC
RC suppressor	C5-M10R..... VAC
DC 12, 24, 48, 110, 120/125,220	
X = LED	C5-M10X..... VDC
Free-wheeling diodes	C5-M10DX VDC
Polarity and free-wheeling diodes	C5-M10FX..... VDC
AC/DC bridge rectifier (24, 48 or 60 V)	C5-M10BX UC

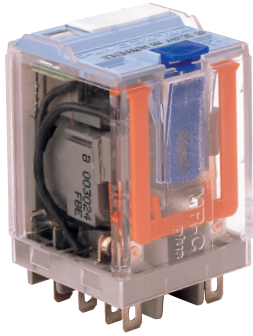

Relay compatible with sockets:
S5-S, S5-L, S5-P, S5-PO, S5-M

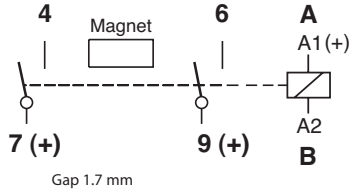

Table 1 Electrical Life, ops. x 10⁶

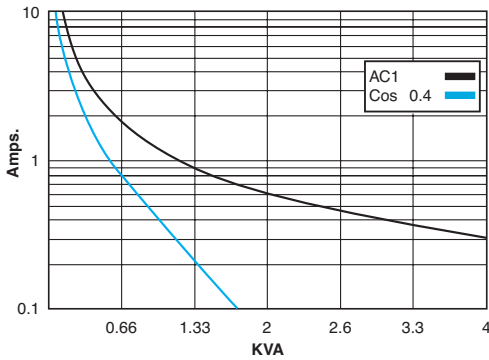
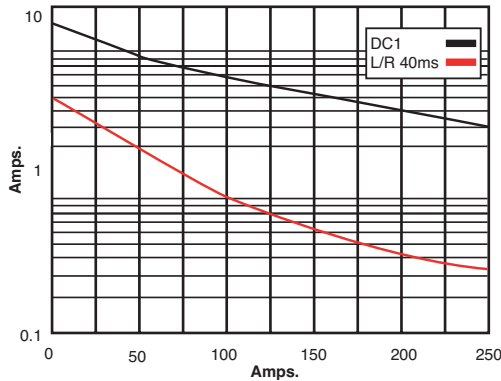
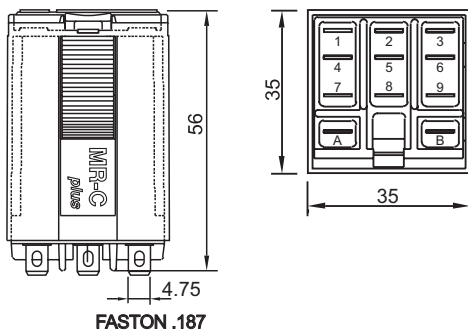

Table 2 Max. DC Load



Dimensions - mm



C5-M20



Power relay, DC
Double pole, N.O., magnetic blow out

16 A 250 V AC1 7 A 110 V DC1
3 A 220 V DC1

Contacts

Materials:	Standard, code 0	AgNi
Max. switching current		16 A
Max. peak inrush current (20 ms)		40 A
Max. switching voltage		250 V
Max. AC load (Table 1)		4 KVA
Max. DC load (Table 2)		

Coils (Ohms ±10% @ 20°C)

Pull-in voltage	0.8 x U _n
Drop-out voltage	0.1 x U _n
Nominal coil power	2.4 VA (CA) / 1.6 W (CC)

VAC	Ω	mA	VDC	Ω	mA
24	65	100	12	90	133
48	286	50	24	373	66
115	1K7	21	48	1K4	33
230	6K8	10.4	110	7K6	15

Insulation

Dielectric strength (1 minute):	
Open contacts	2 KV
Between adjacent poles	4 KV
Between contacts and coil	3 KV
Insulation resistance at 500 V	≥3 GΩ
Insulation, EN 60947/IEC 61810-1:	4 KV/3

Specifications

Operate time + bounce time	20 ms
Release time + bounce time	10 ms
Ambient temperature	-40°C (no ice) to +60°C
Mechanical life ops.	10 Mill. AC, 20 Mill. DC relays
Electrical life at nominal load	≥75,000 ops.
Operating frequency at nominal load	1,200/hour
Protection degree	IP 40/RT1
Weight avg.	90 g

Standard Types (50 / 60 Hz and CC)

AC 24, 48, 115, (120), 230 (240)	
X = LED (standard)	C5-M20X..... VAC
RC suppressor	C5-M20R..... VAC
DC 12, 24, 48, 110, 120/125, 220	
X = LED	C5-M20X..... VDC
Free-wheeling diodes	C5-M20DX..... VDC
Polarity and free-wheeling diodes	C5-M20FX..... VDC
AC/DC bridge rectifier (24, 48 or 60V)	C5-M20BX..... UC



Relay compatible with sockets:
S5-S, S5-L, S5-P, S5-PO, S5-M

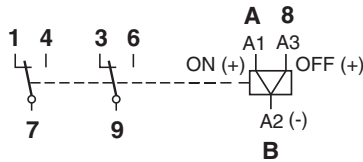

C5-R20



Magnetic latching relay
Two Change-over contacts, 10 A

10 A 400 V AC1 10 A 30 V DC1
0.2 A 220 V DC1 0.5 A 110 V DC1

Contacts

Materials:	Standard, code 0	AgNi
Max. switching current		10 A
Max. peak inrush current (20 ms)		30 A
Max. switching voltage		400 V
Max. AC load (Table 1)		4 KVA
Max. DC load (Table 2)		

Coils (Ohms ±10% @ 20°C)

ON pulse power	1.5 VA/W
OFF pulse power	0.5 VA/W
One winding for AC, two windings for DC	

VAC	ON mA	OFF mA	VDC	ON mA	OFF mA
24	75	12	12	125	41
48	38	6	24	63	21
115	16	2.5	48	31	10
230	8	1.3	110	14	4.5

Table 1 Electrical Life, ops. x 10⁶

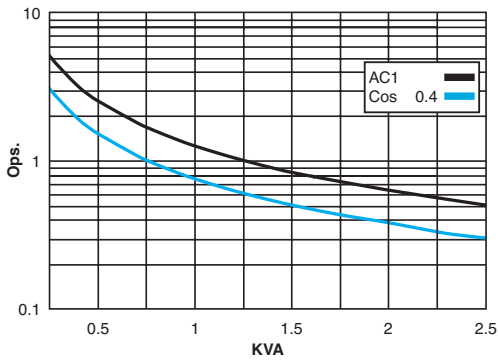
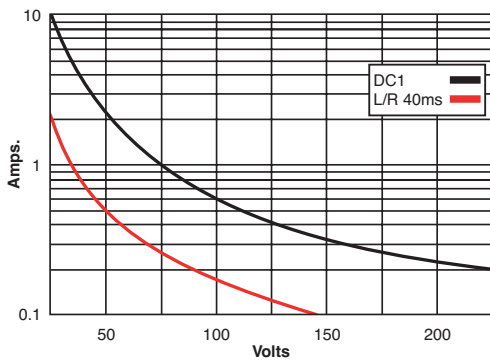
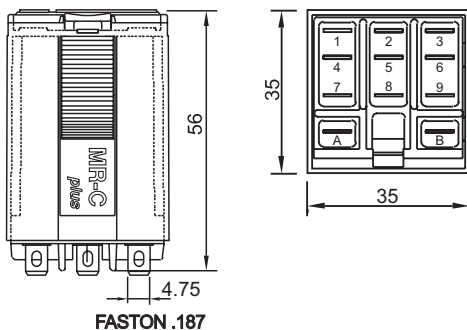

Table 2 Max. DC Load



Dimensions - mm



Insulation

Dielectric strength (1 minute):	
Open contacts	1,000 V
Between adjacent poles	4 KV
Between contacts and coil	4 KV
Insulation resistance at 500 V	≥3 GΩ
Insulation, EN 60947/IEC 61810-1:	4 KV/3

Specifications

Minimum, pulse length for ON / OFF	50 ms
Ambient temperature	-40°C (no ice) to +60°C
Mechanical life ops.	10 Mill. AC, 20 Mill. DC relays
Electrical life at nominal load	≥100,000 ops.
Operating frequency at nominal load	1,200/hour
Protection degree	IP 40/RT1
Weight avg.	95 g

Standard Types

AC 50 Hz, (60 Hz): 24, 48, 115, (110-120), 230, (240)	
C5-R20	VAC
DC 12, 24, 48, 110	
C5-R20	VDC

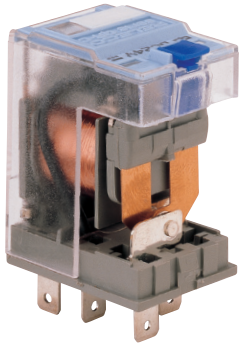

Relay compatible
with sockets:
S7-16

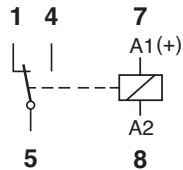

Table 1 Electrical Life, ops. x 10⁶

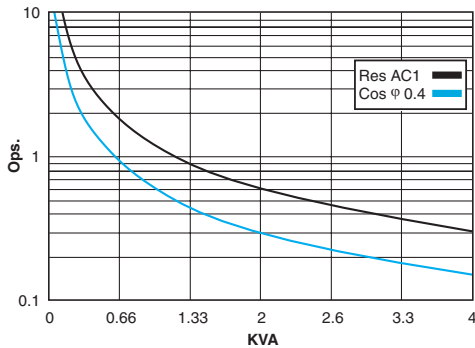
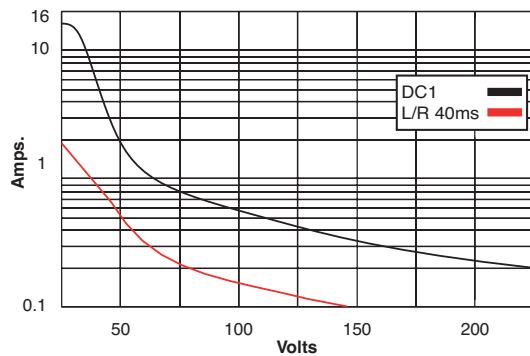
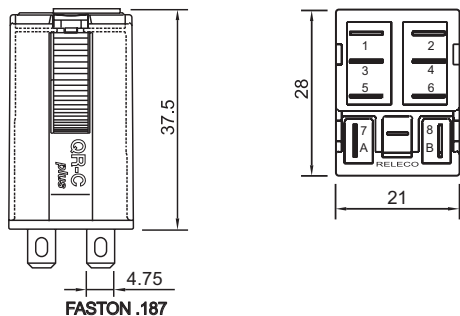

Table 2 Max. DC Load



Dimensions - mm



C7-A10



General purpose
One change-over contact, 16 A

16 A	250 V	AC1	0.5 A	110 V	DC1
16 A	30 V	DC1	0.2 A	220 V	DC1

Contacts

Materials:	Standard, code 0	AgNi
Max. switching current		16 A
Max. peak inrush current (20 ms)		40 A
Max. switching voltage		250 V
Max. AC load (Table 1)		4 KVA
Max. DC load (Table 2)		
Only plug-in S7-16 socket		

Coils (Ohms ±10% @ 20°C)

Pull-in voltage	≤0.8 x U _n
Drop-out voltage	≥0.1 x U _n
Nominal coil power	1.2 VA (AC)/1.3 W (DC)

VAC	Ω	mA	VDC	Ω	mA
24	174	50	12	111	108
48	686	25	24	432	55
115	4K3	10.4	48	1K7	28
230	18K6	5.2	110	9K2	12

Insulation

Dielectric strength (1 minute): Open contacts	1,000 V
Between contacts and coil	2.5 KV
Insulation resistance at 500 V	≥1 GΩ
Insulation, IEC 61810-1:	2.5 KV/3

Specifications

Operate time + bounce time	16 ms
Release time + bounce time	8 ms
Ambient temperature	-40°C (no ice) to +60°C
Mechanical life ops.	10 Mill. AC, 20 Mill. DC relays
Electrical life at nominal load	≥100,000 ops.
Operating frequency at nominal load	1,200/hour
Protection degree	IP 40/RT1
Weight avg.	43 g

Standard Types

AC 50 Hz, (60 Hz): 24, 48, 115, (120), 230, (240)	
X = LED (standard)	C7-A10X VAC
DC 12, 24, 48, 110,	
X = LED, no polarity (standard)	C7-A10X VDC
Free-wheeling diode	C7-A10DX VDC
Polarity and free-wheeling diodes	C7-A10FX VDC
AC/DC bridge rectifier (24, 48 or 60 V)	C7-A10BX UC

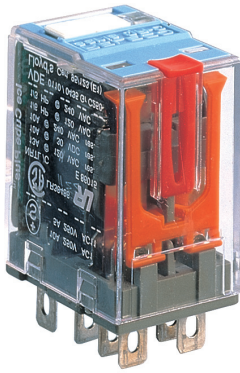

Relay compatible with sockets:

S7-C, S7-L, S7-P, S7-PO, S7-I/O

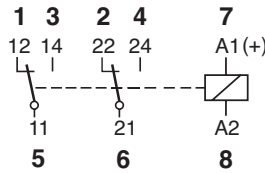

C7-A20



General purpose
Two pole, change-over contacts

10 A 250 V AC1 0.5 A 110 V DC1
10 A 30 V DC1 0.2 A 220 V DC1

Contacts

Materials:	Standard, code 0	AgNi
	Optional, code 8	AgNi + 5μ Au
	Optional, code 9	AgNi + 0.2μ Au
Max. switching current		10 A
Max. peak inrush current (20 ms)		30 A
Max. switching voltage		250 V
Max. AC load (Table 1)		2.5 KVA
Max. DC load (Table 2)		

Coils (Ohms ±10% @ 20°C)

Pull-in voltage	≤0.8 x U _n
Drop-out voltage	≥0.1 x U _n
Nominal coil power	1.2 VA (AC)/1 W (DC)

VAC	Ω	mA	VDC	Ω	mA
24	174	50	12	148	85
48	686	25	24	594	43
115	4K3	10.4	48	2k3	21
230	18K6	5.2	110	11K4	11

Table 1 Electrical Life, ops. x 10⁶

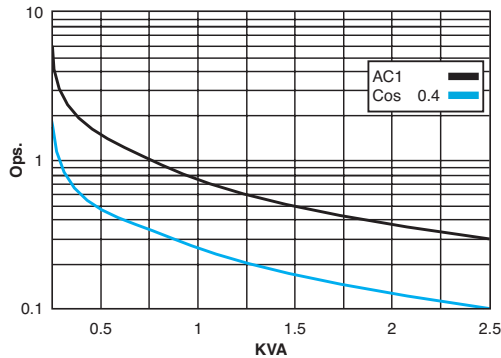
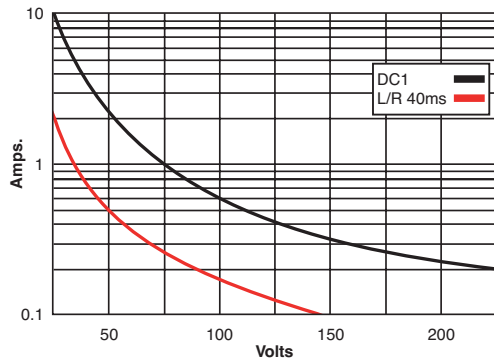
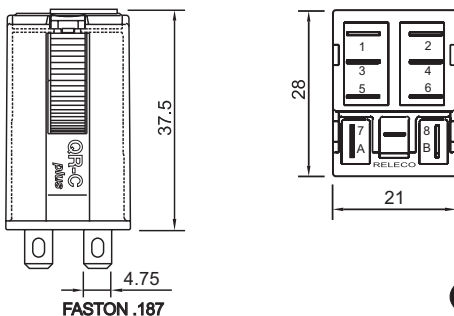

Table 2 Max. DC Load



Dimensions - mm



Insulation

Dielectric strength (1 minute): Open contacts	1,000 V
Between adjacent poles	2.5 KV
Between contacts and coil	2.5 KV
Insulation resistance at 500 V	≥1 GΩ
Insulation, IEC 61810-1:	2.5 KV/3

Specifications

Operate time + bounce time	16 ms
Release time + bounce time	8 ms
Ambient temperature	-40°C (no ice) to +60°C
Mechanical life ops.	10 Mill. AC, 20 Mill. DC relays
Electrical life at nominal load	≥100,000 ops.
Operating frequency at nominal load	1,200/hour
Protection degree	IP 40/RT1
Weight avg.	43 g

Standard Types

AC 50 Hz, (60 Hz): 24, 48, 72, 115, (120), 230, (240)	
X = LED (standard)	C7-A20X VAC
DC 12, 24, 48, 72, 110,	
X = LED, no polarity (standard)	C7-A20X VDC
Free-wheeling diode	C7-A20DX VDC
Polarity and free-wheeling diodes	C7-A20FX VDC
AC/DC bridge rectifier (24, 48 or 60 V)	C7-A20BX VDC

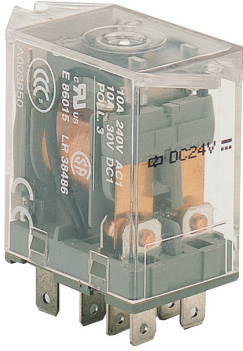

Relay compatible with sockets:

S7-C, S7-L, S7-P, S7-PO

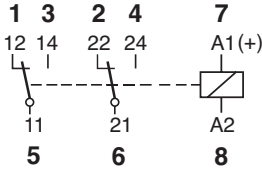

C7-A20E



General purpose
Two pole

10 A 250 V AC1 0.5 A 110 V DC1
10 A 30 V DC1 0.2 A 220 V DC1

Contacts

Materials:	Standard, code 0	AgNi
	Optional, code 8	AgNi + 5µ Au
	Max. switching current	10 A
	Max. peak inrush current (20 ms)	30 A
	Max. switching voltage	250 V
	Max. AC load (Table 1)	2.5 KVA
	Max. DC load (Table 2)	

Coils (Ohms ±10% @ 20°C)

Pull-in voltage	≤ 0.8 x U _n
Drop-out voltage	≥ 0.1 x U _n
Nominal coil power	1.2 VA (AC)/1 W (DC)

VAC	Ω	mA	VDC	Ω	mA
24	174	50	12	148	85
48	686	25	24	594	43
115	4K3	10.4	48	2K3	21
230	18K6	5.2	110	11K4	11

Table 1 Electrical Life, ops. x 10⁶

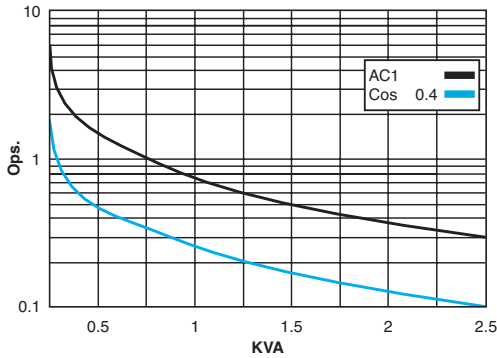
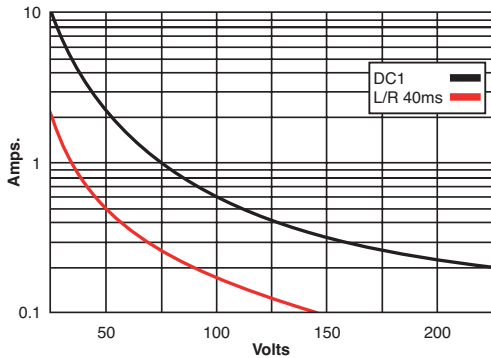

Table 2 Max. DC Load



Insulation

Dielectric strength (1 minute):	Open contacts	1,000 V
	Between adjacent poles	2.5 KV
	Between contacts and coil	2.5 KV
Insulation resistance at 500 V		≥ 3 GΩ
Insulation, IEC 61810-1:		2.5 KV/3

Specifications

Operate time + bounce time	16 ms
Release time + bounce time	8 ms
Ambient temperature	-40°C (no ice) to +70°C
Mechanical life ops.	10 Mill. AC, 20 Mill. DC relays
Electrical life at nominal load	≥ 100,000 ops.
Operating frequency at nominal load	1,200/hour
Protection degree	IP 40/RT1
Weight avg.	43 g

Dimensions - mm

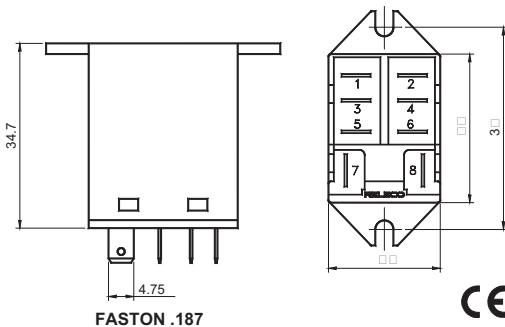

Standard Types

AC 50 Hz, (60 Hz): 24, 48, 115, (120), 230, (240)
C7-A20E..... VAC

DC 12, 24, 48, 110
C7-A20E..... VDC

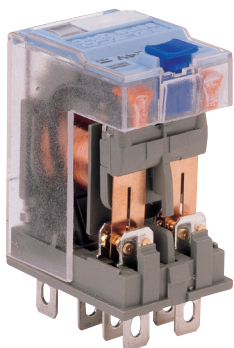

Relay compatible with sockets:

S7-C, S7-L, S7-P, S7-PO, S7-I/O

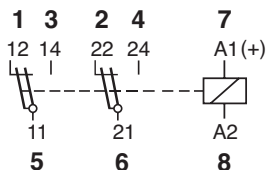

C7-T21

Low level
Two change-over bifurcated contacts

6 A 250 V Res 6 A 30 V DC1
Min. contacts load: 1 mA / 5 V DC1

Contacts

Materials:	Standard, code 1	AgNi + 0.3μ Au
	Optional, code 2	AgNi + 5μ Au
Max. switching current		6 A
Max. peak inrush current (20 ms)		15 A
Max. switching voltage		250 V
Max. AC load (Table 1)		1.2 KVA
Max. DC load (Table 2)		

Coils (Ohms ±10% @ 20°C)

Pull-in voltage	≤0.8 x U _n
Drop-out voltage	≥0.1 x U _n
Nominal coil power	1.2 VA (AC)/1 W (DC)

VAC	Ω	mA	VDC	Ω	mA
24	174	50	12	148	85
48	686	25	24	594	43
115	4K3	10.4	48	2K3	21
230	18K6	5.2	110	11K4	11

Table 1 Electrical Life, ops. x 10⁶

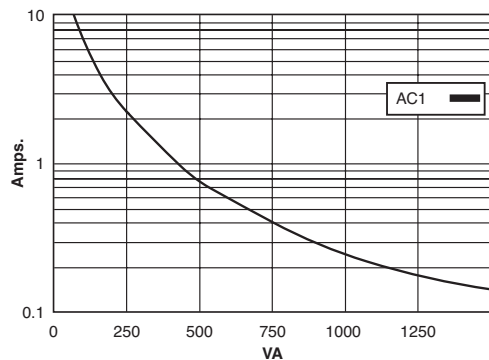
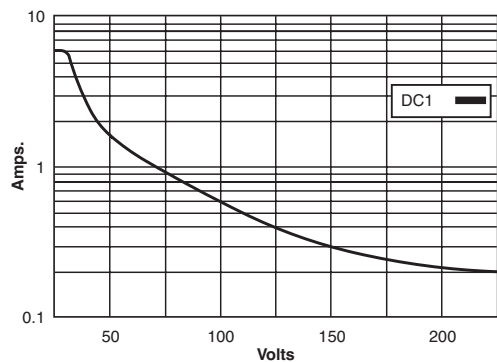
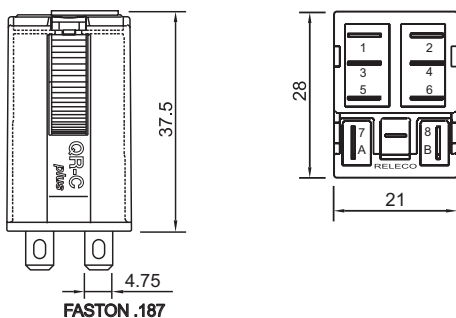

Table 2 Max. DC Load



Dimensions - mm



Insulation

Dielectric strength (1 minute): Open contacts	1,000 V
Between adjacent poles	2.5 KV
Between contacts and coil	2.5 KV
Insulation resistance at 500 V	≥1 GΩ
Insulation, IEC 61810-1:	2.5 KV/3

Specifications

Operate time + bounce time	16 ms
Release time + bounce time	8 ms
Ambient temperature	-40°C (no ice) to +70°C
Mechanical life ops.	10 Mill. AC, 20 Mill. DC relays
Electrical life at nominal load	≥100,000 ops.
Operating frequency at nominal load	1,200/hour
Protection degree	IP 40/RT1
Weight avg.	43 g

Standard Types

AC 50 Hz, (60 Hz): 24, 48, 115, (120), 230, (240)	
X = LED (standard)	C7-T21X VAC
DC 12, 24, 48, 110	
X = LED, no polarity (standard)	C7-T21X VDC
Free-wheeling diode	C7-T21DX VDC
Polarity and free-wheeling diodes	C7-T21FX VDC
AC/DC bridge rectifier (24, 48 or 60 V)	C7-T21BX UC

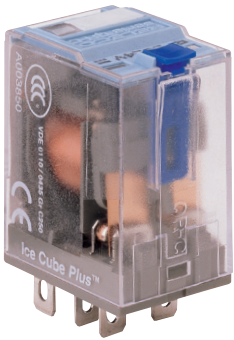

Relay compatible with sockets:

S7-C, S7-L, S7-P, S7-PO, S7-I/O

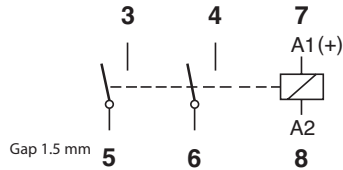

C7-G20



Power relay, DC application
Two open contacts, Gap 1.5 mm

10 A 250 V AC1 0.8 A 110 V DC1
10A 30 V DC1 0.4 A 220 V DC1

Contacts

Materials:	Standard, code 0	AgNi
Max. switching current		10 A
Max. peak inrush current (20 ms)		30 A
Max. switching voltage		250 V
Max. AC load (Table 1)		2.5 KVA
Max. DC load (Table 2)		

Table 1 Electrical Life, ops. x 10⁶

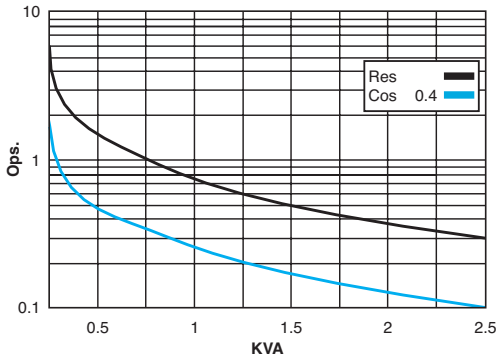
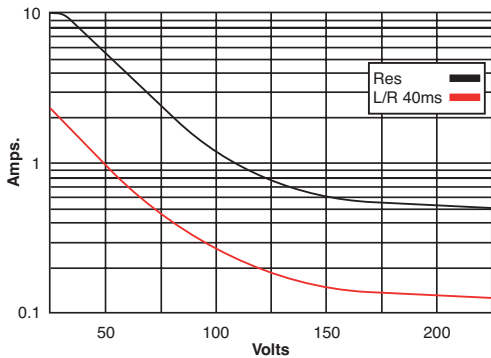
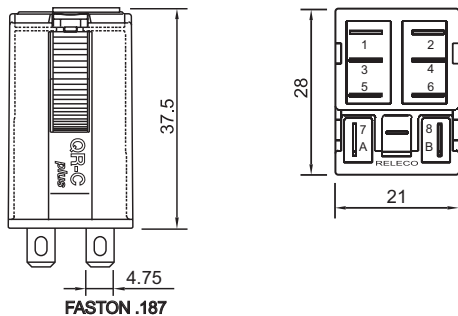

Table 2 Max. DC Load



Dimensions - mm



Coils (Ohms ±10% @ 20°C)

Pull-in voltage	≤0.8 x U _n
Drop-out voltage	≥0.1 x U _n
Nominal coil power	1.5 VA (AC)/1.5 W (DC)

VAC	Ω	mA	VDC	Ω	mA
24	153	62	12	99	121
48	611	31	24	388	61
115	3K6	13	48	1K5	32
230	14K6	6.5	110	8K	14

Insulation

Dielectric strength (1 minute): Open contacts	2,000 V
Between adjacent poles	2.5 KV
Between contacts and coil	2.5 KV
Insulation resistance at 500 V	≥1 GΩ
Insulation, IEC 61810-1:	2.5 KV/3

Specifications

Operate time + bounce time	20 ms
Release time + bounce time	10 ms
Ambient temperature	-40°C (no ice) to +60°C
Mechanical life ops.	10 Mill. AC, 20 Mill. DC relays
Electrical life at nominal load	≥100,000 ops.
Operating frequency at nominal load	1,200/hour
Protection degree	IP 40/RT1
Weight avg.	43 g

Standard Types

AC 50 Hz, (60 Hz): 24, 48, 115, (120), 230, (240)
X = LED (standard) **C7-G20X VAC**

DC 12, 24, 48, 110
X = LED, no polarity (standard) **C7-G20X VDC**
Free-wheeling diode **C7-G20DX VDC**
Polarity and free-wheeling diodes **C7-G20FX VDC**
AC/DC bridge rectifier (24, 48 or 60 V) **C7-G20BX UC**

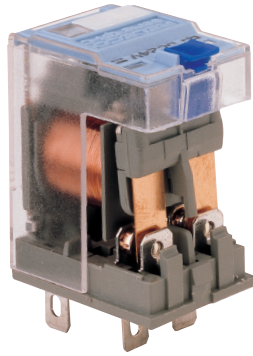

Relay compatible with sockets:

S7-C, S7-L, S7-P, S7-PO, S7-I/O

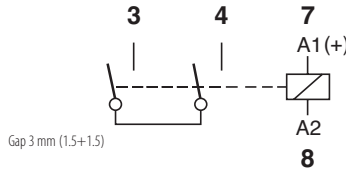

C7-X10



Power relay, DC application
Single pole, NO, double make

10 A	250 V	AC1	6 A	110 V	DC1
10 A	30V	DC1	1 A	220 V	DC1

Contacts

Materials:	Standard, code 0	AgNi
Max. switching current		10 A
Max. peak inrush current (20 ms)		30 A
Max. switching voltage		250 V
Max. AC load (Table 1)		2.5 KVA
Max. DC load (Table 2)		

Coils (Ohms ±10% @ 20°C)

Pull-in voltage	≤0.8 x U _n
Drop-out voltage	≥0.1 x U _n
Nominal coil power	1.5 VA (AC)/1.3 W (DC)

VAC	Ω	mA	VDC	Ω	mA
24	153	62	12	111	108
48	611	31	24	432	55
115	3K6	13	48	1K7	27
230	14K6	6.5	110	9K2	12

Table 1 Electrical Life, ops. x 10⁶

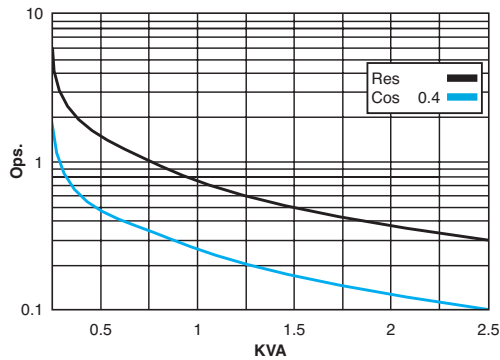
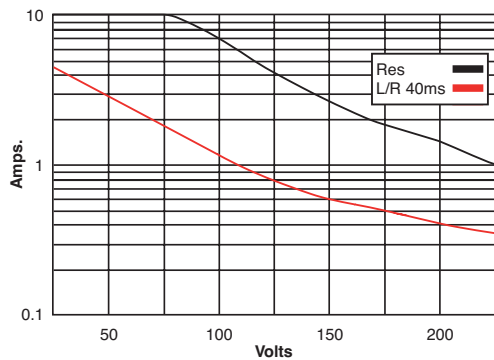
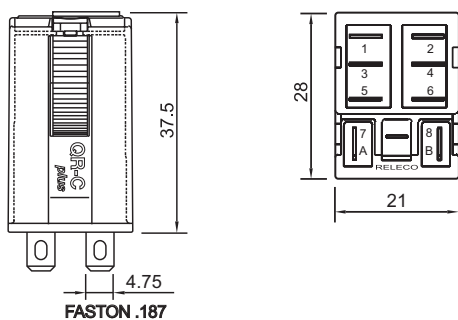

Table 2 Max. DC Load



Dimensions - mm



Insulation

Dielectric strength (1 minute):	
Open contacts	2.5 KV
Between contacts and coil	2.5 KV
Insulation resistance at 500 V	≥1 GΩ
Insulation, IEC 61810-1:	2.5 KV/3

Specifications

Operate time + bounce time	20 ms
Release time + bounce time	10 ms
Ambient temperature	-40°C (no ice) to +60°C
Mechanical life ops.	10 Mill. AC, 20 Mill. DC relays
Electrical life at nominal load	≥100,000 ops.
Operating frequency at nominal load	1,200/hour
Protection degree	IP 40/RT1
Weight avg.	43 g

Standard Types

AC 50 Hz, (60 Hz): 24, 48, 115, (120), 230, (240)
X = LED (standard) C7-X10X..... VAC

DC 12, 24, 48, 110
X = LED, no polarity (standard) C7-X10X..... VDC
Free-wheeling diode C7-X10DX VDC
Polarity and free-wheeling diodes C7-X10FX..... VDC
AC/DC bridge rectifier (24, 48 or 60 V) C7-X10BX UC

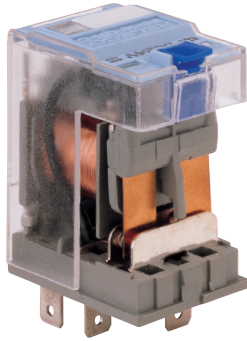

Relay compatible with sockets:

S7-C, S7-L, S7-P, S7-PO, S7-I/O

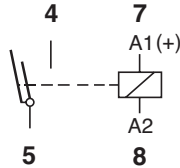
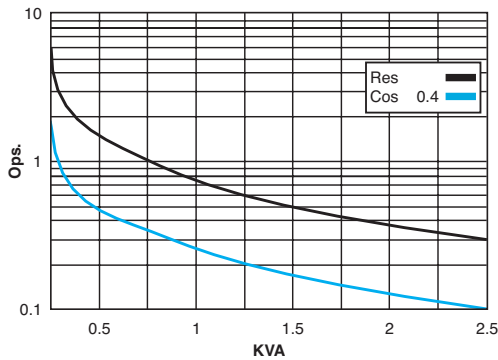
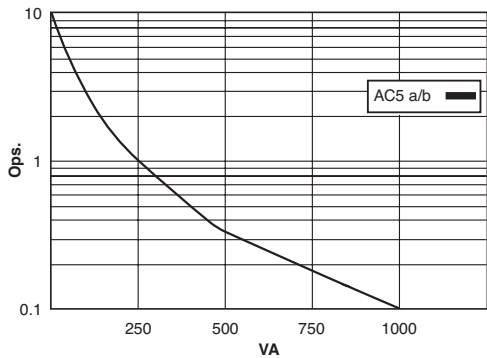

Table 1 Electrical Life, ops. x 10⁶



t Max. DC Load



Dimensions - mm

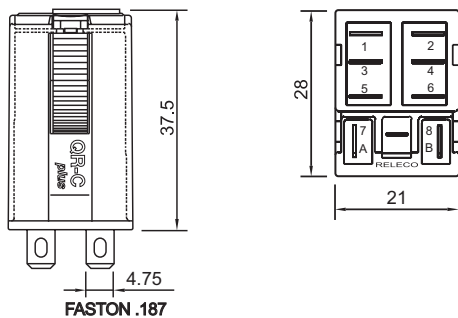

C7-W10



High inrush current
Single pole, tungsten contacts

10 A 250 V AC 250 V AC5a/b

Contacts

Materials:	Standard, code 0	AgNi
Max. switching current		10 A
Max. peak inrush current (2.5 ms)		500 A
Max. switching voltage		250 V
Max. AC load (Table 1)		2.5 KVA
Max. DC load (Table 2)		

Coils (Ohms ±10% @ 20°C)

Pull-in voltage	≤0.8 x U _n
Drop-out voltage	≥0.1 x U _n
Nominal coil power	1.5 VA (AC)/1.5 W (DC)

VAC	Ω	mA	VDC	Ω	mA
24	153	62	12	99	121
48	611	31	24	388	61
115	3K6	13	48	1K5	32
230	14K6	4.5	110	8K	14

Insulation

Dielectric strength (1 minute):	
Open contacts	1,000 V
Between contacts and coil	2.5 KV
Insulation resistance at 500 V	≥1 GΩ
Insulation, IEC 61810-1:	2.5 KV

Specifications

Operate time + bounce time	20 ms
Release time + bounce time	10 ms
Ambient temperature	-40°C (no ice) to +70°C
Mechanical life ops.	10 Mill. AC, 20 Mill. DC relays
Electrical life at nominal load	≥100,000 ops.
Operating frequency at nominal load	1,200/hour
Protection degree	IP 40/RT1
Weight avg.	43 g

Standard Types

AC 50 Hz, (60 Hz): 24, 48, 115, (120), 230, (240)
X = LED (standard) **C7-W10X..... VAC**

DC 12, 24, 48, 110
X = LED, no polarity (standard) **C7-W10X..... VDC**
Free-wheeling diode **C7-W10DX VDC**
Polarity and free-wheeling diodes **C7-W10FX VDC**
AC/DC bridge rectifier (24, 48 or 60 V) **C7-W10BX UC**

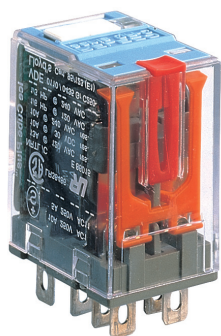

Relay compatible with sockets:

S7-C, S7-L, S7-P, S7-PO, S7-I/O

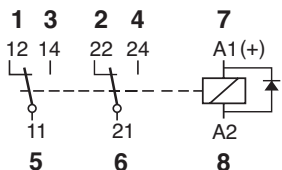

Table 1 Electrical Life, ops. x 10⁶

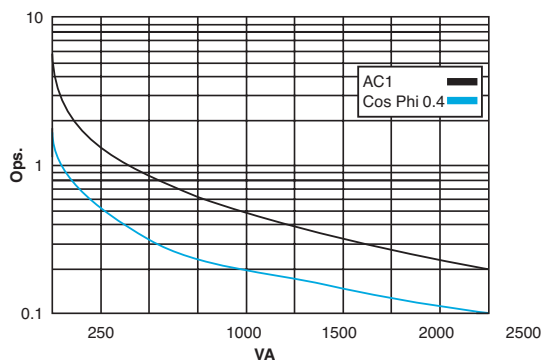
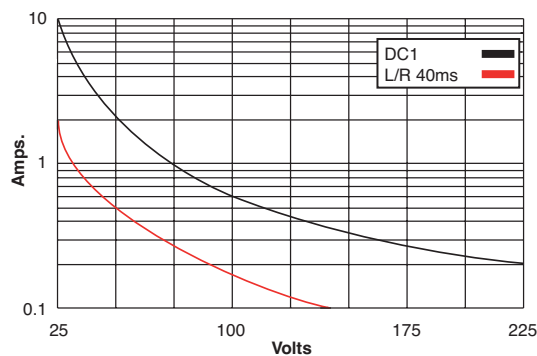
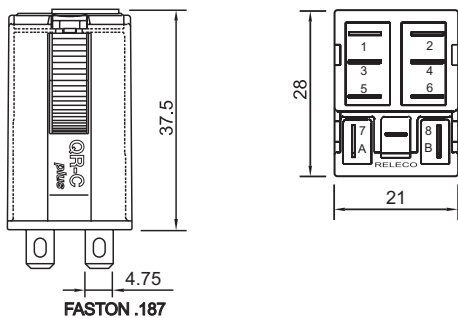

Table 2 Max DC Load



Dimensions - mm



R7-A20



Railway Application Relay

According to EN 60077-1-2/99 - EN 61373/99

10 A 250 V AC1 10 A 30 V DC1

Contacts

Materials:	Standard, code 0	AgNi
	Optional, code 4	AgNi + 0.2μ Au
	Optional, code 8	AgNi + 10μ Au
Max. switching current		10 A
Max. peak inrush current (20 ms)		30 A
Max. switching voltage		250 V
Max. AC load (Table 1)		
Max. DC load (Table 2)		

Coils

Operation Range	0.7 Un @ 1.25 Un
Power Consumption	>0.1 Un
Power Consumption	1.07 W
Generated transients	OV, include FWD

Voltage	Ω ± 10%	mA
24	535	45
48	2004	24
72	4750	15
110	11337	10

Isolation

Polution grade	PD3
With voltage (1.2/50μs) / Dielectric strength (1 minute)	
Contact coil	4 KV/2,220 V
Between different poles	4 KV/2,220 V
Between contacts on the same pole	1,550 V

Specifications

Ambient temperature	-25°C to +70°C
Number of mechanical operations	20 million
Thermic Class B (130°C)	
Vibration: Category/Class	1/B Body Mounted
Vibration	5-150 Hz (3 axes)
Shock	5 g (3 axes)
Operation (UN)/release time	10 ms/15 ms
Weight avg.	35 g
Weight avg. Relay + Socket	75 g
Relay Protection	IP 40

Standard Types

DC 24, 48, 72, 110	
Free-wheeling diode	R7-A20DVDC



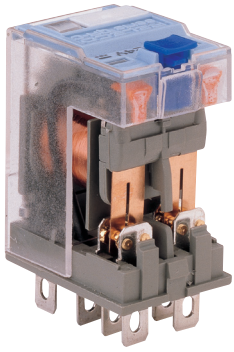

Relay compatible with sockets:

S7-C, S7-L, S7-P, S7-PO, S7-I/O

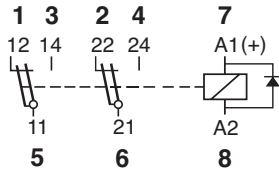

R7-T21



Railway Application Relay

According to EN 60077-1-2/99 - EN 61373/99

6 A 250 V AC1 6 A 30 V DC1

Contacts

Materials:	Standard, code 1	AgNi + 0.2µ Au
	Optional, code 2	AgNi + 10µ Au
Max. switching current		6 A
Max. peak inrush current (20 ms)		15 A
Max. switching voltage		250 V
Max. AC load (Table 1)		
Max. DC load		100,000 ops.

Table 1 Electrical Life, ops. x 10⁶

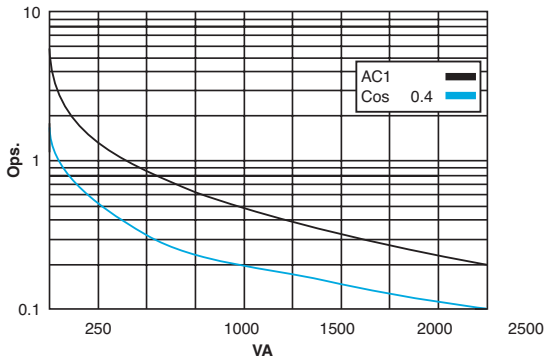
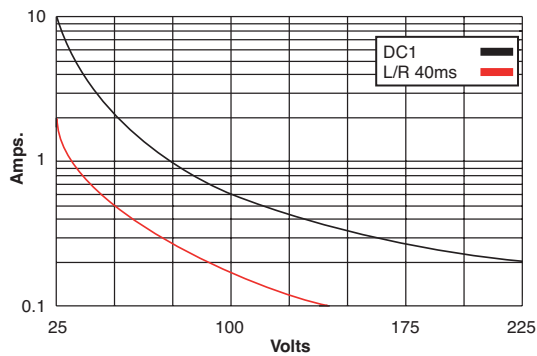
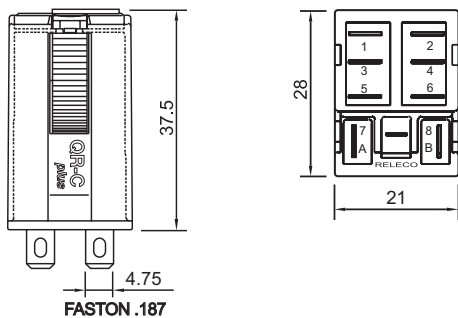

Table 2 Max DC Load



Dimensions - mm



Coils

Operation Range	0.7 U _n @ 1.25 U _n
Power Consumption	>0.1 U _n
Power Consumption	1.07 W
Generated transients	OV, include FWD

Voltage	Ω ± 10%	mA
24	535	45
48	2004	24
72	4750	15
110	11337	10

Isolation

Polution grade	PD3
With voltage (1.2 / 50µs)/Dielectric strength (1 minute)	
Contact coil	4 KV/2,220 V
Between different poles	4 KV/2,220 V
Between contacts on the same pole	1,550 V

Specifications

Ambient temperature	-25°C to +70°C
Number of mechanical operations	20 million
Thermic Class B (130°C)	
Vibration: Category/Class	1/B Body Mounted
Vibration	5-150 Hz (3 axes)
Shock	5 g (3 axes)
Operation (UN)/release time	10 ms/15 ms
Weight avg.	35 g
Weight avg. Relay + Socket	75 g
Relay Protection	IP 40

Standard Types

DC 24, 48, 72, 110

Free-wheeling diode

R7-T21D.....VDC



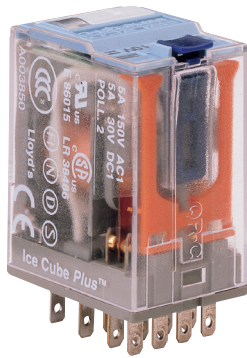

Relay compatible with sockets:
S9-M, S9-L, S9-P, S9-PO

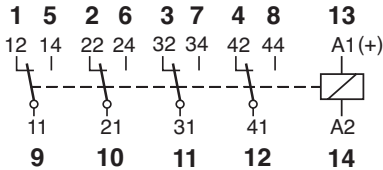

C9-A41



General purpose
Four pole, change-over contacts

5 A 250 V AC1
5 A 30 V DC1 0.2 A 110 V DC1

Contacts

Materials: Standard, code 1 AgNi + 0.2μAu
Optional, code 2 AgNi + 5μAu
Max. switching current 5 A
Max. peak inrush current (2.5 ms) 15 A
Max. switching voltage 250 V
Max. AC load (Table 1) 1250 KVA
Max. DC load (Table 2)

Coils (Ohms ±10% @ 20°C)

Pull-in voltage ≤0.8 x U_n
Drop-out voltage ≥0.1 x U_n
Nominal coil power 1.2 VA (AC)/1 W (DC)

VAC	Ω	mA	VDC	Ω	mA
24	174	50	12	148	85
48	686	25	24	594	43
115	4K3	10.4	48	2K3	21
230	18K6	5.2	110	11K4	11

Table 1 Electrical Life, ops. x 10⁶

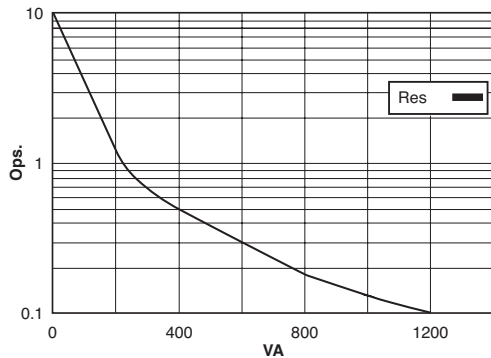
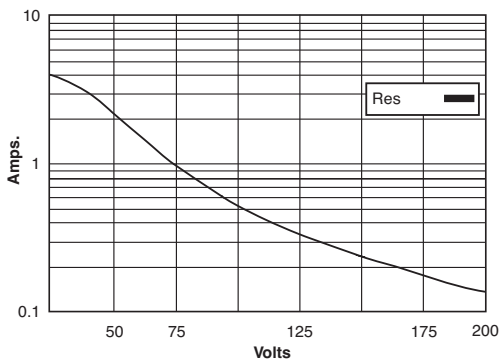
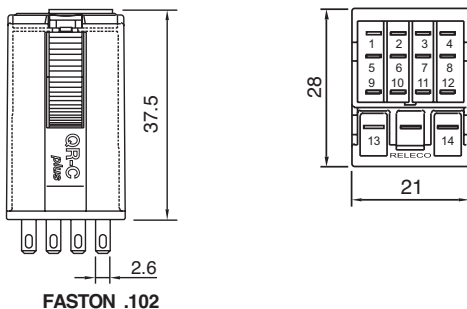

Table 2 Max. DC Load



Dimensions - mm



Insulation

Dielectric strength (1 minute): Open contacts 1,000 V
Between adjacent poles 2 KV
Between contacts and coil 2.5 KV
Insulation resistance at 500 V ≥1 GΩ
Insulation, IEC 61810-1: 2.5 KV

Specifications

Operate time + bounce time 10 ms
Release time + bounce time 6 ms
Ambient temperature -40°C (no ice) to +60°C
Mechanical life ops. 10 Mill. AC, 20 Mill. DC relays
Electrical life at nominal load ≥100,000 ops.
Operating frequency at nominal load 1,200/hour
Protection degree IP 40/RT1
Weight avg. 43 g

Standard Types

AC 50 Hz, (60 Hz): 24, 48, 72, 115, (120), 230, (240)
X = LED (standard) C9-A41X VAC
DC 12, 24, 48, 72, 110
X = LED, no polarity (standard) C9-A41X VDC
Free-wheeling diode C9-A41DX VDC
Polarity and free-wheeling diodes C9-A41FX VDC
AC/DC bridge rectifier (24, 48 or 60 V) C9-A41BX UC

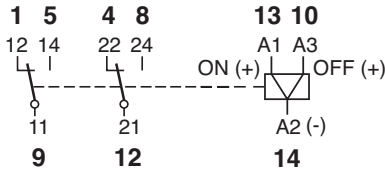
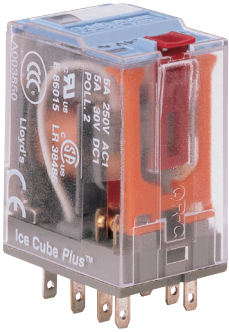

C9-R21



Magnetic latching relay
Two change-over contacts, 5 A

5 A 120 V AC1
5 A 30 V DC1

Contacts

Materials:	Standard, code 1	AgNi + 0.2µAu
Max. switching current		5 A
Max. peak inrush current (10 ms)		15 A
Max. switching voltage		120 V
Max. AC load (Table 1)		600 VA
Max. DC load (Table 2)		

Table 1 Electrical Life, ops. x 10⁶

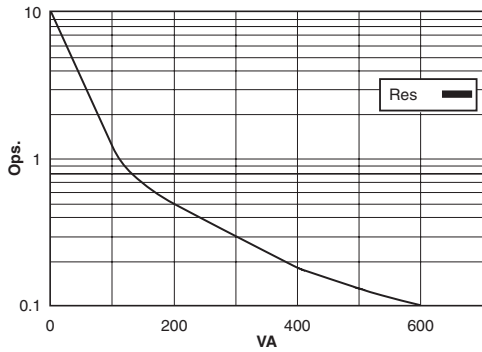
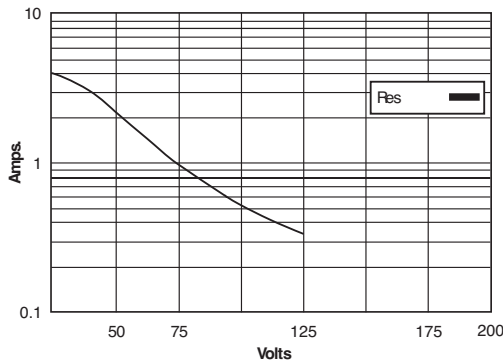
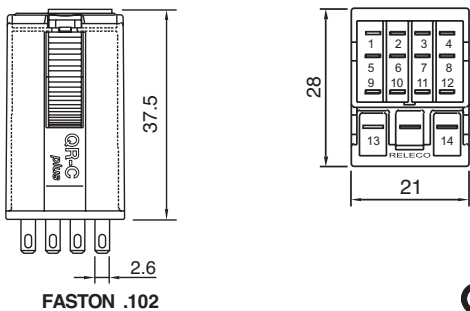

Table 2 Max. DC Load



Dimensions - mm



Coils

ON pulse power	1.2 VA/W
OFF pulse power	0.3 VA/W
One winding for AC. Two windings for DC.	

VAC	ON mA	OFF mA	VDC	ON mA	OFF mA
24	50	8	12	100	25
48	25	4	24	50	12
115	10	2	48	25	6
230	5	1	60	20	5

Insulation

Dielectric strength (1 minute): Open contacts	1,000 V
Between adjacent poles	2 kV
Between contacts and coil	2 kV
Insulation resistance at 500 V	≥1 GΩ
Insulation, IEC 61810-1:	2.5 kV/2

Specifications

Minimum, pulse length for ON/OFF	50 ms
Ambient temperature	-40°C (no ice) to +60°C
Mechanical life ops.	10 Mill. AC, 20 Mill. DC relays
Electrical life at nominal load	≥100,000 ops.
Operating frequency at nominal load	1,200/hour
Protection degree	IP 40/RT1
Weight avg.	43 g

Standard Types

AC 50 Hz, (60 Hz): **24, 48, 115, (120), 230, (240)**
C9-R21 VAC

DC **12, 24, 48, 60**
C9-R21 VDC

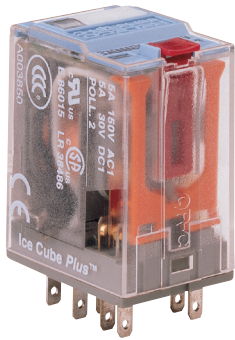

Relay compatible with sockets:
S9-M, S9-L, S9-P, S9-PO

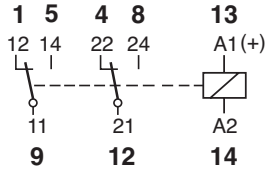

C9-E21



General purpose. Sensitive 500 mW
Two pole, change-over contacts
DC operating range: 0.8-1.7 x U_n

5 A 250 V AC1 5 A 30 V DC1

Contacts

Materials:	Standard, code 1	AgNi + 0,2µAu
	Optional, code 2	AgNi + 10µAu
Max. switching current		5 A
Max. peak inrush current (2.5 ms)		15 A
Max. switching voltage		250 V
Max. AC load (Table 1)		1,200 VA
Max. DC load (Table 2)		

Coils (Ohms ±10% @ 20°C)

Pull-in voltage	≤0.8 x U _n
Drop-out voltage	≥0.1 x U _n
Nominal coil power	0.8 VA (AC)/0.5 W (DC)

VAC	Ω	mA	VDC	Ω	mA
24	238	33	12	288	42
48	1K	17	24	1K1	21
115	5K9	7	48	4K6	10
230	23K9	3.5	110	24K2	4.5

Table 1 Electrical Life, ops. x 10⁶

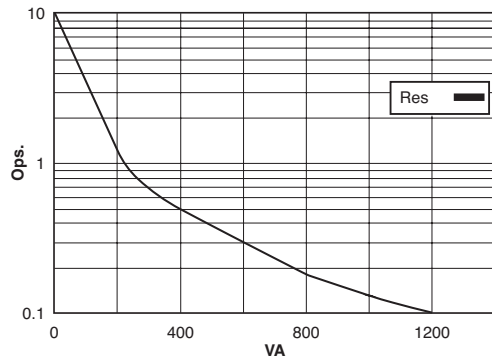
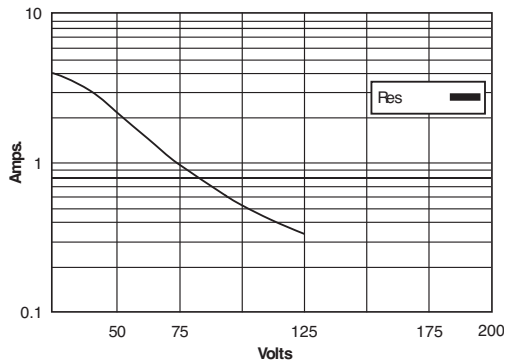
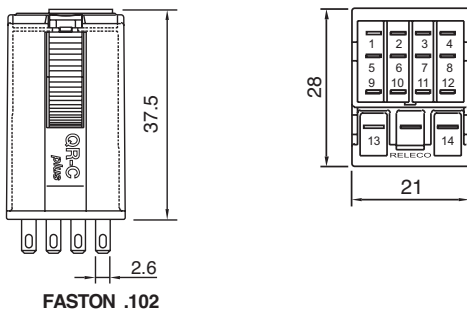

Table 2 Max. DC Load



Dimensions - mm



Insulation

Dielectric strength (1 minute): Open contacts	1,000 V
Between adjacent poles	2.5 KV
Between contacts and coil	2.5 KV
Insulation resistance at 500 V	≥1 GΩ
Insulation, IEC 61810-1:	2.5 KV/3

Specifications

Operate time + bounce time	10 ms
Release time + bounce time	6 ms
Ambient temperature	-40°C (no ice) to +60°C
Mechanical life ops.10 Mill. AC, 20 Mill. DC relays	Electrical life at nominal load ≥100,000 ops.
Operating frequency at nominal load	1,200/hour
Protection degree	IP 40/RT1
Weight avg.	40 g

Standard Types

AC 50 Hz, (60 Hz): 24, 48, 115, (120), 230, (240)
X = LED (standard) **C9-E21X..... VAC**

DC 12, 24, 48, 110
X = LED, no polarity (standard) **C9-E21X.....VDC**
Free-wheeling diode **C9-E21DX.....VDC**
Polarity and free-wheeling diodes **C9-E21FX.....VDC**
AC/DC bridge rectifier (24, 48 or 60 V) **C9-E21BX..... UC**

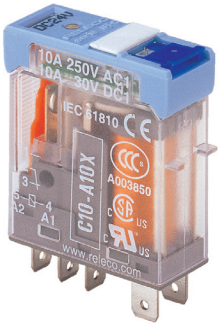

Relay compatible with sockets:
S10, S10-P

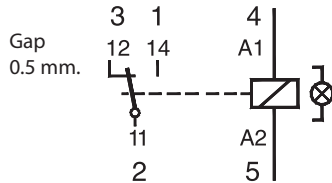

Table 1 Electrical Life, ops. x 10⁶

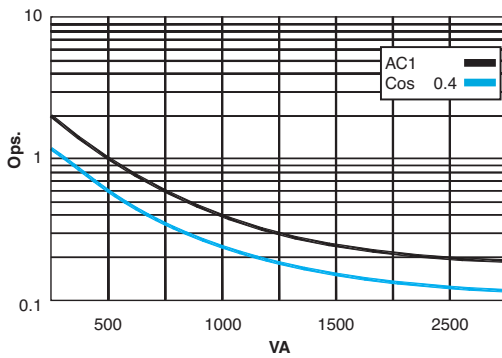
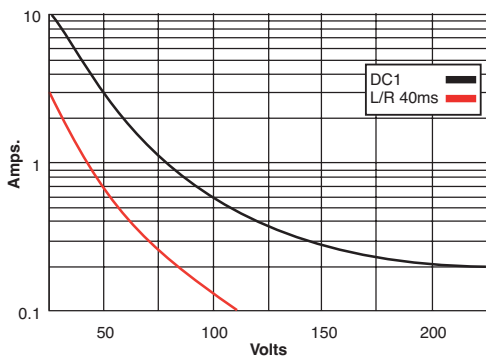
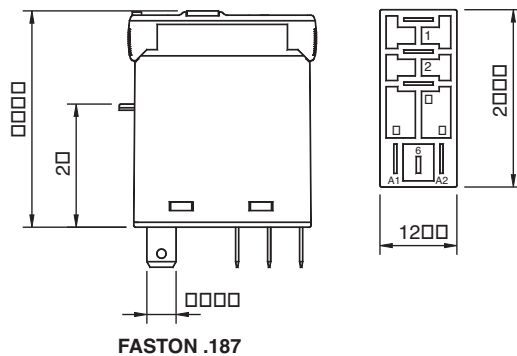

Table 2 Max. DC Load



Dimensions - mm



C10-A10



One pole, change-over contact

10 A 250 V AC1	0.5 A 110 V DC1
10 A 30 V DC1	0.2 A 220 V DC1
13 A 250 V AC1	

Contacts

Materials:	Standard, code 0	AgNi
	Optional, code 8	AgNi + 5µ Au
	Optional, code 5	AgSnO ₂
Max. switching current		10 A
Max. peak inrush current (20 ms)		30 A
Max. switching voltage		250 V
Max. AC load (Table 1)		2.5 KVA
Max. DC load (Table 2)		

Coils (Ohms ±10% @ 20°C)

Pull-in voltage	≤0.8 x U _n
Drop-out voltage	≥0.1 x U _n
Nominal coil power	1.1 VA (AC)/0.7 W (DC)

VAC	Ω	mA	VDC	Ω	mA
24	290	45	12	224	53
48	1,200	23	24	742	32
115	7,300	9.5	48	3,500	13.7
230	28,800	4.7	110	19,900	5.5

Insulation

Dielectric strength (1 minute):	
Open contacts	1,000 V
Between contact and coil	5 KV
Insulation resistance at 500 V	≥1 GΩ
Insulation, IEC 61810-1:	4 KV/3

Specifications

Operate time + bounce time	10 ms
Release time + bounce time	5 ms
Ambient temperature	-40°C (no ice) to +70°C
Mechanical life ops.	10 Mill. AC, 20 Mill. DC relays
Electrical life at nominal load	≥100,000 ops.
Operating frequency at nominal load	1,200/hour
Protection grade	IP 40/RT1
Weight avg.	21 g

Standard Types

AC 50 Hz, (60 Hz): 24, 48, 115, (120), 230, (240)	
X = LED (standard)	C10-A10X VAC
RC suppressor	C10-A10R VAC
DC 12, 24, 48, 110	
X = LED, no polarity (standard)	C10-A10X VDC
Options (DC coils)	
Polarity and free-wheeling diodes	C10-A10FX VDC
AC/DC bridge rectifier (24 or 48 V)	C10-A10BX UC



IEC 61810 EN 60947

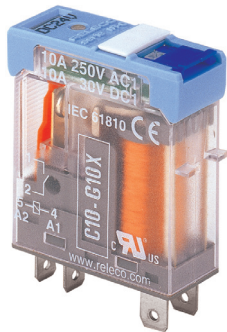

Relay compatible with sockets:

S10, S10-P

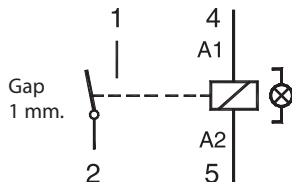

C10-G10



One pole, open contact

10 A 250 V AC1 **0.8 A 110 V DC1**
10 A 30 V DC1 **0.4 A 220 V DC1**

Contacts

Materials: Standard, code 0 AgNi
 Optional, code 8 AgNi + 5μ Au
 Optional, code 5 AgSnO₂
 Max. switching current 10 A
 Max. peak inrush current (20 ms) 30 A
 Max. switching voltage 250 V
 Max. AC load (Table 1) 2.5 KVA
 Max. DC load (Table 2)

Coils (Ohms ±10% @ 20°C)

Pull-in voltage ≤0.8 x U_n
 Drop-out voltage ≥0.1 x U_n
 Nominal coil power 1.1 VA (AC)/0.7 W (DC)

VAC	Ω	mA	VDC	Ω	mA
24	290	45	12	224	53
48	1,200	23	24	742	32
115	7,300	9.5	48	3,500	13.7
230	28,800	4.7	110	19,900	5.5

Table 1 Electrical Life, ops. x 10⁶

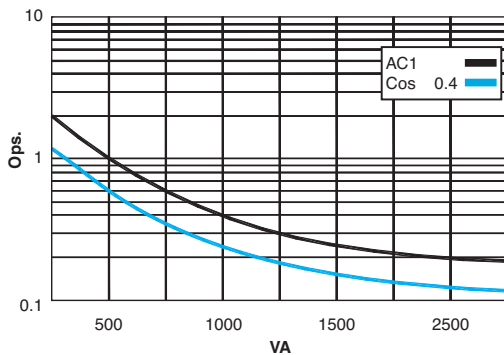
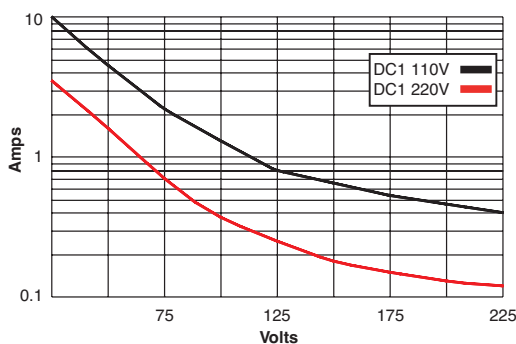

Table 2 Max. DC Load



Insulation

Dielectric strength (1 minute):
 Open contacts 2000 V
 Between contact and coil 5 KV
 Insulation resistance at 500 V ≥1 GΩ
 Insulation, IEC 61810-1: 4 KV/3

Specifications

Operate time + bounce time 10 ms
 Release time + bounce time 8 ms
 Ambient temperature -40°C (no ice) to +70°C
 Mechanical life ops. 10 Mill. AC, 20 Mill. DC relays
 Electrical life at nominal load ≥100,000 ops.
 Operating frequency at nominal load 1,200/hour
 Protection grade IP 40/RT1
 Weight avg. 21 g

Dimensions - mm

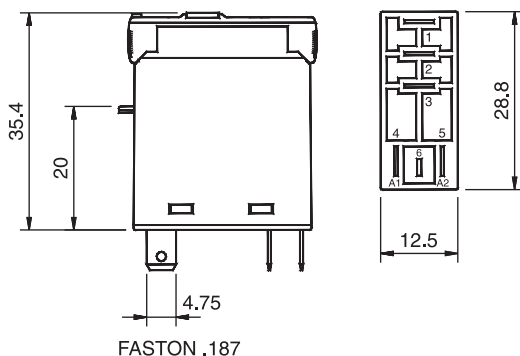

Standard Types

AC 50 Hz, (60 Hz): **24, 48, 115, (120), 230, (240)**
 X = LED (standard) **C10-G10X VAC**
 RC suppressor **C10-G10R VAC**
 DC **12, 24, 48, 110**
 X = LED, no polarity (standard) **C10-G10X VDC**
 Options (DC coils)
 Polarity and free-wheeling diodes **C10-G10FX VDC**
 AC/DC bridge rectifier (24 or 48 V) **C10-G10BX UC**

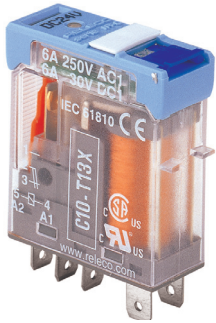

Relay compatible
with sockets:

S10, S10-P

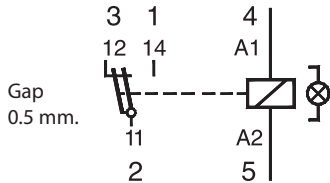

C10-T12



One change-over twin contact

6 A 250 V AC1 **0.5 A 110 V DC1**
6 A 30 V DC1 **0.2 A 220 V DC1**

Contacts

Materials: Standard, code 2 AgNi + 5µ Au
 Max. switching current 6 A
 Max. peak inrush current (20 ms) 15 A
 Max. switching voltage 250 V
 Max. AC load (Table 1) 1.5 KVA
 Max. DC load (Table 2)

Coils (Ohms ±10% @ 20°C)

Pull-in voltage ≤0.8 x U_n
 Drop-out voltage ≥0.1 x U_n
 Nominal coil power 1.1 VA (AC)/0.7 W (DC)

VAC	Ω	mA	VDC	Ω	mA
24	290	45	12	224	53
48	1,200	23	24	742	32
115	7,300	9.5	48	3,500	13.7
230	28,800	4.7	110	19,900	5.5

Table 1 Electrical Life, ops. x 10⁶

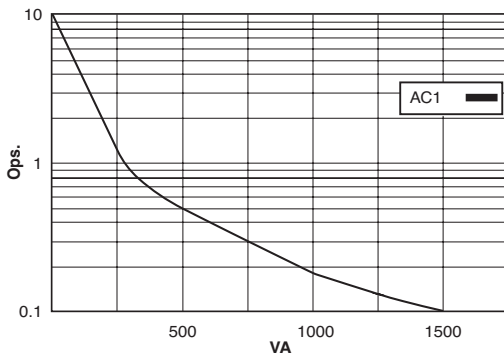
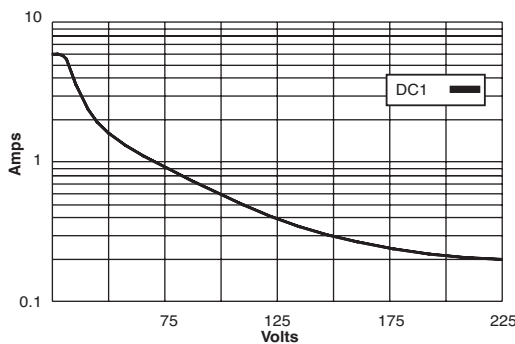

Table 2 Max. DC Load



Insulation

Dielectric strength (1 minute):
 Open contacts 1,000 V
 Between contact and coil 5 KV
 Insulation resistance at 500 V ≥1 GΩ
 Insulation, IEC 61810-1: 4 KV/3

Specifications

Operate time + bounce time 10 ms
 Release time + bounce time 5 ms
 Ambient temperature -40°C (no ice) to +70°C
 Mechanical life ops. 10 Mill. AC relays, 20 Mill. DC relays
 Electrical life at nominal load ≥100,000 ops.
 Operating frequency at nominal load 1,200/hour
 Protection grade IP 40/RT1
 Weight avg. 21 g

Dimensions - mm

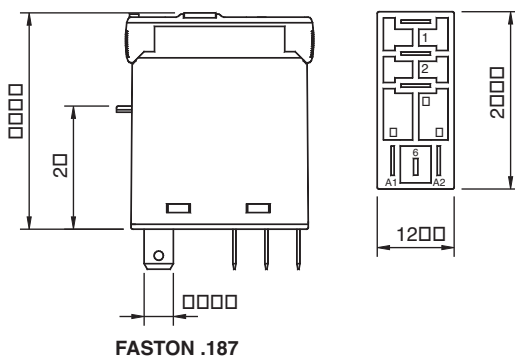

Standard Types

AC 50 Hz, (60 Hz): 24, 48, 115, (120), 230, (240)
 X = LED (standard) **C10-T12X..... VAC**
 RC suppressor **C10-T12R..... VAC**

DC 12, 24, 48, 110
 X = LED, no polarity (standard) **C10-T12X..... VDC**

Options (DC coils)
 Polarity and free-wheeling diodes **C10-T12FX..... VDC**
 AC/DC bridge rectifier (24, 48 or 60V) **C10-T12BX..... UC**



Relay compatible with sockets:

S12, S12-P

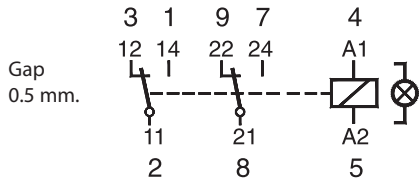

C12-A21



Two poles, change-over contacts

5 A 250 V AC1 **0.5 A 110 V DC1**
5 A 30 V DC1 **0.2 A 220 V DC1**

Contacts

Materials: Standard, code 1 AgNi + 0.2μ Au
 Optional, code 2 AgNi + 5μ Au
 Max. switching current 5 A
 Max. peak inrush current (20 ms) 15 A
 Max. switching voltage 250 V
 Max. AC load (Table 1) 1.2 KVA
 Max. DC load (Table 2)

Table 1 Electrical Life, ops. x 10⁶

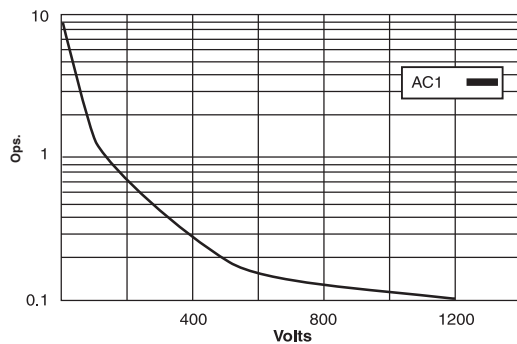

Coils (Ohms ±10% @ 20°C)

Pull-in voltage ≤0.8 x U_n
 Drop-out voltage ≥0.1 x U_n
 Nominal coil power 1.1 VA (AC)/0.7 W (DC)

VAC	Ω	mA	VDC	Ω	mA
24	290	45	12	224	53
48	1,200	23	24	742	32
115	7,300	9.5	48	3,500	13.7
230	28,800	4.7	110	19,900	5.5

Table 2 Max. DC Load

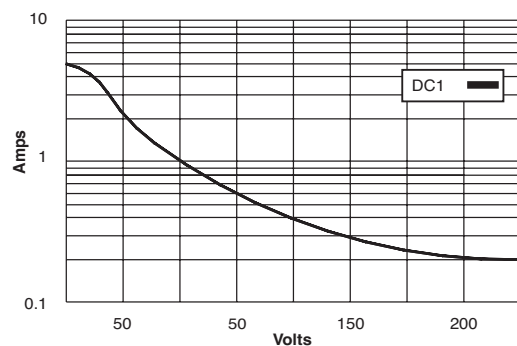

Insulation

Dielectric strength (1 minute):
 Open contacts 1,000 V
 Between adjacents poles 3,000 V
 Between contact and coil 5 KV
 Insulation resistance at 500 V ≥1 GΩ
 Insulation, IEC 61810-1: 4 KV/3

Specifications

Operate time + bounce time 10 ms
 Release time + bounce time 5 ms
 Ambient temperature -40°C (no ice) to +60°C
 Mechanical life ops. 10 Mill. AC relays, 20 Mill. DC relays
 tElectrical life at nominal load ≥100,000 ops.
 Operating frequency at nominal load 1,200/hour
 Protection degree IP 40/RT1
 Weight avg. 21 g

Dimensions - mm

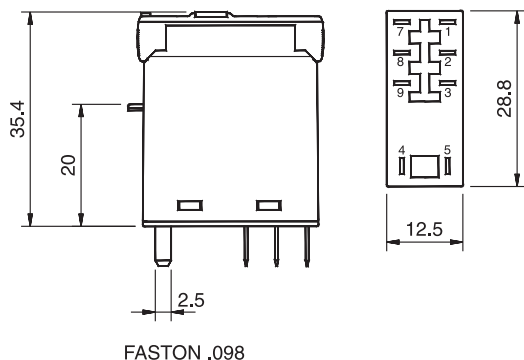

Standard Types

AC 50 Hz, (60 Hz): 24, 48, 115, (120), 230, (240)
X = LED (standard) **C12-A21X VAC**
RC suppressor **C12-A21R VAC**
DC 12, 24, 48, 110
X = LED, no polarity (standard) **C12-A21XVDC**
Options (DC coils)
 Polarity and free-wheeling diodes **C12-A21FXVDC**
 AC/DC bridge rectifier (24, 48 or 60 V) **C12-A21BX UC**

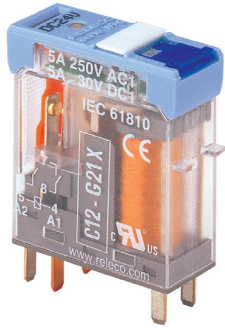

Relay compatible with sockets:

S12, S12-P

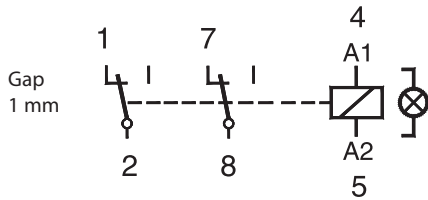

Table 1 Electrical Life, ops. x 10⁶

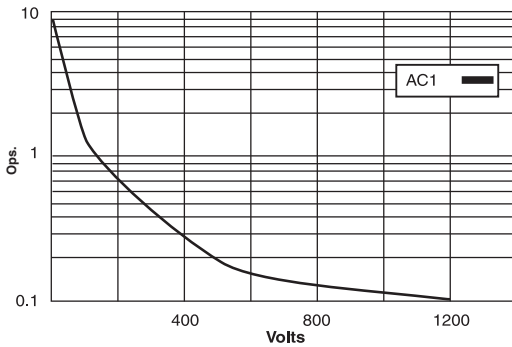
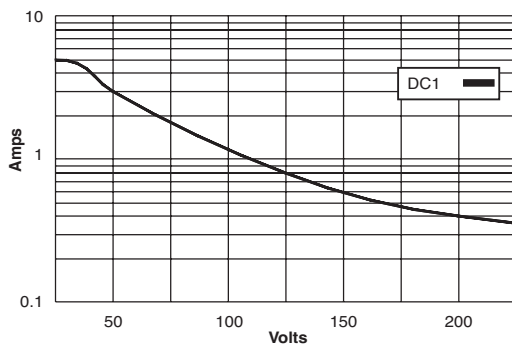
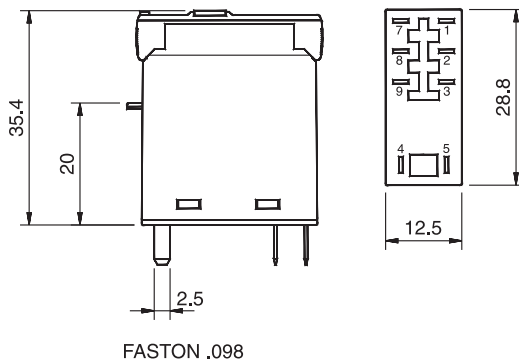

Table 2 Max. DC Load



Dimensions - mm



C12-G21



Two poles, open contacts

5 A	250 V AC1	0.8 A 110 V DC1
5 A	30 V DC1	0.4 A 220 V DC1

Contacts

Materials:	Standard, code 1	AgNi + 0.2µ Au
	Optional, code 2	AgNi + 5µ Au
Max. switching current		5 A
Max. peak inrush current (20 ms)		15 A
Max. switching voltage		250 V
Max. AC load (Table 1)		1.2 KVA
Max. DC load (Table 2)		

Coils (Ohms ±10% @ 20°C)

Pull-in voltage	≤0.8 x U _n
Drop-out voltage	≥0.1 x U _n
Nominal coil power	1.1 VA (AC)/0.7 W (DC)

VAC	Ω	mA	VDC	Ω	mA
24	290	45	12	224	53
48	1,200	23	24	742	32
115	7,300	9.5	48	3,500	13.7
230	28,800	4.7	110	19,900	5.5

Insulation

Dielectric strength (1 minute):	
Open contacts	2,000 V
Between adjacent poles	3,000 V
Between contact and coil	5 KV
Insulation resistance at 500 V	≥1 GΩ
Insulation, IEC 61810-1:	4 KV/3

Specifications

Operate time + bounce time	10 ms
Release time + bounce time	5 ms
Ambient temperature	-40°C (no ice) to +60°C
Mechanical life ops.	10 Mill. AC, 20 Mill. DC relays
Electrical life at nominal load	≥100,000 ops.
Operating frequency at nominal load	1,200/hour
Protection grade	IP 40/RT1
Weight avg.	21 g

Standard Types

AC 50 Hz, (60 Hz): 24, 48, 115, (120), 230, (240)	
X = LED (standard)	C12-G21X VAC
RC suppressor	C12-G21R VAC
DC 12, 24, 48, 110	
X = LED, no polarity (standard)	C12-G21X VDC
Options (DC coils)	
Polarity and free-wheeling diodes	C12-G21FX VDC
AC/DC bridge rectifier (24, 48 or 60V)	C12-G21BX UC

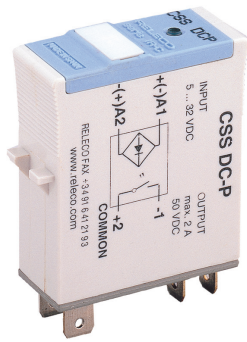

Relay compatible with sockets:
S10, S10-M, S10-P, S-10K

CSS-DCP



Solid state relay, PNP

DC inductive or resistive load switching
Positive common output

One open contact

2 A @ 5-50 VDC

CSS-DCP

Diagram

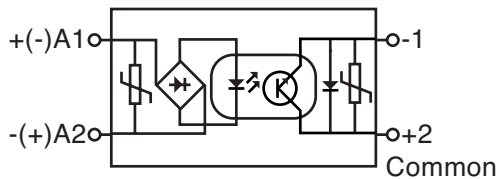

Input, Polarity Protected

Range of input voltage	5-32 VDC
Drop-out voltage	<2.5 VDC
Input current	3 ±1 mA
Current stabilizer	Yes
Peak inrush voltage protection	IEC-1000-4-5 Level 1

Output, Positive Common

Max. output current	2 A
Max. output voltage	50 VDC
Minimum output voltage	5 VDC
Max. drop voltage	1.3 VDC
Max. leakage current at 48 VDC	<100 µA
Max. overcurrent pulse	5 A, 350 µs
Pulse protection	IEC-1000-4-5 Level 1
Max. current at inverse voltage	1 A

Max. DC Load vs. Ambient Temperature

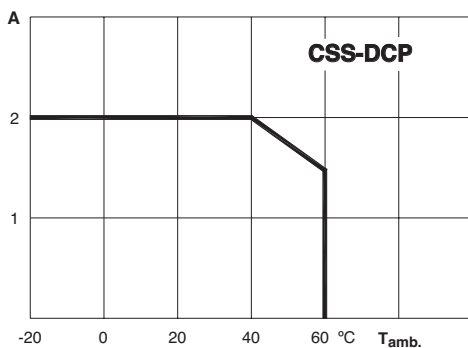

Specifications

Dielectric strength input / output	4 KV/1 min.
Operate time	1 ms
Release time, max.	2 ms
Working temperature, max.	60°C
Storage temperature	80°C
Weight avg.	28 g

Applications

To switch up to 50 VDC, heating elements electrovalves, motors, input/output signals on PLC's, solenoids, incandescent and fluorescent lamps, etc.

Inductive loads must be shunted with an antiparallel diode.

Dimensions - mm

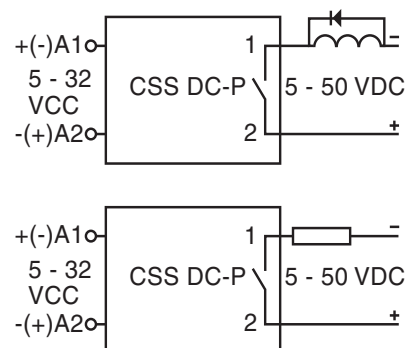
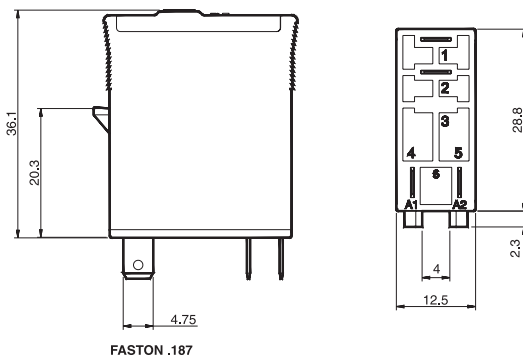

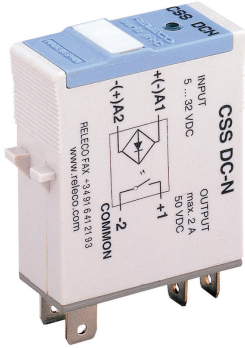

Relay compatible with sockets:
S10, S10-P

CSS-DCN



Solid state relay, NPN

DC inductive or resistive load switching
Negative common output

One open contact

2 A @ 5-50 VDC

Input, Polarity Protected

Range of input voltage	5-32 VDC
Drop-out voltage	<2.5 VDC
Input current	3 ±1 mA
Current stabilizer	Yes
Peak inrush voltage protection	IEC-1000-4-5 Level 1

Output, Positive Common

Max. output current	2 A
Max. output voltage	50 VDC
Minimum output voltage	5 VDC
Max. drop voltage	1.3 VDC
Max. leakage current at 48 VDC	<100 µA
Max. overcurrent pulse	5 A, 350 µs
Pulse protection	IEC-1000-4-5 Level 1
Max. current at inverse voltage	1 A

CSS-DCN Diagram

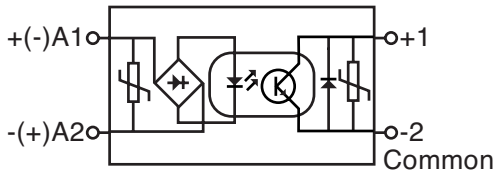

Max. DC Load vs. Ambient Temperature

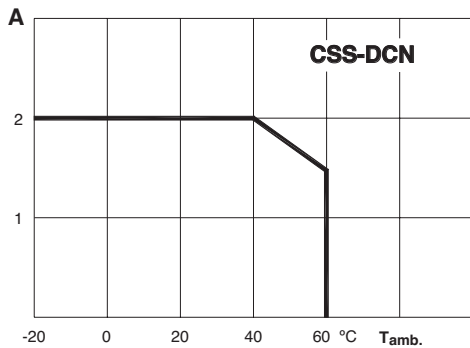

Specifications

Dielectric strength input / output	4 KV/1 min
Operate time	1 ms
Release time, max.	2 ms
Working temperature, max.	60°C
Storage temperature	80°C
Weight avg.	28 g

Applications

To switch, up to 50 VDC, heating elements electrovalves, motors, input/output signals on PLC's, solenoids, incandescent and fluorescent lamps, etc.

Inductive loads must be shunted with an antiparallel diode.

Dimensions - mm

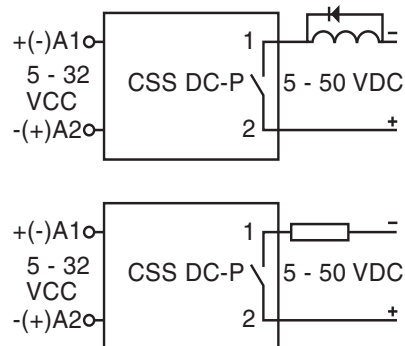
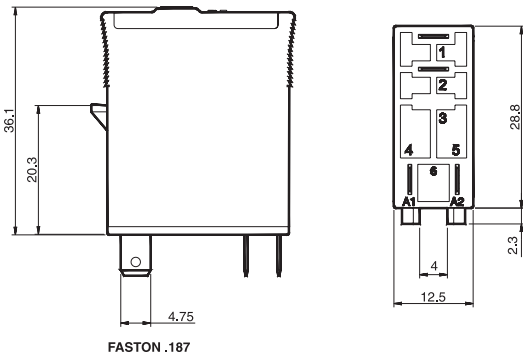



Relay compatible with sockets:
S10, S10-P

CSS-AC



Solid state relay
AC inductive loads switching

One open contact

3 A @ 24-250 VAC, 50/60 Hz

Input, Polarity Protected

Range of input voltage	5-32 VDC
Drop-out voltage	<2.5 VDC
Input current	5-15 mA
Current stabilizer	Yes
Peak inrush voltage protection	IEC-1000-4-5 Level 1

Output, Instantaneous

Max. output current	3 A
Minimum output current	50 mA
Max. output voltage	250 VAC
Minimum output voltage	24 VAC
Max. drop voltage	<1.5 VAC
Max. leakage current	0.55 mA
Max. Dv/dt	500 V/μs
I ² t for 10 ms. fuse	50 A2/s

CSS-AC

Diagram

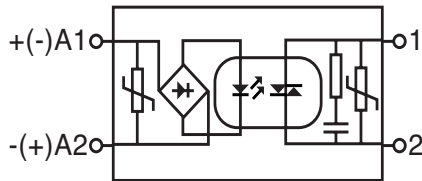

Max. AC Load vs. Ambient Temperature

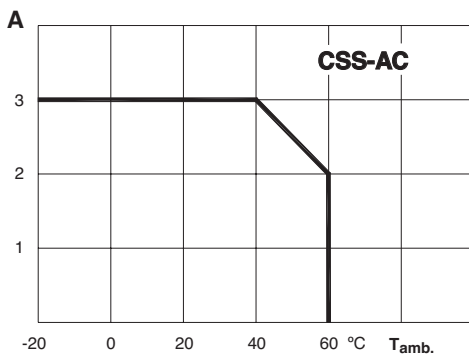

Specifications

Dielectric strength input/output	4 KV/1min.
Operate time	1/2 cycle
Release time	2 ms + 1/2 cycle
Working temperature, max.	60°C
Storage temperature, max.	80°C
Weight avg.	28 g

Applications

Suitable to switch inductive loads up to 3 A/250 VAC.

In switching loads with a high inrush or overcurrent (max. Di/dt 50 A/μs) such as transformers, motors or fluorescents, the maximum output current limit is 2 A.

Dimensions - mm

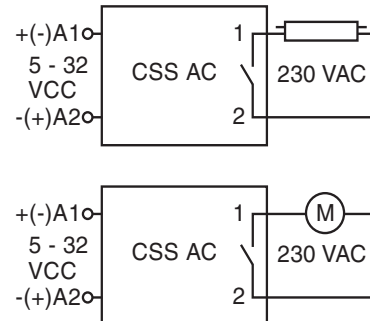
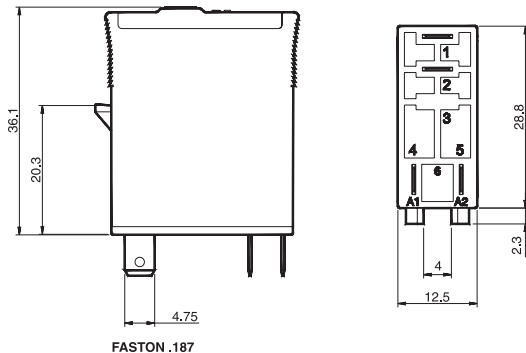

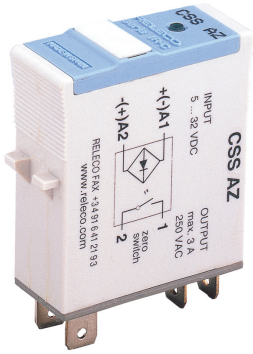

Relay compatible with sockets:
S10, S10-P

CSS-AZ



Solid state relay
AC resistive loads switching

One open contact

3 A @ 24-250 VAC, 50/60 Hz

Input, Polarity Protected

Range of input voltage	5-32 VDC
Drop-out voltage	<2.5 VDC
Input current	5-15 mA
Current stabilizer	Yes
Peak inrush voltage protection	IEC-1000-4-5 Level 1

Output, Synchronized to Zero

Max. output current	3 A
Minimum output current	50 mA
Max. output voltage	250 VAC
Minimum output voltage	24 VAC
Max. drop voltage	<1.5 VAC
Max. leakage current	0.55 mA
Max. Dv/dt	500 V/μs
I ² t for 10 ms. fuse	50 A ² /s

CSS-AZ

Diagram

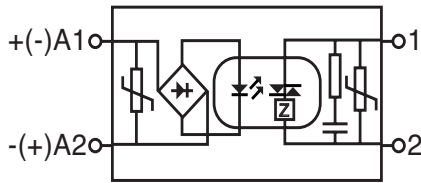

Max. DC Load vs. Ambient Temperature

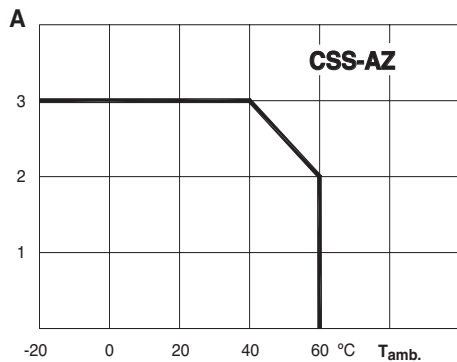

Dimensions - mm

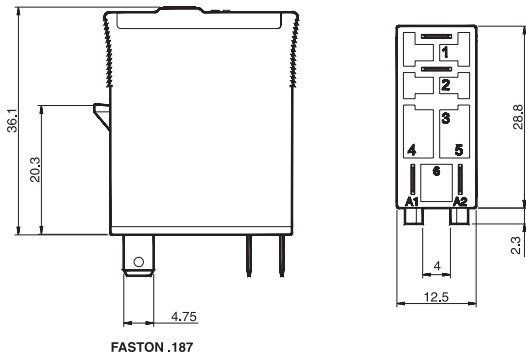

Specifications

Dielectric strength input/output	4 KV/1min.
Operate time	1/2 cycle
Release time	2 ms + 1/2 cycle
Working temperature, max.	60°C
Storage temperature, max.	80°C
Weight avg.	28 g

Applications

Switches AC resistive loads up to 3 A/250 VAC in the zero point of the tension and avoids any overcurrent peak in the connection.

Suitable to switch resistors, incandescent lamps, signalling, etc.

Not suitable for inductive loads.

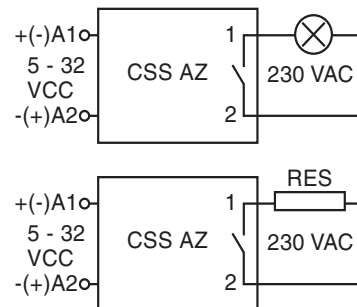

Notes:

SOCKETS

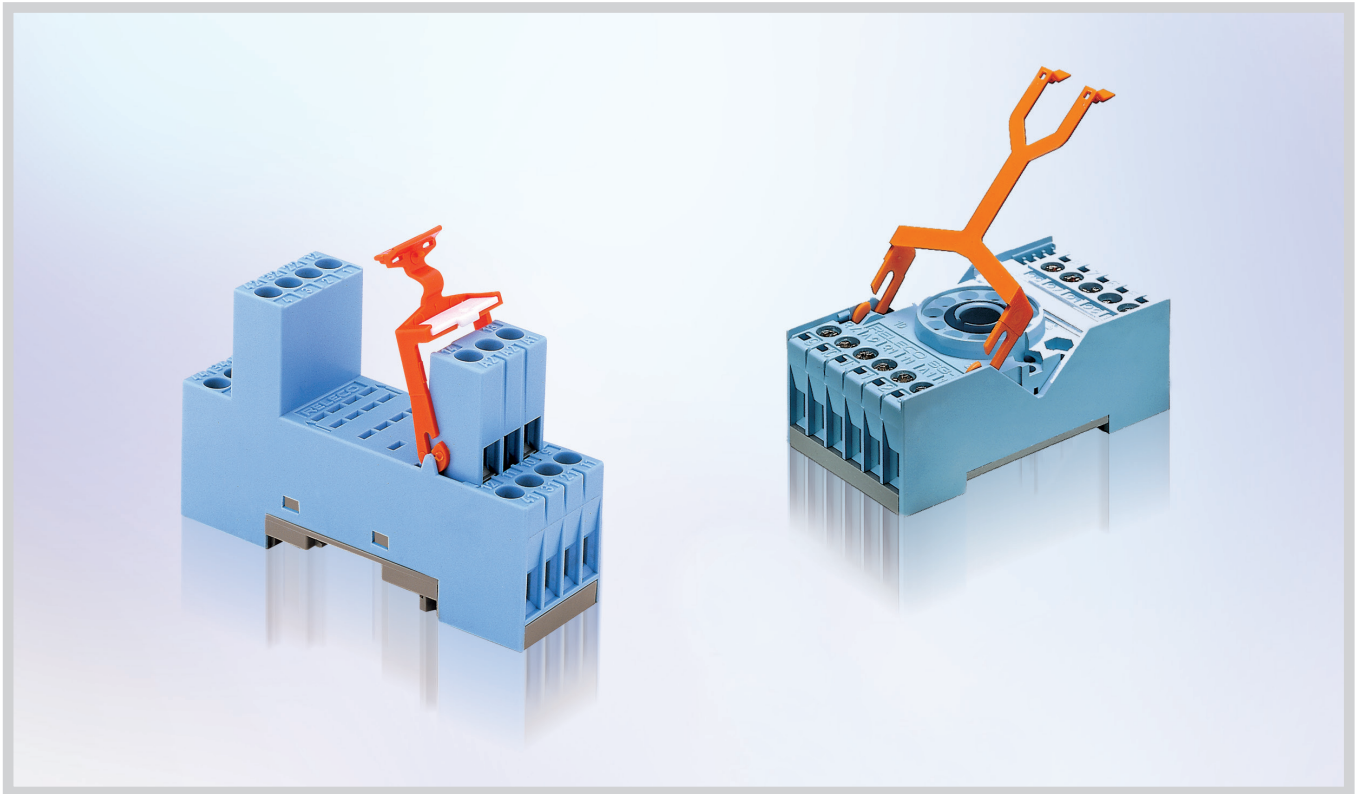



S2-B



Two pole, one level, coding ring
Integrated clip and marking label

10 A 300 V

Socket for MRC, 8-Pin Plug-In Relay Types C2-A2, C2-G2, C2-T2

- Accepts the exclusive RELECO coding ring for coding both relay and socket
- DIN rail or panel mountable
- Removable label
- EN/DIN and sequential numbering

According to EN 60947-1 and IEC 61810-5

Wiring Diagram

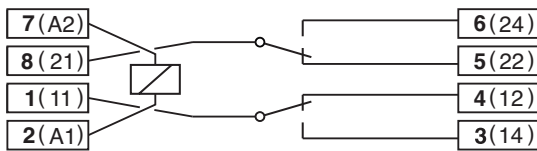

Dimensions - mm

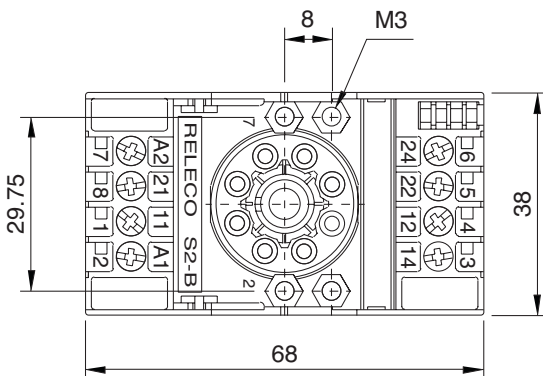
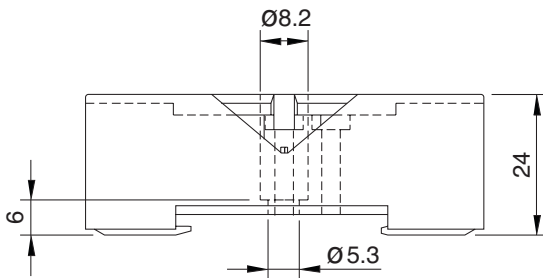

Specifications

Nominal Load: 10 A/300 V

Insulation:

Dielectric strength, 1 minute	
Between contacts and coil	2.5 KV
Between all terminals and rail DIN	2.5 KV
Between adjacent poles	2.5 KV

Wire In-Lets Capacity:

Solid wire	4 mm ² or 2 x 2.25 mm ²
Multi-core	22-14 AWG
Ferrule tip terminals	4 mm ²
Max. screw torque	1.2 Nm
Screw dimensions	M3, Pozi
Integrated hold-down clip	
Removable marking label	





S2-L 2-Pole Flange Panel Mountable

S2-PO 2-Pole Printed Circuit with Flange

S3-L 3-Pole Flange Panel Mountable

S3-PO 3-Pole Printed Circuit with Flange

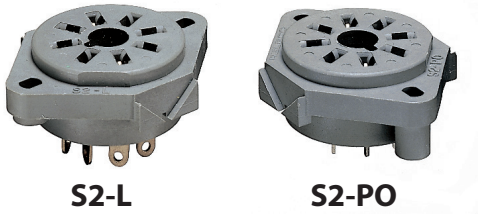

S2-L

S2-PO

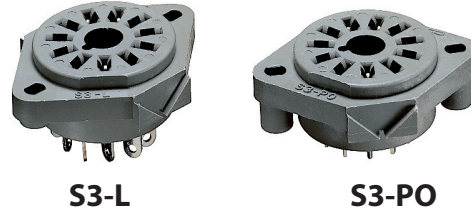

S3-L

S3-PO

Specifications

Nominal Load 10 A/300 V
Dielectric Strength Adjacent Pin 2.5 KV

Specifications

Nominal Load 10 A/250 V
Dielectric Strength Adjacent Pin 2.5 KV

Printed Circuit Lay-Out

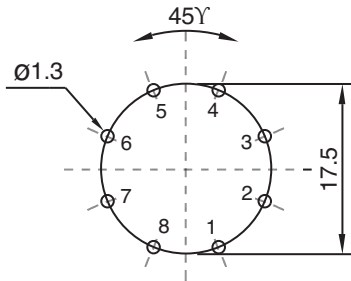

Printed Circuit Lay-Out

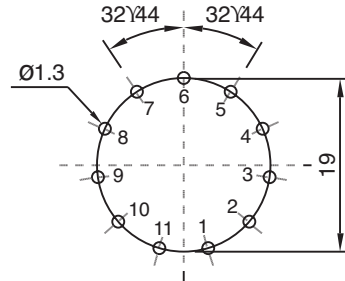

Dimensions - mm

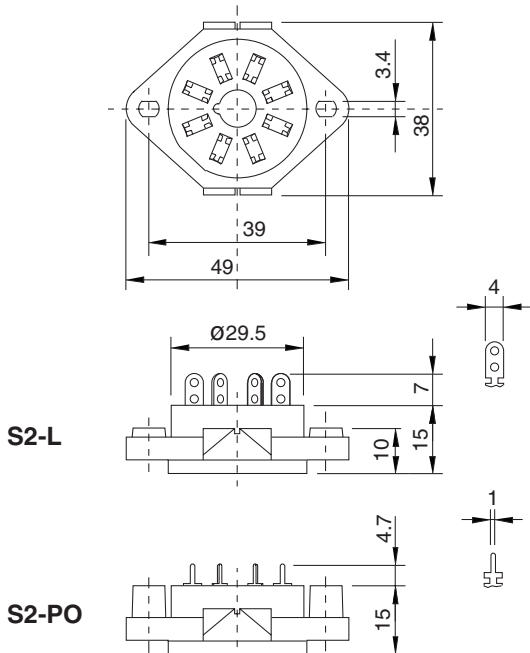

Dimensions - mm

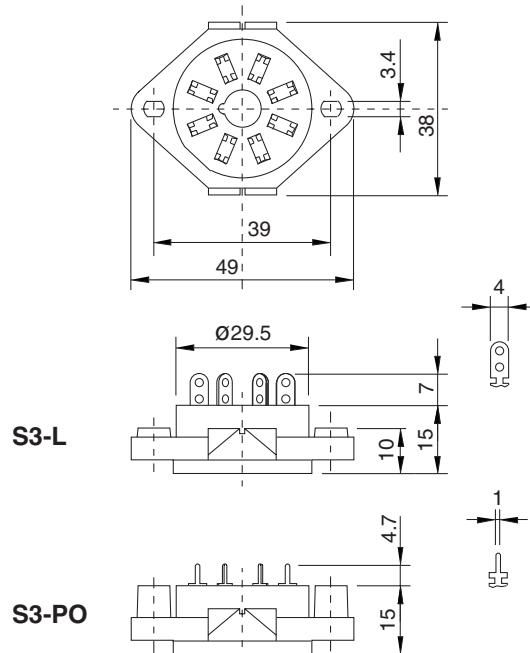

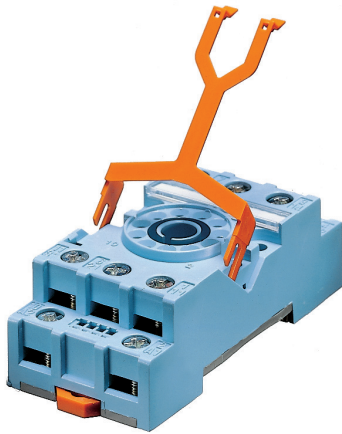

S3-S



Three pole, two level, coding ring
Integrated clip and marking label

10 A 250 V

Socket for MRC, 11-Pin Plug-In Relay Types
C3-A3, C3-G3, C3-T3, C3-X1, C3-M1, C3-R2,
C3-E2, C3-N3

- Accepts the exclusive RELECO coding ring for coding both relay and socket.
- DIN rail or panel mountable
- EN/DIN and sequential numbering

According to EN 60947-1 and IEC 61810-5

Wiring Diagram

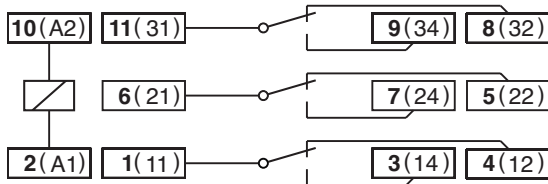

Dimensions - mm

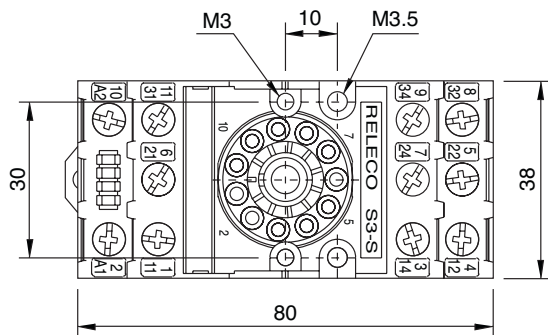
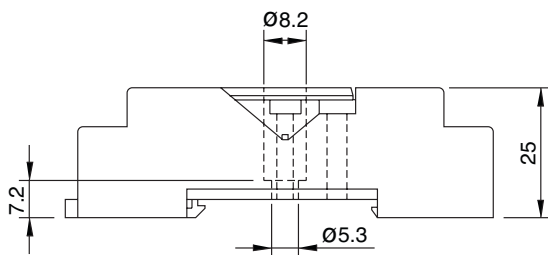

Specifications

Nominal Load: 10 A/250 V

Insulation:

Dielectric strength, 1 minute	
Between contacts and coil	2.5 KV
Between all terminals and rail DIN	2.5 KV
Between adjacent poles	2.5 KV

Wire In-Lets Capacity:

Solid wire	4 mm ² or 2 x 2.5 mm ²
Multi-core	22-14 AWG
Ferrule tip terminals	4 mm ²
Max. screw torque	1.2 Nm
Screw dimensions	M3, Pozi
Integrated hold-down clip	
Removable marking label	



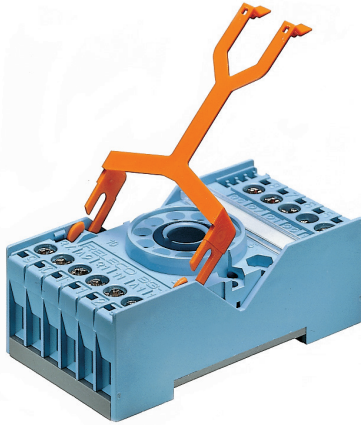

S3-B



Three pole, one level, coding ring
Integrated clip and marking label

10 A 250 V

Socket for MRC, 11-Pin Plug-In Relays Types
C3-A3, C3-G3, C3-T3, C3-X1, C3-M1, C3-R2,
C3-E2, C3-N3

- Accepts the exclusive RELECO coding ring for coding both relay and socket.
- DIN rail or panel mountable
- Removable label
- EN/DIN and sequential numbering

According to EN 60947-1 and IEC 61810-1

Wiring Diagram

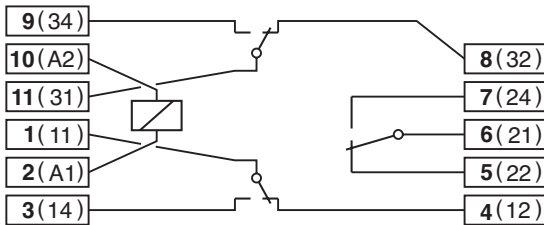

Dimensions - mm

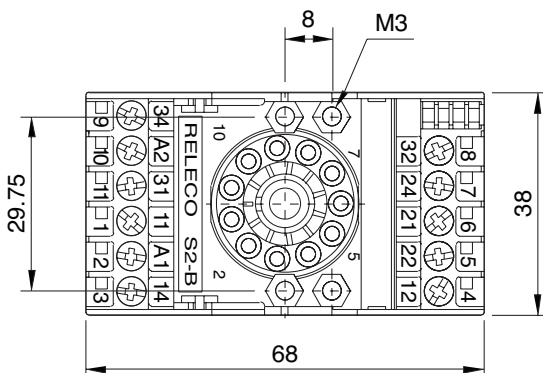
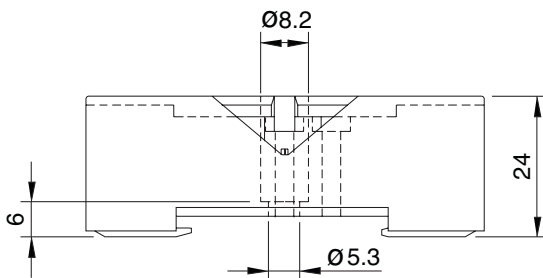

Specifications

Nominal Load: 10 A/250 V

Insulation:

Dielectric strength, 1 minute	
Between contacts and coil	2.5 KV
Between all terminals and rail DIN	2.5 KV
Between adjacent poles	2.5 KV

Wire In-Lets Capacity:

Solid wire	4 mm ² or 2 x 2.5 mm ²
Multi-core	22-14 AWG
Ferrule tip terminals	4 mm ²
Max. screw torque	1.2 Nm
Screw dimensions	M3, Pozi
Integrated hold-down clip	
Removable marking label	



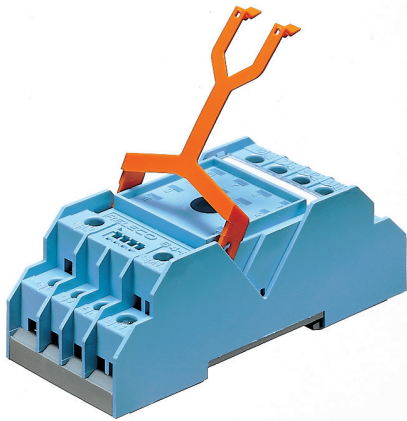

S4-J



Four pole, two level, logic wiring
Integrated clip and marking label

10 A 250 V

Socket for MRC, 14-Pin Plug-In Relay Types C4-A4, C4-X2, C4-R3

- DIN rail or panel mountable
- Removable label
- EN/DIN and sequential numbering

According to EN 60947 + EN 61810

Wiring Diagram

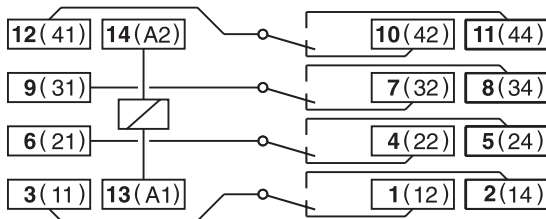

Dimensions - mm

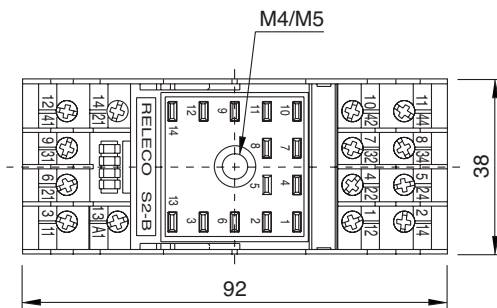
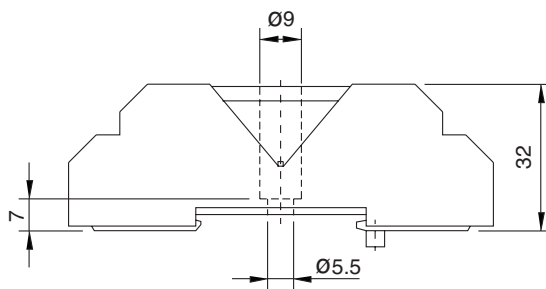

Specifications

Nominal Load: 10 A/250 V

Insulation:

Dielectric strength, 1 minute	
Between contacts and coil	2.5 KV
Between all terminals and rail DIN	2.5 KV
Between adjacent poles	2.5 KV

Wire In-Lets Capacity:

Solid wire	4 mm ² or 2 x 2.5 mm ²
Multi-core	24-14 AWG
Ferrule tip terminals	4 mm ²
Max. screw torque	1.2 Nm
Screw dimensions	M3, Pozi
Integrated hold-down clip	
Removable marking label	



S4-L 4-Pole Flange Panel Mountable

S4-PO 4-Pole Printed Circuit with Flange

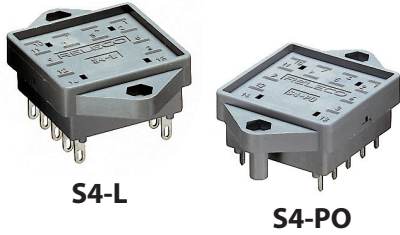

S5-L 3-Pole Flange Panel Mountable **CE**

S5-P 3-Pole Printed Circuit

S5-PO 3-Pole Printed Circuit with Flange



Specifications

Nominal Load 10 A/250 V
Dielectric Strength Adjacent Pin 2.5 KV

Specifications

Nominal Load 16 A/400 V
Dielectric Strength Adjacent Pin 4 KV

Printed Circuit Lay-Out

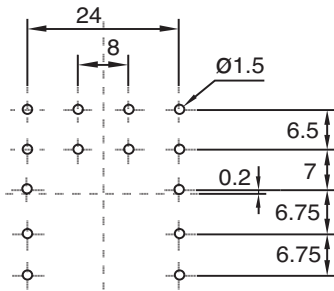

Printed Circuit Lay-Out

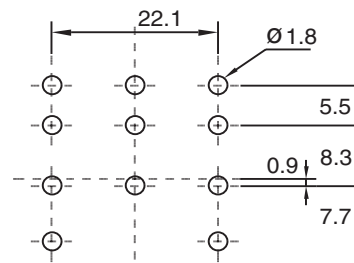

Dimensions - mm

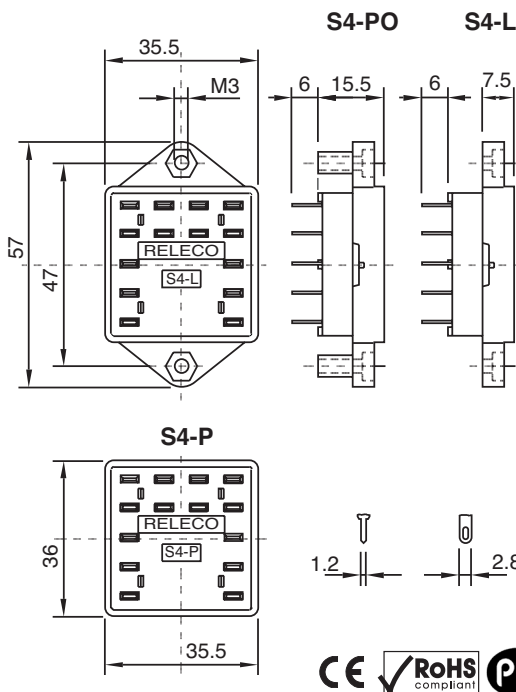

Dimensions - mm

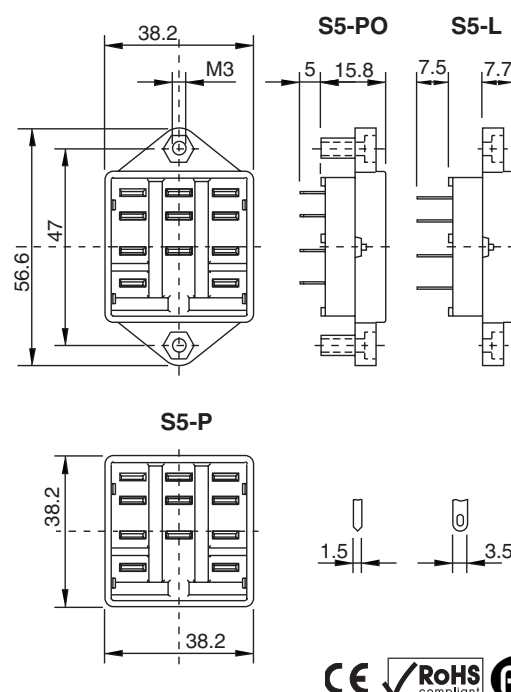

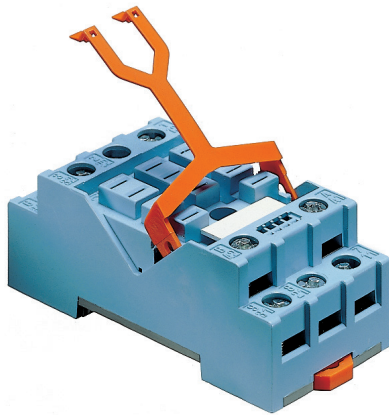

S5-S



Three pole, two level, logic wiring
Integrated clip and marking label

16 A 400 V

Socket for MRC, 11-Pin Plug-In Relay Types C5-A, C5-G3, C5-X1, C5-M1, C5-M2, C5-R2

- DIN rail or panel mountable
- Removable label
- EN/DIN and sequential numbering

According to EN 60947-1 and IEC 61810-5

Wiring Diagram

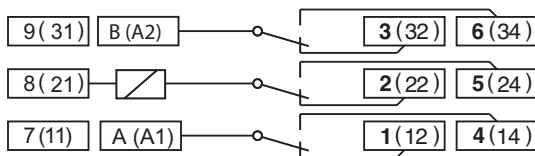

Dimensions - mm

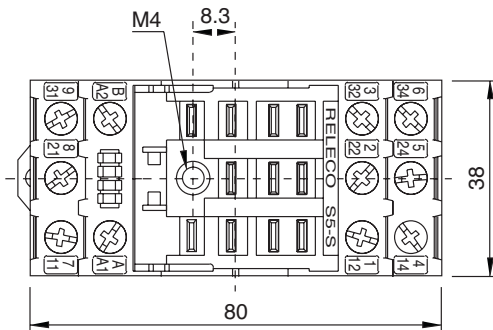
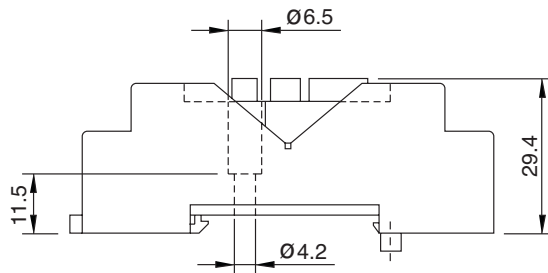

Specifications

Nominal Load: 16 A/400 V

Insulation:

Dielectric strength, 1 minute	
Between contacts and coil	4 KV
Between all terminals and rail DIN	4 KV
Between adjacent poles	4 KV

Wire In-Lets Capacity:

Solid wire	4 mm ² or 2 x 2.5 mm ²
Multi-core	22-14 AWG
Ferrule tip terminals	4 mm ²
Max. screw torque	1.2 Nm
Screw dimensions	M3, Pozi
Integrated hold-down clip	
Removable marking label	



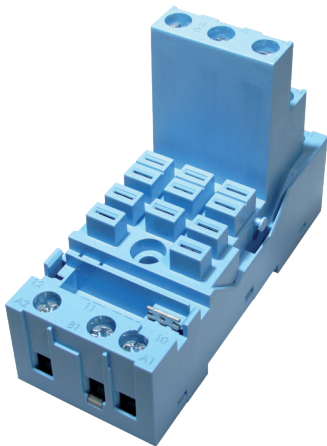

S5-M

Three pole, three level, logic wiring
Integrated clip and marking label

16 A 400 V

**Socket for MRC, 11-Pin Plug-In Relay Types
C5-A2, C5-A3, C5-G3, C5-X1, C5-M1, C5-M2,
C5-R2**

- DIN rail or panel mountable
- Removable label
- EN/DIN and sequential numbering

Wiring Diagram

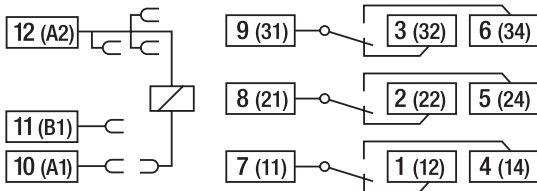

Dimensions - mm

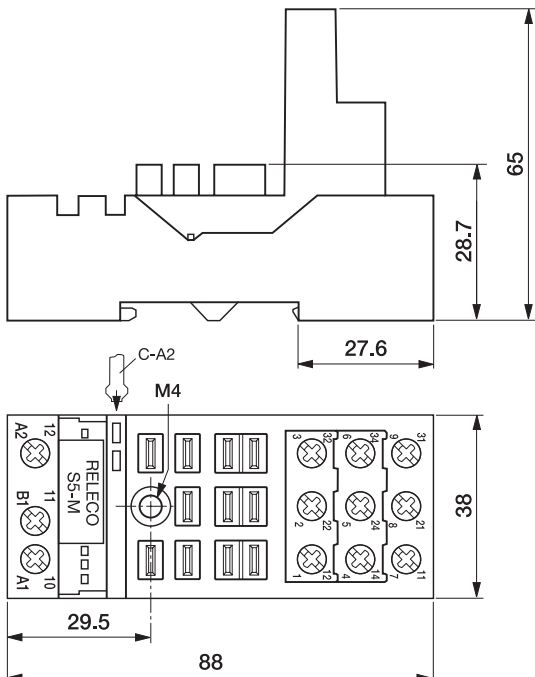

Specifications

Nominal Load: 16 A/400 V

Insulation:

Dielectric strength, 1 minute	
Between contacts and coil	4 KV
Between all terminals and rail DIN	4 KV
Between adjacent poles	4 KV

Wire In-Lets Capacity:

Solid wire	6 mm ² or 2 x 2.5 mm ²
Multi-core	10, 16 AWG
Ferrule tip terminals	4 mm ²
Max. screw torque	1.2 Nm
Screw dimensions	M3.5, Pozi
Integrated hold-down clip	
Removable marking label	



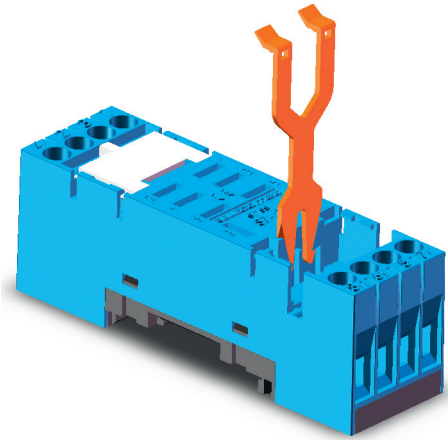

S7-C

Two pole, one level
Integrated clip and marking label

10 A

Socket for QRC, 2-Pole Plug-In Relay Types C7-A2, C7-T2, C7-G2, C7-X1, C7-W1

- DIN rail or panel mountable
- Removable label
- EN/DIN and sequential numbering
- Bridge bar connection in A2

Wiring Diagram

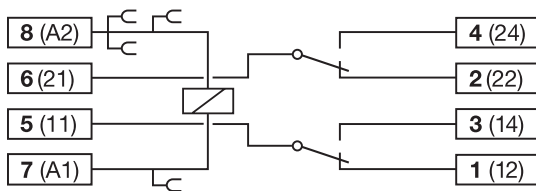

Dimensions - mm

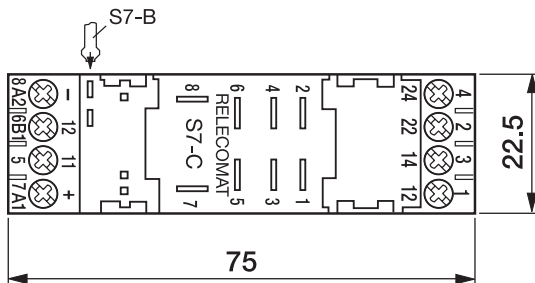
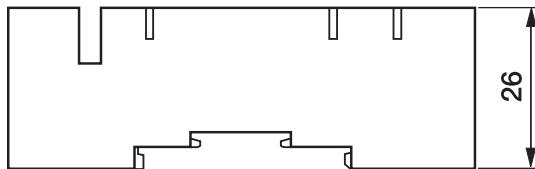

Specifications

Nominal Load: 10 A

Insulation:

Dielectric strength, 1 minute	
Between contacts and coil	2.5 KV
Between all terminals and rail DIN	2.5 KV
Between adjacent poles	2.5 KV

Wire In-Lets Capacity:

Solid wire	4 mm ² or 2 x 1.5 mm ²
Multi-core	16, 18 AWG
Ferrule tip terminals	4 mm ²
Max. screw torque	0.7 Nm
Screw dimensions	M3, Pozi
Integrated hold-down clip	
Removable marking label	



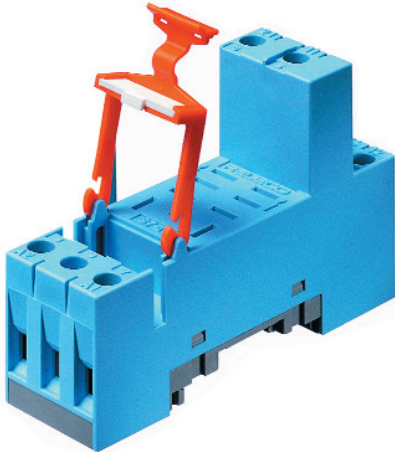

S7-I/O



Two pole, two level
Integrated clip and marking label

10 A 250 V

Socket for QRC, 2-Pole Plug-In Relay Types C7-A2, C7-T, C7-6, C7-X, C7-W

- DIN rail or panel mountable
- Removable label
- EN/DIN and sequential numbering

According to EN 60947-1 and IEC 61810-5

Wiring Diagram

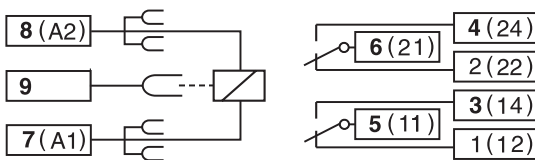

Dimensions - mm

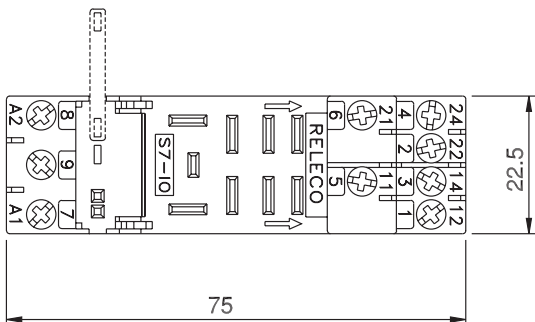
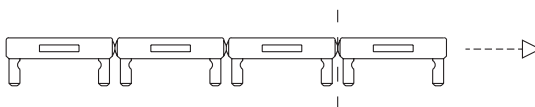
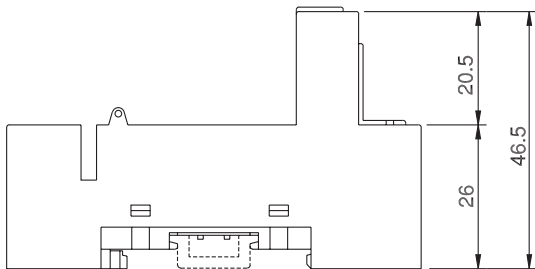

Specifications

Nominal Load: 10 A/250 V

Insulation:

Dielectric strength, 1 minute	
Between contacts and coil	2.5 KV
Between all terminals and rail DIN	2.5 KV
Between adjacent poles	2.5 KV

Wire In-Lets Capacity:

Solid wire	4 mm ² or 2 x 2.5 mm ²
Multi-core	22-14 AWG
Ferrule tip terminals	4 mm ²
Max. screw torque	1.2 Nm
Screw dimensions	M3, Pozi
Integrated hold-down clip	
Removable marking label	



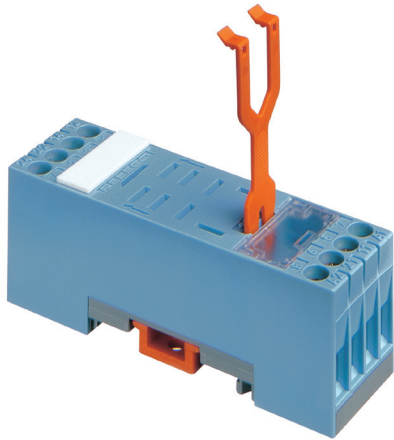

S7-16



One pole, one level
Integrated clip and marking label

16 A 250 V

Socket for MRC, 1-Pole Plug-In Relay Types C7-A10

- DIN rail or panel mountable
- Removable label
- EN/DIN and sequential numbering

According to EN 60947-1 and IEC 61810-5

Wiring Diagram

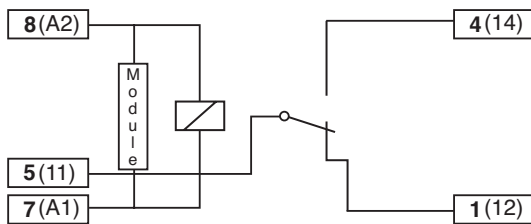

Dimensions - mm

S7-16 for use with C7-A10 (16A)

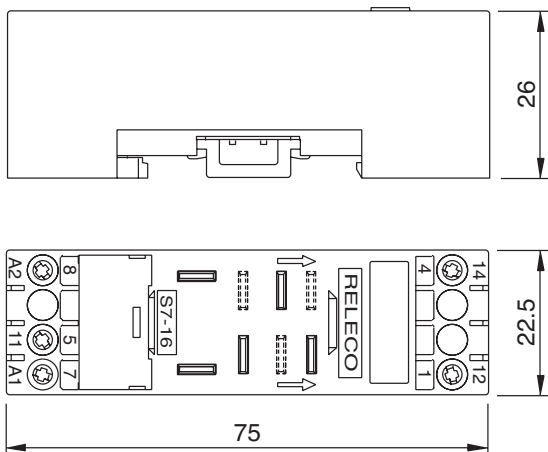

Specifications

Nominal Load: 16 A/250 V

Insulation:

Dielectric strength, 1 minute	
Between contacts and coil	2.5 KV
Between all terminals and rail DIN	2.5 KV
Between adjacent poles	2.5 KV

Wire In-Lets Capacity:

Solid wire	4 mm ² or 2 x 2.5 mm ²
Multi-core	22-14 AWG
Ferrule tip terminals	4 mm ²
Max. screw torque	1.2 Nm
Screw dimensions	M3, Pozi
Integrated hold-down clip	
Removable marking label	





S7-P 2-Pole Printed Circuit

S7-PO 2-Pole Printed Circuit with Flange

S9-P 4-Pole Printed Circuit

S9-PO 4-Pole Printed Circuit with Flange

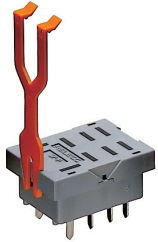

S7-P



S7-PO



S9-PO



S9-P

Specifications

Nominal Load 10 A/250 V
Dielectric Strength Adjacent Pin 2.5 KV

Specifications

Nominal Load 6 A/250 V
Dielectric Strength Adjacent Pin 2.5 KV

Printed Circuit Lay-Out

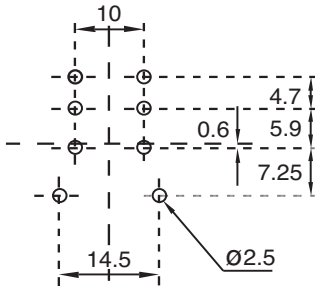

Printed Circuit Lay-Out

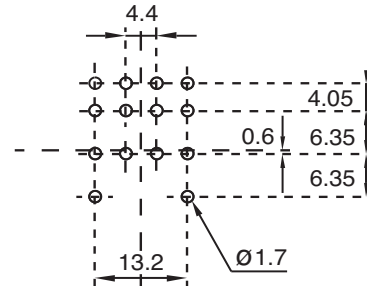

Dimensions - mm

S7-PO

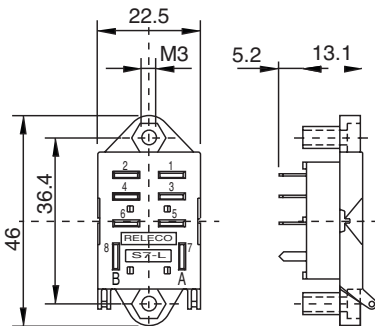

S9-PO

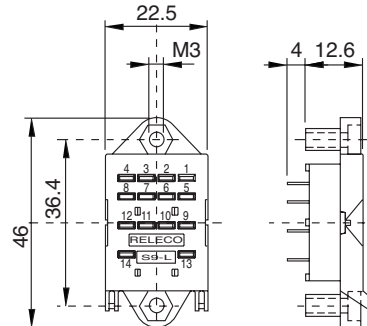

S7-P

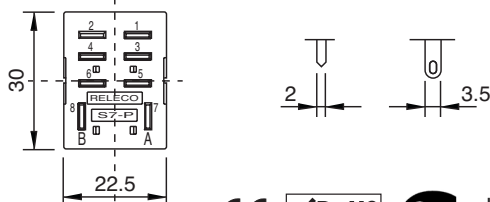

S9-P

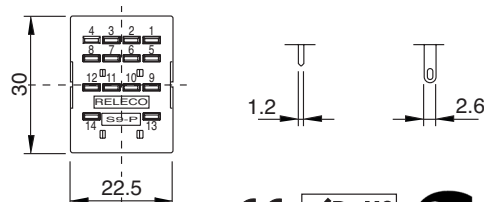

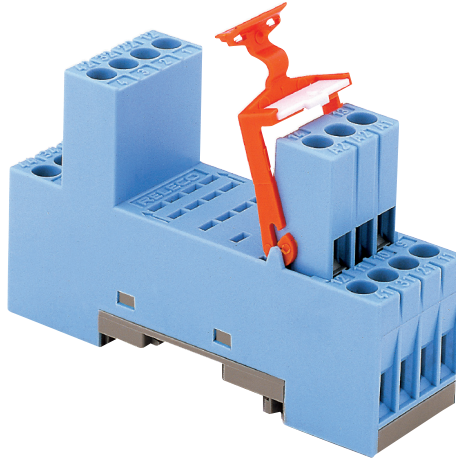

S9-M



Four pole, two level
Integrated clip and marking label

6 A 250 V

Socket for QRC, 4-Pole Plug-In Relay Types C9-A4, C9-E2, C9-R2

- DIN rail or panel mountable
- EN/DIN and sequential numbering

According to EN 60947-1 and IEC 61810-1

Wiring Diagram

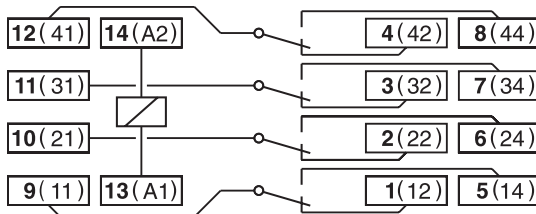

Dimensions - mm

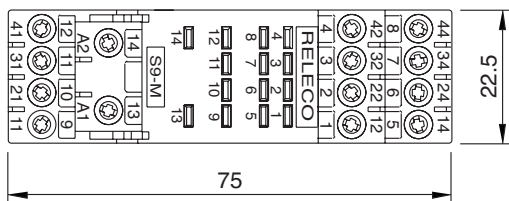
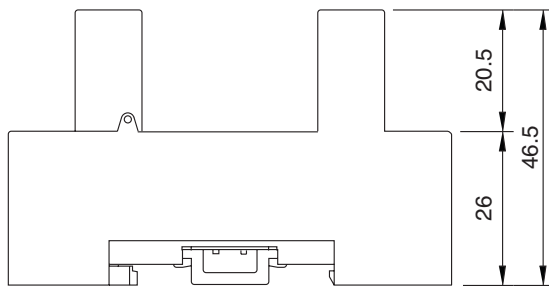

Specifications

Nominal Load: 6 A/250 V

Insulation:

Dielectric strength, 1 minute	
Between contacts and coil	2.5 KV
Between all terminals and rail DIN	2.5 KV
Between adjacent poles	2000 V

Wire In-Lets Capacity:

Solid wire	4 mm ² or 2 x 2.5 mm ²
Multi-core	22-14 AWG
Ferrule tip terminals	4 mm ²
Max. screw torque	1.2 Nm
Screw dimensions	M3, Pozi
Integrated hold-down clip	
Removable marking label	



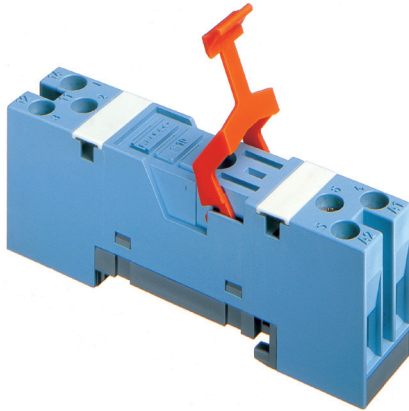

S10

Socket for C10 and CSS relays
DIN rail or panel mountable

10 A 250 V

Wiring Diagram

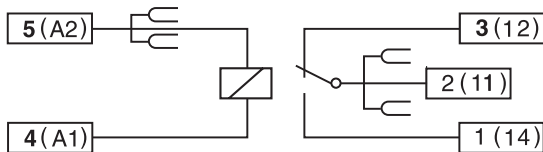

Dimensions - mm

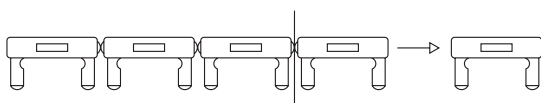
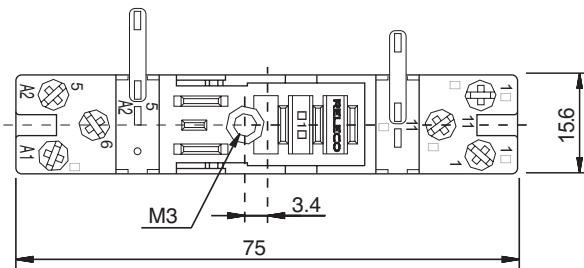
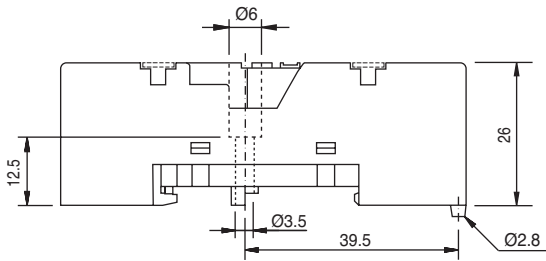

Bridge Bus Bar S10-BB

Interface I/O socket, with terminals in-line for relays C10-A, C10-G, C10-T, CSS

Specifications

Poles	1
Nominal load	10 A/250 V
Dielectric strength	
Coil - contacts	5 kV
Terminals - Rail	5 kV
Max. screw torque	1.2 Nm
Multi-core capacity	22-14 AWG
Solid wire capacity	4 mm ² or 2 x 2.5 mm ²
Weight average	23 g

Other Aspects

- Hard brass tin-plated terminals
- Brass zinc-plated solid screws
- Integrated clip
- Removable marking label

Accessories

- Bridge bar for coil and movable contact (S10-BB)
- Integrated clip
- DIN rail or panel mounting
- Maximum current through bridge 10 A
- Maximum current input common cable 20 A



S10-P



Printed circuit socket for 1 pole IRC Relays



Specifications

Nominal load	10 A/250 V
Dielectric strength, 1 min.	
Coil terminals to contacts	5KV
Hard brass tin-plated terminals	0.5 x 1 mm
Integrated hold-down clip	

S12-P



Printed circuit socket for 2-pole IRC Relays



Specifications

Nominal load	5 A/250 V
Dielectric strength, 1 min.	
Coil terminals to contacts	5KV
Hard brass tin-plated terminals	0.5 x 1 mm
Integrated hold-down clip	

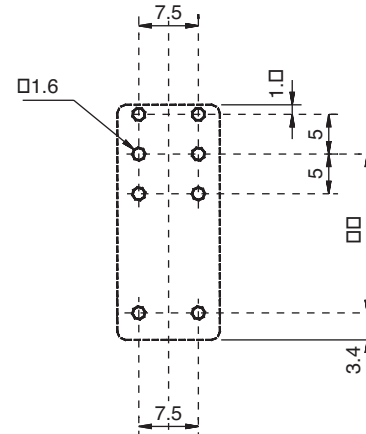
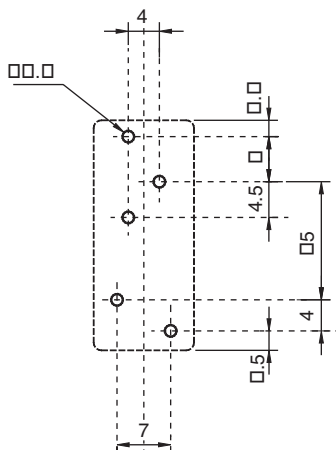
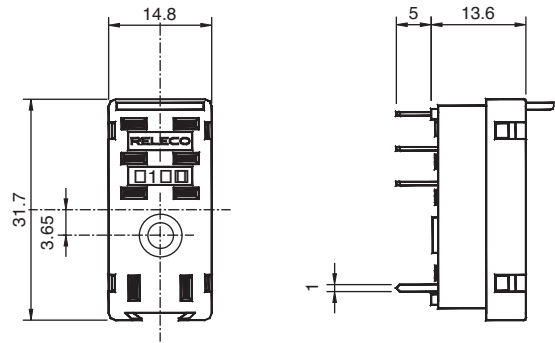
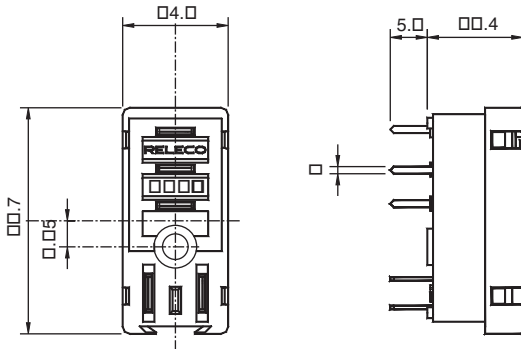

IEC 61810 EN 60947

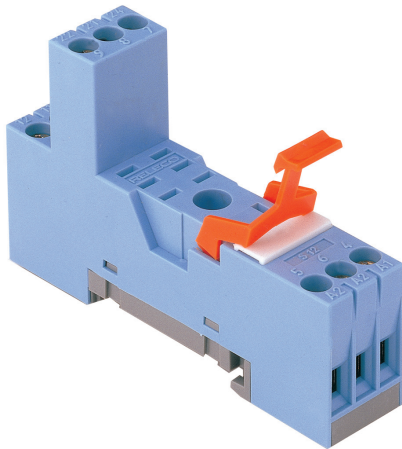

S12



I/O socket for IRC relays two pole, change-over contacts

5 A

I/O socket with terminals in-line, for relays C12, C12G

Din or panel mountable
Removable label
According to EN 60947 and IEC 61810

Wiring Diagram

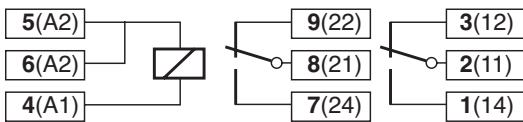

Dimensions - mm

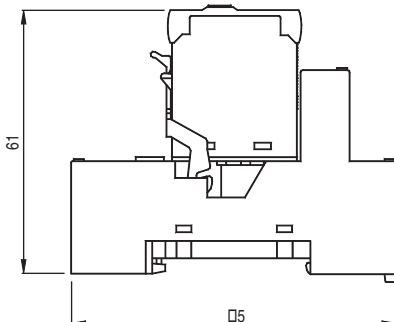
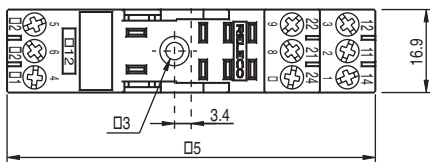
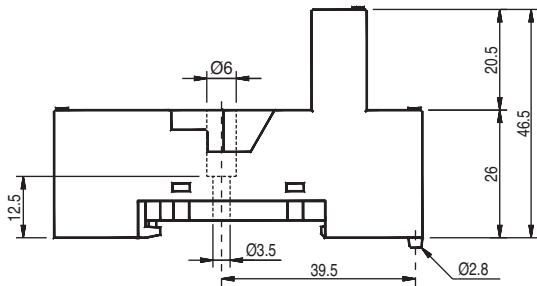

Specifications

Poles	Two change-over contacts
Nominal load	5 A/250V
Insulation:	
Between coil and contacts	5 KV
Between every terminal and DIN rail	5 KV
Between adjacent contacts	3 KV
Max. screw torque	1.2 Nm
Wire in-lets multi-core capacity	22-14 AWG
Solid wire or ferrule tips capacity	4 mm ²
Solid terminals of zinc-plated brass	
Integrated hold-down clip	
Removable marking label	

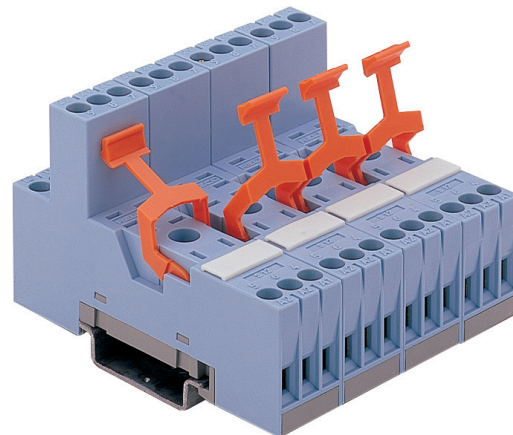

TIMERS

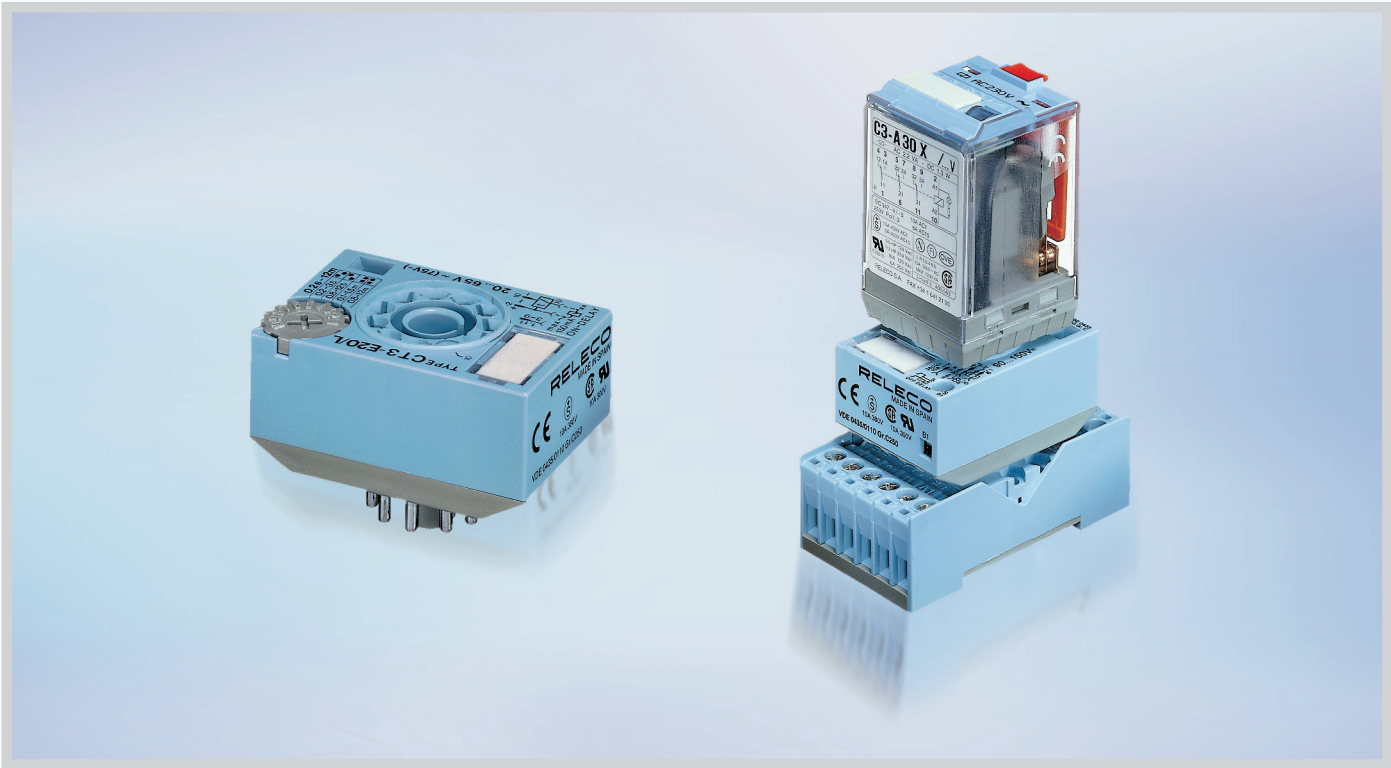

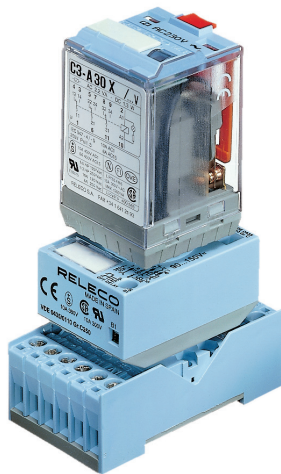
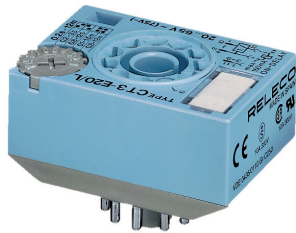

The modules **CT 2** and **CT 3** are electronic timers that are designed to be inserted between a standard plug-in relay and its socket, enabling the relay to be operated as a timer relay.

The **CT** modules are able to accept any standard 8 or 11-Pin RELECO series C2 or C3 as well as those from any other supplier.

The relay coil voltage must be in the range shown for each model.

CT 2A

Off delay

The timing starts when S is switched off. The relay drops out at time (t).

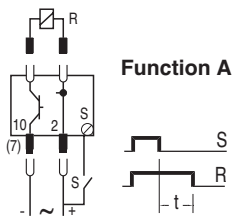

CT 2-A30/S*9.5-18 V
CT 2-A30/L20-65 V
CT 2-A30/M90-150 V
CT 2-A30/U180-265 V

CT 3-A30/S*9.5-18 V
CT 3-A30/L20-65 V
CT 3-A30/M90-150 V
CT 3-A30/U180-265 V

CT 3A

CT 2B

Blinker

The relay blinks ON/OFF at time (t) when switch S is closed. First pulse, ON.

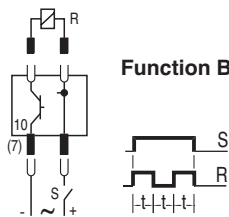

CT 2-B30/S*9.5-18 V
CT 2-B30/L20-65 V
CT 2-B30/H90-265 V

CT 3-B30/S*9.5-18 V
CT 3-B30/L20-65 V
CT 3-B30/H90-265 V

CT 3B

CT 2E

On delay

The timing starts when the switch S is closed. The relay pulls in at the time (t).

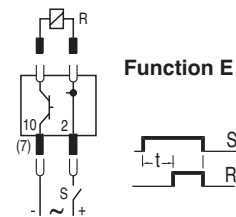

CT 2-E30/S*9.5-18 V
CT 2-E30/L20-65 V
CT 2-E30/H90-265 V

CT 3-E30/S*9.5-18 V
CT 3-E30/L20-65 V
CT 3-E30/H90-265 V

CT 3E

*All types are for AC/DC except *S* voltage range (only DC)

CT2... (8-Pin) and CT3... (11-Pin) types with time range from 0.2 seconds to 30 minutes (range 30)

Specifications

Time accuracy

Repetition	+0.5%/20 ms
Supply voltage	1 ms / volt.
Reset time (types E, W, B)	<200 ms
Reset time (types A, K)	<80 ms
Triggering time: AC, 80 ms;	DC, 50 ms
Ambient temperature	-25°C to +60°C
Transient protection	IEC 255.4
Housing material	Lexan
Protection class (DIN 40050)	IP 40
Weight avg.	35 g

Time Range Setting

Range 30	Dip - Sw
0.2-3 s	
2-30 s	
0.2-3 min	
2-30 min	



Dimensions

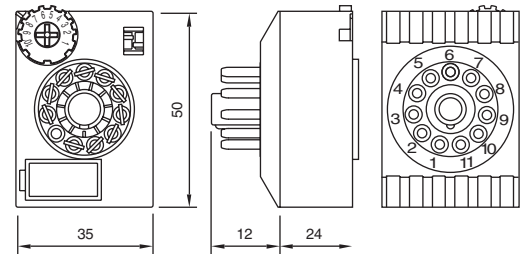

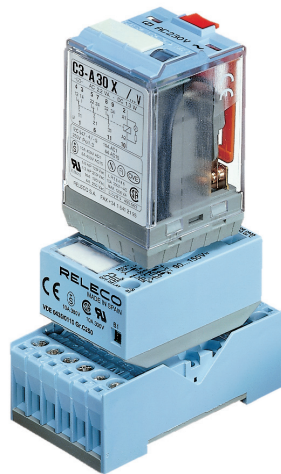
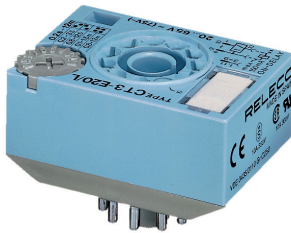

The modules **CT 2** and **CT 3** are electronic timers that are designed to be inserted between a standard plug-in relay and its socket, enabling the relay to be operated as a timer relay.

The **CT** modules are able to accept any standard 8 or 11-Pin RELECO series C2 or C3 as well as those from any other supplier.

The relay coil voltage must be in the range shown for each model.

CT 2K CT 3K

One shot, aux. pulse

The relay turns ON with a pulse on the switch S and turns OFF at the time (t).

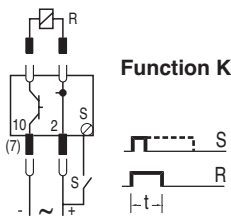

- CT 2-K30/S*9.5-18 V
- CT 2-K30/L20-65 V
- CT 2-K30/M 90-150 V
- CT 2-K30/U 180-265 V

- CT 3-K30/S*9.5-18 V
- CT 3-K30/L20-65 V
- CT 3-K30/M 90-150 V
- CT 3-K30/U 180-265 V

CT 2W CT 3W

One shot

The relay turns ON as switch S is closed and turns OFF at the time (t).

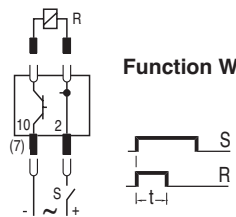

- CT 2-W30/S*9.5-18 V
- CT 2-W30/L20-65 V
- CT 2-W30/H 90-265 V

- CT 3-W30/S*9.5-18 V
- CT 3-W30/L20-65 V
- CT 3-W30/H 90-265 V

*All types are for AC/DC except "S" voltage range (only DC)

CT2... (8-Pin) and CT3... (11-Pin) types with time range from 0.2 seconds to 30 minutes (range 30)

Specifications

Time accuracy	
Repetition	+0.5%/20 ms
Supply voltage	1 ms / volt.
Reset time (types E, W, B)	<200 ms
Reset time (types A, K)	<80 ms
Triggering time: AC, 80 ms;	DC, 50 ms
Ambient temperature	-25°C to +60°C
Transient protection	IEC 255.4
Housing material	Lexan
Protection class (DIN 40050)	IP 40
Weight avg.	35 g

Time Range Setting

Range 30	Dip - Sw
0.2-3 s	
2-30 s	
0.2-3 min	
2-30 min	



Dimensions

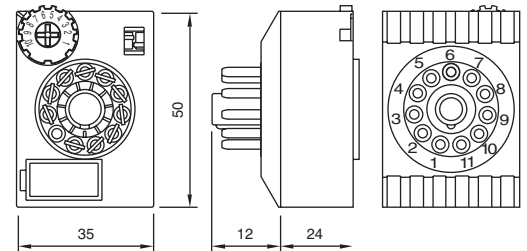

Notes:



USA

TURCK Inc.
3000 Campus Drive
Minneapolis, MN 55441
Phone: (763) 553-7300
Fax: (763) 553-0708
Application Support:
1-800-544-7769
E-mail: turckusa@turck.com
www.turck.us



MEXICO

TURCK MEXICO S. DE R.L. DE C.V.
Carr. Saltillo-Zacatecas km 4.5 s/n
Parque Industrial "La Angostura"
Saltillo, COAH. C.P. 25070
Mexico
Phone: +52 (844) 411-6650/46
Fax: +52 (844) 482-6926
Local Toll Free: 01-800-01-88725
E-mail: ventasmexico@turck.com



CANADA

CHARTWELL ELECTRONICS, INC.
140 Duffield Drive
Markham, Ontario
Canada, L6G 1B5
Phone: (905) 513-7100
Fax: (905) 513-7101
Toll Free: 1-877-513-7769



AUSTRALIA

TURCK Australia Pty. Ltd.
Unit 5, 6-7 Gilda Court
Mulgrave, Victoria 3170
Australia
Phone: (+61) 3 9560 9006
Fax: (+61) 3 9560 1620
Local Toll Free: 1300 132566
E-mail: turckaustralia@turck.com



GERMANY

WORLD HEADQUARTERS

Hans TURCK GmbH & Co. KG
Witzlebenstrasse 7
D-45472 Muelheim an der Ruhr
Federal Republic of Germany
Phone: (+49) 208-49 52-0
Fax: (+49) 208-49 52 264

www.turck.com

....**Sense It!**....**Connect It!**....**Bus It!**....**Solve It!**™