

ESH, Aluminum Electrolytic, 105C, 2200 uF, 20%, 35 V, -40/+105C, Lead Spacing = 7.5mm

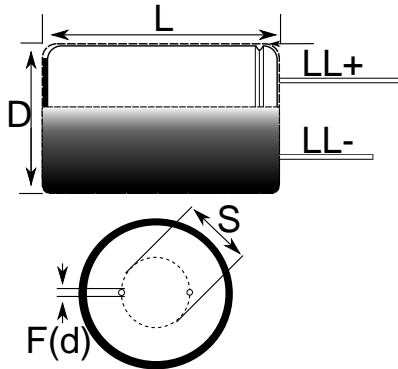

Note: '()' correspond to the letters used in the product bulletin

Dimensions	
D	16mm +/-0.5mm
L	25mm +2.0/-0mm
S	7.5mm +/-0.5mm
LL Negative	15mm MIN
LL Positive	20mm MIN
F	0.8mm NOM

Packaging Specifications	
Packaging:	Bulk, Bag
Packaging Quantity:	1000

General Information	
Supplier:	KEMET
Series:	ESH
Dielectric:	Aluminum Electrolytic
Description:	Single Ended Aluminum Electrolytic
RoHS:	Yes
Lead:	Wire Leads

Specifications	
Capacitance:	2200 uF
Capacitance Tolerance:	20%
Voltage DC:	35 VDC, 44 VDC (Surge)
Temperature Range:	-40/+105C
Rated Temperature:	105C
Life:	2000 Hrs
Dissipation Factor:	14% 120Hz 25C
Current:	1370 mAmps (120Hz 105C)
Leakage Current:	770 uA (2min 20C)
Impedance Ratio at -25C:	2
Impedance Ratio at -40C:	3