

OMNIMATE Power - series LX
LX 15.00/07/90 4.5SN BK BX
Weidmüller Interface GmbH & Co. KG

Klingenbergstraße 16

D-32758 Detmold

Germany

Fon: +49 5231 1429-0

Fax: +49 5231 14292083

www.weidmueller.com

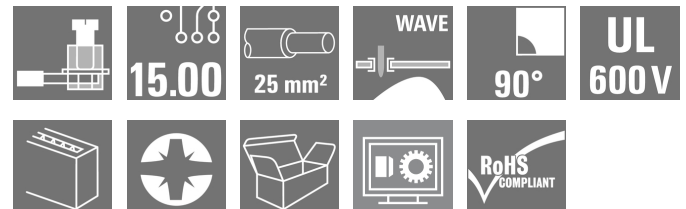

High-performance PCB terminal with proven clamping yoke connection at 15.00 mm pitch, conductor outlet direction in 90° design. Version and test point

- 1.50 - 25 mm² (IEC) / 16 - 4 AWG (UL)
- 1000 V (IEC) / 600 V (UL)
- 101 A (IEC) / 85 A (UL)

General ordering data

Type	LX 15.00/07/90 4.5SN BK BX
Order No.	1226510000
Version	PCB terminal, 15.00 mm, No. of poles: 7, 90°, Solder pin length (l): 4.5 mm, tinned, Black, Clamping yoke connection, Clamping range, rated connection, max.: 25 mm ² , Box
GTIN (EAN)	4050118011210
Qty.	10 pc(s).
Product data	IEC: 1000 V / 101 A / 1.5 - 25 mm ² UL: 600 V / 85 A / AWG 16 - AWG 4
Packaging	Box

**OMNIMATE Power - series LX
LX 15.00/07/90 4.5SN BK BX**

Weidmüller Interface GmbH & Co. KG
 Klingenbergstraße 16
 D-32758 Detmold
 Germany
 Fon: +49 5231 1429-0
 Fax: +49 5231 14292083
 www.weidmueller.com

Technical data**Dimensions and weights**

Net weight	120.5 g
------------	---------

System parameters

Product family	OMNIMATE Power - series LX	Wire connection method	Clamping yoke connection
Mounting onto the PCB	THT solder connection	Conductor outlet direction	90°
Pitch in mm (P)	15 mm	Pitch in inches (P)	0.591 inch
No. of poles	7	Fitted by customer	No
Max. adjacent poles per row	10	Solder pin length (l)	4.5 mm
Solder pin dimensions	1.2 x 1.2 mm	Solder eyelet hole diameter (D)	1.6 mm
Solder eyelet hole diameter tolerance (D)	+ 0,1 mm	Number of solder pins per pole	2
Screwdriver blade	1.0 x 5.5	Screwdriver blade standard	DIN 5264
Tightening torque, min.	2.4 Nm	Tightening torque, max.	4 Nm
Clamping screw	M 5	Stripping length	16 mm
L1 in mm	90 mm	L1 in inches	3.543 inch
Touch-safe protection acc. to DIN VDE 0470	IP 10	Touch-safe protection acc. to DIN VDE 57 106	Safe from finger touch
Volume resistance	0.50 mΩ		

Material data

Insulating material	Wemid (PA)	Colour	Black
Colour chart (similar)	RAL 9011	Insulating material group	I
CTI	≥ 600	Insulation resistance	≥ 10 ⁸ Ω
UL 94 flammability rating	V-0	Contact material	E-Cu
Contact surface	tinned	Layer structure of solder connection	1.5-3 μm Ni / 4-6 μm Sn matt
Storage temperature, min.	-25 °C	Storage temperature, max.	55 °C
Max. relative humidity during storage	80 %	Operating temperature, min.	-50 °C
Operating temperature, max.	120 °C	Temperature range, installation, min.	-25 °C
Temperature range, installation, max.	120 °C		

Conductors suitable for connection

Clamping range, rated connection, min.	1.31 mm ²	Clamping range, rated connection, max.	25 mm ²
Wire connection cross section AWG, min.	AWG 16	Wire connection cross section AWG, max.	AWG 4
Solid, min. H05(07) V-U	1.5 mm ²	Solid, max. H05(07) V-U	16 mm ²
Stranded, min. H07V-R	6 mm ²	Stranded, max. H07V-R	25 mm ²
Flexible, min. H05(07) V-K	1.5 mm ²	Flexible, max. H05(07) V-K	25 mm ²
w. plastic collar ferrule, DIN 46228 pt 4, min.	1.5 mm ²	w. plastic collar ferrule, DIN 46228 pt 4, max.	16 mm ²
w. wire end ferrule, DIN 46228 pt 1, min.	1.5 mm ²	w. wire end ferrule, DIN 46228 pt 1, max.	16 mm ²
Plug gauge acc. to EN 60999 a x b; Ø	6.9 mm x 6.9 mm		

OMNIMATE Power - series LX LX 15.00/07/90 4.5SN BK BX

Weidmüller Interface GmbH & Co. KG
 Klingenbergstraße 16
 D-32758 Detmold
 Germany
 Fon: +49 5231 1429-0
 Fax: +49 5231 14292083
 www.weidmueller.com

Technical data

Rated data acc. to IEC

tested acc. to standard	IEC 60664-1, IEC 61984	Rated current, min. no. of poles (Ta = 20°C)	101 A
Rated current, max. no. of poles (Ta = 20°C)	101 A	Rated current, min. no. of poles (Ta = 40°C)	101 A
Rated current, max. no. of poles (Ta = 40°C)	101 A	Rated voltage for surge voltage class / pollution degree II/2	1,000 V
Rated voltage for surge voltage class / pollution degree III/2	1,000 V	Rated voltage for surge voltage class / pollution degree III/3	1,000 V
Rated impulse voltage for surge voltage class/ pollution degree II/2	6 kV	Rated impulse voltage for surge voltage class/ pollution degree III/2	8 kV
Rated impulse voltage for surge voltage class/ contamination degree III/3	8 kV	Short-time withstand current resistance	3 x 1s mit 1000 A

Rated data acc. to CSA

Rated voltage (Use group B)	600 V	Rated voltage (Use group C)	600 V
Rated voltage (use group D)	600 V	Rated current (use group B)	85 A
Rated current (use group C)	85 A	Rated current (use group D)	5 A
Wire cross-section, AWG, min.	AWG 16	Wire cross-section, AWG, max.	AWG 4

Rated data acc. to UL 1059

Institute (UR)		Certificate No. (UR)	E60693
Rated voltage (use group B)	600 V	Rated voltage (use group C)	600 V
Rated voltage (use group D)	600 V	Rated current (use group B)	85 A
Rated current (use group C)	85 A	Rated current (use group D)	5 A
Wire cross-section, AWG, min.	AWG 16	Wire cross-section, AWG, max.	AWG 4
Reference to approval values	Specifications are maximum values, details - see approval certificate.		

Classifications

ETIM 3.0	EC001284	ETIM 4.0	EC002643
ETIM 5.0	EC002643	ETIM 6.0	EC002643
eClass 6.2	27-26-11-01	eClass 7.1	27-44-04-01
eClass 8.1	27-44-04-01	eClass 9.0	27-44-04-01
eClass 9.1	27-44-04-01		

Data sheet

**OMNIMATE Power - series LX
LX 15.00/07/90 4.5SN BK BX**

Weidmüller Interface GmbH & Co. KG
Klingenbergstraße 16
D-32758 Detmold
Germany
Fon: +49 5231 1429-0
Fax: +49 5231 14292083
www.weidmueller.com

Technical data

Notes

Notes	<ul style="list-style-type: none"> • Additional colours on request • Rated current related to rated cross-section & min. No. of poles. • Wire end ferrule without plastic collar to DIN 46228/1 • Wire end ferrule with plastic collar to DIN 46228/4 • P on drawing = pitch • Rated data refer only to the component itself. Clearance and creepage distances to other components are to be designed in accordance with the relevant application standards. • The test point can only be used as potential-pickup point.
IPC conformity	The products are developed, manufactured and delivered according to the internationally recognised IPC-A-610 standard, category "permissible". More extensive demands on the products can be evaluated on request.

Approvals

Approvals	
ROHS	Conform

Downloads

Approval/Certificate/Document of Conformity	Declaration of the Manufacturer
Brochure/Catalogue	FL DRIVES EN MB DEVICE MANUF. EN FL DRIVES DE CAT 2 PORTFOLIOGUIDE EN FL APPL. INVERTER EN FL_BASE_STATION_EN FL ELEVATOR EN FL POWER SUPPLY EN FL 72H SAMPLE SER EN PO OMNIMATE EN
Engineering Data	EPLAN, WSCAD
Motion controllers white paper	Download Whitepaper
White Paper UL 600 V	Download Whitepaper

**OMNIMATE Power - series LX
LX 15.00/07/90 4.5SN BK BX**

Weidmüller Interface GmbH & Co. KG
Klingenbergstraße 16
D-32758 Detmold
Germany
Fon: +49 5231 1429-0
Fax: +49 5231 14292083
www.weidmueller.com

Drawings

Dimensional drawing

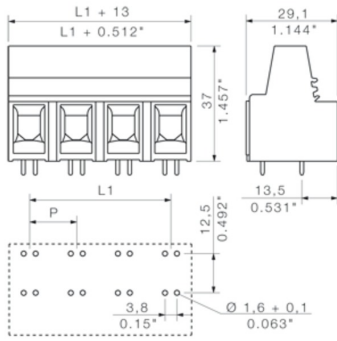

Graph

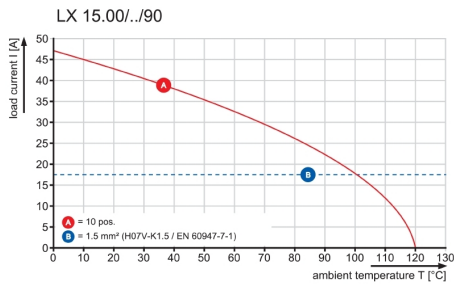

Graph

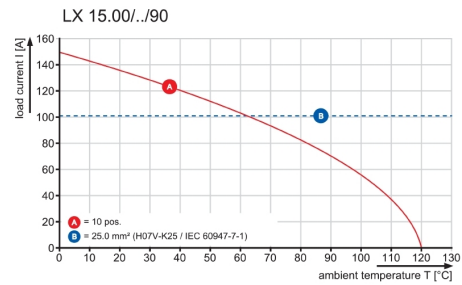

Recommended wave soldering profiles

Weidmüller Interface GmbH & Co. KG
 Klingenbergstraße 16
 D-32758 Detmold
 Germany
 Fon: +49 5231 14-0
 Fax: +49 5231 14-292083
 www.weidmueller.com

Single Wave:

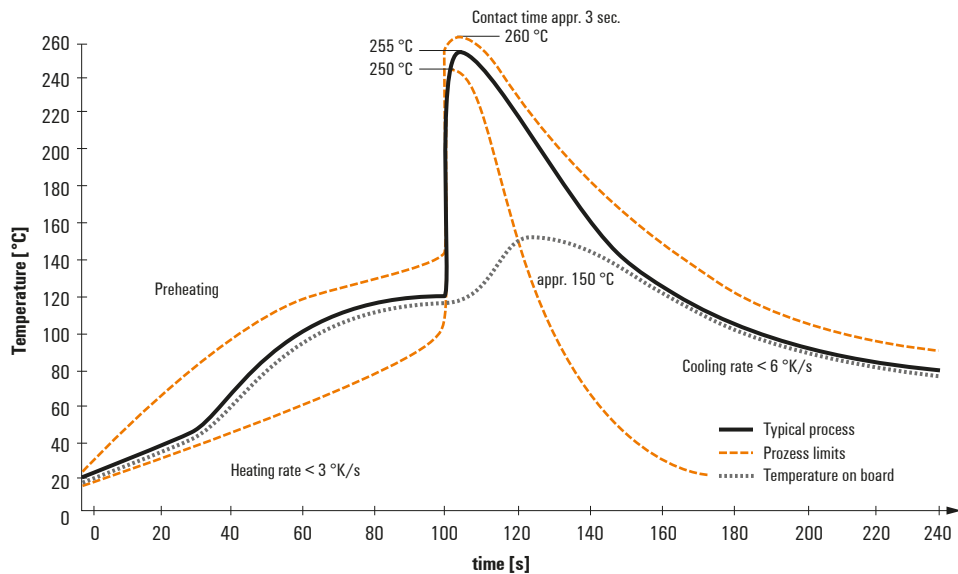

Double Wave:

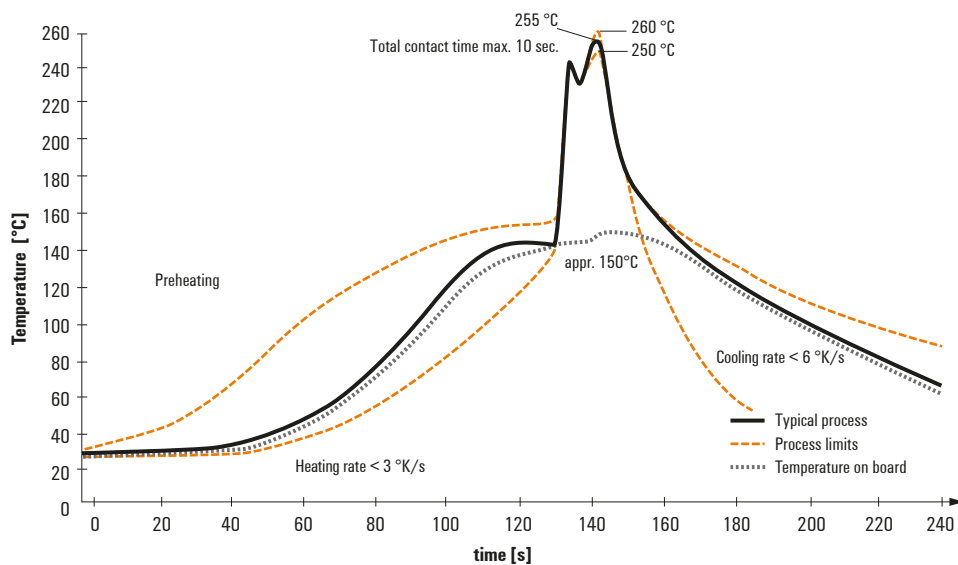

Wave soldering profiles

Wired connection elements should be processed in accordance with the DIN EN 61760-1 standard. We have included two recommendations for practical wave soldering profiles, with which Weidmüller PCB terminals and connectors are qualified.

When choosing a suitable profile for your application, the following factors also need to be considered:

- PCB thickness
- Proportion of Cu in the layers
- Single/double-sided assembly
- Product range
- Heating and cooling rates

The single and double wave profiles each indicate the recommended operating range, including the maximum soldering temperature of 260°C. In practice, the maximum soldering temperature is quite often well below the above maximum profile.