

# SYLVANIA

## 26" High Definition LCD TV built-in DVD Player

OWNER'S MANUAL

# 6626LDG A 6626LDG

**5** inch  
Disc ONLY



**INSTRUCCIONES EN ESPAÑOL INCLUIDAS**

**TO RECEIVE DIGITAL/ANALOG SIGNAL,  
YOU MUST CONNECT ANTENNA.**

IF YOU NEED ADDITIONAL ASSISTANCE WITH SET-UP OR OPERATING AFTER READING OWNER'S MANUAL, PLEASE CALL TOLL FREE **1-800-968-3429**, OR VISIT OUR WEB SITE AT **<http://www.SylvaniaConsumerElectronics.com>**

INTRODUCTION

PREPARATION

SETTING TV

OPERATING TV

OPERATING DVD

SETTING DVD

TROUBLESHOOTING

INFORMATION

ESPAÑOL

**WARNING: TO REDUCE THE RISK OF FIRE OR ELECTRIC SHOCK, DO NOT EXPOSE THIS APPLIANCE TO RAIN OR MOISTURE.**

**CAUTION**

**RISK OF ELECTRIC SHOCK**

**DO NOT OPEN**

**CAUTION:** TO REDUCE THE RISK OF ELECTRIC SHOCK, DO NOT REMOVE COVER (OR BACK). NO USER SERVICEABLE PARTS INSIDE. REFER SERVICING TO QUALIFIED SERVICE PERSONNEL.

THIS SYMBOL INDICATES THAT DANGEROUS VOLTAGE CONSTITUTING A RISK OF ELECTRIC SHOCK IS PRESENT WITHIN THIS UNIT.

THIS SYMBOL INDICATES THAT THERE ARE IMPORTANT OPERATING AND MAINTENANCE INSTRUCTIONS IN THE LITERATURE ACCOMPANYING THE APPLIANCE.

The important note is located on the rear of the cabinet.

# IMPORTANT SAFEGUARDS

1. **READ INSTRUCTIONS** - All the safety and operating instructions should be read before the appliance is operated.
  2. **RETAIN INSTRUCTIONS** - The safety and operating instructions should be retained for future reference.
  3. **HEED WARNINGS** - All warnings on the appliance and in the operating instructions should be adhered to.
  4. **FOLLOW INSTRUCTIONS** - All operating and use instructions should be followed.
  5. **CLEANING** - Unplug TV from the wall outlet before cleaning. Do not use liquid cleaners or aerosol cleaners. Use a damp cloth for cleaning.  
EXCEPTION: A product that is meant for uninterrupted service and, that for some specific reason, such as the possibility of the loss of an authorization code for a CATV converter, is not intended to be unplugged by the user for cleaning or any other purpose, may exclude the reference to unplugging the appliance in the cleaning description otherwise required in item 5.
  6. **ATTACHMENTS** - Do not use attachments not recommended by the TV manufacturer as they may cause hazards.
  7. **WATER AND MOISTURE** - Do not use this TV near water, for example, near a bath tub, wash bowl, kitchen sink, or laundry tub, in a wet basement, or near a swimming pool, and the like.
  8. **ACCESSORIES** - Do not place this TV on an unstable cart, stand, tripod, bracket, or table. The TV may fall, causing serious injury to someone, and serious damage to the appliance. Use only with a cart, stand, tripod, bracket, or table recommended by the manufacturer, or sold with the TV.  
Any mounting of the appliance should follow the manufacturer's instructions and should use a mounting accessory recommended by the manufacturer. An appliance and cart combination should be moved with care. Quick stops, excessive force, and uneven surfaces may cause the appliance and cart combination to overturn.
- PORTABLE CART WARNING

S3126A
- Any mounting of the appliance should follow the manufacturer's instructions and should use a mounting accessory recommended by the manufacturer. An appliance and cart combination should be moved with care. Quick stops, excessive force, and uneven surfaces may cause the appliance and cart combination to overturn.
- SYMBOLE D'AVERTISSEMENT POUR LES COMPOSANTES APPAREIL ET MEUBLES A ROULETTES

S3126A
9. **VENTILATION** - Slots and openings in the cabinet and the back or bottom are provided for ventilation and to ensure reliable operation of the TV and to protect it from overheating, these openings must not be blocked or covered. The openings should never be blocked by placing the TV on a bed, sofa, rug, or other similar surface. This TV should never be placed near or over a radiator or heat register. This TV should not be placed in a built-in installation such as a bookcase or rack unless proper ventilation is provided or the manufacturer's instructions have been adhered to.

10. **POWER SOURCES** - This TV should be operated only from the type of power source indicated on the marking label. If you are not sure of the type of power supply to your home, consult your appliance dealer or local power company. For TVs intended to operate from battery power, or other sources, refer to the operating instructions.
11. **GROUNDING OR POLARIZATION** - This TV is equipped with a polarized alternating-current line plug (a plug having one blade wider than the other). This plug will fit into the power outlet only one way. This is a safety feature. If you are unable to insert the plug fully into the outlet, try reversing the plug. If the plug should still fail to fit, contact your electrician to replace your obsolete outlet. Do not defeat the safety purpose of the polarized plug.
12. **POWER-CORD PROTECTION** - Power-supply cords should be routed so that they are not likely to be walked on or pinched by items placed upon or against them, paying particular attention to cords at plugs, convenience receptacles, and the point where they exit from the appliance.
13. **OUTDOOR ANTENNA GROUNDING** - If an outside antenna or cable system is connected to the TV, be sure the antenna or cable system is grounded so as to provide some protection against voltage surges and built-up static charges. Article 810 of the National Electrical Code, ANSI/NFPA No. 70, provides information with respect to proper grounding of the mast and supporting structure, grounding of the lead-in wire to an antenna discharge unit, size of grounding conductors, location of antenna-discharge unit, connection to grounding electrodes, and requirements for the grounding electrode. (Fig. A)

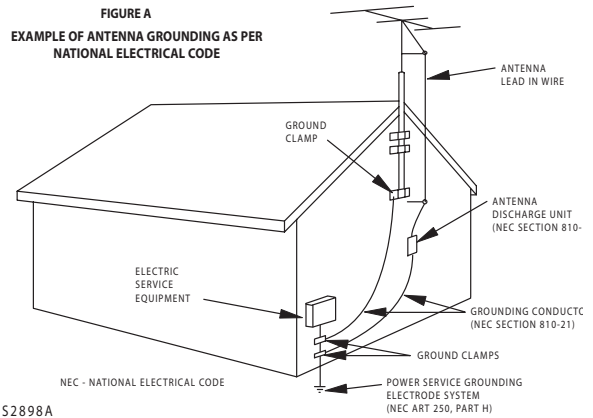

14. **LIGHTNING** - For added protection for this TV receiver during a lightning storm, or when it is left unattended and unused for long periods of time, unplug it from the wall outlet and disconnect the antenna or cable system. This will prevent damage to the TV due to lightning and power-line surges.

15. **POWER LINES** - An outside antenna system should not be located in the vicinity of overhead power lines or other electric light of power circuits, or where it can fall into such power lines or circuits. When installing an outside antenna system, extreme care should be taken to keep from touching such power lines or circuits as contact with them might be fatal.
16. **OVERLOADING** - Do not overload wall outlets and extension cords as this can result in a risk of fire or electric shock.
17. **OBJECT AND LIQUID ENTRY** - Never push objects of any kind into this TV through openings as they may touch dangerous voltage points or short out parts that could result in a fire or electric shock. Never spill liquid of any kind on the TV.
18. **SERVICING** - Do not attempt to service this TV yourself as opening or removing covers may expose you to dangerous voltage or other hazards. Refer all servicing to qualified service personnel.
19. **DAMAGE REQUIRING SERVICE** - Unplug this TV from the wall outlet and refer servicing to qualified service personnel under the following conditions:
  - a. When the power supply cord or plug is damaged or frayed.
  - b. If liquid has been spilled, or objects have fallen into the TV.
  - c. If the TV has been exposed to rain or water.
  - d. If the TV does not operate normally by following the operating instructions. Adjust only those controls that are covered by the operating instructions, as improper adjustment of other controls may result in damage and will often require extensive work by a qualified technician to restore the TV to its normal operation.
  - e. If the TV has been dropped or damaged in any way.
  - f. When the TV exhibits a distinct change in performance, this indicates a need for service.
20. **REPLACEMENT PARTS** - When replacement parts are required, be sure the service technician uses replacement parts specified by the manufacturer that have the same characteristics as the original part. Unauthorized substitutions may result in fire, electric shock, injury to persons or other hazards.
21. **SAFETY CHECK** - Upon completion of any service or repairs to this TV, ask the service technician to perform routine safety checks to determine that the TV is in proper operating condition.
22. **HEAT** - This TV product should be situated away from heat sources such as radiators, heat registers, stoves, or other products (including amplifiers) that produce heat.

## ✓ PRECAUTIONS

**(Hg) LAMP IN LCD CONTAINS MERCURY, DISPOSE ACCORDING TO LOCAL, STATE OR FEDERAL LAW.**

**CAUTION:** TO PREVENT ELECTRIC SHOCK, MATCH WIDE BLADE OF PLUG TO WIDE SLOT, FULLY INSERT.  
**ATTENTION:** POUR ÉVITER LES CHOCs ÉLECTRIQUES, INTRODUIRE LA LAME LA PLUS LARGE DE LA FICHE DANS LA BORNE CORRESPONDANTE DE LA PRISE ET POUSSER JUSQU'AU FOND.

**FCC WARNING** This equipment may generate or use radio frequency energy. Changes or modifications to this equipment may cause harmful interference unless the modifications are expressly approved in the owner's manual. The user could lose the authority to operate this equipment if an unauthorized change or modification is made.

## RADIO-TV INTERFERENCE

This equipment has been tested and found to comply with the limits for a Class B digital device, pursuant to Part 15 of the FCC Rules. These limits are designed to provide reasonable protection against harmful interference in a residential installation. This equipment generates, uses, and can radiate radio frequency energy and, if not installed and used in accordance with the instructions, may cause harmful interference to radio communications.

However, there is no guarantee that interference will not occur in a particular installation. If this equipment does cause harmful interference to radio or television reception, which can be determined by turning the equipment off and on, the user is encouraged to try to correct the interference by one or more of the following measures:

- 1) Reorient or relocate the receiving antenna.
- 2) Increase the separation between the equipment and receiver.
- 3) Connect the equipment into an outlet on a circuit different from that to which the receiver is connected.
- 4) Consult the dealer or an experienced radio/TV technician for help.

**This Class B digital apparatus complies with Canadian ICES-003.**

**Cet appareil numérique de la classe B est conforme à la norme NMB-003 du Canada.**

### **Note to CATV system installer:**

*This reminder is provided to call the CATV system installer's attention to Article 820-40 of the NEC that provides guidelines for proper grounding and, in particular, specifies that the cable ground should be connected to the grounding system of the building as close to the point of cable entry as practical.*

## LASER SAFETY

This unit employs a laser. Only a qualified service person should remove the cover or attempt to service this device, due to possible eye injury.

**CAUTION:** USE OF CONTROLS OR ADJUSTMENTS OR PERFORMANCE OF PROCEDURES OTHER THAN THOSE SPECIFIED HEREIN MAY RESULT IN HAZARDOUS RADIATION EXPOSURE.

**CAUTION:** VISIBLE AND INVISIBLE LASER RADIATION WHEN OPEN AND INTERLOCK DEFEATED. DO NOT STARE INTO BEAM.

**LOCATION:** INSIDE, NEAR THE DECK MECHANISM.

## IMPORTANT COPYRIGHT INFORMATION

Unauthorized copying, broadcasting, public performance and lending of discs are prohibited.

This product incorporates copyright protection technology that is protected by U.S. patents and other intellectual property rights. Use of this copyright protection technology must be authorized by Macrovision, and is intended for home and other limited viewing uses only unless otherwise authorized by Macrovision. Reverse engineering or disassembly is prohibited.

## LOCATION

For safe operation and satisfactory performance of the unit, keep the following in mind when selecting a place for its installation:

- Shield it from direct sunlight and keep it away from sources of intense heat.
- Avoid dusty or humid places.
- Avoid places with insufficient ventilation for proper heat dissipation. Do not block the ventilation holes at the top and bottom of the unit. Do not place the unit on a carpet because this will block the ventilation holes.
- Install unit in a horizontal position.
- Avoid locations subject to strong vibration.
- Do not place the unit near strong magnetic fields.
- Avoid moving unit to locations where temperature differences are extreme.
- Be sure to remove disc and unplug the AC power cord from the outlet before carrying the unit.

## TO AVOID THE HAZARDS OF ELECTRICAL SHOCK AND FIRE

- Do not handle the power cord with wet hands.
- Do not pull on the power cord when disconnecting it from an AC wall outlet. Grasp it by the plug.
- If, by accident, water is spilled on your unit, unplug the power cord immediately and take the unit to our Authorized Service Center for servicing.
- Do not put your fingers or objects into the unit or disc loading slot.
- Do not place anything directly on top of the unit.

## MOISTURE WARNING

- Moisture condensation may occur inside the unit when it is moved from a cold place to a warm place, or after heating a cold room or under conditions of high humidity. If you play a DVD or Audio CD in a moist unit, it may damage the DVD or Audio CD and the unit. When the condensation occurs inside the unit, turn the unit on and leave it at least 2 hours to dry out.

The serial number of this product may be found on the back of the TV. No others have the same serial number as yours. You should record the number and other vital information here and retain this book as a permanent record of your purchase to aid identification in case of theft.

Date of Purchase	Dealer Phone No.	Serial No.
Dealer Purchase from	Model No.	Dealer Address

### Note about recycling:

- *This product's packaging materials are recyclable and can be reused. Please dispose of any materials in accordance with your local recycling regulations.*
- *Batteries should never be thrown away or incinerated but disposed of in accordance with your local regulations concerning chemical wastes.*

## ✓ SUPPLIED ACCESSORIES

- Owner's Manual (1EMN22057A)



- Remote Control Unit (NF013UD)



- Batteries ("AA" x 2)

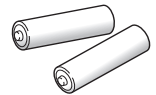

- If you need to replace these accessories, please refer to the PART No. with the illustrations and call our toll free customer support line found on the cover of this manual.
- Depending on your antenna system, you may need different types of combiners (mixers) or separators (splitters). Contact your local electronics store for these items.

## ✓ SYMBOLS USED IN THIS MANUAL

The following is the description for the symbols used in this manual.  
Description refers to:

**TV**

: Analog TV operation.

**DTV**

: Digital TV operation.

**DVD**

: playback of DVD-Video discs.

**CD**

: playback of Audio CDs.

**MP3**

: playback of CD-RW/-R with MP3 files.

**JPEG**

: playback of CD-RW/-R with JPEG files.

- If neither symbol appears under the function heading, operation is applicable to both.

# ✓ CONTENTS

## INTRODUCTION

IMPORTANT SAFEGUARDS .....	2
PRECAUTIONS .....	3
SUPPLIED ACCESSORIES .....	4
SYMBOLS USED IN THIS MANUAL .....	4
FEATURES .....	6
REMOTE CONTROL FUNCTION .....	7
INSTALLING THE BATTERIES .....	7
CONTROL PANEL .....	8
REAR PANEL .....	8

## PREPARATION

CONNECTION .....	9
CONNECTING OTHER DEVICES .....	10

## TV FUNCTIONS

### SETTING TV

INITIAL SETTINGS .....	13
AUTOSCAN .....	14
CHANNEL LIST .....	15
MANUAL REGISTER .....	15
ANTENNA CONFIRMATION .....	16
LANGUAGE SELECTION .....	16

### OPERATING TV

CHANNEL SELECTION .....	17
VOLUME ADJUSTMENT .....	17
SELECTING AUDIO CHANNELS .....	18
ACCESSING EXTERNAL DEVICES .....	19
SCREEN INFORMATION .....	19
CHANGING THE SCREEN DISPLAY MODE .....	20
SLEEP TIMER .....	21
SETUP SCREEN .....	21
PICTURE ADJUSTMENT .....	22
CLOSED CAPTION .....	23
DTV CLOSED CAPTION .....	24
CLOSED CAPTION STYLE .....	24
V-CHIP .....	26
HDMI AUDIO .....	28

## DVD FUNCTIONS

### OPERATING DVD

PLAYABLE MEDIA .....	29
UNPLAYABLE MEDIA .....	29
PLAYBACK .....	30
DVD MENU .....	30
RESUME .....	30
PAUSED AND STEP-BY-STEP PLAYBACK .....	30
FAST FORWARD / FAST REVERSE .....	31
SLOW FORWARD / SLOW REVERSE .....	31
ZOOM .....	31
MP3, JPEG PLAYBACK .....	32
DUAL PLAYBACK .....	32
FOLDER PLAYBACK .....	33
TRANSITION MODE .....	33
ADJUSTMENT OF PICTURE SIZE .....	33
SEARCH FUNCTIONS .....	34
REPEAT PLAYBACK .....	35
REPEAT A-B PLAYBACK .....	36
RANDOM PLAYBACK .....	36
PROGRAMMED PLAYBACK .....	36
ON-SCREEN DISPLAY .....	37
SPECIAL SETTINGS .....	38

### SETTING DVD

DVD LANGUAGE SETTING .....	40
DVD AUDIO SETTING .....	41
PARENTAL SETTING .....	42
OTHERS .....	43
RESET TO THE DEFAULT SETTING .....	44
LANGUAGE CODE LIST .....	44

### TROUBLESHOOTING

TROUBLESHOOTING GUIDE .....	45
-----------------------------	----

### INFORMATION

GLOSSARY .....	47
CABLE CHANNEL DESIGNATIONS .....	47
MAINTENANCE .....	47
GENERAL SPECIFICATIONS .....	48
ELECTRICAL SPECIFICATION .....	48
OTHER SPECIFICATIONS .....	48

## ESPAÑOL

FUNCIONES DEL MANDO A DISTANCIA .....	49
INSTALACIÓN DE LAS PILAS .....	49
PANEL DE CONTROL .....	50
PANEL TRASERO .....	50
CONEXIÓN .....	51
CONEXIÓN DE OTROS DISPOSITIVOS .....	52
PREAJUSTES INICIAL .....	55
PREA. AUTO CA. ....	56
LISTA DE CANALES .....	56
REGISTRO MANUAL .....	57
SELECCIÓN DE IDIOMA .....	57
REPRODUCCIÓN .....	58
MENÚ DVD .....	58
REANUDACIÓN .....	58
PAUSA Y REPRODUCCIÓN PASO A PASO .....	58
AVANCE RÁPIDO / RETROCESO RÁPIDO .....	59
AVANCE LENTO / RETROCESO LENTO .....	59
REPRODUCCIÓN DE MP3, JPEG .....	59

LIMITED WARRANTY .....	Back cover
------------------------	------------

## ✓ FEATURES

### TV

- **DTV/TV/CATV**
  - You can use your remote control to select channels which are broadcast in conventional analog, standard definition, and high definition formats. Also, cable subscribers can access their cable TV channels.
- **Program Information Display (DTV only)**
  - You can display the title, contents and other information of the current DTV program on the screen.
- **Autoscan**
  - Your TV automatically scans and memorizes channels available in your area, eliminating difficult set-up procedures.
- **V-CHIP**
  - This feature allows you to block children's access to inappropriate programs.
- **Closed Caption Decoder**
  - Built-in closed caption decoder displays text of audio transmission for closed caption supported programming.
- **MTS/SAP Tuner**
  - Audio language can be selected from the remote control.
- **Auto Shut Off Function**
  - Unit turns itself off automatically after 15 minutes of no operation or no signal input from the antenna terminal.
- **Choices for On-Screen Menu Language**
  - Select your setup menu language: English, Spanish or French.
- **Stereo Sound Function**
- **Full-Function Remote Control**
- **PLL Frequency Synthesized Tuning**
- **HDMI Input**
  - This TV accepts 480i / 480p / 720p / 1080i video signals and 32kHz / 44.1kHz / 48kHz audio signals.
- **Component VIDEO Input**
  - This TV accepts 480i / 480p / 720p / 1080i video signals.
- **S-VIDEO Input**
- **AV Input**
- **Analog Audio Output**
- **Digital Audio Output (Coaxial)**

### DVD

- **Dolby Digital Sound**
  - Enjoy Dolby Digital multi-channel surround sound when you connect your TV to a Dolby Digital decoder.
- **Still / Fast / Slow / Step Playback**
  - Various playback modes are available including still pictures, fast forward/reverse, slow motion and step frames.
- **Random Playback for Audio CD, MP3 and JPEG**
  - This unit can shuffle the order of tracks to play them back in random order.
- **Program Playback for Audio CD, MP3 and JPEG**
  - You can program the order of tracks to play them back in desired order.
- **DVD Menus in a Desired Language**
  - You can display DVD menus in a desired language, if available on a DVD.
- **Screen Saver**
  - The screen saver program starts when there is no input from the unit for 5 minutes in stop mode.
- **Subtitles in a Desired Language**
  - You can select a desired language for the display subtitles, if that language is available on a disc.
- **Selecting a Camera Angle**
  - You can select the desired camera angle, if a disc contains sequences recorded from different angles.
- **Choices for On-Screen Menu Language**
  - Select your setup menu language: English, Spanish or French.
- **Choices for Audio Language and Sound Mode**
  - Select your desired language or sound mode when different options are available on your disc.
- **Parental Lock**
  - Block the viewing of discs unsuitable for children.
- **Automatic Detection of Discs**
  - This unit automatically detects if the loaded disc is DVD, Audio CD or CD-RW/-R with MP3 or JPEG files.
- **On-Screen Display**
  - Displays current information regarding TV operations (such as program playback). This function is accessible by remote control.
- **Search**
  - Chapter search / Title search / Track search / Time search
- **Repeat**
  - Chapter / Title / Track / Group / All / A-B
- **Zoom**
  - Allows you to enlarge video image.
- **Marker**
  - The part designated by user can be called back.
- **Resume Play**
  - Lets you resume play from where you left off.
- **Virtual Surround**
- **Bit Rate Indication**
- **DRC (Dynamic range control)**
  - You can control the range of sound volume.

## ✓ REMOTE CONTROL FUNCTION

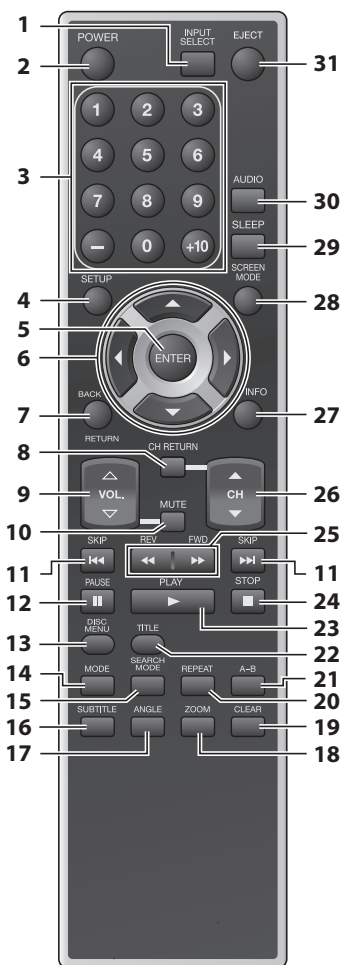

1. **INPUT SELECT button** (p19)  
Press to access connected external devices like a DVD recorder or VCR.
2. **POWER button** (p13)  
Press to turn TV/DVD on and off.
3. **Number buttons** (p17)  
• Press to select a channel.  
• Press to input number of title, chapter or track.
4. **SETUP button** (p21)  
Press to display on-screen menu.
5. **ENTER button** (p13)  
Press to confirm your selection.
6. **◀/▶ / ▲ / ▼ buttons** (p13)  
To move left/ right/ up/ down through the items.
7. **BACK/RETURN button** (p19)  
Press to return to previous menu operation.
8. **CH RETURN button** (p17)  
Press to return to previously viewed channel.
9. **VOL. ▲/▼ buttons** (p17)  
Press to adjust volume.
10. **MUTE button** (p17)  
Press to turn sound off and on.
11. **SKIP◀◀/▶▶ buttons** (p34)  
To skip forward or backward chapters, titles (DVD), tracks (CD, MP3, JPEG) or folders (MP3, JPEG).
12. **PAUSE button** (p30)  
To pause disc playback.
13. **DISC MENU button** (p30 / p32)  
To call up the menu on a disc (DVD) or FILE LIST (MP3, JPEG).
14. **MODE button** (p33 / p36 / p38)  
• To call up the FOLDER LIST on a disc when "Dual Playback" is "ON" (MP3, JPEG).  
• To arrange the playing order or play randomly (CD, MP3, JPEG).  
• To set black level (DVD) and virtual surround (DVD, CD, MP3) on or off.
15. **SEARCH MODE button** (p34)  
• To search chapter, title (DVD), time (DVD, CD) or track (CD, MP3, JPEG).
16. **SUBTITLE button** (p38)  
To select subtitles on a disc (DVD).
17. **ANGLE button** (p38)  
To change the camera angle to see the sequence being played back from different angle (DVD).
18. **ZOOM button** (p31)  
To magnify the part of picture (2X and 4X: DVD, 2X: JPEG).
19. **CLEAR button** (p35 / p36)  
• To clear the numbers entered incorrectly.  
• To cancel the point A for A-B repeat (DVD, CD).  
• To remove track number in program input (CD, MP3, JPEG).
20. **REPEAT button** (p35)  
To play a chapter or title (DVD), track, disc (CD, MP3, JPEG) or group (MP3, JPEG) repeatedly.
21. **A-B button** (p36)  
To repeat between your chosen point A and B (DVD, CD).
22. **TITLE button** (p30)  
To call up the title menu (DVD).
23. **PLAY▶ button** (p30)  
To begin disc playback.
24. **STOP■ button** (p30)  
To stop disc playback.
25. **REV◀◀ / FWD▶▶ buttons** (p31)  
To begin slow forward or slow reverse playback during the pause mode (DVD) and search forward or backward through a disc.
26. **CH▲/▼ buttons** (p17)  
To select channels and external input mode.
27. **INFO button** (p19 / p37)  
• **Analog mode (TV)**  
To display channel No., signal type and TV setting.  
• **Digital mode (DTV)**  
To display channel information, signal type and TV setting.  
• **External input mode**  
To display external input mode, signal type and TV setting.  
• **DVD mode**  
To display the current status (DVD, CD, MP3, JPEG).
28. **SCREEN MODE button** (p20)  
To select aspect ratios available for the screen.
29. **SLEEP button** (p21)  
Press to activate the sleep timer.
30. **AUDIO button** (p18 / p39)  
• **Analog mode (TV)**  
Selects audio mode.  
• **Digital mode (DTV)**  
Selects audio language.  
• **DVD mode**  
Selects audio language (DVD) or sound mode (CD).
31. **EJECT button** (p30)  
To eject the disc.

### NOTE:

- With buttons [VOL. ▲/▼] or [MUTE], you can only adjust the volume of the main unit. You cannot adjust the volume of the external devices with these buttons.
- Unless stated, all operations described are based on remote control use.

## ✓ INSTALLING THE BATTERIES

Install two AA batteries (included) matching the polarity (+/-) indicated inside battery compartment of the remote control.

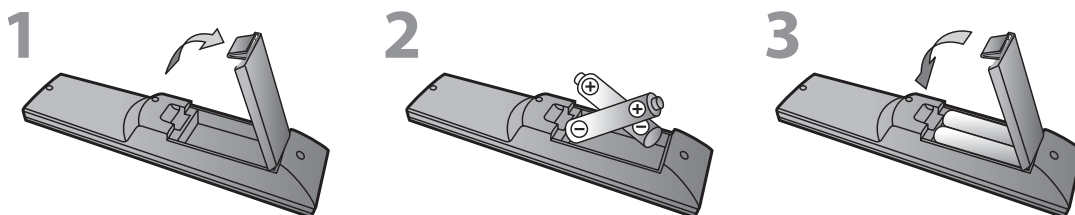

### BATTERY PRECAUTIONS:

- Be sure to follow the correct polarity as indicated in the battery compartment. Reversed batteries may cause damage to the device.
- Do not mix different types of batteries together (e.g. Alkaline and Carbon-Zinc) or old batteries with fresh ones.
- If the device is not to be used for a long period of time, remove the batteries to prevent damage or injury from possible battery leakage.
- Do not try to recharge batteries not intended to be recharged; they can overheat and rupture.

**CONTROL PANEL**

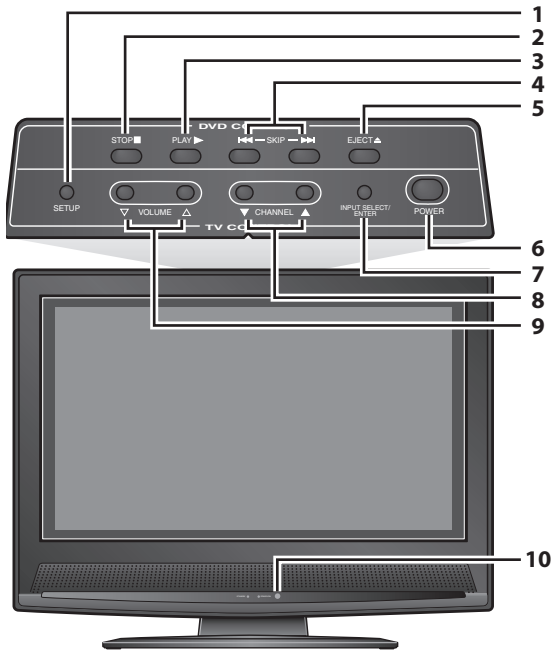

1. **SETUP button** (p21)  
To display on-screen menu.
2. **STOP ■ button** (p30)  
To stop disc playback.
3. **PLAY ► button** (p30)  
To begin disc playback.
4. **SKIP ◀◀ / ▶▶ buttons** (p34)  
To skip chapters, titles (DVD) or tracks (CD, MP3 or JPEG).
5. **EJECT ▲ button** (p30)  
To eject the disc.
6. **POWER button** (p13)  
To turn TV/DVD on or off.
7. **INPUT SELECT/ENTER button** (p19/p13)  
• To access connected external devices like a DVD recorder or VCR.  
• To decide the command of setting when the menu is displayed.
8. **CHANNEL ▲/▼ buttons** (p17)  
To select channels and move up/down through the menu items.
9. **VOLUME ▲/▼ buttons** (p17)  
To adjust volume and move right(▲)/left(▼) through the menu items.
10. **Infrared Sensor Window**  
Receives infrared rays transmitted from the remote control.

**NOTE:**

• With buttons [VOLUME ▲/▼], you can only adjust the volume of the main unit. You cannot adjust the volume of the external devices with these buttons.

**REAR PANEL**

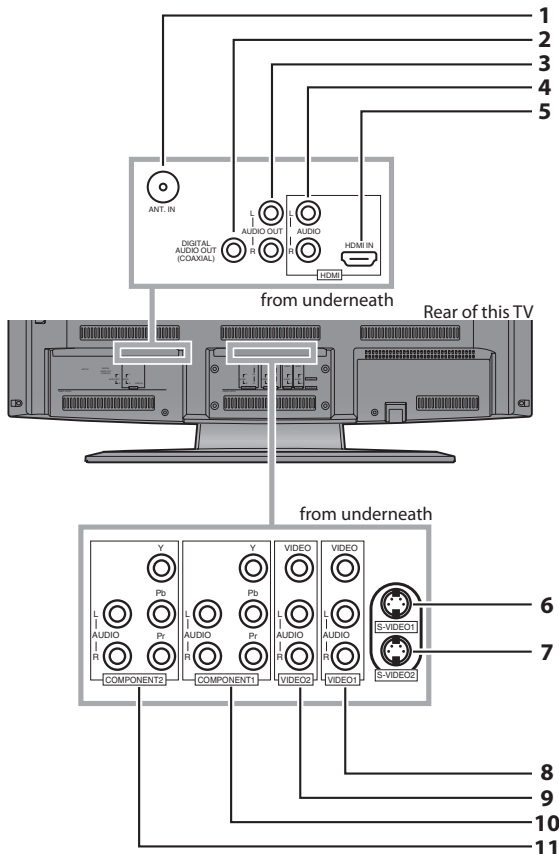

1. **ANT. IN jack** (p9)  
Coaxial cable connection for your antenna or cable box.
2. **DIGITAL AUDIO OUT (COAXIAL) jack** (p12)  
Digital audio coaxial cable connection for decoder or audio receiver. Connect cable to DIGITAL AUDIO IN jack of external device.
3. **AUDIO OUT jacks** (p12)  
Audio cable connection for external audio equipment. Use AUDIO IN jacks of external equipment.
4. **AUDIO input jacks (for DVI connection)** (p10)  
Audio cable connection for external audio/video devices with DVI jack. Use AUDIO OUT jacks of external equipment when using an HDMI-DVI conversion cable.
5. **HDMI IN jack** (p10)  
HDMI cable connection for external video equipment (i.e. DVD recorder).
6. **S-VIDEO1 input jack** (p11)  
S-Video cable and audio ( in VIDEO1 terminal) cable connection for external video equipment.
7. **S-VIDEO2 input jack** (p11)  
S-Video cable and audio ( in VIDEO2 terminal) cable connection for external video equipment.
8. **VIDEO1 and AUDIO input jacks** (p12)  
Video and audio cable connection for external equipment.
9. **VIDEO2 and AUDIO input jacks** (p12)  
Video and audio cable connection for external equipment.
10. **COMPONENT1 and AUDIO input jacks** (p11)  
Component cable connection for external audio/video devices. Use component and audio out jacks of external device.
11. **COMPONENT2 and AUDIO input jacks** (p11)  
Component cable connection for external audio/video devices. Use component and audio out jacks of external device.



## ✓ CONNECTION

This section describes how to connect your TV to an antenna, cable box, etc.

### MAKE SURE YOU HAVE AN ANTENNA.

**As DTV is only available over the air, you need an antenna to receive a digital signal.**

#### NOTE:

- Be sure your antenna or other source is connected properly before plugging in the power cord.

#### [ANTENNA CABLE CONNECTION]

- 1) When connecting your TV to an antenna  
Connect the coaxial cable on your home outlet to the ANT. IN jack of this TV.
- 2) When connecting TV to Cable TV company (without box)  
Connect the coaxial cable on your home outlet to the ANT. IN jack of this TV.

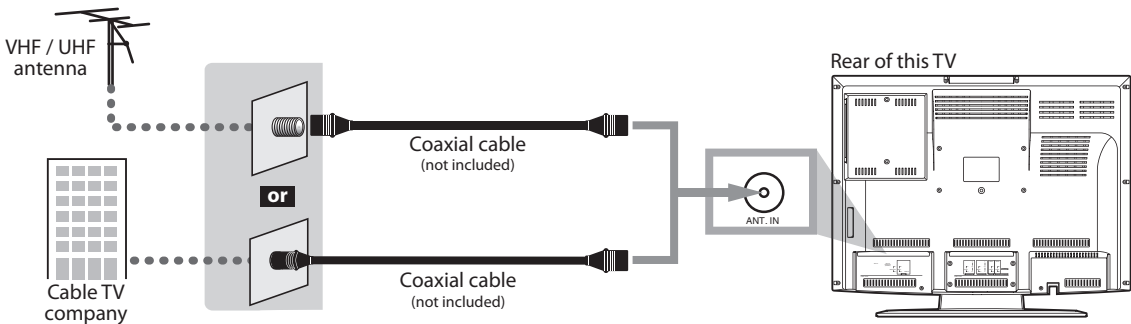

\*Once connections are completed, turn on the TV and begin initial setup.  
Channel scanning is necessary for the TV to memorize all available channels in your area.  
(Refer to "INITIAL SETTINGS" on page 13.)

#### NOTE:

- For your safety and to avoid damage to equipment, please unplug the coaxial cable from the ANT.IN jack before moving the unit.
- If you use an antenna to receive analog TV, it should also work for DTV reception. Outdoor or attic antennas will be more effective than set-top versions.
- To easily switch your reception source between antenna and cable, install an antenna selector (not included).
- If you connect to the cable system directly, contact the CATV installer.

#### [CONNECTION TO CABLE BOX or SATELLITE BOX]

- 1) Connect the coaxial cable on your home outlet to the input jack of the CABLE/SATELLITE box.
- 2) Use another coaxial cable to connect the ANT. IN jack of your TV to the output jack of the CABLE/SATELLITE box.

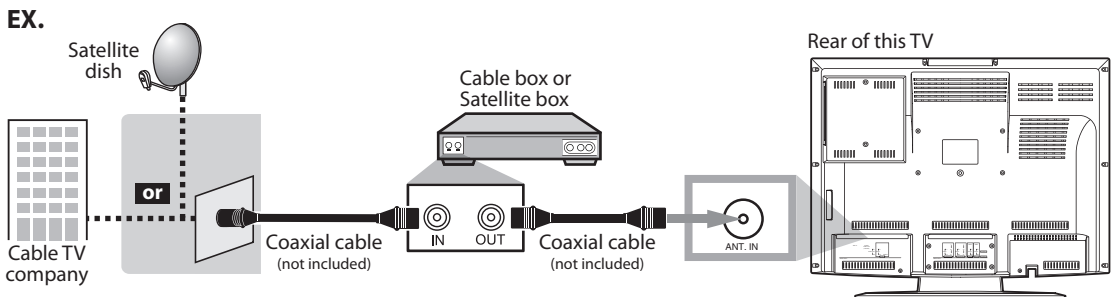

\*Required cables in 2) and connecting methods differ depending on the CABLE/SATELLITE box.  
For more information, please contact your cable/satellite provider.

## ✓ CONNECTING OTHER DEVICES

### [HDMI]

1) High Definition Multimedia Interface (HDMI) uses the latest technology to ensure the signal maintains the highest degree of integrity from source to TV. Both video and audio travel through a single cable.

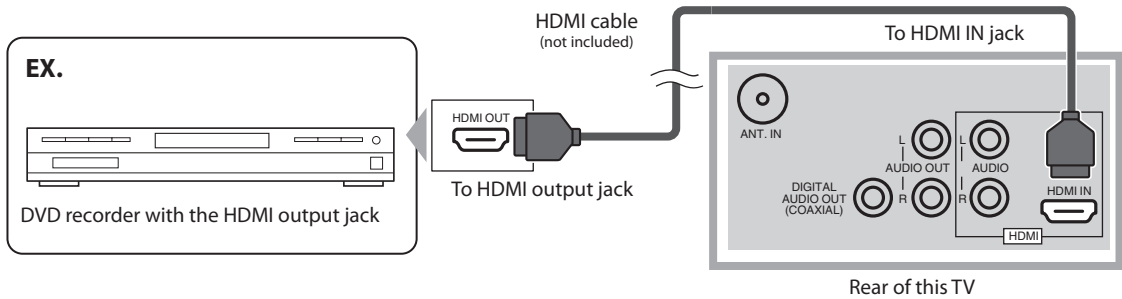

### NOTE:

- This TV accepts 480i / 480p / 720p / 1080i video signals, and 32kHz / 44.1kHz / 48kHz audio signals.
- This TV accepts only 2 channel audio signal (LPCM).
- You need to select "PCM" for the digital audio output of the device you connect or the HDMI audio setting. Audio sometimes makes no sound if you select "Bitstream", etc.
- This TV only accepts signals corresponding EIA861.

2) When your video device has a DVI output jack, connect the HDMI conversion cable (not included) from the DVI output jack.

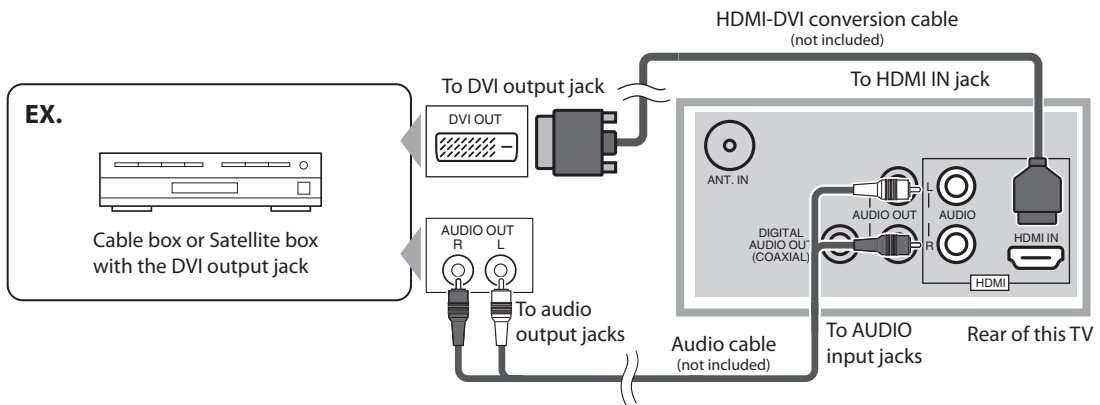

### NOTE:

- This TV accepts 480i / 480p / 720p / 1080i video signals.
- An HDMI conversion cable requires a separate audio cable connection as well.
- Audio signals are converted from digital to analog if you make the connection in paragraph 2) above.
- DVI does not show image if the 480i does not accept EIA/CEA-861/861B.

**HDMI**<sup>™</sup>  
HIGH-DEFINITION MULTIMEDIA INTERFACE

"HDMI, the HDMI logo and High-Definition Multimedia Interface are trademarks or registered trademarks of HDMI Licensing LLC."

### [COMPONENT CABLE CONNECTION]

Offers better picture quality for video devices connected to your TV.

Use a component video cable (not included) to connect your TV to external video devices equipped with component video jacks.

If you connect to your TV's COMPONENT1 input jack, connect audio cables to the AUDIO L/R jacks of COMPONENT1.

If you connect to your TV's COMPONENT2 input jack, connect audio cables to the AUDIO L/R jacks of COMPONENT2.

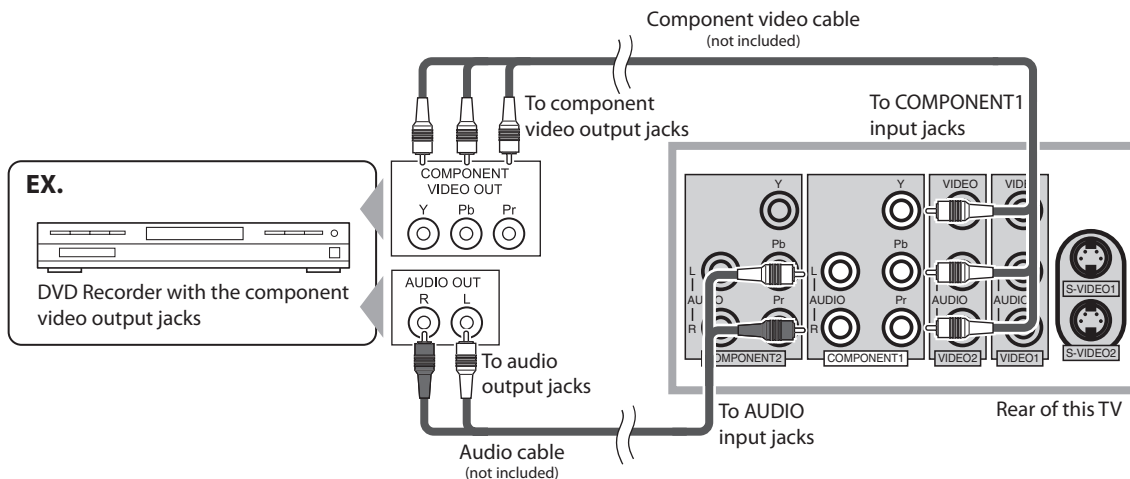

#### NOTE:

• This TV accepts 480i / 480p / 720p / 1080i video signals.

### [S-VIDEO CABLE CONNECTION]

Offers good picture quality for video devices connected to your TV.

Use an S-video cable (not included) to connect your TV to external video devices equipped with S-video connectors.

If you connect to your TV's S-VIDEO1 input jack, connect audio cables to the AUDIO L/R jacks of VIDEO1.

If you connect to your TV's S-VIDEO2 input jack, connect audio cables to the AUDIO L/R jacks of VIDEO2.

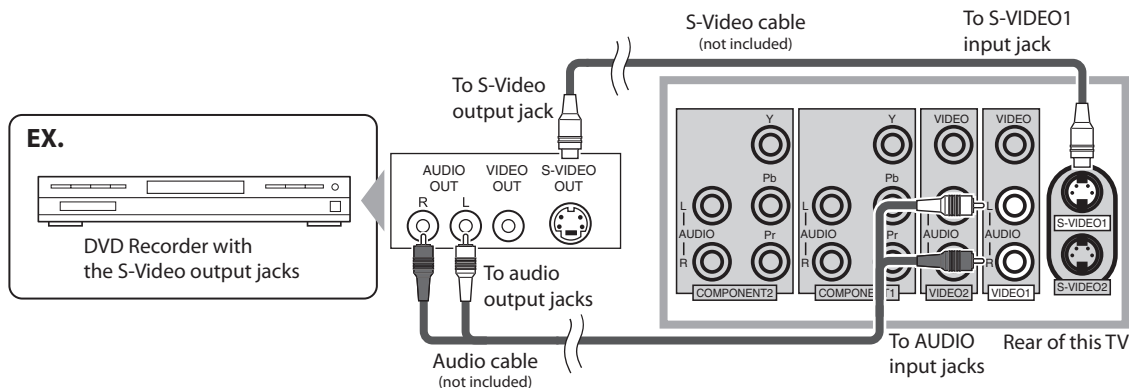

#### NOTE:

• If you connect to the S-Video jack and the VIDEO jack at the same time, the S-Video connection will have priority.

## [VIDEO CONNECTION]

Offers standard picture quality for video devices connected to your TV.

When the audio jack of the video device is monaural, connect the audio cable to the audio L input jack.

If you connect to your TV's VIDEO1 input jack, connect audio cables to the AUDIO L/R jacks of VIDEO1.

If you connect to your TV's VIDEO2 input jack, connect audio cables to the AUDIO L/R jacks of VIDEO2.

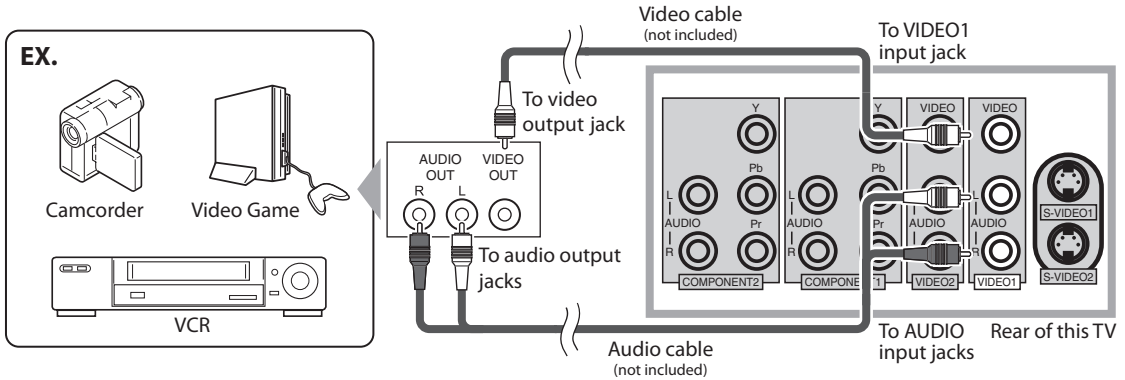

## [DIGITAL AUDIO OUTPUT CONNECTION]

If you connect this TV to an external digital audio device, you can enjoy multi-channel audio like 5.1 ch digital broadcasting sound. Required digital audio coaxial cable not included.

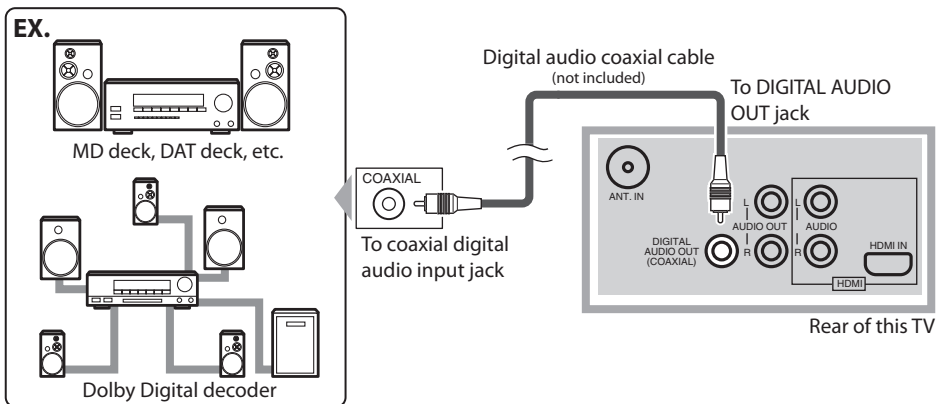

Manufactured under license from Dolby Laboratories. "Dolby" and the double-D symbol are trademarks of Dolby Laboratories.

## [ANALOG AUDIO OUTPUT CONNECTION]

If you connect this TV to an external analog audio device, you can enjoy stereophonic (2 channel) audio sound.

Required audio cable not included.

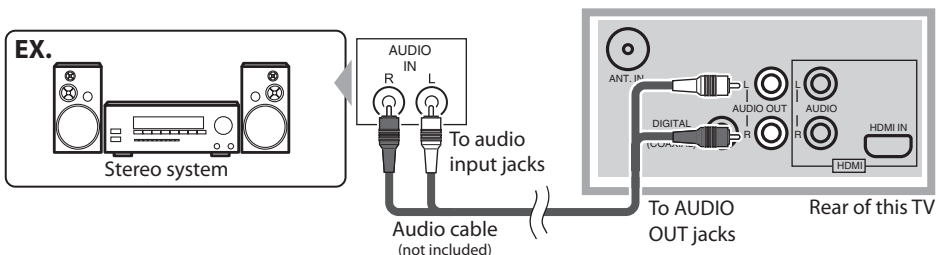

## TV FUNCTIONS

### ✓ INITIAL SETTINGS

This section will guide you through your TV's initial set up which includes selecting a language for your on-screen menu and AUTOSCAN, which automatically scans and memorizes viewable channels.

**1** After making all the necessary connections, turn on your TV.

**2** Press **[POWER]** to display the Initial Setup menu.



- This operation may take a few moments.
- If Initial Setup menu does not appear, press and hold **[ENTER]** for 3 seconds, initial setup will appear then proceed to step 3.
- If initial set up has already been completed, refer to "LANGUAGE SELECTION" on page 16.

**3** When you first turn on your TV, the following screen is displayed. Use **[▲/▼]** to select the on-screen menu language from the choices on the right side of the screen. (English / Español / Français)



- The Antenna Confirmation menu on step 4 will be displayed in the selected language after you press **[ENTER]**.

**4** Use **[▲/▼]** to select source of ANT. IN jack, then press **[ENTER]**.

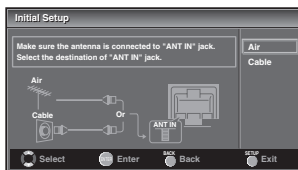
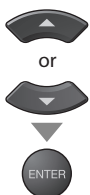

**5** Autoscan will start automatically.

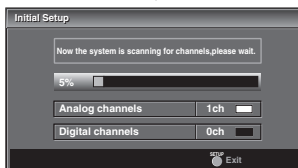

- When scanning has completed, the lowest memorized channel will be displayed.

#### NOTE:

- The initial Autoscan function can be executed for either "Air" or "Cable" only once. When you change the connection (Air/Cable), set the "Autoscan" again. (Refer to page 14.)
- If you connect to the cable system directly, contact the CATV installer.
- When the scanning is not complete, Helpful Hint will be displayed every time you turn on the power. If you have previously registered channels when this screen appears, you can access them with **[the Number buttons]**.

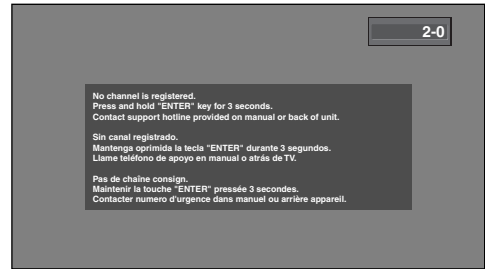

- Toll free customer support line can be found on the cover of this manual.

## ☑ AUTOSCAN

With AUTOSCAN, your TV automatically scans and memorizes your area's viewable channels. Activate AUTOSCAN when you turn on your TV for the first time, change broadcast sources (e.g. from antenna to CATV), or move your TV to a different broadcast area.

1 Press **[SETUP]** to display the setup screen.

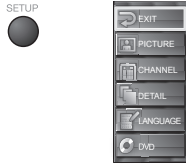

2 Use **[▲/▼]** to select "CHANNEL", then press **[ENTER]**.



3 Use **[▲/▼]** to select "Autoscan", then press **[ENTER]**.

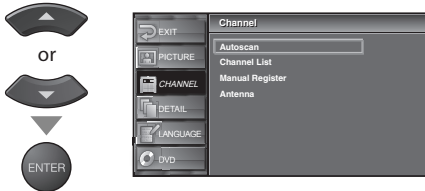

4 Use **[▲/▼]** to select "Air" for TV channels or "Cable" for CATV channels, then press **[ENTER]**.

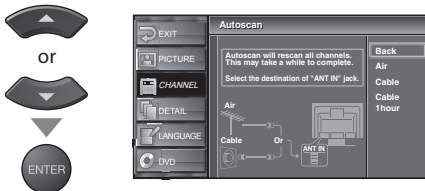

• Scanning and memorizing the channels automatically starts.

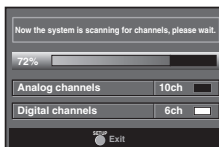

• When the scanning and memorizing are completed, the lowest memorized channel in the broadcasting will be displayed.

### NOTE:

- Make sure the TV is connected to antenna or cable.
- If you connect the cable system directly, contact the CATV installer.
- If you press **[POWER]** or **[SETUP]** during Autoscan, this setting will be canceled.
- If there is no reception or a poor signal is detected, once scanning stops and a Helpful Hint will appear on screen.

## ✓ CHANNEL LIST

This function lets you remove undesired channels from the Channel Registration List.

1 Press **[SETUP]** to display the setup screen.

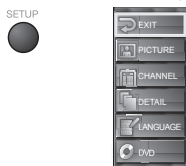

2 Use **[▲/▼]** to select "CHANNEL", then press **[ENTER]**.



3 Use **[▲/▼]** to select "Channel List", then press **[ENTER]**.

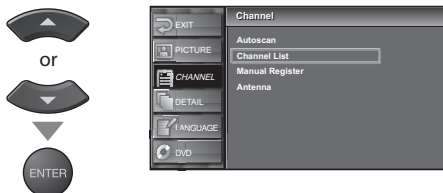

4 Use **[▲/▼]** to select the channel you want to remove.



- Press **[ENTER]** to highlight the channel selected for removal. You will not be able to select the channel again using **[CH ▲/▼]**.
- To reactivate the removed channel, highlight it and press **[ENTER]**.
- When you remove a major channel, you remove its minor channels, too.

### NOTE:

- The channel with "DTV" indicated on the display is ATSC, otherwise the channel is NTSC.
- In the DTV broadcasting, one channel sometimes broadcasts multiple programs depending on the air time. In this case, the main channel is called major channel and the minor channel is called minor channel.

5 To exit the setup, press **[SETUP]**.



## ✓ MANUAL REGISTER

This function lets you manually add channels not memorized due to poor broadcast strength during AUTOSCAN.

1 Press **[SETUP]** to display the setup screen.

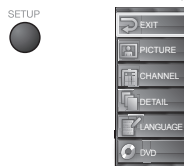

2 Use **[▲/▼]** to select "CHANNEL", then press **[ENTER]**.



3 Use **[▲/▼]** to select "Manual Register", then press **[ENTER]**.



4 Use **[the Number buttons]** to select the channel you want to add, then press **[ENTER]**.

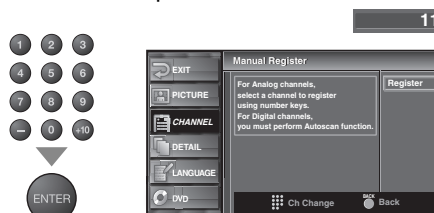

5 To exit the setup, press **[SETUP]**.



### NOTE:

- If set up completes successfully, "Registered to the Channel List" is displayed.
- If Video 1 is being used, set up will not be completed successfully and "Unavailable" will be displayed on the screen.

## ✓ ANTENNA CONFIRMATION

Displays signal strength for each channel.

1 Press **[SETUP]** to display the setup screen.

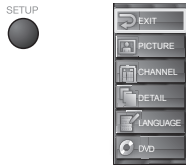

2 Use **[▲/▼]** to select "CHANNEL", then press **[ENTER]**.



3 Use **[▲/▼]** to select "Antenna", then press **[ENTER]**.

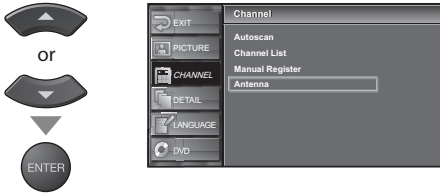

• Use **[the Number buttons]** or **[CH ▲/▼]** to select the channel for which you want to check signal strength.

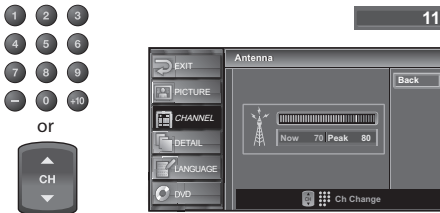

• If the channel is set to external input, you cannot confirm the antenna situation.



4 To exit the setup, press **[SETUP]**.



## ✓ LANGUAGE SELECTION

You can choose English, Spanish, or French as your on-screen menu language.

1 Press **[SETUP]** to display the setup screen.



2 Use **[▲/▼]** to select "LANGUAGE", then press **[ENTER]**.



3 Use **[▲/▼]** to select your language, then press **[ENTER]**.



4 To exit the setup, press **[SETUP]**.





## ✓ CHANNEL SELECTION

Select channels by pressing [CH ▲/▼] found on remote control or [CHANNEL ▲/▼] on the TV's control panel, or by pressing [the Number buttons] found on the remote control.

### [CH ▲/▼]

Use [CH ▲/▼] to change the channel.



- The same operation is available with [CHANNEL ▲/▼] on the control panel of the main unit.

### [the Number buttons]

Press the channel number with [the Number buttons] to select a channel you want to watch, then press [ENTER].

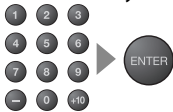

- When selecting analog channel 12



- When selecting digital channel 12-1

Be sure to press [-] before entering the minor channel number.



- If the channel broadcasts NTSC and ATSC both and you do not press [-], you will receive the NTSC channel only. The moment you press [-], the lowest memorized digital channel will be displayed.
- Press [CH RETURN] to return to the previously viewed channel.

### NOTE:

• In DTV broadcasting, one channel sometimes broadcasts multiple programs depending on the air time. In this case, the main channel is called major channel and the minor channel is called minor channel.

### About minor channel broadcasting:

There may be different programs being broadcast on minor channels through a single channel from ATSC. You can watch each minor channel program being broadcast by selecting one of the minor channels.

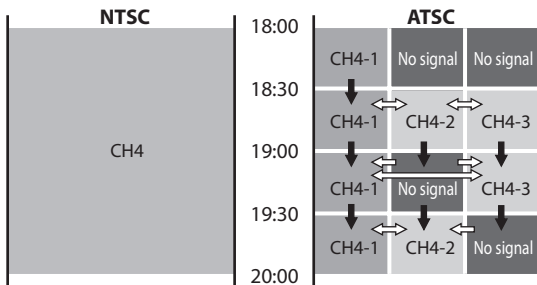

➡ : change automatically

⇔ : change manually by using [CH ▲/▼]

### NOTE:

• "No Signal" will appear on the screen after the minor channel broadcast is over.

## ✓ VOLUME ADJUSTMENT

This section describes how to adjust the volume. The mute function, which turns the sound off and on, is also described.

### [VOL. ▲/▼]

Use [VOL. ▲/▼] to adjust the audio volume.



- The volume bar will be displayed at the bottom of the screen when adjusting the volume.
- The volume bar display will automatically disappear in a few seconds.
- The same operation is also available with [VOLUME ▲/▼] on the control panel of the main unit.

### [MUTE]

Press [MUTE] to turn off and on the sound.



- "Mute" is displayed on the screen for a few seconds.

Press [MUTE] again or [VOL. ▲/▼] ([VOLUME ▲/▼]) to release the Mute status.

## ✓ SELECTING AUDIO CHANNELS

This section describes how to switch the audio in the analog mode and how to switch the audio language in the digital mode.

TV

- 1 Press **[AUDIO]** to display the currently selected audio mode.



- 2 Press **[AUDIO]** to cycle through available audio channels.



- When the broadcasting has all audio...



- When the broadcasting has stereo and monaural audio...



- When the broadcasting has SAP and monaural audio...



- When the broadcasting has only monaural audio...



(The audio cannot be switched.)

- STEREO** : Outputs stereo-audio  
**SAP** : Outputs second audio program  
**MONO** : Outputs mono-audio

DTV

- 1 Press **[AUDIO]** to display the currently selected language and the number of available languages.



- 2 Press **[AUDIO]** to cycle through available audio languages.

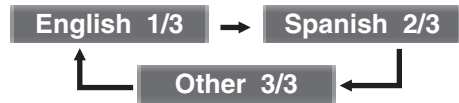

- Available languages differ depending on the broadcast.
- The information display will automatically disappear in 1 minute.

**NOTE:**

- Pressing **[AUDIO]** does not control external audio source.

## ✓ ACCESSING EXTERNAL DEVICES

Use your remote control to access DVD recorders, home audio systems and other external devices when they are connected to your television.

Use your remote control to select external component.

- When you press **[INPUT SELECT]** or **[CH ▼]** on the remote control, the Input Mode will be switched as below.

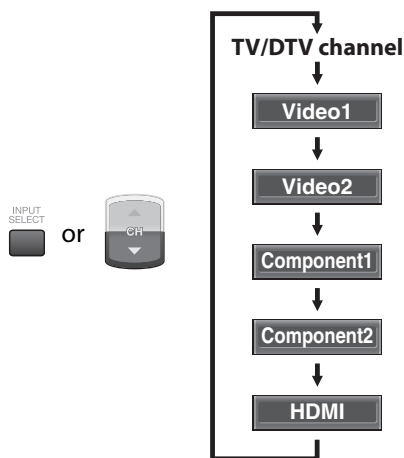

- Pressing **[CH ▲]** on the remote control reverses direction.
- To use the VIDEO1 or S-VIDEO1 input jack on the TV, select "Video1".
- To use the VIDEO2 or S-VIDEO2 input jack on the TV, select "Video2".
- To use the COMPONENT1 input jacks on the TV, select "Component1".
- To use the COMPONENT2 input jacks on the TV, select "Component2".
- To use the HDMI IN jack on the TV, select "HDMI".
- The information display will automatically disappear in 1 minute.

## ✓ SCREEN INFORMATION

You can display the currently selected channel or other information such as the audio mode on the screen.

### TV

In the analog mode, the current channel and the audio mode are displayed.

Press **[INFO]**.



- The current channel number, audio mode, type of resolutions for video signal, TV aspect ratio, CC and TV rating are displayed at the top-right of the screen.
- To clear the display, press **[BACK/RETURN]** or **[INFO]** again.

### DTV

In the digital mode, the detailed information for the current channel such as the Program guide is displayed.

Press **[INFO]**.



- The following information is displayed.
  - (1) Program title
  - (2) Broadcast station
  - (3) Program guide (max. 4 lines displayed)
  - (4) Channel number
  - (5) Audio language ("Other" is displayed when the audio language cannot be acquired, or the acquired languages are other than English, Spanish or French.)
  - (6) Effective scanning lines and scan mode
  - (7) Program definition
  - (8) Program aspect ratio
  - (9) Program rating
  - (10) CC (not available if the CC set to "Off")

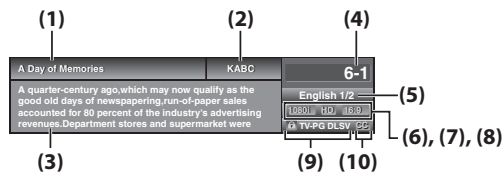

### NOTE:

- When the program guide consists of more than 4 lines, use **[▲/▼]** to scroll.
- "No description provided" is displayed when the program guide is not provided.
- In external input mode, the following screen is displayed: e.g.) If the external device is connected to VIDEO1 input jacks



## ✓ CHANGING THE SCREEN DISPLAY MODE

Each of four display modes can be selected in either 4:3 or 16:9 aspect ratios.

1 Press **[SCREEN MODE]** to switch the TV aspect ratio.



2 Press **[SCREEN MODE]** repeatedly to return to the normal screen displays.



**NOTE:**

• Some programs may not offer all display mode options.

• When the broadcast is sending 4:3 video signal:

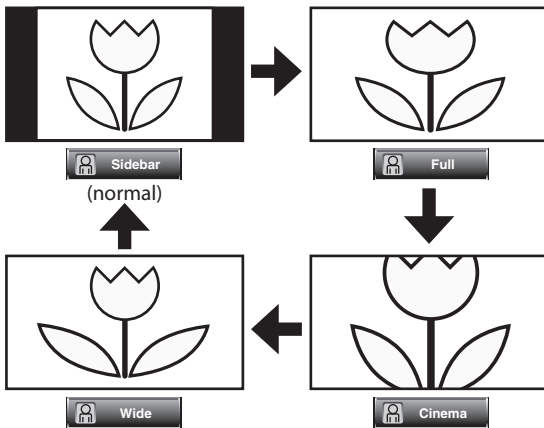

**[Sidebar]**

Sidebar displays a 4:3 picture at its standard 4:3 size. Sidebars will be displayed on the right and left edges of the screen.

**[Full]**

Full displays a 4:3 picture at a 16:9 size, with horizontal elongation necessary to fill the screen.

**[Cinema]**

Cinema displays a 4:3 picture at a 16:9 size, with less horizontal elongation necessary to fill the screen because a little bit of the top and bottom edge of the screen will be cut off.

**[Wide]**

Wide displays the center of the picture as original size and the outer sides of the picture will be elongated. The size of the picture will depend on the original signal.

• When the broadcast is sending 16:9 video signal:

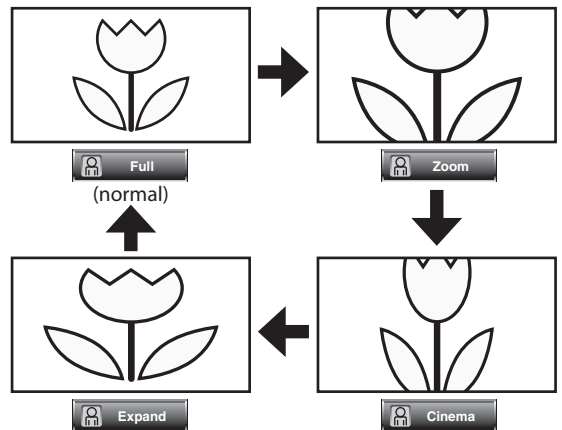

**[Full]**

A picture is displayed at 16:9 size as it is.

**[Zoom]**

Zoom displays a 16:9 picture without changing its horizontal and vertical ratio, at its maximum size.

**[Cinema]**

Cinema displays a 16:9 picture with vertical elongation.

**[Expand]**

Expand displays a 16:9 picture with horizontal elongation.

## ✓ SLEEP TIMER

The Sleep Timer can be set to automatically turn off your television after an incremental period of time.

- 1 Press **[SLEEP]** on the remote control to set the Sleep Timer.



- The setting display for Sleep Timer is shown on the screen.

- 2 You can set your TV to turn off after a set period of time (from 10 to 90 minutes). After set up, you can display the remaining time before shut off by pressing **[SLEEP]** again.

- To cancel the sleep timer, press **[SLEEP]** repeatedly until "Sleep Off" is displayed.



- The Sleep Timer setting display will automatically disappear in a few seconds.

### NOTE:

- When you disconnect your TV from its power source or when a power failure occurs, the sleep timer setting will be canceled.

## ✓ SETUP SCREEN

This section describes the overview of the setup screen displayed when you press **[SETUP]**.

For more details, see the reference page for each item.

The setup screen consists of the function setting items below.

Press **[SETUP]**.



To exit settings.



You can adjust the picture quality (Picture Mode, Brightness, Contrast, Color, Tint, Sharpness, Color Temp., and Energy Saving).  
(Refer to "PICTURE ADJUSTMENT" on page 22.)



You can automatically scan the viewable channels and remove those that are undesired.  
(Refer to "AUTOSCAN" on page 14.)



You can change closed captioning display formats and font styles.

(Refer to "CLOSED CAPTION" on page 23.)

Block children's access to programming.

(Refer to "V-CHIP" on page 26.)

And select HDMI Audio if your TV is connected to a digital external device like a DVD recorder.

(Refer to "HDMI AUDIO" on page 28.)



You can change the language (English, Spanish, French) displayed on the setup screen.

(Refer to "LANGUAGE SELECTION" on page 16.)



You can change the setup of built-in DVD player. Make sure the unit is in DVD mode and the player is in stop mode.

(Refer to "SETTING DVD" on page 40.)

### NOTE:

- To cancel the setup screen, press **[SETUP]**.

## ✓ PICTURE ADJUSTMENT

You can select from four default picture color settings. You can also adjust brightness, contrast, color, tint, sharpness and color temperature as well as energy saving settings.

1 Press **[SETUP]** to display the setup screen.

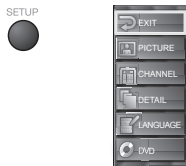

2 Use **[▲/▼]** to select "PICTURE, then press **[ENTER]**.



3 Use **[▲/▼]** to select the picture quality you want to adjust, then press **[ENTER]**.

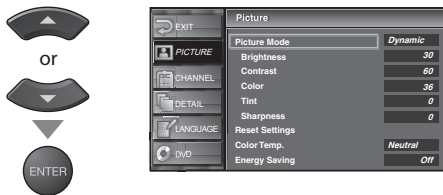

4 Adjust your desired Picture as you prefer.

**Picture Mode** Use **[▲/▼]** to select Picture Mode from the selection, then press **[ENTER]**. (Standard, Dynamic, Movie and News)



**Brightness** Use **[◀/▶]** to adjust until the darkest parts of the picture are as bright as you prefer.

◀: To decrease brightness  
▶: To increase brightness

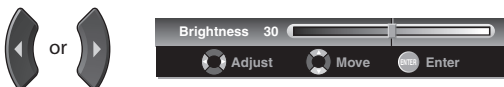

**Contrast** Use **[◀/▶]** to adjust Contrast to be increased or decreased.

◀: To decrease contrast  
▶: To increase contrast

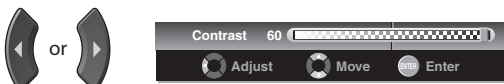

**Color** Use **[◀/▶]** to adjust Color to be brilliant or pale.

◀: To pale ▶: To brilliant

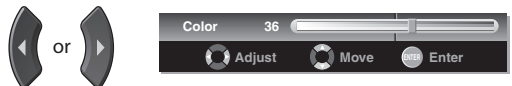

**Tint** Use **[◀/▶]** to adjust Tint to be obtained natural skin tones.

◀: To red ▶: To green

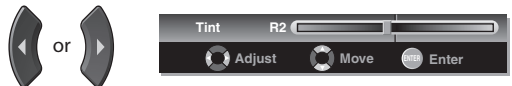

**Sharpness** Use **[◀/▶]** to adjust the detail of the picture.

◀: To soft ▶: To clear

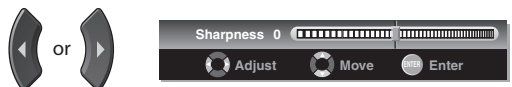

**Reset Settings** Use **[▲/▼]** to select "Reset". So you can reset the Picture Mode as the factory default.

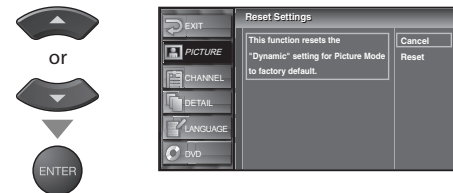

**Color Temp.** Use **[▲/▼]** to adjust Color Temperature from the selection, then press **[ENTER]**. (Cool, Neutral and Warm)

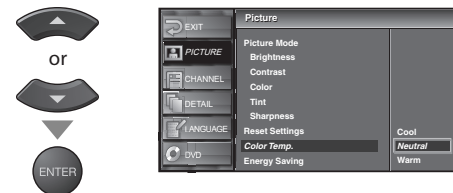

**Energy Saving** Use **[◀/▶]** to adjust brightness of backlight.

◀: To dark ▶: To bright

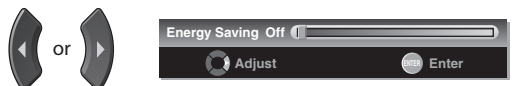

• The adjustment bar for picture quality item is displayed on the screen.

**NOTE:**  
• To cancel the picture adjustment, press **[SETUP]**.

5 To exit the setup, press **[SETUP]**.



## ✓ CLOSED CAPTION

You can view closed captioning (cc) for TV programs, movies, news, and prerecorded tapes. Closed captions refer to text of dialogue or descriptions displayed on-screen for the hearing impaired.

1 Press **[SETUP]** to display the setup screen.

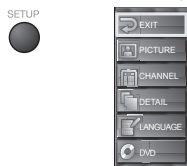

2 Use **[▲/▼]** to select "DETAIL", then press **[ENTER]**.



3 Use **[▲/▼]** to select "Closed Caption", then press **[ENTER]**.



4 Use **[▲/▼]** to select "Conventional CC", then press **[ENTER]**.

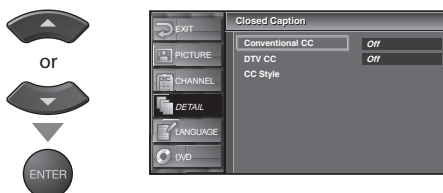

5 Use **[▲/▼]** to select the desired closed caption mode, then press **[ENTER]**.

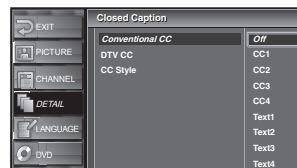

### [Caption Mode]

#### CC1 and Text1:

are the primary caption and text services.

The captioning or text is displayed in the same language as the program's dialogue

(up to 4 lines of script on the screen, where it does not obstruct relevant parts of the picture).

#### CC3 and Text3:

serve as the preferred data channels.

The captioning or text is often a secondary language translation, simplified English or displayed at a slower rate.

#### CC2, CC4, Text2 and Text4:

are rarely available and broadcasters use them

only in special conditions, such as when CC1 and CC3 are not available or Text1 and Text3 are not available.

• There are three display modes according to programs:

**Paint-on mode:** Displays input characters on the screen immediately.

**Pop-on mode :** Once characters are stored in memory, they are displayed all at once.

**Roll-up mode :** Displays the characters continuously by scrolling (max. 4 lines).

6 To exit the setup, press **[SETUP]**.



### NOTE:

- Closed captions must be broadcast or included in your recorded content to appear on your TV.
- Closed captions will not be displayed when you are using an HDMI connection.
- If the closed caption is not in the TV broadcasting, nothing is displayed.
- When your TV receives a special effects playback signal (i.e., Search, Slow and Still) from a VCR's video output channel (CH3 or CH4), the TV may not display the correct caption or text.
- Captions and texts may not match the TV voice exactly.
- Interference may cause the closed caption system not to function properly.
- The caption or text characters will not be displayed while the menu display or functions display is shown.
- If a black box appears on the screen, this means that the TV is set to TEXT mode. To clear screen, select CAPTION "CC1", "CC2", "CC3", "CC4" or "Off".

## ✓ DTV CLOSED CAPTION

DTV

Apart from closed captions, DTV has its own closed captions called DTV CC. Use this menu to change the settings for DTV CC.

1 Press **[SETUP]** to display the setup screen.

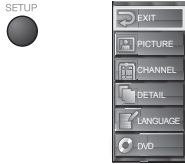

2 Use **[▲/▼]** to select "DETAIL", then press **[ENTER]**.



3 Use **[▲/▼]** to select "Closed Caption", then press **[ENTER]**.



4 Use **[▲/▼]** to select "DTV CC", then press **[ENTER]**.

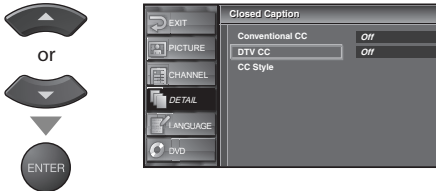

5 Use **[▲/▼]** to select the desired DTV Closed Caption, then press **[ENTER]**.

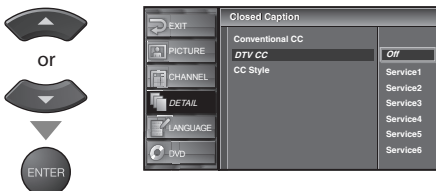

**Off:**

Select if you do not want DTV CC. This is the default.

**Service 1 to Service 6:**

Select one of these before changing any other item in the Closed Caption menu. Choose "Service1" under normal circumstances.

6 To exit the setup, press **[SETUP]**.



## ✓ CLOSED CAPTION STYLE

DTV

DTV can also change the style of its Closed Caption such as font, color or size, etc.

1 Press **[SETUP]** to display the setup screen.



2 Use **[▲/▼]** to select "DETAIL", then press **[ENTER]**.



3 Use **[▲/▼]** to select "Closed Caption", then press **[ENTER]**.



4 Use **[▲/▼]** to select "CC Style", then press **[ENTER]**.

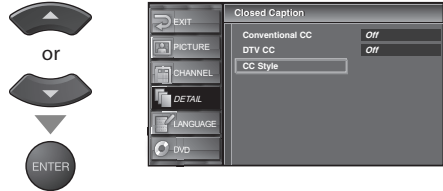

5 Use **[▲/▼]** to select "User Setting", then press **[ENTER]**.

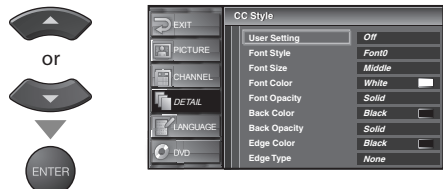



6 Use [▲/▼] to select "On", then press [ENTER].



7 Use [▲/▼] to select the item and switch the setting for each item you want to set, then press [ENTER].

- When "User Setting" is set to "On", you can set the following items. CC style set by "User Setting" will be displayed.
- The setting description for each item is shown below.

**[Font Style]**

Font style of the displayed caption can be switched as below.



**[Font Size]**

Closed Captioning font style can be changed as below.



**[Font Color]**

Font color of the displayed caption can be switched as below.



**[Font Opacity]**

Font opacity of the displayed caption can be switched as below.

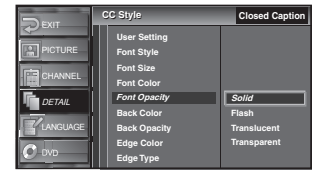
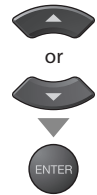

**[Back Color]**

Background color of the displayed caption can be switched as below.

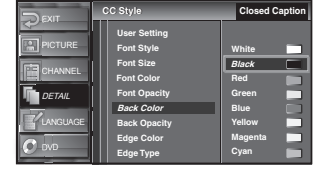
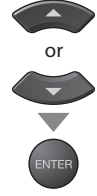

**[Back Opacity]**

Background opacity of the displayed caption can be switched as below.

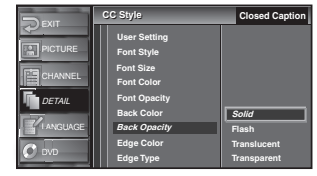
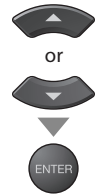

**[Edge Color]**

Edge color of the displayed caption can be switched as below.

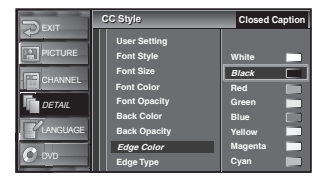
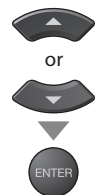

**[Edge Type]**

Edge type of the displayed caption can be switched as below.

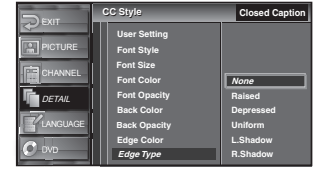
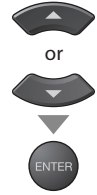

8 To exit the setup, press [SETUP].



## ✓ V-CHIP

You can block certain programming inappropriate for children. This block can be released by entering a password.

1 Press **[SETUP]** to display the setup screen.

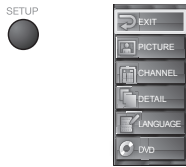

2 Use **[▲/▼]** to select "DETAIL", then press **[ENTER]**.



3 Use **[▲/▼]** to select "V-chip", then press **[ENTER]**.

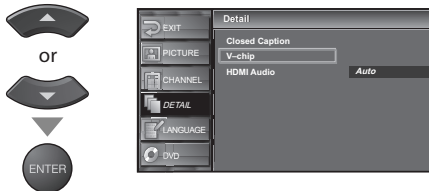

• The password entry screen is displayed.



4 Use **[the Number buttons]** to enter the 4-digit numbers for your password.



- When you have not set up your password, enter 0000.
- When the password is correct, the following "V-Chip" screen is displayed.

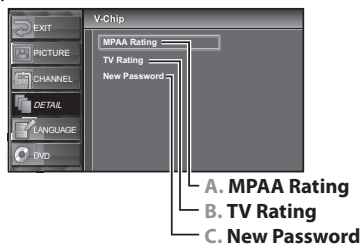

See the following description for setting each item.

## A. MPAA Rating

5 Use **[▲/▼]** to select "MPAA Rating", then press **[ENTER]**.



• The current setting is displayed.



6 Use **[▲/▼]** to select the desired rating, then press **[ENTER]** to switch between "View" and "Block".



• The  icon appears when the rating is blocked.

7 To exit the setup, press **[SETUP]**.



<Selection>	<Rating Category Explanations>
<b>X</b> :	Mature audience only
<b>NC-17</b> :	No one under 17 admitted
<b>R</b> :	Restricted; under 17 requires accompanying parent or adult guardian
<b>PG-13</b> :	Unsuitable for children under 13
<b>PG</b> :	Parental Guidance suggested
<b>G</b> :	General Audience
<b>NR</b> :	No Rating

### NOTE:

- When you select a rating and set it to "Block", the higher ratings will be blocked automatically. The lower ratings will be available for viewing.
- When you set "X" to "View", all ratings turn to "View" automatically.

## B. TV Rating

5 Use **[▲/▼]** to select “TV Rating”, then press **[ENTER]**.



• The current setting is displayed.

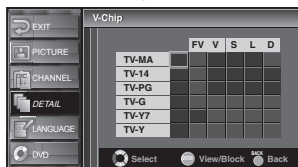

### <Selection> <Rating Sub Category Explanations>

<b>FV</b> :	Fantasy Violence
<b>V</b> :	Violence
<b>S</b> :	Sexual Situation
<b>L</b> :	Coarse Language
<b>D</b> :	Suggestive Dialogue

### NOTE:

- When you select a rating and set it to “Block”, the higher ratings will be blocked automatically. The lower ratings will be available for viewing.
- When you set “TV-MA” to “View”, all ratings turn to “View” automatically.

6 Use **[▲/▼/◀/▶]** to select the desired rating, then press **[ENTER]**.

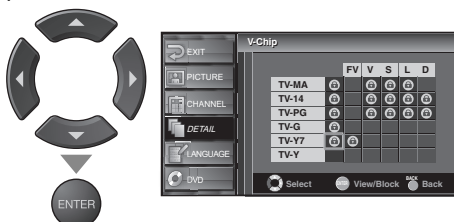

• Press **[ENTER]** to switch between “View” and “Block” for the rating without sub categories.

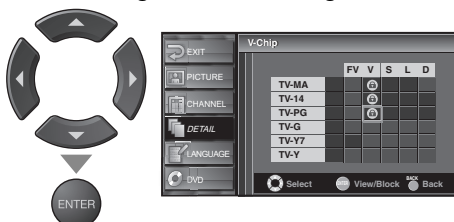

• For the rating with sub categories, use **[▲/▼/◀/▶]** and select the desired rating, then press **[ENTER]** to switch between “View” and “Block”.

7 To exit the setup, press **[SETUP]**.



### <Selection> <Rating Category Explanations>

<b>TV-MA</b> :	Mature audience only
<b>TV-14</b> :	Unsuitable for children under 14
<b>TV-PG</b> :	Parental Guidance suggested
<b>TV-G</b> :	General Audience
<b>TV-Y7</b> :	Appropriate for children 7 and older
<b>TV-Y</b> :	Appropriate for all children

## C. New Password

- 5 Use [**▲/▼**] to select “New Password”, then press [**ENTER**].



- 6 Press [**the Number buttons**] on the remote control to enter the new 4-digit password.  
 • Enter password again in “Confirm password.” space.



- 7 To exit the setup, press [**SETUP**].



### NOTE:

- Make sure to enter the exact same new password as the “Confirm password.”. If they are different, the space is cleared for reentering.
- Your password will be erased and return to the default (0000) when a power failure occurs or when you turn off the power using a wall switch. If you forget the password, unplug the power cord for 10 seconds to restore the password to 0000.

## ✓ HDMI AUDIO

Set the method of sound input for HDMI jack.

- 1 Press [**SETUP**] to display the setup screen.

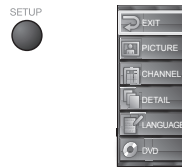

- 2 Use [**▲/▼**] to select “DETAIL”, then press [**ENTER**].



- 3 Use [**▲/▼**] to select “HDMI Audio”, then press [**ENTER**].

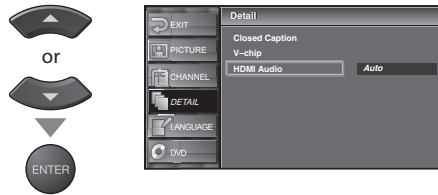

- 3 Use [**▲/▼**] to select the desired HDMI audio setting, then press [**ENTER**].



- Select “Auto” if you connected to both digital device with HDMI jack and analog device for audio sources. Digital audio input signal has priority in this setting.
- Select “Digital” if you connected to digital device with HDMI jack for digital audio input signal.
- Select “Analog” if you connected to analog device with analog jacks for analog audio input signal.

- 4 To exit the setup, press [**SETUP**].



## DVD FUNCTIONS

### ✓ PLAYABLE MEDIA

Playable media	Mark (logo)	Region code	Recorded signals	Media size	Disc types
DVD-Video *1, 2, 3, 4, 6, 10			Digital video (MPEG2)	12 cm	
DVD-RW DVD-R *1, 2, 3, 4, 5, 6, 7, 8, 9, 10		—			
DVD+RW DVD+R *1, 3, 4, 5, 7, 8, 9, 10		—			
Audio CD *4, 6, 10		—	Digital audio	12 cm	
CD-RW CD-R *4, 5, 6, 9, 10		—	Digital audio or MP3 or JPEG		

**DVD** is a trademark of DVD Format/Logo Licensing Corporation.

#### If you cannot play back a disc which bears one of the marks above, check the following notes.

- \*1: This unit conforms to the NTSC color system. Discs recorded in other color system such as PAL cannot be played back.
- \*2: Certain DVD-Video discs do not operate as described in this manual due to the intentions of the disc's producers.
- \*3: Discs recorded in VR (Video Recording) format cannot be played back.
- \*4: Scratched or stained discs may not be played back.
- \*5: Some discs cannot be played back because of incompatible recording conditions, characteristics of the recorder or special properties of discs.
- \*6: You can play back discs which bear the marks above. If you use non-standardized discs, this unit may not play them back. Even if they are played back, the sound or video quality will be compromised.
- \*7: Depending on the recording status of a disc, the disc may not be played back at all or normally (the picture or sound may not be smooth, etc.). In this case, you need to finalize the disc with the DVD recorder. Refer to the manual accompanying the DVD recorder.
- \*8: Only the discs recorded in the video mode and finalized can be played back. Unfinalized discs cannot be played back. Depending on the recording status of a disc, the disc may not be played back at all or the picture or sound may not be smooth, etc.
- \*9: If the recorded portion of the disc is too small (less than 55 mm across), it may not play back properly.
- \*10: Do not glue paper or put stickers on to the disc. These may damage the disc, and the unit may not read it correctly.

### ✓ UNPLAYABLE MEDIA

- **NEVER play back the following discs. Otherwise, malfunction may result!**  
DVD-RAM / DVD-Audio / CD-i / Photo CD / Video CD / DVD with region codes other than 1 or ALL / DTS-CD / DVD-ROM for personal computers / CD-ROM for personal computers
- **On the following disc, the sound MAY NOT be heard.**  
Super Audio CD

**NOTE:**

• Only the sound recorded on the normal CD layer can be delivered. The sound recorded on the high density Super Audio CD layer cannot be delivered.

- **Any other discs without compatibility indications**

These operations are accessible by remote control. Some may also be accessible by controls on the main unit.

## ✓ **PLAYBACK**

**DVD** **CD** **(MP3)** **(JPEG)** on page 32)

### **Before:**

Turn on the amplifier and any other equipment which is connected to this unit.

Make sure the external audio receiver (not included) are set to the correct channel.

**1** Press **[POWER]** to turn on the unit.



**2** Insert a disc with label facing left from the right side of the unit.

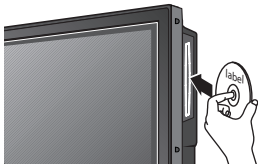

**3** The unit switches to the DVD mode when the unit was in TV mode and detects the type of disc.



• Press **[PLAY ▶]** if the unit does not go to the DVD mode.

**4** The disc starts playback.

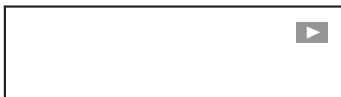

**5** Press **[STOP ■]** to stop playback.



**6** Press **[EJECT]** to eject the disc.



### **NOTE:**

- When you play an MP3 or a JPEG-format disc, details on page 32.
- A "prohibited icon" may appear at the top-right on the TV screen when the operation is prohibited by the disc or this unit. 
- Some DVDs may start playback from title 2 or 3 due to specific programs.
- During the playback of a 2-layered disc, pictures may stop for a moment. This happens while the 1st layer is being switched to the 2nd layer. This is not a malfunction.

## ✓ **DVD MENU**

**DVD**

Some DVDs contain menus which allow you to customize DVD playback.

- Press **[DISC MENU]** and, use **[▲ / ▼ / ◀ / ▶]** to select an item, then press **[ENTER]** (or **[PLAY ▶]**).

### Calling up a Menu screen during playback

- Press **[DISC MENU]** to call up the DVD menu.
- Press **[TITLE]** to call up the title menu.

#### **NOTE:**

- Menu operations may vary depending on the disc. Refer to the manual accompanying the disc for more details.

## ✓ **RESUME**

**DVD** **CD** **(MP3)** **(JPEG)**

Press **[STOP ■]** during playback.

Resume message will appear on the TV screen.

Press **[PLAY ▶]** to start resume playback where you left off.

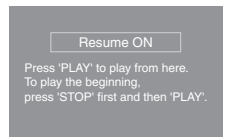

#### **NOTE:**

- To cancel resume information, press **[STOP ■]** again in the stop mode. On some discs, **[STOP ■]** will not work while the resume message appears. Please wait until the message disappears.
- The resume information will be kept even when unit is in standby mode. For MP3 and JPEG, playback will resume from the beginning of the track at which playback was stopped.

## ✓ **PAUSED AND STEP-BY-STEP PLAYBACK**

**DVD** **CD** **(MP3)** **(JPEG)**

Press **[PAUSE II]** during playback.

• Playback will be paused and sound will be muted.

- Press **[PAUSE II]** once during Dual/Folder playback to pause a JPEG file only. Press **[PAUSE II]** one more time to pause an MP3 track. 

To continue playback, press **[PLAY ▶]**.

**DVD**

The disc goes forward one frame at a time.

**[PAUSE II]** is pressed in the pause mode.

To continue playback, press **[PLAY ▶]**.

#### **NOTE:**

- Set "STILL MODE" to "FIELD" in the "OTHERS" setting if pictures in the pause mode are blurred. (Refer to page 43.)

## ✓ FAST FORWARD / FAST REVERSE

DVD CD MP3

Press **[FWD ►►]** or **[REV ◀◀]** repeatedly during playback to select the required forward or reverse speed.



To continue playback, press **[PLAY ►]**.

### NOTE:

- Set "STILL MODE" to "FIELD" in the "OTHERS" setting if pictures in the fast playback mode are blurred. (Refer to page 43.)
- Fast forward or reverse search speed is varies with disc. Approximate speed is 1(2X), 2(8X), 3(20X), 4(50X) and 5(100X) on DVDs and 1(2X), 2(8X) and 3(30X) on Audio CDs and MP3.
- For Audio CDs and MP3, sound will be output during Fast forward or reverse search.

## ✓ SLOW FORWARD / SLOW REVERSE

DVD

Use **[FWD ►►]** or **[REV ◀◀]** repeatedly during the pause mode to select the required forward or reverse speed.



To continue playback, press **[PLAY ►]**.

### NOTE:

- Slow forward or reverse speed varies with disc. Approximate speed is 1(1/16X), 2(1/8X) and 3(1/2X).
- Set "STILL MODE" to "FIELD" in the "OTHERS" setting if pictures in the slow playback mode are blurred. (Refer to page 43.)

## ✓ ZOOM

DVD JPEG

The zoom function allows you to enlarge the video image and to pan through the enlarged image.

### 1 During playback, press **[ZOOM]**.

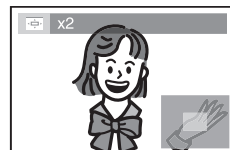

- The picture becomes twice as large.

### 2 Press **[ZOOM]** repeatedly to change the required zoom factor; "x2", "x4" or "OFF".



### 3 Once a desired zoom factor is set, use **[▲ / ▼ / ◀ / ▶]** to slide the zoomed picture across the screen.

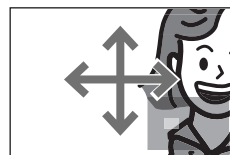

### 4 To exit zoom function, press **[ZOOM]** repeatedly to select "OFF".



### NOTE:

- Zooming function does not work while the disc menu is displayed.
- 4X zoom is not available on some discs.
- Only 2X zoom is available on JPEG files.
- Zoom function is also available during pause mode.
- Position guide is not available for JPEG files.

## ✓ MP3, JPEG PLAYBACK

MP3

JPEG

MP3 or JPEG is a method of compressing files. You can copy MP3 or JPEG files on CD-RW/-R discs from the Personal Computer and play the files on this unit.

- 1 Insert an MP3 or JPEG-format disc, playback starts automatically.
  - Press **[PLAY ▶]** if MP3 or JPEG-format disc is already inserted.
  - Press **[DISC MENU]** when you want to call up the FILE LIST.

### When selecting the folder:

- Press **[▶]** when you want to go to the next hierarchy.

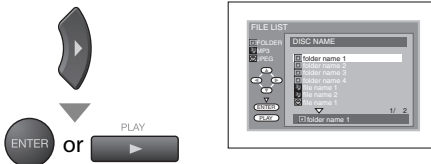

- Press **[◀]** when you want to go back to the previous hierarchy (except for the top hierarchy).
- If **[TITLE]** is pressed when a FILE LIST is displayed, the 1st item in the top hierarchy will be highlighted.
- Press **[DISC MENU]** or **[BACK/RETURN]** to go back to playback display.

- 2 Press **[STOP ■]** once to stop playback temporarily.



- Refer to "RESUME" on page 30.

### NOTE:

- Some selections may take a while to be recognized.
- Folders are known as Groups; files are known as Tracks.
- Folders, MP3 files and JPEG files are displayed respectively as , and .
- A maximum of 255 folders or 999 files may be recognized in one disc.
- Up to 8 hierarchies can be recognized in one folder. Files in the 9th or deeper hierarchies cannot be played back.
- This unit can play back images and sounds from data recorded in MP3 and JPEG formats on CD-RW/-R discs.
- A file with an extension of ".mp3 (MP3)" is called an "MP3 file".
- A file with an extension of ".jpg (JPG)" or ".jpeg (JPEG)" is called a "JPEG file".
- The unit can run an image file conforming to the Exif specification. Exif is a file format, Exchangeable Image File format established by Japanese Electronic Industry Development Association (JEIDA).
- Files whose extension is other than ".mp3 (MP3)", ".jpg (JPG)" and ".jpeg (JPEG)" will not be listed in the MP3 or JPEG menu.
- If the file is not recorded in MP3 or JPEG format, noise may be produced even if the file extension is either ".mp3 (MP3)", ".jpg (JPG)" or ".jpeg (JPEG)".
- The name of group and track can be displayed in up to 25 characters. Unrecognizable characters will be replaced with asterisks.
- Unplayable groups or tracks may be displayed depending on the recording conditions.
- Progressive JPEGs (JPEG files saved in the progressive format) will not play on this unit.

This unit recommends the files recorded under the following circumstances:

Applicable MP3 file	Remarks
Sampling frequency: 44.1 kHz or 48 kHz	For MP3 file recorded in Variable Bit Rate (VBR), the unit may not display the actual elapsed time.
Constant bit rate: 32 kbps ~ 320 kbps	

Applicable JPEG file	Remarks
Normal playback Upper limit: 6,300 x 5,100 dots Lower limit: 32 x 32 dots File size: Max. 7 MB	A JPEG image that extends beyond the screen is reduced so that it will be displayed within the screen.
Dual playback Upper limit: 5,000 x 5,000 dots Lower limit: 32 x 32 dots File size: Max. 5 MB	

## ✓ DUAL PLAYBACK

MP3

JPEG

This function lets you play back MP3 and JPEG files simultaneously. Available only when "Dual Playback" is "ON". See page 43 on how to set the Dual Playback ON or OFF.

- 1 Press **[PLAY ▶]**, then press **[DISC MENU]**.

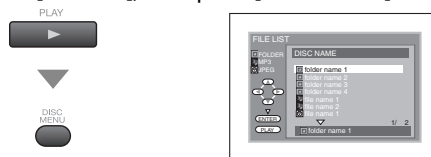

- 2 When playing back an MP3 file, use **[▲ / ▼]** to select a desired JPEG file from the FILE LIST, then press **[ENTER]** (or **[PLAY ▶]**).



- When playing back a JPEG file, select an MP3 file.

### NOTE:

- To cancel Dual Playback, press **[DISC MENU]** again at step 1.
- If you press **[PLAY ▶]** directly after you inserted a disc which contains both MP3 tracks and JPEG files and if the "DUAL PLAYBACK" setting is "ON", Dual Playback will start automatically.
- If you press **[FWD ▶▶]** or **[REV ◀◀]** during Dual Playback, a JPEG file will be paused.
- Zooming or rotating a JPEG file during Dual Playback may cause an intermittent sound.
- Depending on the data size of each file, Dual Playback may not function properly. (Refer to "Applicable JPEG file" on page 32.)



## ✓ FOLDER PLAYBACK

MP3

JPEG

This function lets you play all the files and tracks contained in one selected folder automatically. Available only when "Dual Playback" is "ON". If the folder contains both MP3 and JPEG files, the Dual Playback will begin automatically within that folder. See page 43 on how to set the Dual Playback ON or OFF.

- 1 Press **[STOP ■]**, then press **[MODE]**.

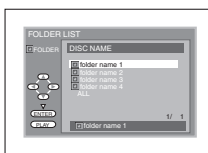

- 2 Use **[▲ / ▼]** to select a desired folder from the FOLDER LIST, then press **[ENTER]** (or **[PLAY ►]**).



### NOTE:

- To cancel Folder Playback, press **[MODE]** again at step 1.
- If you press **[FWD ►►]** or **[REV ◀◀]** during Folder Playback, a JPEG file will be paused.
- Zooming or rotating a JPEG file during Folder Playback may cause an intermittent sound.
- Depending on the data size of each file, Folder Playback may not function properly. (Refer to "Applicable JPEG file" on page 32.)

## ✓ TRANSITION MODE

JPEG

You can switch to the Transition Mode for JPEG files during playback.

- 1 Press **[PLAY ►]**, then press **[MODE]** repeatedly until "**JPG**" appears.

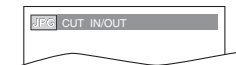

- 2 Use **[ENTER]** or **[◀ / ▶]** to select a desired setting.

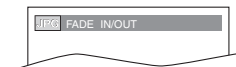

- CUT IN/OUT** : The entire image appears in one time.  
**FADE IN/OUT** : The image appears gradually and then disappears.

- 3 To exit the Transition mode, press **[BACK/RETURN]**.



### NOTE:

- The Transition mode cannot be switched when it is stopped, or from the FILE LIST screen.
- The default setting is "CUT IN/OUT".

## ✓ ADJUSTMENT OF PICTURE SIZE

JPEG

When the overall picture cannot be displayed and the edge of the picture is cut off, you can adjust the size of the JPEG playback image on screen.

- 1 Press **[PLAY ►]**, then press **[MODE]** repeatedly until "**JPG**" appears.



- 2 Use **[ENTER]** or **[◀ / ▶]** to select a desired setting.



**NORMAL** : To display the image at 100% of the picture size.

**SMALL** : To display the image at 95% of the picture size.

- 3 To exit the Picture Adjustment mode, press **[BACK/RETURN]**.



### NOTE:

- The setting screen will not be displayed while in the stop mode or from the FILE LIST.
- This feature may have no effect on some files (e.g. Files with a small picture size).
- The default setting is "NORMAL".

## SEARCH FUNCTIONS

### CHAPTER / TITLE Search

DVD

#### Using [SEARCH MODE]

- 1 Press [SEARCH MODE] once to display the Chapter Search display.

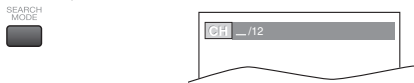

• Press [SEARCH MODE] twice for the Title search ([TT]).

- 2 Press [the Number buttons] to select a desired chapter or title within 30 seconds.

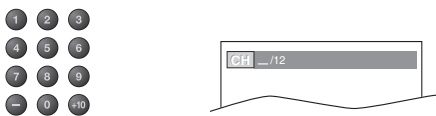

- 3 Playback will start automatically from the chapter or title you searched.

#### Using [SKIP <<<, >>>]

- 1 During playback, press [SKIP <<<, >>>] repeatedly until a desired chapter or title will be selected.

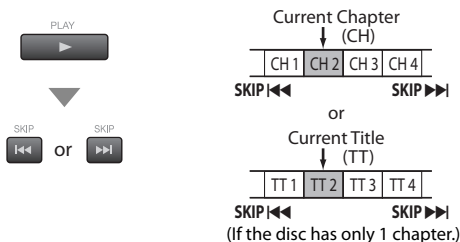

- 2 Playback will start automatically from the chapter or title you searched.

**NOTE:**

- Depending on the disc being played, this function can also be performed by directly entering the desired chapter number with the [the Number buttons]. Refer to the manual accompanying the disc.
- The Chapter or Title Search can only be performed during playback or when the unit has kept the resume information. It cannot be performed in the stop mode.

### TRACK Search

CD

MP3

JPEG

#### Using [SEARCH MODE]

- 1 Press [SEARCH MODE] once to display the Track Search display.

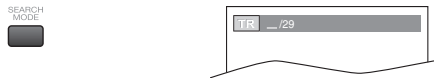

- 2 Press [the Number buttons] to select your desired track within 30 seconds.

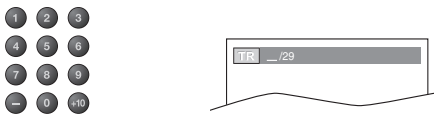

- 3 Playback will start automatically from the track you searched.

**NOTE:**

- The total number of tracks in your disc;
- With less than 10 tracks, press the track number directly.
  - With 10 or more but less than 100 tracks, To play a single digit track, press [0] first, then the track number. e.g.) for track 3, press [0], [3]. To play a double-digit track, press the track number.
  - With 100 or more tracks, To play a single or double digit track, press [0] first, then the track number directly. e.g.) for track 3, press [0], [0], [3], for track 26, press [0], [2], [6]. To play a triple-digit track, press the track number directly.
  - Track Search is not available for Programmed or Random Playback.
  - The Track Search can only be performed during playback or when the unit has kept the resume information. It cannot be performed in the stop mode.

#### Using [SKIP <<<, >>>]

- 1 During playback, press [SKIP <<<, >>>] repeatedly until a desired track will be selected.



- 2 Playback will start automatically from the track you searched.

**NOTE:**

- [SKIP <<< / >>>] are not available when playback is stopped.

## TIME Search

DVD

CD

- 1 During playback, press **[SEARCH MODE]** repeatedly until the "**SEARCH MODE**" appears.



- 2 Press **[the Number buttons]** to select your desired time within 30 seconds.

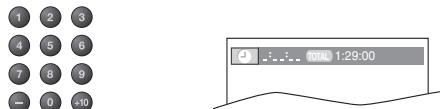

- 3 Playback will start automatically from the time you searched.

### NOTE:

- When there is no need to enter a number, "0" appears automatically. For example, "0: 0\_ : \_" appears in the Time Search display if the total time of the title or track is less than 10 minutes.
- Press **[CLEAR]** to erase the incorrect input at step 2.
- The Time Search can only be performed during playback or when the unit has kept the resume information. It cannot be performed in the stop mode.

## REPEAT PLAYBACK

DVD

CD

MP3

JPEG

Repeat function is available only during playback.

- 1 During playback, press **[REPEAT]** repeatedly until the desired repeat setting.

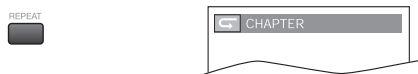

- 2 Each time you press **[REPEAT]**, repeat function changes as example below.

DVD

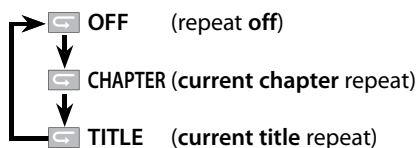

CD

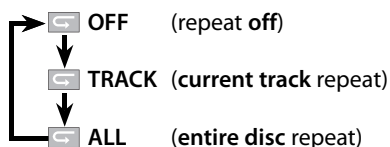

MP3

JPEG

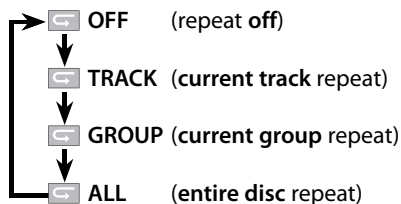

- 3 To exit the Repeat function display, press **[BACK/RETURN]**.



### NOTE:

- Repeat setting (except "ALL") will be cleared when moving to another title, chapter, track or group.
- Repeat playback may not function with some discs or during Repeat A-B Playback.

## ✓ REPEAT A-B PLAYBACK

DVD CD

This feature allows you to assign a specific point on a disc to be called back later.

- 1 During playback, press **[A-B]** at your desired starting point (A).



- 2 Press **[A-B]** at your desired ending point (B).



- Point B should be in the same title or track as point A.

- 3 To exit the sequence, press **[A-B]** so that "OFF" appears.



### NOTE:

- To cancel Point A, press **[CLEAR]** at step 1.
- This function does not work in the other repeat modes.

## ✓ RANDOM PLAYBACK

CD MP3 JPEG

This function shuffles the playing order of tracks instead of playback in the sequence.

- 1 In stop mode, press **[MODE]** twice.

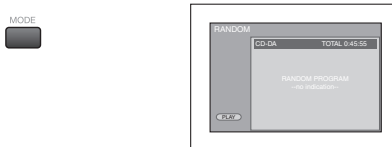

- 2 Press **[PLAY ▶]** to start Random Playback.



### NOTE:

- To repeat the current track in the random selections, press **[REPEAT]** repeatedly until "TRACK" appears during playback.
- To repeat the entire random selections, press **[REPEAT]** repeatedly until "ALL" appears during playback.
- Random Playback of MP3 or JPEG is not available while "Dual Playback" is "ON".
- The Random Playback will be kept until you press **[STOP ■]**.

## ✓ PROGRAMMED PLAYBACK

CD MP3 JPEG

You may determine the order in which tracks will play.

- 1 In stop mode, press **[MODE]** once.

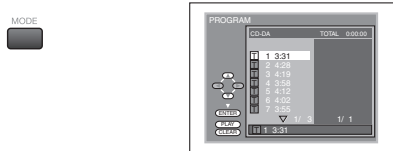

- 2 Use **[▲ / ▼]** to select a desired track from the FILE LIST, then press **[ENTER]** to store.

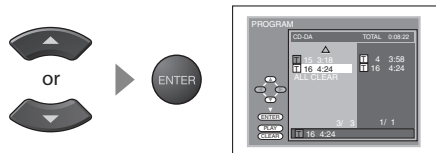

- Up to 99 tracks can be ordered.
- If 8 or more tracks were in a program, use **[SKIP ◀◀ / ▶▶]** to see all the tracks.

While an MP3 or a JPEG folder is open:

- Press **[▶]** when you want to go to the next hierarchy.
- Press **[◀]** when you want to go back to the previous hierarchy (except for the top hierarchy).
- Press **[TITLE]** when you want to go back to the item in the top hierarchy.

- 3 Press **[PLAY ▶]** to start Programmed Playback.

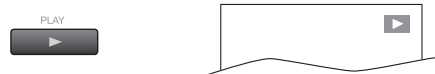

### NOTE:

- Press **[ENTER]** at step 2 to erase the most recently entered track.
- To erase all programmed tracks at once, select "ALL CLEAR" and press **[ENTER]** at step 2.
- While a program is being played back, **[STOP ■]** works as follows:
  - Press **[STOP ■]** and **[PLAY ▶]** next, so that the programmed playback restarts. (CD playback restarts from the current point. MP3 or JPEG playback restarts from the beginning of the current track.)
  - Press **[STOP ■]** and **[PLAY ▶]** next, so that playback restarts from the first track in the original order. However, your programmed playback can be restarted when you follow the above steps. (Your programs are still stored until either the disc is ejected or power is turned off.)
- On some discs, **[STOP ■]** will not work while the Resume message appears. Please wait until the message disappears.
- To repeat the current track in the program, press **[REPEAT]** repeatedly until "TRACK" appears during playback.
- To repeat the entire program, press **[REPEAT]** repeatedly until "ALL" appears during playback.
- Programmed Playback of MP3 or JPEG is not available while "Dual Playback" is "ON".
- The Program Playback will be kept until you press **[STOP ■]** twice and saved the programmed order until the disc is ejected.
- Press **[CLEAR]** to erase the incorrect track number at step 2.

# ON-SCREEN DISPLAY

You can check the information about the current disc by pressing [INFO] on the remote control.

## DVD

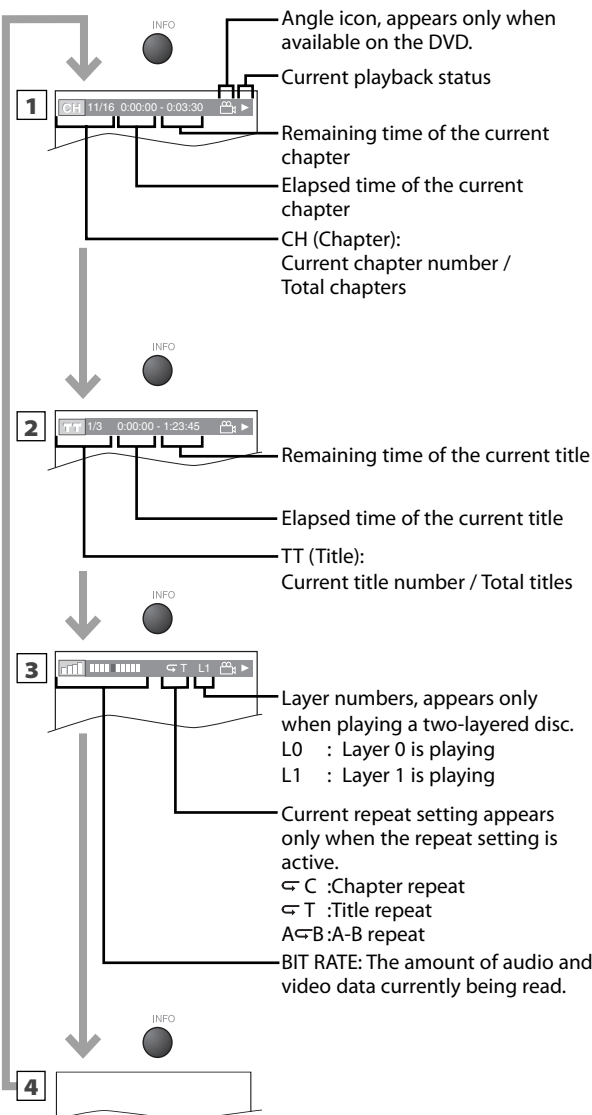

**NOTE:**

- Some DVD discs will not allow you to set chapter playback correctly.

## CD

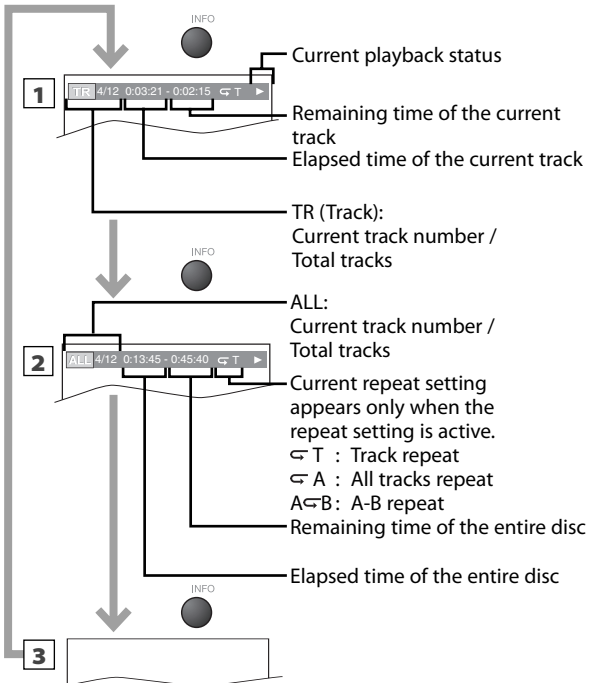

**NOTE:**

- When you are playing a disc in PROGRAM or RANDOM mode, "TR PROGRAM" (or "TR RANDOM") will be displayed instead of 2.

## MP3 JPEG

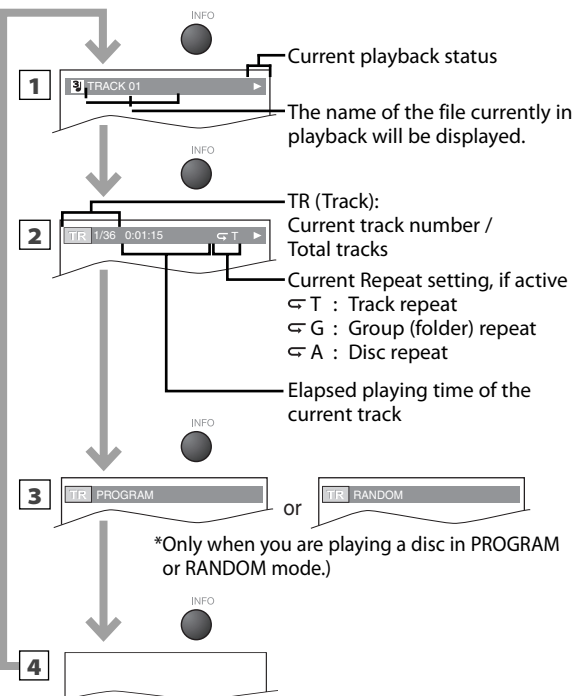

**NOTE:**

- When the "Dual Playback" is "ON", MP3 and JPEG file name will be displayed.

## ✓ SPECIAL SETTINGS

### Subtitle Language

DVD

This unit allows you to select a subtitle language (if available) during DVD playback.

- 1 During playback, press **[SUBTITLE]** repeatedly until the desired language appears.

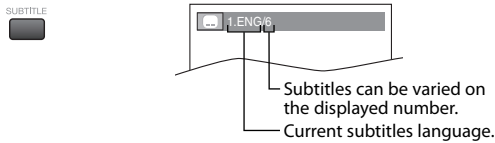

Each time you press **[SUBTITLE]**, the subtitle language changes as example below.

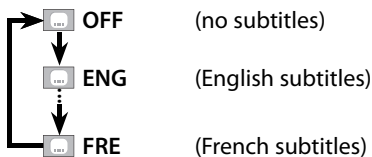

### To cancel the subtitle

- 1 During playback, press **[SUBTITLE]** to display the subtitle display.

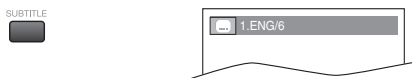

- 2 Press **[▶]** button to set "OFF".

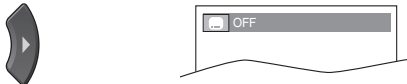

#### NOTE:

- If your language is not shown after pressing **[SUBTITLE]** several times, the disc may not have that language. However, some discs allow you to change subtitle languages setting in the disc menu. (Operation varies depending on the disc, so refer to the manual along with the disc.)
- When "NOT AVAILABLE" appears on the TV screen, it means no subtitle is recorded on the scene.
- If you choose a language that has 3-letter-language code, the code will be displayed every time you change the subtitle language setting. If you choose any other languages, "--" will be displayed instead. (Refer to page 44.)

### Audio Language

DVD

This unit allows you to select an audio language (if multiple languages are available) during DVD playback.

- 1 Press **[AUDIO]** repeatedly until the desired language appears.

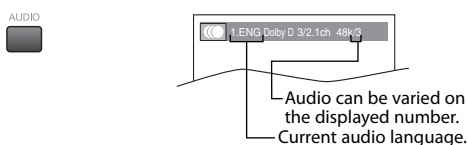

- Each time you press **[AUDIO]**, the audio language changes as example below.

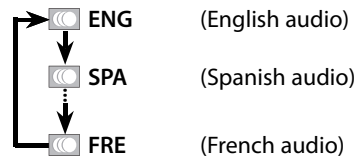

#### NOTE:

- Some discs will only allow you to change the audio setting from the disc menu. Refer to the manual accompanying the discs for details.
- If your language is not shown after pressing **[AUDIO]** several times, the disc may not have that language. However, some discs allow you to change multiple audio languages setting in the disc menu. (Operation varies depending on the disc, so refer to the manual along with the disc.)
- When "NOT AVAILABLE" appears on the TV screen, it means audio language is not available.

### Camera Angles

DVD

Some DVD discs may contain scenes which have been shot simultaneously from various angles. You can change the camera angle if "ANGLE" appears on the screen. If the "ANGLE ICON" setting is "OFF" in the OTHERS menu, "ANGLE" will not appear. (Refer to page 43.)

- 1 During playback, press **[ANGLE]** repeatedly until the desired camera angle appears.

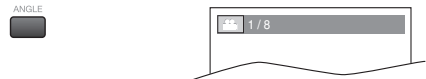

### Black Level Setting

DVD

Adjust the Black Level Setting to make the dark areas of the TV picture brighter.

- 1 During playback, press **[MODE]** repeatedly until the "ANGLE" appears.

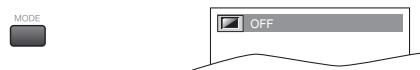

- 2 Press **[ENTER]** to adjust the black level.



- ON** :Makes the dark areas brighter.
- OFF** :Shows the original picture as recorded.

- 3 To exit the Black Level setting, press **[BACK/RETURN]**.



#### NOTE:

- The setting will be kept even if the unit is turned off.

## Stereo Sound Mode

CD

This unit allows you to select a sound mode during CD playback.

- 1 Press **[AUDIO]** repeatedly until the desired sound mode appears.

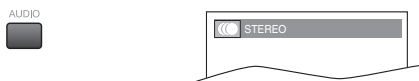

- Each time you press **[AUDIO]**, the audio language changes as example below.

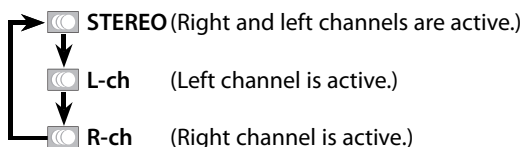

### NOTE:

- Virtual Surround cannot be changed when the sound mode is set to either L-ch or R-ch.

## Virtual Surround

DVD

CD

MP3

You can enjoy virtual surround sound on your existing 2 channel stereo system.

- 1 During playback, press **[MODE]** repeatedly until the "OFF" appears.

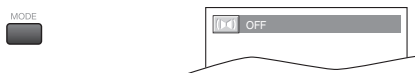

- 2 Press **[ENTER]** to select the sound level.

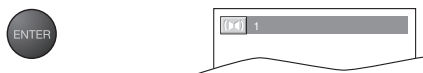

- 1 : Natural effect.
- 2 : Emphasized effect.
- OFF : No effects (original sound).

- 3 To exit the Virtual Surround setting, press **[BACK/RETURN]**.



### NOTE:

- The setting will be kept even if the unit is turned off.
- On Audio CDs, Virtual Surround will not be effective if the sound mode is set to something other than "STEREO". Refer to "Stereo Sound Mode".
- Turn down the level or select "OFF" if the sound is distorted.

## Marker Setup

DVD

CD

This feature allows you to assign a specific point on a disc to be called back later.

### To set a marker

- 1 During playback, press **[SEARCH MODE]** repeatedly until the "SEARCH MODE" appears.

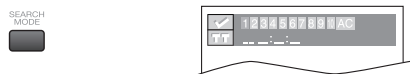

- 2 Use **[◀/▶]** to select a desired marker within 30 seconds.

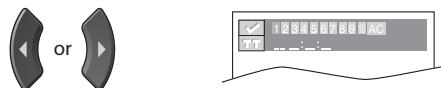

- 3 Press **[ENTER]** to set the marker.

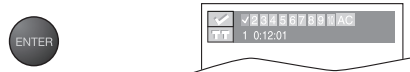

- 4 To exit the Marker setup display, press **[BACK/RETURN]**.



### To return to the marker later

- 1 In stop mode, press **[SEARCH MODE]** repeatedly until the "SEARCH MODE" appears.

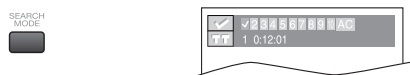

- 2 Use **[◀/▶]** to select a desired marker within 30 seconds.

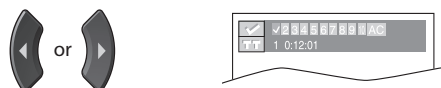

- 3 Press **[ENTER]** at the desired marker to restart playback from the specific point which you set.

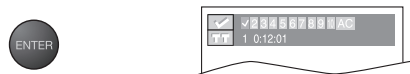

### NOTE:

- The Marker display will disappear in about 30 seconds when there is no input.
- You can mark up to 10 points.
- To clear a marker, select the marker to be cleared at step 2 in the section "To set a marker" or "To return to the marker later", and then press **[CLEAR]**.
- Ejecting the disc or turning off the power will erase all markers.
- Selecting "AC" at step 2 in the section "To set a marker" or "To return to the marker later" will also erase all markers.

Settings are only effective when the unit is in DVD mode and any discs should not be played back.

## ✓ DVD LANGUAGE SETTING

You can change the output language of the DVD player.

1 Press **[SETUP]** to display the setup screen.

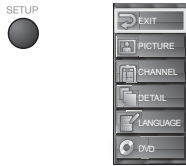

2 Use **[▲/▼]** to select "DVD", then press **[ENTER]**.



3 Use **[◀/▶]** to select "AUDIO", then press **[ENTER]**.

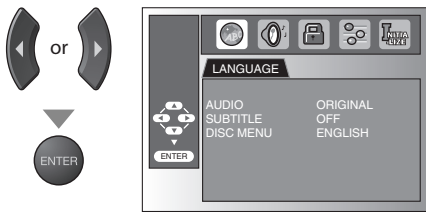

4 Use **[▲/▼]** to select the desired item, then press **[ENTER]**.



5 Use **[▲/▼]** to select the desired item, then press **[ENTER]**.

**[AUDIO] \*1, \*2**

(Default: ORIGINAL)

Sets the desired audio language.



**[SUBTITLE] \*1, \*2**

(Default: OFF)

Sets the desired subtitle language.

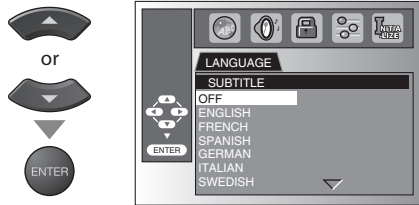

**[DISC MENU] \*1**

(Default: ENGLISH)

Sets the desired language in DVD menu.

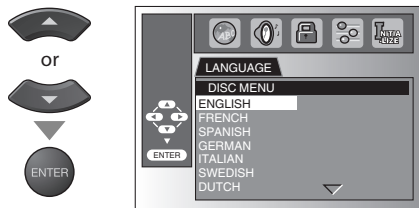

### NOTE:

\*1

- Language options are not available with some discs.
- If "OTHER" is selected in the AUDIO, SUBTITLE or DISC MENU screen, press four-digit number to enter the code for the desired language. (Refer to "LANGUAGE CODE LIST" on page 44.)
- Only the languages supported by the disc can be selected.

\*2

- Language setting for Audio and Subtitle are not available with some discs. Then press **[AUDIO]** and **[SUBTITLE]**. Details are on page 38.

6 To exit the setup, press **[SETUP]**.





## ✓ DVD AUDIO SETTING

Choose the appropriate audio settings for your equipment. It only affects during the playback of DVD discs.

1 Press **[SETUP]** to display the setup screen.

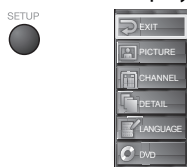

2 Use **[▲/▼]** to select "DVD", then press **[ENTER]**.



3 Use **[◀/▶]** to select "0", then press **[ENTER]**.

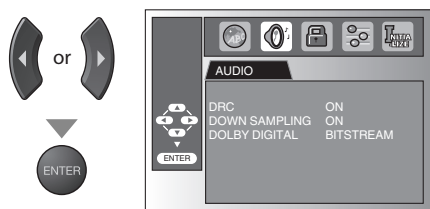

4 Use **[▲/▼]** to select the desired item, then press **[ENTER]**.

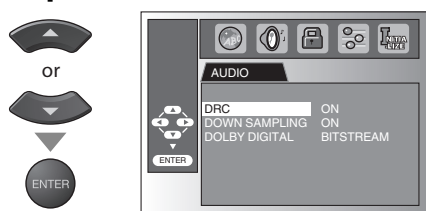

5 Use **[▲/▼]** to select the desired item, then press **[ENTER]**.

**[DRC]** (Default: ON)  
Sets the Dynamic Range Control.

This function is available only on the discs which are recorded in the Dolby Digital format.

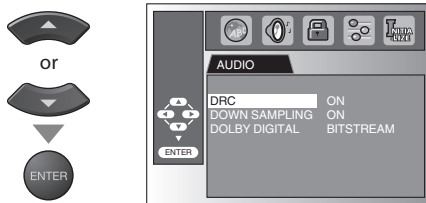

**ON** : Compress the range between soft and loud sounds.

**OFF** : No effects (original sound).

**[DOWN SAMPLING]** (Default: ON)

This function is available only on digital outputting of a disc recorded in 96kHz.

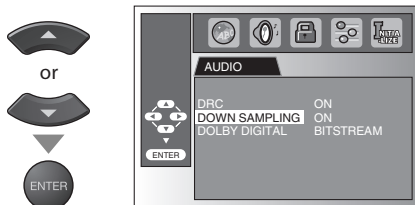

**ON** : When outputting in 48kHz.

**OFF** : When outputting the original sound.

### NOTE:

• When playing back a 96 kHz disc with the copyright protection or when Virtual Surround is set to 1 or 2, the sound will be down sampled at 48 kHz and output as digital audio even if the "DOWN SAMPLING" is set to "OFF".

**[DOLBY DIGITAL]** (Default: BITSTREAM)

Sets "BITSTREAM" when this unit is connected to a Dolby Digital decoder.

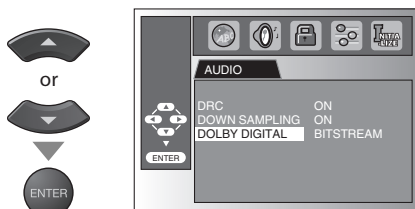

**BITSTREAM** : Outputs Dolby Digital signals.

**PCM** : Converts the Dolby Digital into PCM. (2 channel)

6 To exit the setup, press **[SETUP]**.



## ✓ PARENTAL SETTING

Parental setting prevents your children from viewing inappropriate materials. (password protected.) Playback will stop if the ratings exceed the levels you set.

**1** Press **[SETUP]** to display the setup screen.

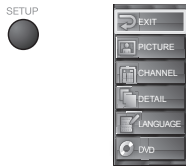

**2** Use **[▲/▼]** to select "DVD", then press **[ENTER]**.

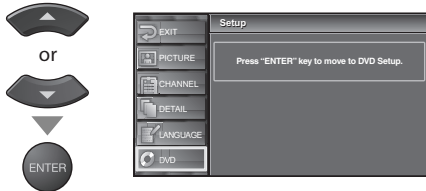

**3** Use **[◀/▶]** to select "PARENTAL", then press **[ENTER]**.

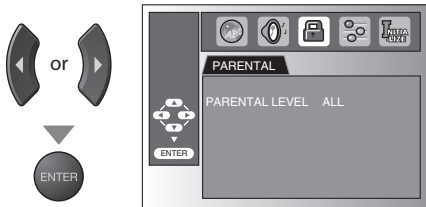

**4** Use **[the Number buttons]** to enter the 4-digit numbers for your password, then press **[ENTER]**.

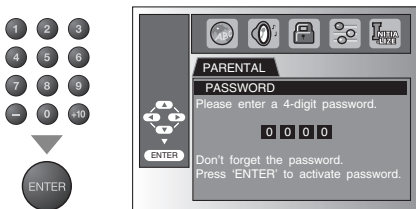

• If you have set password already, use **[the Number buttons]** to enter the current 4-digit password.

**5** Use **[▲/▼]** to select the "PARENTAL LEVEL", then press **[ENTER]**.

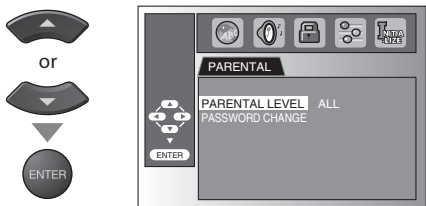

**6** Use **[▲/▼]** to select the desired item, then press **[ENTER]**.

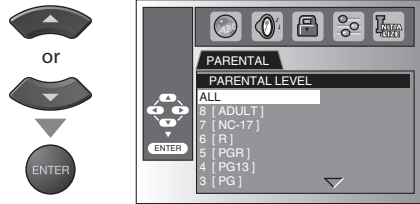

### CONTROL LEVELS

- ALL** : All parental locks are cancelled.
- LEVEL 8** : All ratings (adult/general/children) can be played back.
- LEVEL 7 to 2** : Only DVDs intended for general use and children can be played back.
- LEVEL 1** : Only DVDs intended for children can be played back.

**7** To exit the setup, press **[SETUP]**.



## To change the password

**5** Follow steps 1 to 4. Use **[▲/▼]** to select "PASSWORD CHANGE", then press **[ENTER]**.

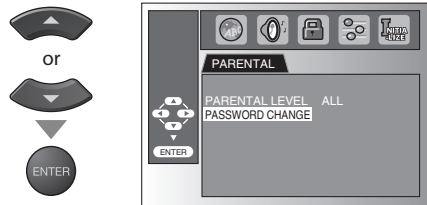

**6** Use **[the Number buttons]** to enter the new 4-digit password, then press **[ENTER]**.



### NOTE:

- DVD-Video discs may not respond to parental lock settings. Make sure this function works with your DVD-Video discs.
- Record the password in case you forget it.
- If you forget the password, press **[4], [7], [3], [7]** at step 6, then enter your new password. Password will be cleared and parental levels will be set to "ALL".

**7** To exit the setup, press **[SETUP]**.



## ☑ OTHERS

You can change the other functions.

1 Press **[SETUP]** to display the setup screen.

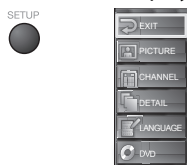

2 Use **[▲/▼]** to select "DVD", then press **[ENTER]**.



3 Use **[◀/▶]** to select "OTHERS", then press **[ENTER]**.

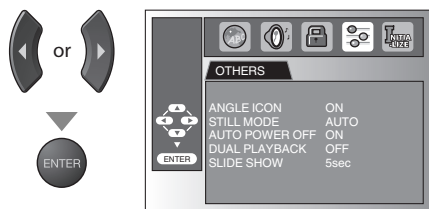

4 Use **[▲/▼]** to select the desired item, then press **[ENTER]**.



5 Use **[▲/▼]** to select the desired item, then press **[ENTER]**.

### [ANGLE ICON]

(Default: ON)

Set to "ON" to show the angle icon when multiple camera angles are available during DVD playback.

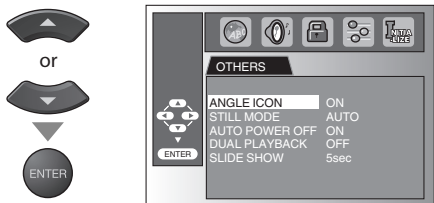

### [STILL MODE]

(Default: AUTO)

See note below.

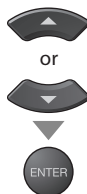

### NOTE:

#### STILL MODE:

- Select "AUTO" usually.
- If you select "FIELD", the picture in the still mode will be stabilized.
- If you select "FRAME", the picture in the still mode will be highly defined.

### [AUTO POWER OFF]

(Default: ON)

Set to "ON" to turn this unit off automatically after 20 minutes of no use.

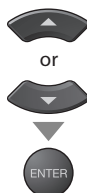

### [DUAL PLAYBACK]

(Default: OFF)

Set to "ON" to play back MP3 and JPEG files simultaneously.

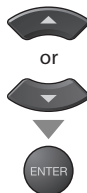

### [SLIDE SHOW]

(Default: 5sec)

Set to the length of displayed JPEG picture.

**5sec** : The picture changes every 5 seconds.

**10sec** : The picture changes every 10 seconds.

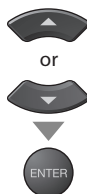

6 To exit the setup, press **[SETUP]**.



## ✓ RESET TO THE DEFAULT SETTING

You can reset all the settings except for the PARENTAL setting and on-screen menu language.

**1** Press **[SETUP]** to display the setup screen.

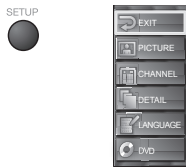

**2** Use **[▲/▼]** to select "DVD", then press **[ENTER]**.

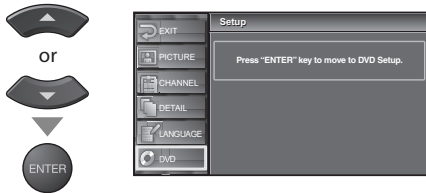

**3** Use **[◀/▶]** to select "INITIALIZE", then press **[ENTER]**.

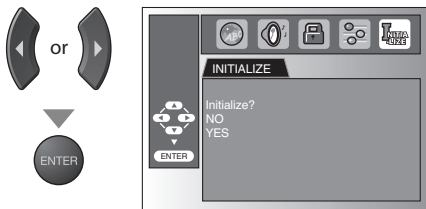

**4** Use **[▲/▼]** to select "YES", then press **[ENTER]**.

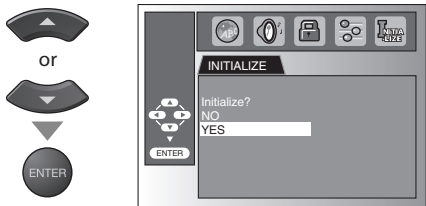

**NOTE:**

• When you want to cancel the initialization, select "NO" at step 4, then press **[SETUP]**.

**5** To exit the setup, press **[SETUP]**.



## ✓ LANGUAGE CODE LIST

Language	A-B	Code	Language	Code
Abkhazian		4748	Marathi	5964
Afar		4747	Moldavian	5961
Afrikaans		4752	Mongolian	5960
Albanian		6563	Nauru	6047
Amharic		4759	Nepali	6051
Arabic		4764	Norwegian [NOR]	6061
Armenian		5471		<b>O-R</b>
Assamese		4765	Occitan	6149
Aymara		4771	Oriya	6164
Azerbaijani		4772	Oromo(Afan)	6159
Bashkir		4847	Panjabi	6247
Basque		5167	Pashto; Pushto	6265
Bengali; Bangla		4860	Persian	5247
Bhutanian		5072	Polish [POL]	6258
Bihari		4854	Portuguese [POR]	6266
Bislama		4855	Quechua	6367
Breton		4864	Rhaeto-Romance	6459
Bulgarian		4853	Romanian [RUM]	6461
Burmese		5971	Russian [RUS]	6467
Byelorussian		4851		<b>S</b>
	<b>C-E</b>		Samoan	6559
Cambodian		5759	Sangho	6553
Catalan		4947	Sanskrit	6547
Chinese [CHI]		7254	Scots Gaelic	5350
Corsican		4961	Serbian	6564
Croatian		5464	Serbo-Croatian	6554
Czech [CZE]		4965	Sesotho	6566
Danish [DAN]		5047	Setswana	6660
Dutch [DUT]		6058	Shona	6560
English [ENG]		5160	Sindhi	6550
Esperanto		5161	Singhalese	6555
Estonian		5166	Siswat	6565
	<b>F-H</b>		Slovak	6557
Faroese		5261	Slovenian	6558
Fiji		5256	Somali	6561
Finnish [FIN]		5255	Spanish [SPA]	5165
French [FRE]		5264	Sundanese	6567
Frisian		5271	Swahili	6569
Galician		5358	Swedish [SWE]	6568
Georgian		5747		<b>T</b>
German [GER]		5051	Tagalog	6658
Greek [GRE]		5158	Tajik	6653
Greenlandic		5758	Tamil	6647
Guarani		5360	Tatar	6666
Gujarati		5367	Telugu	6651
Hausa		5447	Thai	6654
Hebrew		5569	Tibetan	4861
Hindi		5455	Tigrinya	6655
Hungarian [HUN]		5467	Tonga	6661
	<b>I-K</b>		Tsonga	6665
Icelandic [ICE]		5565	Turkish [TUR]	6664
Indonesian		5560	Turkmen	6657
Interlingua		5547	Twi	6669
Interlingue		5551		<b>U-Z</b>
Inupiak		5557	Ukrainian	6757
Irish [IRI]		5347	Urdu	6764
Italian [ITA]		5566	Uzbek	6772
Japanese [JPN]		5647	Vietnamese	6855
Javanese		5669	Volapuk	6861
Kannada		5760	Welsh	4971
Kashmiri		5765	Wolof	6961
Kazakh		5757	Xhosa	7054
Kinyarwanda		6469	Yiddish	5655
Kirghiz		5771	Yoruba	7161
Kirundi		6460	Zulu	7267
Korean [KOR]		5761		
Kurdish		5767		
	<b>L-N</b>			
Laothian		5861		
Latin		5847		
Latvian; Lettish		5868		
Lingala		5860		
Lithuanian		5866		
Macedonian		5957		
Malagasy		5953		
Malay		5965		
Malayalam		5958		
Maltese		5966		
Maori		5955		

**NOTE:**

• If you choose a language that has a 3-letter language code, the code will be displayed every time you change the AUDIO or SUBTITLE language setting above. If you choose any other language, '---' will be displayed instead. (3-letter language code is written in bracket.)

## ✓ TROUBLESHOOTING GUIDE

If the unit does not perform properly when operated as instructed in this Owner's Manual, check the following chart once before calling for service.

Symptom	Remedy
No power	<ul style="list-style-type: none"> <li>• Be sure the power cord is plugged in.</li> <li>• If a power failure occurs, unplug the power cord for 30 minutes to allow the unit to reset itself.</li> </ul>
No picture or sound	<ul style="list-style-type: none"> <li>• Check if the power is on.</li> <li>• Check the outlet connection.</li> <li>• Check the antenna or cable connection to the main unit.</li> <li>• When the outside antenna is used, check the wire condition and connection.</li> <li>• View other TV channels. The problem might be limited to the broadcasting station.</li> <li>• Turn off the power and wait for about 1 minute, then turn it on again.</li> </ul>
No color	<ul style="list-style-type: none"> <li>• Check the antenna or cable connection to the main unit.</li> <li>• When the outside antenna is used, check the wire condition and connection.</li> <li>• View other TV channels. The problem might be limited to the broadcasting station.</li> <li>• Adjust the Color in the setup screen.</li> </ul>
Sound OK, picture poor	<ul style="list-style-type: none"> <li>• Check the antenna or cable connection to the main unit.</li> <li>• When the outside antenna is used, check the wire condition and connection.</li> <li>• Electrical interference from nearby appliances may affect picture quality.</li> <li>• Adjust Contrast and Brightness in the setup screen.</li> <li>• View other TV channels. The problem might be limited to the broadcasting station.</li> </ul>
Picture distorted	<ul style="list-style-type: none"> <li>• When the outside antenna is used, check the wire condition and connection.</li> <li>• View other TV channels. The problem might be limited to the broadcasting station.</li> </ul>
Weak picture	<ul style="list-style-type: none"> <li>• Check the antenna or cable connection to the main unit.</li> <li>• When the outside antenna is used, check the wire condition and connection.</li> <li>• Adjust Contrast and Brightness in the setup screen.</li> <li>• View other TV channels. The problem might be limited to the broadcasting station.</li> </ul>
Lines or streaks in picture	<ul style="list-style-type: none"> <li>• When the outside antenna is used, check the wire condition and connection.</li> <li>• Electrical interference from nearby appliances may affect picture quality.</li> <li>• View other TV channels. The problem might be limited to the broadcasting station.</li> </ul>
Picture blurred	<ul style="list-style-type: none"> <li>• When the outside antenna is used, check the wire condition and connection.</li> <li>• View other TV channels. The problem might be limited to the broadcasting station.</li> </ul>
Ghosts in picture	<ul style="list-style-type: none"> <li>• Check the antenna or cable connection to the main unit.</li> <li>• When the outside antenna is used, check the wire condition and connection.</li> <li>• Electrical interference from nearby appliances may affect picture quality.</li> <li>• View other TV channels. The problem might be limited to the broadcasting station.</li> </ul>
Bars on screen	<ul style="list-style-type: none"> <li>• When the outside antenna is used, check the wire condition and connection.</li> <li>• Electrical interference from nearby appliances may affect picture quality.</li> </ul>
Picture rolls vertically	<ul style="list-style-type: none"> <li>• When the outside antenna is used, check the wire condition and connection.</li> <li>• Electrical interference from nearby appliances may affect picture quality.</li> <li>• View other TV channels. The problem might be limited to the broadcasting station.</li> </ul>
Different color marks on screen	<ul style="list-style-type: none"> <li>• Move your TV away from nearby electric appliances. Turn off the power and wait 30 minutes before turning it back on.</li> <li>• View other TV channels. The problem might be limited to the broadcasting station.</li> </ul>
Poor reception on some channels	<ul style="list-style-type: none"> <li>• Check the antenna or cable connection to the main unit.</li> <li>• When the outside antenna is used, check the wire condition and connection.</li> <li>• Electrical interference from nearby appliances may affect picture quality.</li> <li>• View other TV channels. The problem might be limited to the broadcasting station.</li> </ul>
Picture OK, sound poor	<ul style="list-style-type: none"> <li>• Electrical interference from nearby appliances may affect picture quality.</li> <li>• View other TV channels. The problem might be limited to the broadcasting station.</li> </ul>
No reception of digital signals	<ul style="list-style-type: none"> <li>• Make sure Autoscanner has been completed (Refer to "AUTOSCAN" on page 14). Autoscanner must be completed when you set up your TV for the first time or move it to a location where previously unavailable channels are broadcast.</li> <li>• The selected channel may not be broadcasting.</li> <li>• When Autoscanner is interrupted and not completed, some channels will not be received. Make sure to complete Autoscanner in the setup screen.</li> </ul>

Symptom	Remedy
The entered channel number changes automatically	<ul style="list-style-type: none"> <li>• Many digital channels have alternate channel numbers. TV changes the numbers automatically to the ones signifying the broadcasting stations. These are the numbers used for analog broadcasts.</li> </ul>
Remote control does not work	<ul style="list-style-type: none"> <li>• Check the antenna or cable connection to the main unit.</li> <li>• Check the batteries of the remote control.</li> <li>• Check if there is an obstacle between the sensor and the remote control.</li> <li>• Test the signal output. If OK, then possible remote sensor trouble. (Refer to "IR SIGNAL CHECK" on page 47.)</li> <li>• Aim the remote control directly at the sensor on the front of the unit.</li> <li>• Reduce the distance to the unit.</li> <li>• Re-insert the batteries with their polarities (+/- signs) as indicated.</li> </ul>
<b>Problems with Closed Caption Feature</b>	
<b>T</b> Misspelled captions are displayed.	<ul style="list-style-type: none"> <li>• Closed captioning production companies may broadcast programs without correcting the misspelling in a live broadcast.</li> </ul>
<b>V</b> Captions are not entirely displayed, or captions are delayed behind the dialogue.	<ul style="list-style-type: none"> <li>• Captions that are delayed a few seconds behind the actual dialogue are common for live broadcasts. Most captioning production companies can display a dialogue to a maximum of 220 words per minute. If a dialogue exceeds that rate, selective editing is used to insure that the captions remain up-to-date with the current TV screen dialogue.</li> </ul>
Captions are displayed as a white box. No caption is displayed in the Closed Caption-supported program.	<ul style="list-style-type: none"> <li>• Interference from buildings or weather conditions may cause captioning to be incomplete.</li> <li>• Broadcasting station may shorten the program to insert advertisement. The closed caption decoder cannot read the information of the shortened program.</li> </ul>
No caption is displayed when playing the videotape containing captions.	<ul style="list-style-type: none"> <li>• The videotape may be illegally copied, or the caption signal might not have been read during copying.</li> </ul>
Black box is displayed in the screen.	<ul style="list-style-type: none"> <li>• "Text" mode is selected for caption. Select "CC1", "CC2", "CC3", "CC4" or "Off".</li> </ul>
<b>D</b> Completely distorted picture or black/white picture with DVD	<ul style="list-style-type: none"> <li>• Make sure the disc is compatible with the unit.</li> </ul>
Picture freezes momentarily during playback.	<ul style="list-style-type: none"> <li>• Check the disc for finger prints/scratches and clean with a soft cloth wiping from center to edge.</li> </ul>
Disc cannot be played.	<ul style="list-style-type: none"> <li>• Clean the disc.</li> <li>• Ensure the disc is correctly inserted.</li> <li>• Check if the disc is defective by trying another disc.</li> <li>• Cancel the parental lock or change the control level.</li> <li>• Insert a correct disc that plays on this unit.</li> <li>• Handle a disc with special care so that it does not have fingerprints, scratches, or dusts on its surface.</li> </ul>
<b>V</b> Buttons do not work or the unit stops responding.	<ul style="list-style-type: none"> <li>• To completely reset the unit, unplug the power cord from the power outlet for 5-10 seconds.</li> </ul>
The unit does not respond to some operating commands during playback.	<ul style="list-style-type: none"> <li>• Operations may not be permitted by the disc. Refer to the instructions of the disc.</li> </ul>
Angle does not switch.	<ul style="list-style-type: none"> <li>• The angle cannot be switched for DVDs which do not contain multiple angles. In some cases multiple angles are only recorded for specific scenes.</li> </ul>
Playback does not start when the title is selected.	<ul style="list-style-type: none"> <li>• Check the "PARENTAL" setting.</li> </ul>
The password for rating level has been forgotten.	<ul style="list-style-type: none"> <li>• Enter the default password "4737", then your forgotten password will be cleared.</li> </ul>

### NOTE:

- The LCD panel is manufactured to provide many years of useful life. Occasionally a few non active pixels may appear as a fixed point of blue, green or red. This is not to be considered a defect in the LCD screen.
- Some functions are not available in specific modes, but this is not a malfunction. Read the description in this Owner's Manual for more details on correct operations.
- Playback from a desired track and random playback are not available during program playback.
- Some functions are prohibited on some discs.

## ✓ GLOSSARY

### ATSC

Acronym that stands for Advanced Television Systems Committee and the name of the digital broadcasting standards.

### Aspect ratio

The width of a TV screen relative to its height. Conventional TVs are 4:3 (in other words, the screen is almost square); widescreen models are 16:9 (the screen is almost twice as wide as its height).

### Component video

This is a video signal format that conveys each of three principal colors of light (red, blue and green) through different signal lines. This allows the viewers to experience picture colors as original as it is. There are several signal formats, including Y / Pb / Pr and Y / Cb / Cr.

### Dolby Digital

The system developed by Dolby Laboratories to compress digital sound. It offers stereo sound (2ch) or multi-channel audio (up to 5.1ch).

### HDMI

#### (High-Definition Multimedia Interface)

Interface that supports all uncompressed, digital audio/video formats including set-top box, DVD player or digital television, over a single cable.

### High Definition TV (HDTV)

Ultimate digital format that produces high resolution and high picture quality.

### LPCM

#### (Linear Pulse Code Modulation)

LPCM is a format that can have up to 8 channels of audio. It is mainly used in music production. The format samples and captures analog signals and transforms them into digital signals without compressing the sound data.

### NTSC

Acronym that stands for National Television Systems Committee and the name of the current analog broadcasting standards.

### Password

A stored 4-digit number that allows access to parental control features.

### SAP

#### (Secondary Audio Program)

Second-audio channel delivered separately from main-audio channel. This audio channel is used as an alternate in bilingual broadcasting.

### Standard Definition TV (SDTV)

Standard digital format that is similar to the NTSC picture quality.

### S-Video

Offers higher quality images by delivering each signal, color (c) and luminance (y) independently of each other through separate cables.

## ✓ CABLE CHANNEL DESIGNATIONS

If you subscribe to cable TV, the channels are displayed as 1-125. Cable companies often designate channels with letters or letter-number combinations. Please check with your local cable company. The following is a chart of common cable channel designations.

CATV channel	5A	2	3	4	5	6	7	8	9	10	11	12	13	A	B	C	D	E	F	G	H
TV Display	1	2	3	4	5	6	7	8	9	10	11	12	13	14	15	16	17	18	19	20	21
CATV channel	I	J	K	L	M	N	O	P	Q	R	S	T	U	V	W	W+1	W+2	W+3	W+4	W+5	W+6
TV Display	22	23	24	25	26	27	28	29	30	31	32	33	34	35	36	37	39	40	41	42	
CATV channel	W+7	W+8	W+9	W+10	W+11	W+12	W+13	W+14	W+15	W+16	W+17	W+18	W+19	W+20	W+21	W+22	W+23	W+24	W+25	W+26	W+27
TV Display	43	44	45	46	47	48	49	50	51	52	53	54	55	56	57	58	59	60	61	62	63
CATV channel	W+28	W+29	W+30	W+31	W+32	W+33	W+34	W+35	W+36	W+37	W+38	W+39	W+40	W+41	W+42	W+43	W+44	W+45	W+46	W+47	W+48
TV Display	64	65	66	67	68	69	70	71	72	73	74	75	76	77	78	79	80	81	82	83	84
CATV channel	W+49	W+50	W+51	W+52	W+53	W+54	W+55	W+56	W+57	W+58	A-5	A-4	A-3	A-2	A-1	W+59	W+60	W+61	W+62	W+63	W+64
TV Display	85	86	87	88	89	90	91	92	93	94	95	96	97	98	99	100	101	102	103	104	105
CATV channel	W+65	W+66	W+67	W+68	W+69	W+70	W+71	W+72	W+73	W+74	W+75	W+76	W+77	W+78	W+79	W+80	W+81	W+82	W+83	W+84	
TV Display	106	107	108	109	110	111	112	113	114	115	116	117	118	119	120	121	122	123	124	125	

## ✓ MAINTENANCE

### CABINET CLEANING

- Wipe the front panel and other exterior surfaces of the TV with a soft cloth immersed in lukewarm water and wrung dry.
- Never use a solvent or alcohol. Do not spray insecticide liquid near the TV. Such chemicals may cause damage and discoloration to the exposed surfaces.

### LCD CLEANING

- Wipe the LCD of the TV with a soft cloth. Before cleaning the LCD, disconnect the power cord.

### SERVICING

Should your unit become inoperative, do not try to correct the problem yourself. There are no user serviceable parts inside. Turn off the TV, unplug the power cord and call our toll free customer support line found on the cover of this manual to locate an authorized service center.

### IR SIGNAL CHECK

If the remote control is not working properly, you can use an AM radio or digital camera (including a cellular phone with built-in camera) to see if it is sending out an infrared signal.

#### • With an AM radio:

Tune the AM radio station to a non-broadcasting frequency. Point the remote control towards it, push any button and listen. If the sound from the radio flutters, it is receiving the remote control's infrared signal.

#### • With a digital camera

(including built-in cell phone cameras)



Point a digital camera towards the remote control. Push any button on the remote control and look through the digital camera. If the infrared light appears through the camera, the remote control is working.

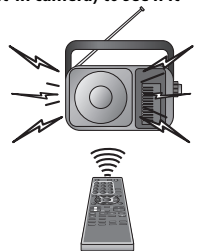

**✓ GENERAL SPECIFICATIONS**

**TV**

**Television System:** ATSC / NTSC-M TV Standard

**Closed Caption System:**

\$15.122/FCC (Digital CC)  
\$15.119/FCC (Analog CC)

**Channel Coverage (ATSC/NTSC):**

**VHF:** 2 ~ 13  
**UHF:** 14 ~ 69  
**CATV:** 2 ~ 13, A ~ W, W+1 ~ W+94,  
A-5 ~ A-1, 5A

**Tuning System:** Channel frequency synthesized tuning system

**Channel Access:** Direct access keyboard, Programmable scan, and Up/down

**Terminals:**

- Antenna Input:** VHF/UHF/CATV  
75 ohm unbalanced (F-type)
- S-Video Input:** Mini DIN 4-pin jack x 2
- Video Input:** RCA jack x 2
- Audio Input:** RCA jack (L/R) x 4
- Component Video/Audio Input:**  
One pin jack (Y) / 1Vpp x 2  
Two pin jacks (Pb/Pr) / 700mVpp x 4  
RCA jack (L/R) x 4
- HDMI/Audio Input:** HDMI jack  
RCA jack (L/R) x 2
- Coaxial Digital Audio Output:**  
One pin jack, 500mVpp
- Analog Audio Output:**  
RCA jack (L/R) x 2

**Stereo Sound System Speaker**

**DVD**

**Discs (Playback compatibility):**

DVD Video, DVD-RW/-R,  
DVD+RW/+R, Audio CD, CD-RW/-R

**Frequency response:**

**DVD (linear sound):** 20 Hz to 20 kHz (sample rate: 48 kHz)  
20 Hz to 44 kHz (sample rate: 96 kHz)  
**CD:** 20 Hz to 20 kHz

**Signal-to-noise ratio (S/N ratio):**

**CD:** 90 dB (JEITA)

**Dynamic range:**

**DVD (linear sound):** 86 dB  
**CD:** 86 dB (JEITA)

**Total distortion factor:**

**DVD:** 1 KHz 0.008% (JEITA)  
**CD:** 1 KHz 0.008% (JEITA)

**Wow and flutter:** Below the measurement limitation (+/-0.001% W PEAK) (JEITA)

**✓ ELECTRICAL SPECIFICATION**

**Sound Output:** 5W, 8 ohm x 2

**✓ OTHER SPECIFICATIONS**

**Remote Control:** Digital encoded infrared light system

**Operating Temperature:** 41°F (5°C) to 104°F (40°C)

**Power Requirements:** 120 V AC +/- 10%, 60 Hz +/- 0.5%

**Power Consumption(Maximum):** 150W (standby: 1.0 W)

**LCD:** 26" wide XGA panel (1,366 x 768 pixels)

**Dimensions:** <Without stand>  
H : 20-5/8" (523.5mm)  
W : 27-15/16" (710mm)  
D : 4-1/2" (114.5mm)  
<With stand>  
H : 22-5/8" (574mm)  
W : 27-15/16" (710mm)  
D : 10-13/16" (275mm)

**Weight:** 30.8 lbs. (14kg)

- Designs and specifications are subject to change without notice and without our legal obligation.
- If there is a discrepancy between languages, the default language will be English.



✓ **FUNCIONES DEL MANDO A DISTANCIA**

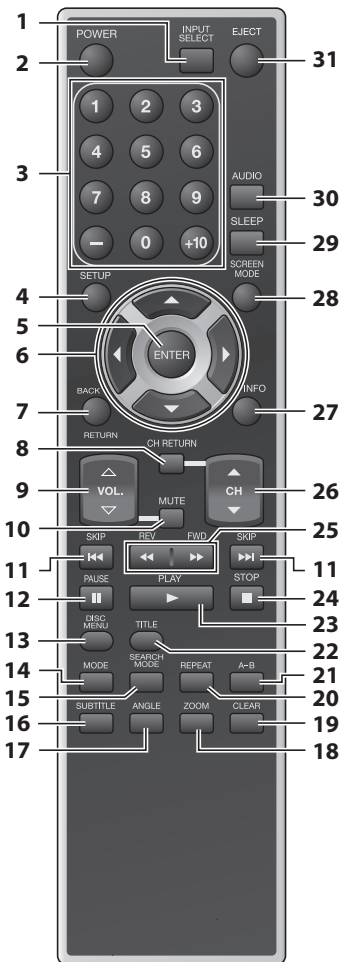

1. **Botón INPUT SELECT**  
Presiónelo para acceder a aparatos externos conectados, tales como un grabador de DVD o una VCR.
2. **Botón POWER** (pág.55)  
Para encender y apagar el TV/DVD.
3. **Botones de Número de canal** (pág.57)  
Para seleccionar canales.  
• Para introducir número de título, capítulo o pista.
4. **Botón SETUP** (pág.56)  
Para mostrar el menú en pantalla.
5. **Botón ENTER** (pág.55)  
Para decidir los comandos de ajuste cuando aparece el menú.
6. **Botones ◀/▶/▲/▼** (pág.55)  
Para desplazarse por los elementos a izquierda/derecha/arriba/abajo.
7. **Botón BACK//RETURN** (pág.59)  
Para volver a la operación anterior en el menú.
8. **Botón CH RETURN**  
Para volver al canal que se estaba viendo antes.
9. **Botón VOL.** ▲/▼ (pág.55)  
Para ajustar el volumen.
10. **Botón MUTE**  
Para desactivar y activar el sonido.
11. **Botones SKIP ◀◀/▶▶**  
Para saltar adelante o atrás en capítulos, títulos (DVD), pistas (CD, MP3, JPEG) o carpetas (MP3, JPEG).
12. **Botón PAUSE** (pág.58)  
Para hacer pausa en la reproducción del disco.
13. **Botón DISC MENU** (pág.58 /pág.59)  
Para activar el menú en un disco (DVD) o LISTA DE ARCHIVOS (MP3, JPEG).
14. **Botón MODE**  
• Para activar "LISTA DE CARPETA" de un disco cuando "REPROD. DOBLE" está en "ENC." (MP3, JPEG).  
• Para establecer el orden de reproducción o reproducir aleatoriamente (CD, MP3, JPEG).  
• Para establecer el nivel de negro (DVD) y activar o desactivar el sonido envolvente virtual (DVD, CD, MP3).
15. **Botón SEARCH MODE**  
• Para buscar capítulo, título (DVD), tiempo (DVD, CD) o pista (CD, MP3, JPEG).
16. **Botón SUBTITLE**  
Para seleccionar los subtítulos en un disco (DVD).
17. **Botón ANGLE**  
Para cambiar el ángulo de cámara para ver la secuencia reproducida desde un ángulo diferente (DVD).
18. **Botón ZOOM**  
Para magnificar una parte de la imagen (2X y 4X: DVD, 2X: JPEG).
19. **Botón CLEAR**  
• Para borrar los números introducidos incorrectamente.  
• Para cancelar el punto A para repetición A-B (DVD, CD).  
• Para eliminar el número de la pista en la introducción de programas (CD, MP3, JPEG).
20. **Botón REPEAT**  
Para reproducir un capítulo o título (DVD), pista, disco (CD, MP3, JPEG) o grupo (MP3, JPEG) repetidamente.
21. **Botón A-B**  
Para repetir entre el punto A y B seleccionado (DVD, CD).
22. **Botón TITLE** (pág.58)  
Para activar la lista de títulos (DVD).
23. **Botón PLAY** ▶ (pág.58)  
Para comenzar la reproducción del disco.
24. **Botón STOP** ■ (pág.58)  
Para interrumpir la reproducción del disco.
25. **Botones REV ◀◀ / FWD ▶▶** (pág.59)  
Para comenzar la reproducción de avance lento o retroceso lento durante el modo pausa (DVD) y la búsqueda adelante y atrás en un disco.
26. **Botones CH ▲/▼** (pág.56)  
Para seleccionar los canales y el modo de entrada externo.
27. **Botón INFO**  
• **Modo analógico (TV)**  
Para mostrar el número de canal, tipo de señal y ajuste de TV.  
• **Modo digital (DTV)**  
Para mostrar la información de canal, tipo de señal y ajuste de TV.  
• **Modo externo**  
Para mostrar modo externo, tipo de señal y ajuste de TV.  
• **Modo DVD**  
Para visualizar el estado actual (DVD, CD, MP3, JPEG).
28. **Botón SCREEN MODE**  
Selecciona las relaciones de aspecto disponibles para la pantalla.
29. **Botón SLEEP**  
Para apagar automáticamente el aparato a la hora prefijada.
30. **Botón AUDIO**  
• **Modo analógico (TV)**  
Para seleccionar el modo audio.  
• **Modo digital (DTV)**  
Para seleccionar el idioma de audio.  
• **Modo DVD**  
Para seleccionar el idioma de audio (DVD) o el modo de sonido (CD).
31. **Botón EJECT** (pág.58)  
Para expulsar el disco.

**NOTA:**

- Con los botones [VOL. ▲/▼] o [MUTE], solamente puede ajustar el volumen de la unidad principal. No puede ajustar el volumen de los dispositivos externos con estos botones.
- A menos que se indique lo contrario, todas las operaciones descritas se basan en la utilización de un mando a distancia.

✓ **INSTALACIÓN DE LAS PILAS**

Coloque las dos pilas AA (incluidas) haciendo coincidir la polaridad (+/--) indicada dentro del compartimento del mando a distancia.

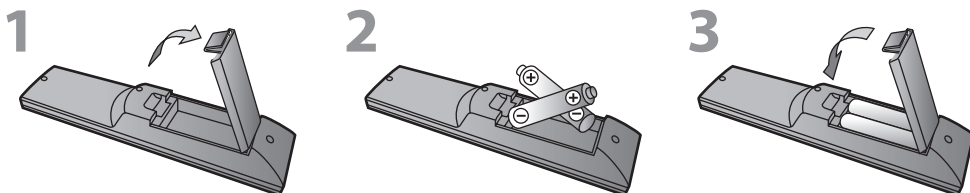

**PRECAUCIONES RELACIONADAS CON LAS PILAS:**

- Asegúrese de respetar la polaridad correcta como se indica en el compartimento de las pilas. Si invierte las pilas puede causar daño al dispositivo.
- No combine tipos diferentes de pilas. (por ej., Alcalinas y Carbón-Zinc) o pilas usadas con pilas nuevas.
- Si el dispositivo no se usará por un periodo largo, se deben retirar las pilas para evitar daños o lesiones causadas por el posible derrame del ácido en su interior.
- No intente recargar pilas que no están diseñadas para ese fin, ya que pueden sobrecalentarse y agrietarse.

## ✓ PANEL DE CONTROL

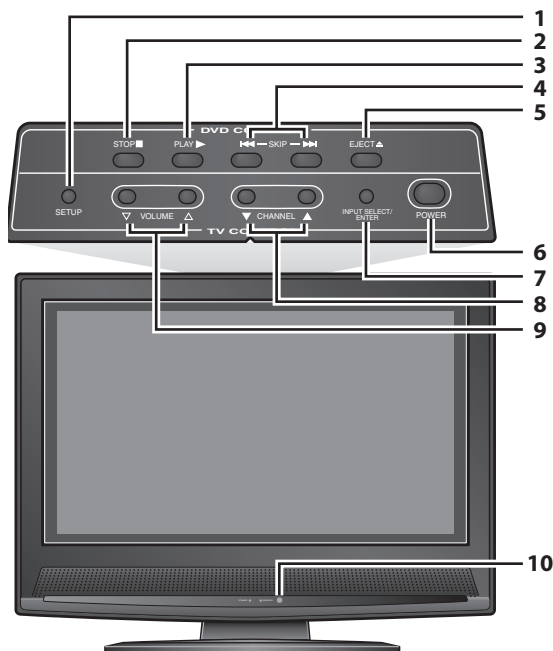

- Botón SETUP** (pág.56)  
Para ver el menú en pantalla.
- Botón STOP** ■ (pág.58)  
Para interrumpir la reproducción del disco.
- Botón PLAY** ► (pág.58)  
Para comenzar la reproducción del disco.
- Botones SKIP** ◀◀ / ▶▶  
Para saltar capítulos, títulos (DVD), o pistas (CD, MP3 o JPEG).
- Botón EJECT** ▲ (pág.58)  
Para expulsar el disco.
- Botón POWER** (pág.55)  
Para encender y apagar el TV/DVD.
- Botón INPUT SELECT / ENTER** (pág.55)
  - Para acceder a aparatos externos conectados, tales como un grabador de DVD o una VCR.
  - Para decidir el comando de ajuste cuando aparezca el menú.
- Botones CHANNEL** ▲/▼  
Para seleccionar canales y desplazarse arriba/abajo por los elementos del menú.
- Botones VOLUME** ▲/▼  
Para ajustar el volumen y desplazarse a derecha(▲)/izquierda(▼) por los elementos del menú.
- Ventana del sensor de infrarrojos**  
Para recibir los rayos infrarrojos transmitidos desde el mando a distancia.

### NOTA:

• Con los botones [VOLUME ▲/▼], solamente puede ajustar el volumen de la unidad principal. No puede ajustar el volumen de los dispositivos externos con estos botones.

## ✓ PANEL TRASERO

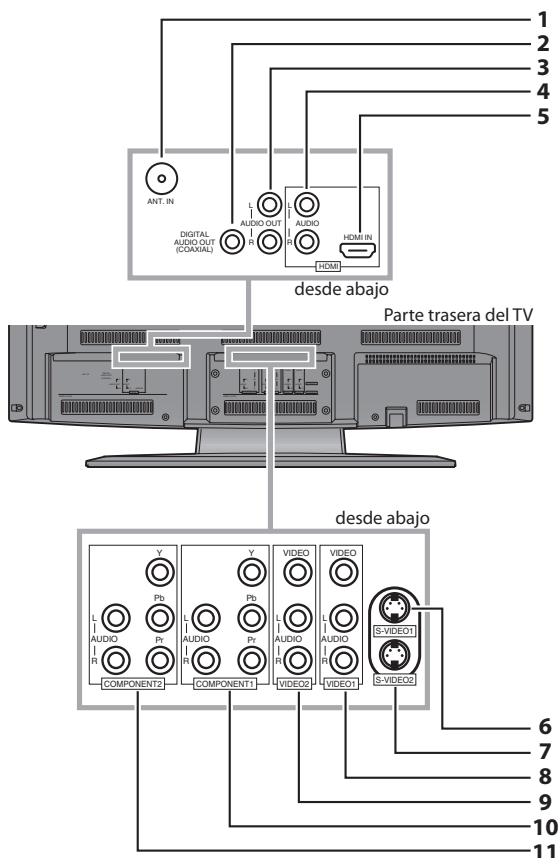

- Toma ANT. IN** (pág.51)  
Conexión de cable coaxial a su antena o su caja de cable.
- Toma DIGITAL AUDIO OUT (COAXIAL)** (pág.54)  
Conexión de cable coaxial de audio digital a un decodificador o receptor de audio. Conecte el cable a la toma de entrada audio digital del aparato externo.
- Tomas AUDIO OUT** (pág.54)  
Conexión de cable de audio a dispositivos de audio externos. Utilice las tomas de entrada audio del aparato externo.
- Tomas de entrada AUDIO (para conexión DVI)** (pág.52)  
Conexión de cable de audio a aparatos de audio/vídeo externos con toma DVI. Utilice las tomas de entrada audio del dispositivo externo al usar un cable de conversión HDMI-DVI.
- Toma HDMI IN** (pág.52)  
Conexión de cable HDMI a aparatos de vídeo externos (es decir, grabador de DVD).
- Toma de entrada S-VIDEO1** (pág.53)  
Conexión de cable S-Video y de cable de audio (VIDEO1) a dispositivos de vídeo externos.
- Toma de entrada S-VIDEO2** (pág.53)  
Conexión de cable S-Video y de cable de audio (VIDEO2) a dispositivos de vídeo externos.
- Tomas de entrada VIDEO1 y AUDIO** (pág.54)  
Conexión de cable de vídeo y de audio a dispositivos externos.
- Tomas de entrada VIDEO2 y AUDIO** (pág.54)  
Conexión de cable de vídeo y de audio a dispositivos externos.
- Tomas de entrada COMPONENT1 y AUDIO** (pág.53)  
Conexión de cable de componentes a dispositivos de audio/vídeo externos. Utilice las tomas de salida de componentes y de audio del dispositivo externo.
- Tomas de entrada COMPONENT2 y AUDIO** (pág.53)  
Conexión de cable de componentes a dispositivos de audio/vídeo externos. Utilice las tomas de salida de componentes y de audio del dispositivo externo.

## ✓ CONEXIÓN

Esta sección describe cómo conectar el televisor a una antena, caja de cable, etc.

### ASEGÚRESE DE TENER UNA ANTENA.

Como el DTV sólo existe en ondas aéreas, necesita una antena para recibir señal digital.

#### NOTA:

• Asegúrese de que la antena o la otra fuente esté bien conectada antes de enchufar el cable de alimentación.

#### [CONEXIÓN DE CABLE DE ANTENA]

1) Para conectar el televisor a una antena

Conecte el cable coaxial de televisión de su casa a la toma ANT.IN del TV.

2) Cuando se conecta el TV a la empresa del TV cable (sin caja)

Conecte el cable coaxial de televisión de su casa a la toma ANT.IN del TV.

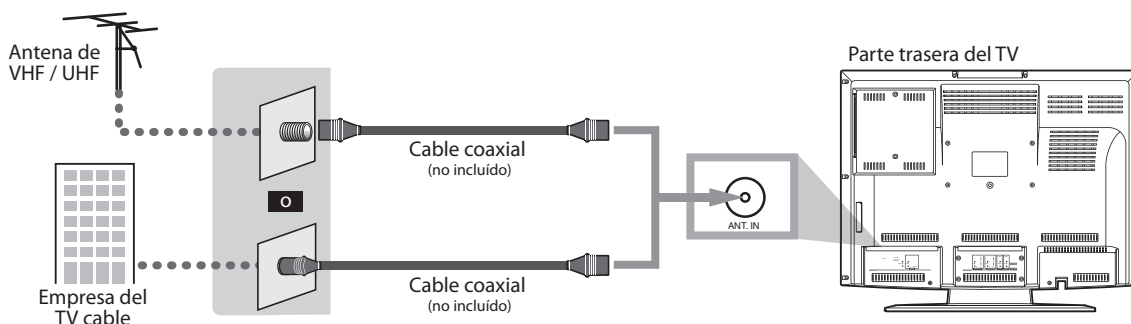

\*Una vez hechas las conexiones, encienda el TV y empiece con los ajustes iniciales.

La exploración de canales es necesaria para que el TV memorice todos los canales disponibles en su zona. (Consulte el "PREAJUSTES INICIAL" en la página 55.)

#### NOTA:

- Para su seguridad y con el fin de evitar daños al equipo, por favor desenchufe el cable coaxial de la toma ANT.IN antes de trasladar la unidad.
- Si utiliza una antena para recibir TV analógica, la misma antena permitirá recibir la DTV. Las antenas exteriores o en el techo serán más efectivas que la versiones encima del aparato de TV.
- Para cambiar fácilmente entre los cables de antena y de cable puede comprar un selector de antena (no incluido).
- Si desea conectar el sistema de cable directamente, póngase en contacto con el instalador del sistema CATV.

#### [CONEXIÓN CON CAJA DE CONVERTIDOR/CAJA DE SATÉLITE]

1) Conecte el cable coaxial de la toma de su casa al conector de entrada de la caja de CABLE/SATÉLITE.

2) Utilice otro cable coaxial para conectar la toma ANT.IN de su televisor a la toma de salida de la caja de CABLE/SATÉLITE.

#### EX.

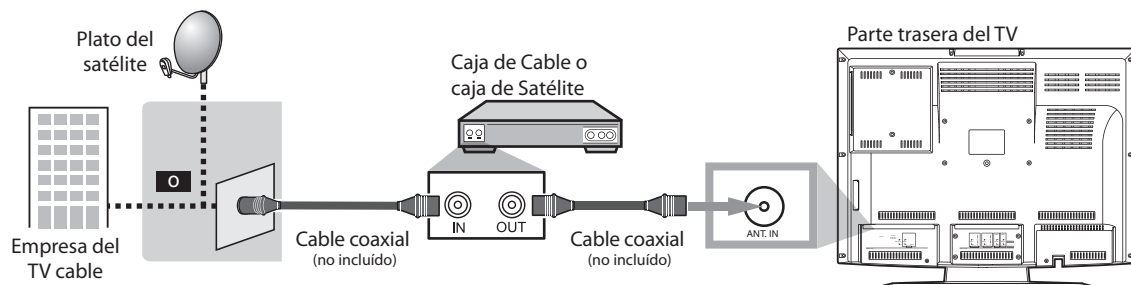

\*Los cables necesarios en 2) y los métodos de conexión varían según la caja de CABLE/SATÉLITE. Para más información, póngase en contacto con su proveedor de cable/satélite.

## ✓ CONEXIÓN DE OTROS DISPOSITIVOS

### [HDMI]

1) El sistema HDMI (Interfaz Multimedia de Alta Definición) incorpora la tecnología más avanzada para asegurar que la señal mantiene el mayor grado de intensidad posible desde la fuente al televisor. Tanto el vídeo como el audio viajan a través de un único cable.

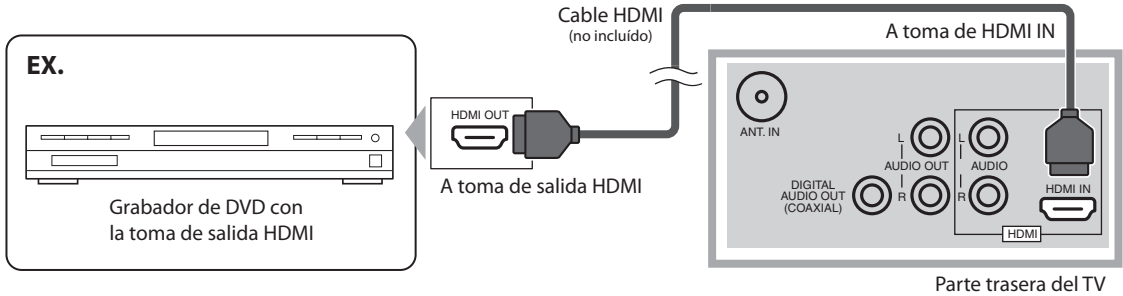

### NOTA:

- Este TV acepta señales de vídeo de 480i / 480p / 720p / 1080i, y señales de audio de 32 kHz / 44,1 kHz / 48 kHz.
- Este TV acepta solamente señal de audio de dos canales (LPCM).
- Necesita seleccionar "PCM" para la salida de audio digital del dispositivo que conecte o para el ajuste de audio HDMI. El audio a veces no emite sonidos si selecciona "Bitstream", etc.
- Este TV solamente acepta señales correspondientes a EIA861.

2) Si su aparato de vídeo tiene una toma de salida DVI, conecte el cable de conversión HDMI (no incluido) desde la toma de salida DVI.

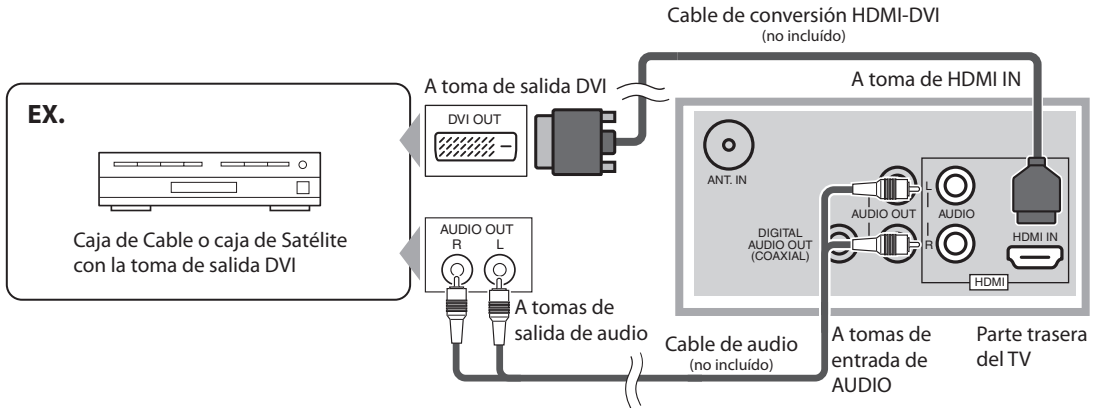

### NOTA:

- Este TV acepta señales de vídeo de 480i / 480p / 720p / 1080i.
- Un cable de conversión HDMI requiere asimismo una conexión aparte de cable de audio.
- Las señales de audio se convierten de señal digital a señal analógica si se establece una conexión como se indica en el párrafo 2) de arriba.
- DVI no muestra imagen si la señal 480i no acepta EIA/CEA-861/861B.

**HDMI**  
HIGH-DEFINITION MULTIMEDIA INTERFACE

“HDMI el logotipo HDMI y High-Definition Multimedia Interface (Interface de Multimedia de Alta Definición) son marcas comerciales o marcas registradas de HDMI Licensing LLC.”

### [CONEXIÓN DE CABLE DE COMPONENTES]

Ofrece una mejor calidad de imagen para dispositivos de vídeo conectados a su TV.

Utilice un cable conector de vídeo componente (no incluido) para conectar su TV a dispositivos externos de vídeo equipados con tomas de vídeo componentes.

Si conecta las tomas de salida componente a la toma de entrada COMPONENT1, conecte un cable de audio a las tomas AUDIO L/R (izquierda/derecha) de COMPONENT1.

Si conecta las tomas de salida componente a la toma de entrada COMPONENT2, conecte un cable de audio a las tomas AUDIO L/R (izquierda/derecha) de COMPONENT2.

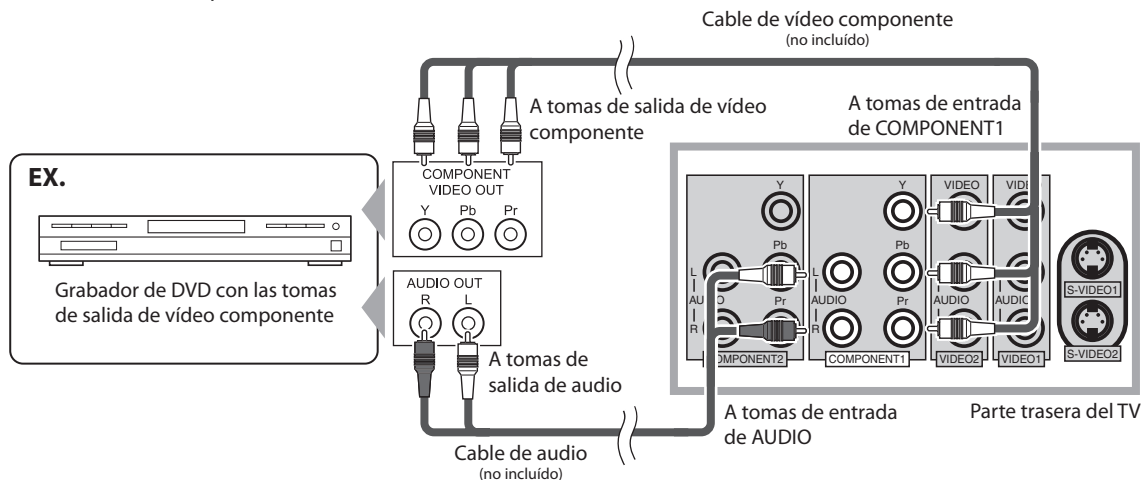

#### NOTA:

• Este TV acepta señales de vídeo de 480i / 480p / 720p / 1080i.

### [CONEXIÓN DE CABLE DE S-VÍDEO]

Ofrece una buena calidad de imagen para dispositivos de vídeo conectados a su TV.

Utilice un cable S-video (no incluido) para conectar su TV a dispositivos externos de vídeo equipados con conectores S-video.

Si conecta la toma de salida S-Video a la toma de entrada S-VIDEO1, conecte un cable de audio a las tomas AUDIO L/R (izquierda/derecha) de VIDEO1.

Si conecta la toma de salida S-Video a la toma de entrada S-VIDEO2, conecte un cable de audio a las tomas AUDIO L/R (izquierda/derecha) de VIDEO2.

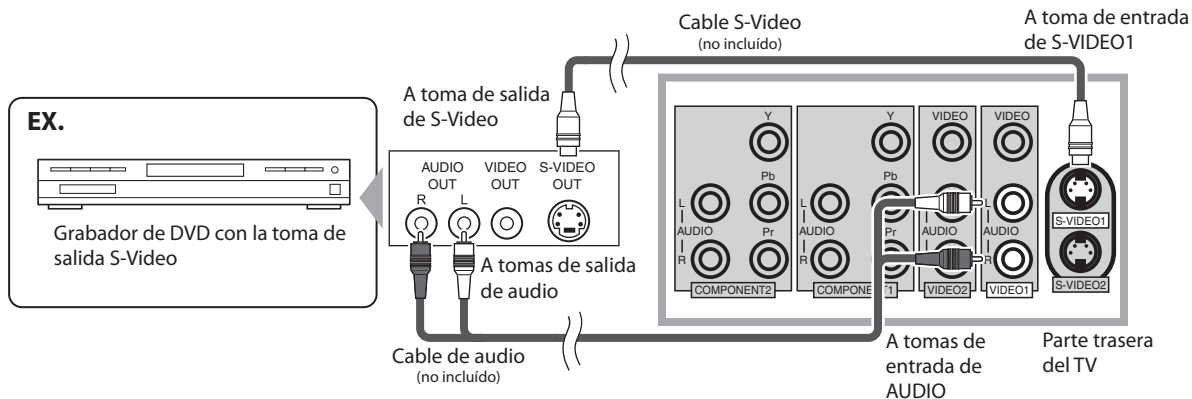

#### NOTA:

• Si se conecta al mismo tiempo al conector S-video y al conector VIDEO será la conexión del S-Video la que tenga prioridad.

**[CONEXIÓN DE VÍDEO]**

Ofrece una calidad de imagen estándar para dispositivos de vídeo conectados al televisor.

Cuando la toma de audio del dispositivo de vídeo es monoaural, conecte el cable de audio a la toma de entrada VIDEO1, conecte un cable de audio a las tomas AUDIO L/R (izquierda/derecha) de VIDEO1.

Si conecta las tomas de salida componente a la toma de entrada VIDEO2, conecte un cable de audio a las tomas AUDIO L/R (izquierda/derecha) de VIDEO2.

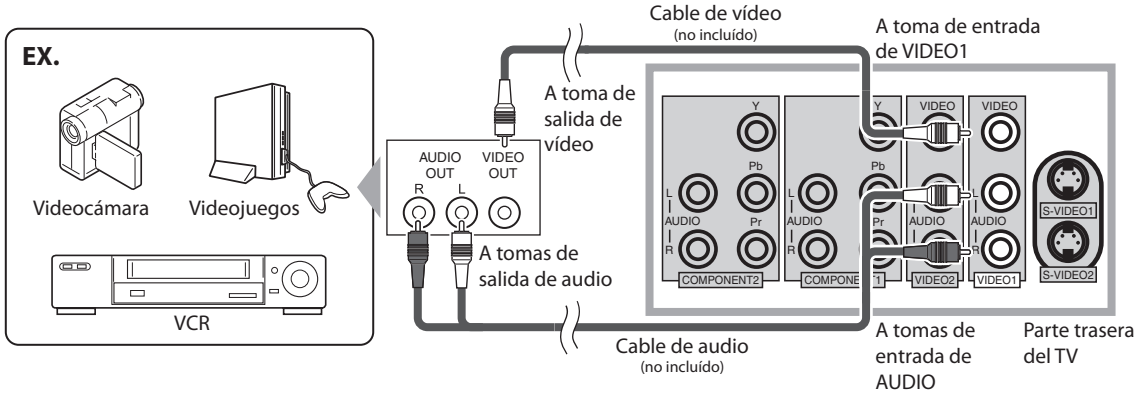

**[CONEXIÓN DE SALIDA DE AUDIO DIGITAL]**

Si conecta este televisor a un dispositivo de audio digital externo, podrá disfrutar de audio multicanal, como por ejemplo el sonido de transmisión digital de 5.1 canales. No se incluye el cable coaxial de audio digital requerido.

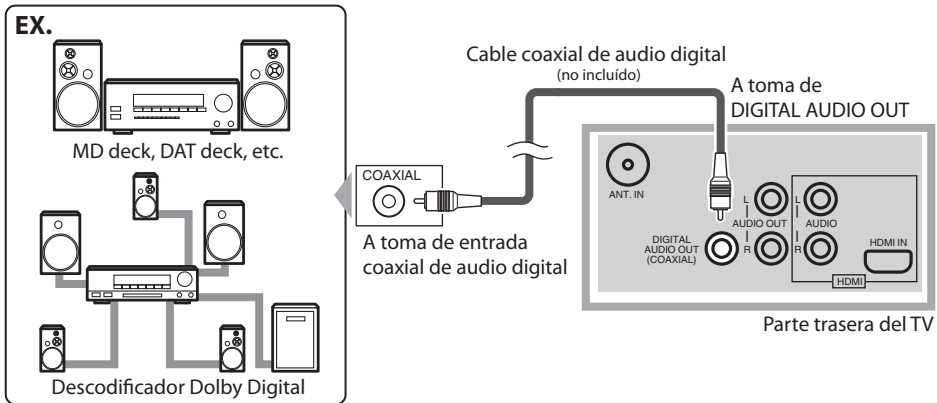

Fabricado bajo licencia de Dolby Laboratories. "Dolby" y el símbolo de la doble D son marcas comerciales de Dolby Laboratories.

**[CONEXIÓN DE SALIDA DE AUDIO ANALÓGICA]**

Si conecta este televisor a un dispositivo de audio analógico externo, podrá disfrutar de sonido estéreo (2 canales). No se incluye el cable de audio requerido.

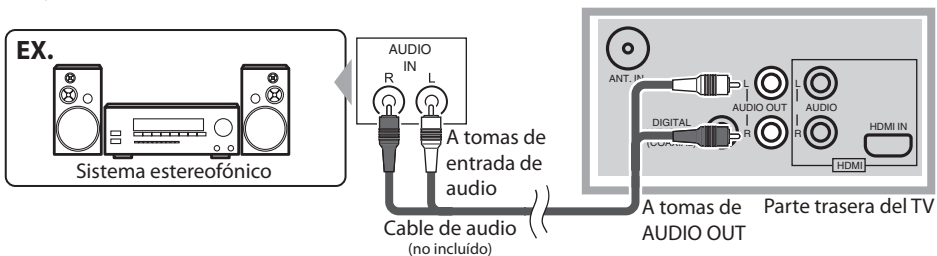

## ✓ PREAJUSTES INICIAL

Esta sección le guiará en la instalación inicial de su televisor, que entre otras cosas requiere seleccionar el idioma para el menú en pantalla y la operación AUTOSCAN, que escanea y memoriza los canales visualizables automáticamente.

**1** Una vez hechas todas las conexiones necesarias, encienda este TV.

**2** Presione **[POWER]** para visualizar el menú de ajuste inicial.



- Esta operación puede tardar unos momentos en empezar.
- Si el menú de Ajuste Inicial no aparece, mantenga presionado **[ENTER]** durante 3 segundos, para que aparezca el ajuste inicial y luego pase al paso 3. Si ya ha completado el ajuste inicial, consulte "SELECCIÓN DE IDIOMA" en página 57.

**3** Al encender el televisor por primera vez, aparecerá la siguiente pantalla. Utilice **[▲/▼]** para seleccionar el idioma del menú en pantalla entre las opciones que aparecen en el margen derecho de la pantalla. (English / Español / Français)



- Aparecerá en pantalla la confirmación de antena en el paso 4 en el idioma seleccionado después de presionar **[ENTER]**.

**4** Utilice **[▲/▼]** para seleccionar la fuente de la toma ANT-IN, y presione **[ENTER]**.



**5** Autoscan se iniciará automáticamente.

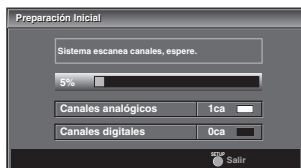

- Cuando se haya terminado la exploración, se mostrará el canal memorizado más pequeño.

### NOTA:

- La función de Autoscan inicial puede ejecutarse para "Aire" o para "Cable" solamente una vez. Cuando cambie la conexión (Aire/Cable), ajuste de nuevo "Autoscan". (Consulte la página 56.)
- Si se conecta al sistema de cable directamente, póngase en contacto con el instalador de sistema de CATV.
- Cuando no termine la exploración, Sugerencias Útiles se visualizará cada vez que usted conecte la alimentación. Si ha registrado canales previamente cuando aparece esta pantalla, puede acceder a ellos con **[los botones de número]**.

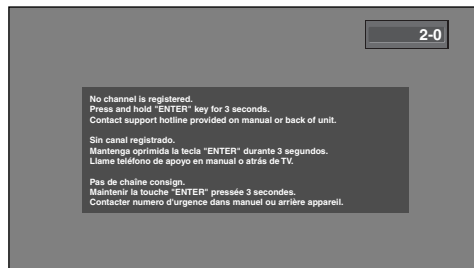

- El número de teléfono del centro de servicio está indicado en la portada de este manual.

## ✓ PREA. AUTO CA.

Con la función AUTOSCAN, el televisor escanea y memoriza automáticamente los canales visualizables en su zona. Active la función AUTOSCAN al encender el televisor por primera vez, al cambiar las fuentes de transmisión (por ej., de antena a televisión por cable), o al trasladar el televisor a una zona de transmisión diferente.

1 Presione **[SETUP]** para visualizar la pantalla de ajuste.

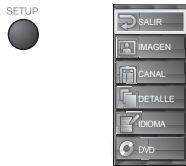

2 Utilice **[▲/▼]** para seleccionar "CANAL", y presione **[ENTER]**.



3 Utilice **[▲/▼]** para seleccionar "Autoscan", y presione **[ENTER]**.



4 Utilice **[▲/▼]** para seleccionar "Aire" para canales de TV o "Cable" para canales CATV, y presione **[ENTER]**.

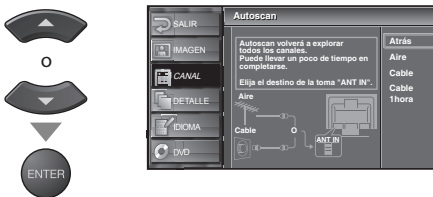

• Se iniciará automáticamente la búsqueda y memorización de los canales.

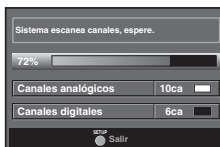

• Cuando finalice este proceso, se mostrará el canal más pequeño memorizado de la emisión.

### NOTA:

- Asegúrese que el TV está conectado a la antena o cable.
- Si desea conectar el sistema de cable directamente, póngase en contacto con el instalador del sistema CATV.
- Si presiona **[POWER]** o **[SETUP]** durante Autoscan, se cancelará este ajuste.
- Si no hay recepción o si se detecta una señal deficiente, aparecerá una Sugerencia en pantalla al finalizar la exploración.

## ✓ LISTA DE CANALES

Esta función le permite eliminar canales no deseados de la lista de registro de canales.

1 Presione **[SETUP]** para visualizar la pantalla de ajuste.



2 Utilice **[▲/▼]** para seleccionar "CANAL", y presione **[ENTER]**.



3 Utilice **[▲/▼]** para seleccionar "Lista Canales", y presione **[ENTER]**.

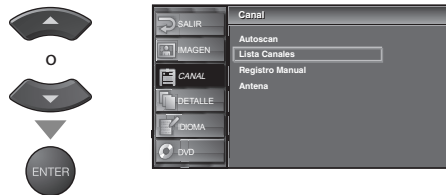

4 Utilice **[▲/▼]** para seleccionar el canal que desea eliminar.



- Presione **[ENTER]** para resaltar el canal seleccionado para su eliminación. No podrá volver a seleccionar el canal con **[CH ▲/▼]**.
- Para reactivar el canal eliminado, resáltelo y presione **[ENTER]**.
- Al eliminar un canal principal, se eliminan también sus canales asociados.

### NOTA:

- El canal con "DTV" indicado en la pantalla es ATSC, de lo contrario el canal es NTSC.
- En la radiodifusión DTV, a veces un canal emite múltiples programas dependiendo de la hora de emisión. En este caso, el canal principal se conoce como canal mayor y el subcanal como canal menor.

5 Para salir del instalación, presione **[SETUP]**.





## ✓ REGISTRO MANUAL

Esta función le permite añadir manualmente canales no memorizados durante la operación de AUTOSCAN debido a la poca fuerza de la señal de transmisión.

1 Presione **[SETUP]** para visualizar la pantalla de ajuste.

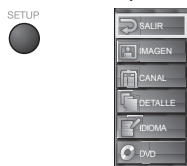

2 Utilice **[▲/▼]** para seleccionar "CANAL", y presione **[ENTER]**.



3 Utilice **[▲/▼]** para seleccionar "Registro Manual", y presione **[ENTER]**.



4 Utilice **[los botones de número]** para seleccionar el canal que desea añadir, y presione **[ENTER]**.



5 Para salir de la instalación, presione **[SETUP]**.



### NOTA:

- Si la configuración se realiza con éxito, aparecerá en pantalla "Registro en lista canales".
- Si la configuración no se realiza con éxito, como en caso de utilizarse Video1, aparece en la pantalla "No disponible".

## ✓ SELECCIÓN DE IDIOMA

Puede elegir su idioma de pantalla entre los siguientes: Inglés, Español o Francés.

1 Presione **[SETUP]** para visualizar la pantalla de ajuste.

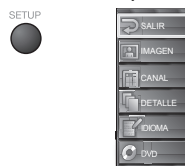

2 Utilice **[▲/▼]** para seleccionar "IDIOMA", y presione **[ENTER]**.



3 Utilice **[▲/▼]** para seleccionar su idioma, y presione **[ENTER]**.



4 Para salir de la instalación, presione **[SETUP]**.



Estas operaciones son controlables desde el mando a distancia. Algunas de ellas también son controlables desde el panel de mando del aparato principal.

## ✓ REPRODUCCIÓN

DVD CD (MP3 JPEG en página 59)

### Antes:

Encienda el amplificador y cualquier otro equipo que esté conectado a esta unidad.

Asegúrese de que el receptor de audio externo (no incluido) está ajustado en el canal correcto.

1 Presione **[POWER]** para encender la unidad.



2 Inserte un disco con la etiqueta orientada hacia a la izquierda desde el lateral derecho de la unidad.



3 La unidad pasa al modo DVD cuando estaba en modo TV y detecta el tipo de disco.



• Presione **[PLAY ▶]** si la unidad no pasa al modo DVD.

4 El disco comienza la reproducción.

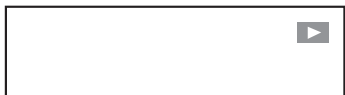

5 Presione **[STOP ■]** para interrumpir la reproducción.



6 Presione **[EJECT]** para expulsar el disco.



### NOTA:

- Para reproducir un disco en formato MP3 o JPEG, consulte los detalles en página 59.
- Puede aparecer un "ícono prohibido" en la zona superior derecha de la pantalla del televisor cuando la operación esté prohibida por el disco o por esta unidad.
- Algunos discos DVD pueden iniciar la reproducción desde el título 2 ó 3 debido a programas específicos.
- Durante la reproducción de un disco de 2 capas, las imágenes pueden interrumpirse durante un instante. Esto sucede mientras la primera capa se está cambiando a la segunda capa. Esto no es un fallo de funcionamiento.

## ✓ MENÚ DVD

DVD

Algunos discos DVD contienen menús que le permiten personalizar la reproducción del DVD.

- Presione **[DISC MENU]** y utilice **[▲ / ▼ / ◀ / ▶]** para seleccionar un elemento y a continuación presione **[ENTER]** (o **[PLAY ▶]**).

### Activar una pantalla de Menú durante la reproducción

- Presione **[DISC MENU]** para activar el menú DVD.
- Presione **[TITLE]** para activar el menú de título.

### NOTA:

- Las operaciones de menú pueden variar según el disco. Para más detalles, consulte el manual del disco.

## ✓ REANUDACIÓN

DVD

CD

MP3

JPEG

Presione **[STOP ■]** durante la reproducción. En la pantalla del televisor aparecerá el mensaje de reanudación.

Presione **[PLAY ▶]** para reanudar la reproducción desde el punto en que se interrumpió..

### REANUDACIÓN ACTIVADA

Presione "PLAY" para reproducir desde aquí. Para reproducir desde el inicio, primero presione "STOP" y luego "PLAY".

### NOTA:

- Para cancelar la información de reanudación, presione de nuevo **[STOP ■]** en el modo de parada. En algunos discos, **[STOP ■]** no funcionará mientras se muestra el mensaje de reanudación. Espere hasta que el mensaje desaparezca.
- La información de reanudación se guardará incluso cuando la unidad se encuentre en modo de espera. En MP3 y JPEG, la reproducción se reanudará desde el comienzo de la pista en la que se interrumpió la reproducción.

## ✓ PAUSA Y REPRODUCCIÓN PASO A PASO

DVD

CD

MP3

JPEG

Presione **[PAUSE II]** durante la reproducción.

• La reproducción se pondrá en pausa y el sonido se silenciará.

• Presione **[PAUSE II]** una vez durante la reproducción doble/carpeta para poner en pausa un archivo JPEG solamente. Presione **[PAUSE II]** nuevamente para poner en pausa una pista MP3.

Para continuar la reproducción, presione **[PLAY ▶]**.

DVD

El disco avanza fotograma a fotograma cada vez que se presiona **[PAUSE II]** en el modo de pausa.

Para continuar la reproducción, presione **[PLAY ▶]**.

### NOTA:

- Ajuste "MODO VISTA FIJA" en "IMAGEN", en el ajuste "OTROS"; si las imágenes aparecen borrosas en el modo de pausa.

## ✓ AVANCE RÁPIDO / RETROCESO RÁPIDO

DVD CD MP3

Presione **[FWD ►►]** o **[REV ◀◀]** repetidamente durante la reproducción para seleccionar la velocidad de avance o retroceso necesaria.

Para continuar la reproducción, presione **[PLAY ►]**.

### NOTA:

- Ajuste "MODO VISTA FIJA" en "IMAGEN", en el ajuste "OTROS", si las imágenes aparecen borrosas en el modo de reproducción rápida.
- La velocidad de búsqueda de avance o retroceso rápido es diferente según el disco. La velocidad aproximada es 1(2X), 2(8X), 3(20X), 4(50X) y 5(100X) en discos DVD y 1(2X), 2(8X) y 3(30X) en discos CD Audio y MP3.
- En discos CD Audio y MP3, el sonido se escuchará durante la búsqueda de avance o retroceso rápido.

## ✓ AVANCE LENTO / RETROCESO LENTO

DVD

Presione **[FWD ►►]** o **[REV ◀◀]** repetidamente durante el modo de pausa para seleccionar la velocidad de avance o retroceso necesaria.

Para continuar la reproducción, presione **[PLAY ►]**.

### NOTA:

- La velocidad de avance o retroceso lentos varía según el disco. La velocidad aproximada es 1 (1/16), 2 (1/8) y 3 (1/2).
- Ajuste "MODO VISTA FIJA" en "IMAGEN", en el ajuste "OTROS", si las imágenes aparecen borrosas en el modo de reproducción lenta.

## ✓ REPRODUCCIÓN DE MP3, JPEG

MP3 JPEG

MP3 o JPEG son métodos de compresión de archivos. Puede copiar archivos MP3 o JPEG en discos CD-RW/-R desde su ordenador y reproducir los archivos en esta unidad.

1 Inserte un disco en formato MP3 o JPEG, la reproducción empezará automáticamente.

- Presione **[PLAY ►]** si ya se ha insertado un disco en formato MP3 o JPEG.
- Presione **[DISC MENU]** cuando quiera activar la LISTA DE ARCHIVOS.

**Cuando seleccione la carpeta:**

- Presione **[►]** cuando quiera ir a la siguiente jerarquía.



- Presione **[◀]** cuando quiera volver a la jerarquía anterior (excepto la jerarquía de primer nivel).
- Si se presiona **[TITLE]** cuando se visualiza una LISTA DE ARCHIVOS, se resaltará el primer elemento de la jerarquía de primer nivel.
- Presione **[DISC MENU]** o **[BACK/RETURN]** para volver a la pantalla de reproducción.

2 Presione **[STOP ■]** una vez para interrumpir la reproducción temporalmente.



- Consulte "REANUDACIÓN" en página 58.

### NOTA:

- Algunas selecciones pueden tardar un tiempo en ser reconocidas.
- Las carpetas son conocidas como Grupos; los archivos son conocidos como Pistas.
- Las carpetas, archivos MP3 y archivos JPEG se visualizan respectivamente como , y .
- En un disco pueden reconocerse un máximo de 255 carpetas o 999 archivos.
- En una carpeta pueden reconocerse hasta 8 jerarquías. Los archivos situados en las carpetas novena o más profundas no pueden reproducirse.
- Esta unidad puede reproducir imágenes y sonidos desde datos grabados en formatos MP3 y JPEG en discos CD-RW/-R.
- Un archivo con una extensión ".mp3 (MP3)" se denomina "archivo MP3".
- Un archivo con una extensión ".jpg (JPG)" o ".jpeg (JPEG)" se denomina "archivo JPEG".
- Exif es un formato de archivo, el formato "Exchangeable Image File" (archivo de imagen intercambiable) creado por la Asociación Japonesa de Desarrollo de la Industria Electrónica (JEIDA).
- Los archivos con extensión distinta de ".mp3 (MP3)", ".jpg (JPG)" y ".jpeg (JPEG)" no aparecerán en el menú MP3 o JPEG.
- Si el archivo no está grabado en formato MP3 o JPEG, puede producirse ruido incluso aunque la extensión del archivo esté en ".mp3 (MP3)", ".jpg (JPG)" o ".jpeg (JPEG)".
- El nombre de grupo y pista puede visualizarse en hasta 25 caracteres. Los caracteres no reconocibles serán sustituidos por asteriscos.
- Los grupos o pistas no reproducibles pueden visualizarse, según las condiciones de grabación.
- Los archivos JPEG progresivo (archivos JPEG guardados en formato progresivo) no se reproducirán en esta unidad.

# **SYLVANIA**

## **LIMITED WARRANTY**

FUNAI CORP. will repair this product, free of charge in the USA in the event of defect in materials or workmanship as follows:

### **DURATION:**

**PARTS:** FUNAI CORP. will provide parts to replace defective parts without charge for one (1) year from the date of original retail purchase. Certain parts and LCD image burn-in are excluded from this warranty.

**LABOR:** FUNAI CORP. will provide the labor without charge for a period of ninety (90) days from the date of original retail purchase.

### **LIMITS AND EXCLUSIONS:**

THIS WARRANTY IS EXTENDED ONLY TO THE ORIGINAL RETAIL PURCHASER. A PURCHASE RECEIPT OR OTHER PROOF OF ORIGINAL RETAIL PURCHASE WILL BE REQUIRED TOGETHER WITH THE PRODUCT TO OBTAIN SERVICE UNDER THIS WARRANTY.

This warranty shall not be extended to any other person or transferee.

This warranty is void and of no effect if any serial numbers on the product are altered, replaced, defaced, missing or if service was attempted by an unauthorized service center. This limited warranty does not apply to any product not purchased and used in the United States.

This warranty only covers failures due to defects in material or workmanship which occur during normal use. It does not cover damage which occurs in shipment, or failures which are caused by repairs, alterations or products not supplied by FUNAI CORP., or damage, which results from accident, misuse, abuse, mishandling, misapplication, alteration, faulty installation, improper maintenance, commercial use such as hotel, rental or office use of this product, or damage which results from fire, flood, lightning or other acts of God.

THIS WARRANTY DOES NOT COVER PACKING MATERIALS, ANY ACCESSORIES (EXCEPT REMOTE CONTROL), ANY COSMETIC PARTS, COMPLETE ASSEMBLY PARTS, DEMO OR FLOOR MODELS.

FUNAI CORP. AND ITS REPRESENTATIVES OR AGENTS SHALL IN NO EVENT BE LIABLE FOR ANY GENERAL, INDIRECT OR CONSEQUENTIAL DAMAGES ARISING OUT OF OR OCCASIONED BY THE USE OF OR THE INABILITY TO USE THIS PRODUCT. THIS WARRANTY IS MADE IN LIEU OF ALL OTHER WARRANTIES, EXPRESS OR IMPLIED, AND OF ALL OTHER LIABILITIES ON THE PART OF FUNAI, ALL OTHER WARRANTIES INCLUDING THE WARRANTY OF MERCHANTABILITY AND FITNESS FOR A PARTICULAR PURPOSE, ARE HEREBY DISCLAIMED BY FUNAI AND ITS REPRESENTATIVES IN THE UNITED STATES.

ALL WARRANTY INSPECTIONS AND REPAIRS MUST BE PERFORMED BY AN AUTHORIZED SERVICE CENTER. THIS WARRANTY IS ONLY VALID WHEN THE UNIT IS CARRIED-IN TO AN AUTHORIZED SERVICE CENTER.

THE PRODUCT MUST BE ACCOMPANIED BY A COPY OF THE ORIGINAL RETAIL PURCHASE RECEIPT. IF NO PROOF OF PURCHASE IS ATTACHED, THE WARRANTY WILL NOT BE HONORED AND REPAIR COSTS WILL BE CHARGED.

### **IMPORTANT:**

THIS LIMITED WARRANTY GIVES YOU SPECIFIC LEGAL RIGHTS. YOU MAY HAVE OTHER RIGHTS THAT VARY FROM STATE TO STATE. IF, AT ANY TIME DURING THE WARRANTY PERIOD, YOU ARE UNABLE TO OBTAIN SATISFACTION WITH THE REPAIR OF THIS PRODUCT, PLEASE CONTACT FUNAI CORP.

### **ATTENTION:**

FUNAI CORP. RESERVES THE RIGHT TO MODIFY ANY DESIGN OF THIS PRODUCT WITHOUT PRIOR NOTICE.

### **WARRANTY STATEMENT REGARDING NON AUTHORIZED REPAIRS:**

To obtain warranty service, you must take the product, or deliver the product freight prepaid, in either its original packaging or packaging affording an equal degree of protection, to any AUTHORIZED SERVICE CENTER. FUNAI CORP. will not reimburse you for any service done by unauthorized service providers without prior written approval.

To locate your nearest AUTHORIZED SERVICE CENTER or for general service inquiries, please contact us at:

FUNAI CORPORATION  
Customer Service

**Tel : 1-800-968-3429**

**<http://www.SylvaniaConsumerElectronics.com>**

19900 Van Ness Avenue, Torrance, CA 90501