

Features

Regulated Converter

- 12:1 ultra wide input voltage range
- 3kVDC/1 minute reinforced insulation
- High efficiency over entire input voltage range
- -40°C to +85°C temperature range without cooling or derating
- Output voltage sense and trim
- CE marked

RECOM DC/DC Converter

RP40Q-RUW

**40 Watt
Quarter
Brick
Single Output**

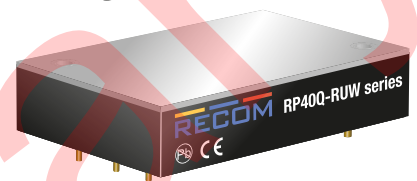

Description

The quarter-brick RP40Q series DC/DC converter is designed for railway rolling stock and high voltage battery applications. It has a 12:1 input voltage range to cover all input voltages from nominal 24VDC up to 110VDC in a single product (including EN50155 transients) and offers isolated and regulated 5V, 12V, 15V, 24V or 48VDC outputs with sense and trim pins. The converter has a consistently high efficiency over the entire input voltage range and has an operating temperature range from -40°C to +85°C without forced air cooling or derating. The case is fitted with threaded inserts for secure mounting in high shock and vibration environments. The converter is CE marked and comes with a three year warranty.

Selection Guide

Part Number	Nom. Input Voltage Range [VDC]	Output Voltage [VDC]	Output Current [A]	Efficiency typ. (1) [%]	Max. Capacitive Load (2) [µF]
RP40Q-11005SRUW/N(3,4)	16-160	5	8	91	16000
RP40Q-11012SRUW/N(3,4)	16-160	12	3.33	90	2800
RP40Q-11015SRUW/N(3,4)	16-160	15	2.67	90	1800
RP40Q-11024SRUW/N(3,4)	16-160	24	1.67	90	720
RP40Q-11048SRUW/N(3,4)	16-160	48	0.83	89	180

Notes:

- Note1: Efficiency is tested at 48Vin and full load at +25°C ambient
 Note2: Max. Cap Load is tested at nominal input and full resistive load

IEC/EN62368-1 pending
 EN60950-1 pending
 EN50155 pending
 EN55032
 EN55024
 CE marked

Model Numbering

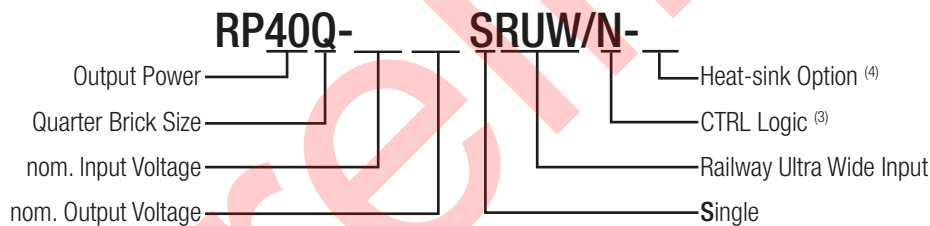

Notes:

- Note3: standard part is with suffix "/N" for negative logic (1=ON, 0=OFF) or add suffix "/P" for positive logic (0=ON, 1=OFF)
 Note4: add suffix "-HC" for screwed Heat-sink

Ordering Examples

- RP40Q-11005SRUW/N = 110V Input Voltage, 5V Output Voltage, Single, negative logic
 RP40Q-11048SRUW/P = 110V Input Voltage, 48V Output Voltage, Single, positive logic
 RP40Q-11024SRUW/N-HC = 110V Input Voltage, 24V Output Voltage, Single, negative logic and fitted Heat-sink
 RP40Q-11015SRUW/P-HC = 110V Input Voltage, 15V Output Voltage, Single, positive logic and fitted Heat-sink



https://www.recom-power.com/pdf/Powerline_DC-DC/RSPxxx-168.pdf

Specifications (measured @ Ta= 25°C, nom. Vin, full load and after warm-up unless otherwise stated)

BASIC CHARACTERISTICS

Parameter	Condition		Min.	Typ.	Max.
Internal Input Filter					Pi-Type
Input Voltage Range	nom. Vin = 110VDC		16VDC	110VDC	160VDC
Input Surge Voltage	< 1s	nom. Vin = 110VDC			185VDC
Under Voltage Lockout (ULVO)	nom. Vin = 110VDC	DC-DC ON DC-DC OFF	10VDC	11VDC	14VDC 12VDC
Input Current Range	Vin = 16VDC Vin = 110VDC Vin = 160VDC			2.75A 0.4A 0.27A	3.5A
Quiescent Current	nom. Vin = 110VDC			10mA	
Output Voltage Trimming			-20%		+10%
Minimum Load			0%		
Start-up Time	constant resistive load			75ms	100ms
Rise Time				40ms	
Hold-up Time				65ms	
ON/OFF Control ⁽⁵⁾	Positive Logic	DC-DC ON DC-DC OFF	Open or $3 < V_{CTRL} < 12VDC$ Short or $0 < V_{CTRL} < 1.2VDC$		
	Negative Logic	DC-DC ON DC-DC OFF	Short or $0 < V_{CTRL} < 1.2VDC$ Open or $3 < V_{CTRL} < 12VDC$		
Input Current of CTRL pin			-0.5mA		1mA
Standby Current	DC-DC OFF			4mA	
Internal Operating Frequency				180kHz	
Output Ripple and Noise ⁽⁶⁾	measured at 20MHz BW		5Vout 12, 15Vout 24Vout 48Vout	75mVp-p 100mVp-p 200mVp-p 300mVp-p	
Remote Sense ⁽⁷⁾					10%

Notes:

- Note5: The ON/OFF control function can be positive or negative logic. The pin voltage is referenced to -Vin pin
- Note6: Measurements are made for 5Vout with a 1µF/25V X7R MLCC and a 22µF/25V E-Cap; for 15Vout with a 22µF/25V X7R MLCC, for 24Vout with a 4.7µF/50V X7R MLCC and for 48Vout with a 2.2µF/100V X7R MLCC
- Note7: Refer to page PB-5 Remote Sense. If not used connect Remote Sense pins to corresponding output pins

RP40Q-11005SRW

Efficiency vs. Output Load

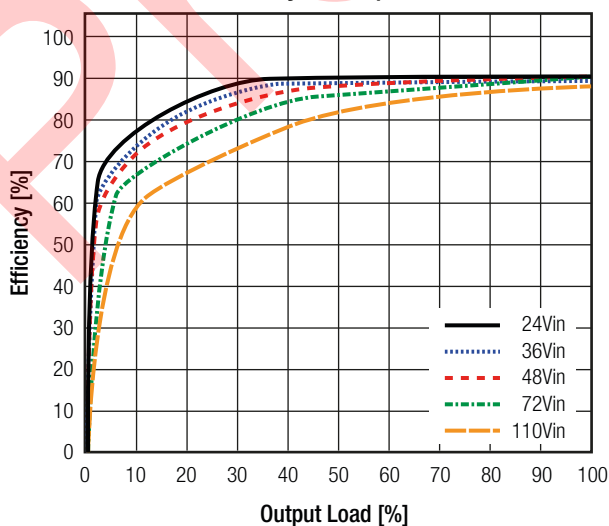

Efficiency vs. Input Voltage

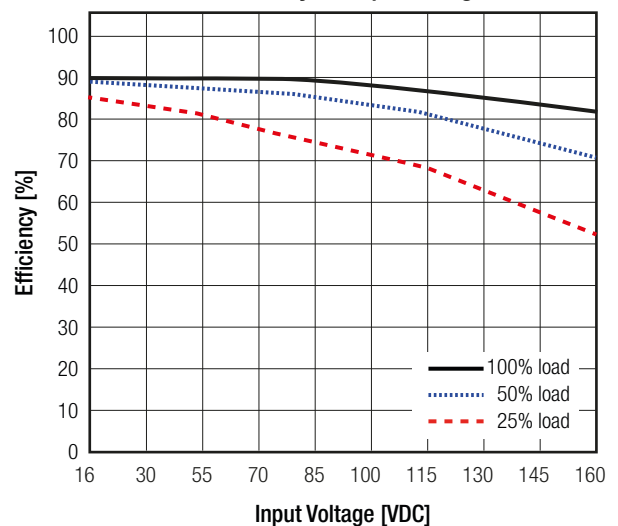

continued on next page

Specifications (measured @ Ta= 25°C, nom. Vin, full load and after warm-up unless otherwise stated)

RP40Q-11005SRW

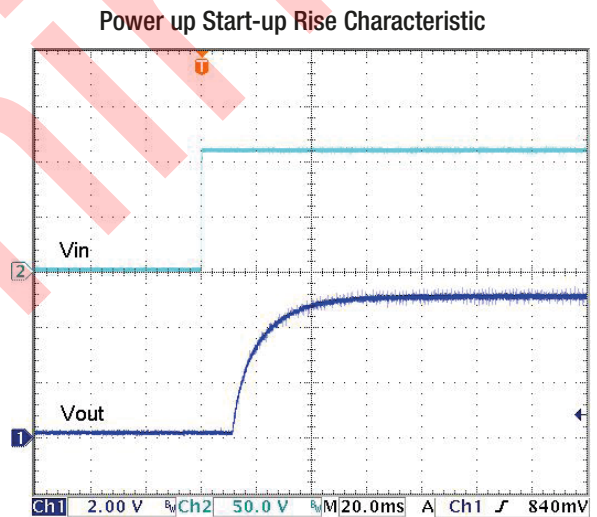
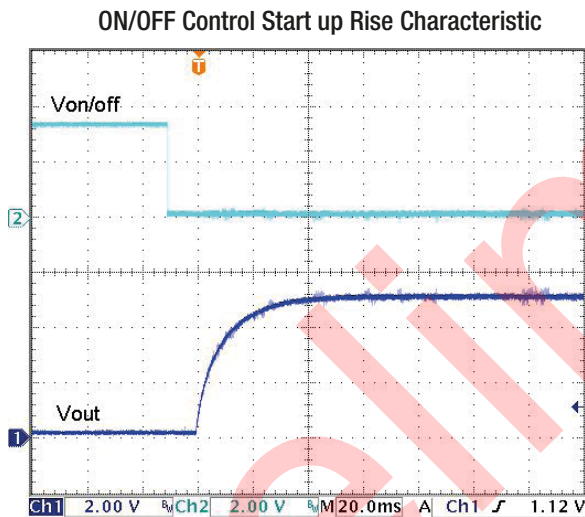
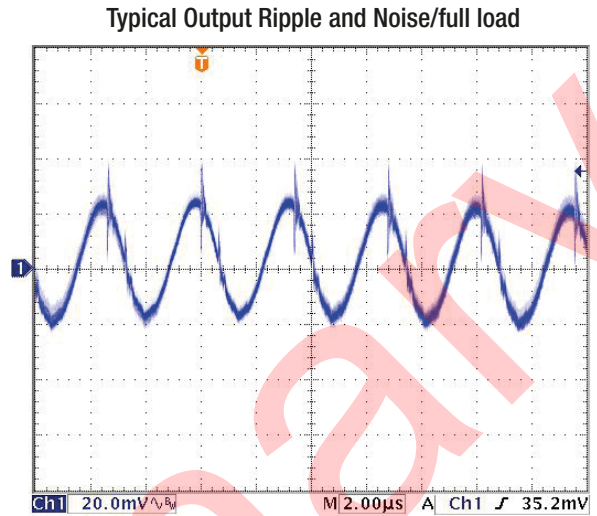
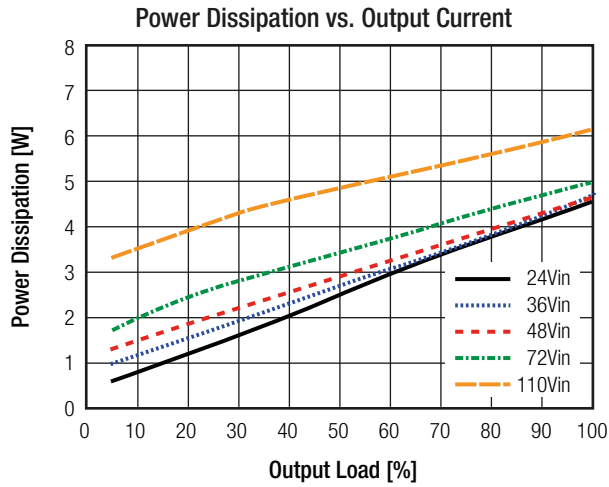

Input Voltage Range

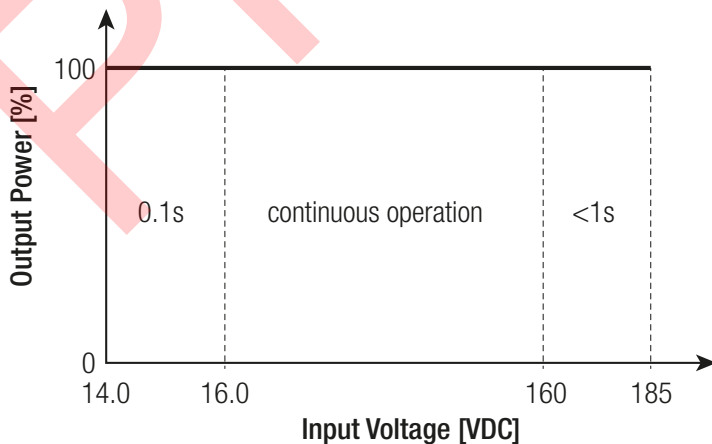

Continuous full power operation is rated between 16V and 160V, including full load start-up.

Once running, the converter will operate for short periods of time over an extended input voltage range down to 14V and up to 185V, thus covering all EN50155 under-voltage and over-voltage transient conditions.

Specifications (measured @ Ta= 25°C, nom. Vin, full load and after warm-up unless otherwise stated)

OUTPUT VOLTAGE TRIMMING

Output Voltage Trimming

It allows the user to increase or decrease the output voltage of the module. This is accomplished by connecting an external resistor between the Trim pin and either the +Sense or -Sense pins. With an external resistor between the Trim and +Sense pin, the output voltage increases. With an external resistor between the Trim and -Sense pin, the output voltage decreases. The external Trim resistor needs to be at least 1/8W of rated. The values for trim resistors shown in trim tables below are according to standard E96 values; therefore, the specified voltage may slightly vary.

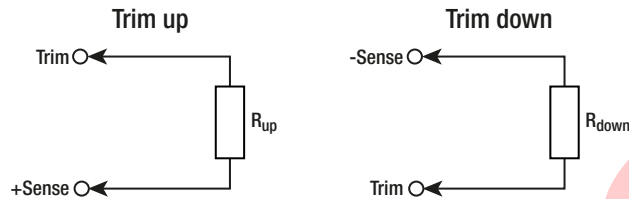

V_{out_nom} = nominal output voltage [VDC]
 ΔV_{out} = output voltage change [%]
 V_{ref} = reference voltage [VDC]
 R_{up} = trim up resistor [Ω]
 R_{down} = trim down resistor [Ω]
 R_1, R_2, R_3 = internal resistors [Ω]

V_{out_nom}	R_1	R_2	R_3	V_{ref}
5VDC	10k2 Ω	511k Ω	5k11	1.225VDC
12VDC				
15VDC				
24VDC				
48VDC				

Calculation:

$$R_{up} = \left[\frac{R_3 \times V_{out_nom} \times (100 + \Delta V_{out})}{V_{ref} \times \Delta V_{out}} \right] - \left[\frac{(R_1 \times \Delta V_{out}) + R_2}{\Delta V_{out}} \right]$$

$$R_{down} = \left[\frac{R_2}{\Delta V_{out}} \right] - R_1$$

Practical Example RP60Q-xx05SRW +10% / -10%

$$R_{up} = \left[\frac{5k11 \times 5 \times (100 + 10)}{1.225 \times 10} \right] - \left[\frac{(10k2 \times 10) + 511k}{10} \right] = 168k\Omega$$

$$R_{down} = \left[\frac{511k}{10} \right] - 10k2 = 40k9\Omega$$

R_{up} according to E96 \approx 169k Ω

R_{down} according to E96 \approx 41k2 Ω

RP40Q-xx05SRW

Trim up	1	2	3	4	5	6	7	8	9	10	[%]
$V_{out_set} =$	5.05	5.10	5.15	5.20	5.25	5.30	5.35	5.4	5.45	5.50	[VDC]
R_{up} (E96) \approx	1M58	806k	536k	402k	324k	247k	237k	205k	187k	169k	[Ω]

RP40Q-xx12SRW

Trim up	1	2	3	4	5	6	7	8	9	10	[%]
$V_{out_set} =$	12.12	12.24	12.36	12.48	12.60	12.72	12.84	12.96	13.08	13.20	[VDC]
R_{up} (E96) \approx	4M53	2M26	1M54	1M15	931k	787k	681k	604k	536k	487k	[Ω]

RP40Q-xx15SRW

Trim up	1	2	3	4	5	6	7	8	9	10	[%]
$V_{out_set} =$	15.15	15.30	15.45	15.60	15.75	15.90	16.05	16.20	16.35	16.50	[VDC]
R_{up} (E96) \approx	5M76	2M94	1M96	1M47	1M21	1M02	866k	768k	698k	619k	[Ω]

continued on next page

Specifications (measured @ Ta= 25°C, nom. Vin, full load and after warm-up unless otherwise stated)

OUTPUT VOLTAGE TRIMMING

RP40Q-xx24SRW

Trim up	1	2	3	4	5	6	7	8	9	10	[%]
Vout _{set} =	24.24	24.48	24.72	24.96	25.20	25.44	25.68	25.92	26.16	26.40	[VDC]
R _{up} (E96) ≈	9M53	4M7	3M24	2M94	2M	1M69	1M47	1M27	1M15	1M05	[Ω]

RP40Q-xx48SRW

Trim up	1	2	3	4	5	6	7	8	9	10	[%]
Vout _{set} =	48.48	48.96	49.44	49.92	50.40	50.88	51.36	51.84	52.32	52.80	[VDC]
R _{up} (E96) ≈	19M6	9M94	6M65	5M11	4M12	3M4	3M01	2M61	2M37	2M15	[Ω]

Trim Down all Vout's

Trim down	1	2	3	4	5	6	7	8	9	10	[%]
R _{down} (E96) ≈	499k	243k	162k	118k	90k9	75k	63k4	53k6	46k4	41k2	[Ω]

Trim down	11	12	13	14	15	16	17	18	19	20	[%]
R _{down} (E96) ≈	36k5	32k4	28k7	26k1	23k7	21k5	19k6	18k2	16k5	15k4	[Ω]

REMOTE SENSE

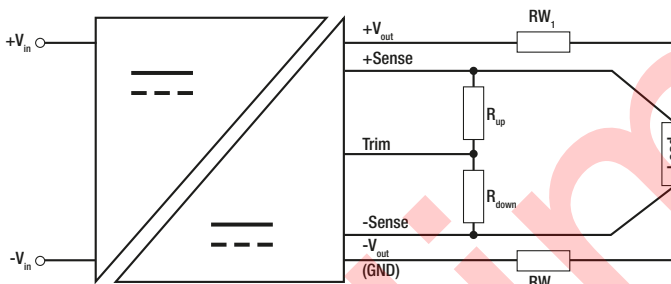

The output voltage can be adjusted by both trim and remote sense. The maximum combined adjustment range is ±10%. Derate the maximum output power if using the trim or sense function to increase the output voltage.

- RW₁ ... wire losses +
- RW₂ ... wire losses -
- R_{up} ... trim up resistor
- R_{down} ... trim down resistor

REGULATION

Parameter	Condition	Value
Output Accuracy		±1.0% max.
Line Regulation	low line to high line	±0.1% max.
Load Regulation	0% load to 100% load	0.1% max.
Transient Response	25% load step change	250µs typ.

Transient Response to Dynamic Load change from 100% to 75% to 100% of Full Load at nom. Vin

RP40Q-11005SRUW

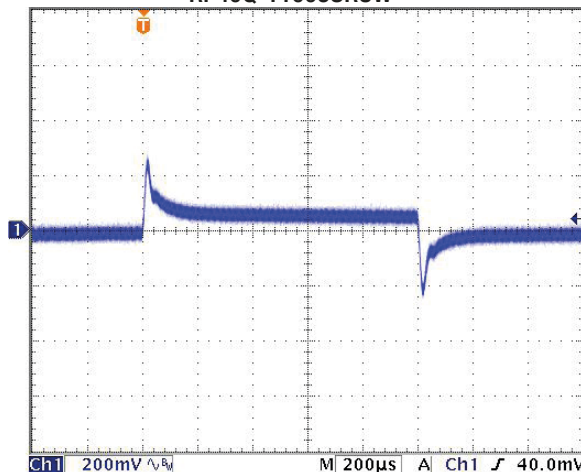

Specifications (measured @ Ta= 25°C, nom. Vin, full load and after warm-up unless otherwise stated)

PROTECTION

Parameter	Condition		Value
Short Circuit Protection (SCP)	below 100mΩ		continuous, hiccup mode, automatic recovery
Over Voltage Protection (OVP)			120-135%, hiccup mode
Over Current Protection (OCP)			120-140%, hiccup mode
Over Temperature Protection (OTP)			+115°C ±5°C
Isolation Voltage ⁽⁸⁾	nom. Vin = 110Vin	I/P to O/P I/P, O/P to Baseplate	rated for 1 minute rated for 1 minute
Isolation Resistance	tested with 500VDC		1GΩ min.
Isolation Capacitance			1000pF max.
Leakage Current			2250µA
Insulation Grade	nom. Vin = 110Vin		reinforced

Notes:

Note8: For repeat Hi-Pot testing, reduce the time and/or the test voltage

Note9: Refer to local safety regulations if input over-current protection is also required. Recommended fuse: T5A slow blow type

ENVIRONMENTAL

Parameter	Condition		Value
Operating Temperature Range	refer to thermal calculation		-40°C to +105°C
Maximum Baseplate Temperature			+110°C
Temperature Coefficient			±0.02%/K
Thermal Impedance	vertical direction by natural convection (0.1m/s)	without Heat-sink with Heat-sink	6.3K/W 5.0K/W
Operating Humidity			5%-95% RH
Thermal Shock			according to EN61373 standard
Vibration			according to EN61373 standard
Fire Protection on Railway Vehicles			according to EN45545 standard
MTBF	according to MIL-HDBK-217F standard, G.B.	+25°C +85°C	880 x 10 ³ hours 150 x 10 ³ hours

Thermal Calculation:

$$R_{th} = \left[\frac{T_{baseplate\ max} - T_{amb}}{P_{diss}} \right]$$

$$P_{diss} = \left[\frac{P_{out\ set}}{\eta} \right] - P_{out\ set}$$

 T_{baseplate max.} = baseplate temperature [°C]

 T_{amb} = ambient temperature [°C]

 P_{out nom.} = nom. output power [W]

 P_{out set} = output power set [W]

 P_{diss} = internal losses [W]

 R_{th} = thermal impedance [K/W]

η = efficiency under given operating conditions [%]

continued on next page

Specifications (measured @ Ta= 25°C, nom. Vin, full load and after warm-up unless otherwise stated)

Practical Example:

Take the **RP40Q-11005SRUW** with 48V Input Voltage and 50% load, natural convection 0.1m/s, in vertical application. What is the maximum ambient operating temperature?

$$\begin{aligned}
 T_{\text{baseplate max.}} &= 110^{\circ}\text{C} \\
 P_{\text{out nom.}} &= 40\text{W} \\
 P_{\text{out set}} &= 40 \times 0.5 = 20\text{W} \\
 R_{\text{th}} &= 6.3\text{K/W (vertical)} \\
 \eta &= 91\% \text{ (Graph)} \\
 P_{\text{diss}} &= \left[\frac{20}{0.91} \right] - 20 = 1.98\text{W} \\
 R_{\text{th}} &= \left[\frac{T_{\text{baseplate max.}} - T_{\text{amb}}}{P_{\text{diss}}} \right] \\
 6.3 &= \frac{110 - T_{\text{amb}}}{1.98} \\
 T_{\text{amb}} &= \underline{97.5^{\circ}\text{C}}
 \end{aligned}$$

Derating Graph

(@ Chamber - tested with double layer PCB: 160x100mm 105µm Eurocard)

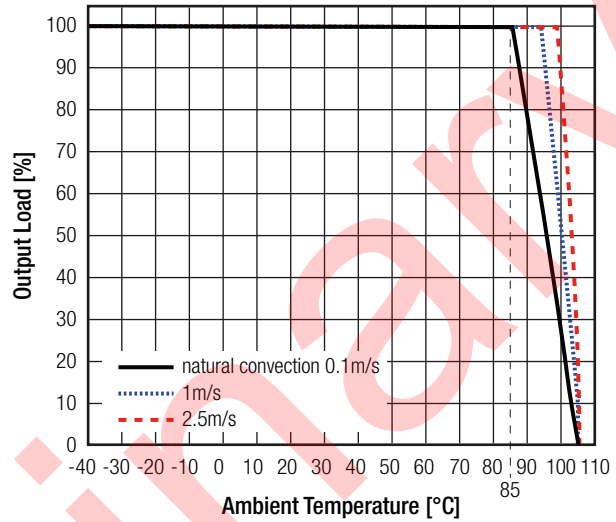

Take the **RP40Q-11005SRUW-HC** with 48V Input Voltage, 50% load, natural convection 0.1m/s, in vertical application and Heat-sink. What is the maximum ambient operating temperature?

$$\begin{aligned}
 T_{\text{baseplate max.}} &= 110^{\circ}\text{C} \\
 P_{\text{out nom.}} &= 40\text{W} \\
 P_{\text{out set}} &= 40 \times 0.5 = 20\text{W} \\
 R_{\text{th}} &= 5.0\text{K/W (vertical)} \\
 \eta &= 91\% \text{ (Graph)} \\
 P_{\text{diss}} &= \left[\frac{20}{0.91} \right] - 20 = 1.98\text{W} \\
 R_{\text{th}} &= \left[\frac{T_{\text{baseplate max.}} - T_{\text{amb}}}{P_{\text{diss}}} \right] \\
 5.0 &= \frac{110 - T_{\text{amb}}}{1.98} \\
 T_{\text{amb}} &= \underline{100^{\circ}\text{C}}
 \end{aligned}$$

Derating Graph

(@ Chamber - tested with double layer PCB: 160x100mm 105µm Eurocard)

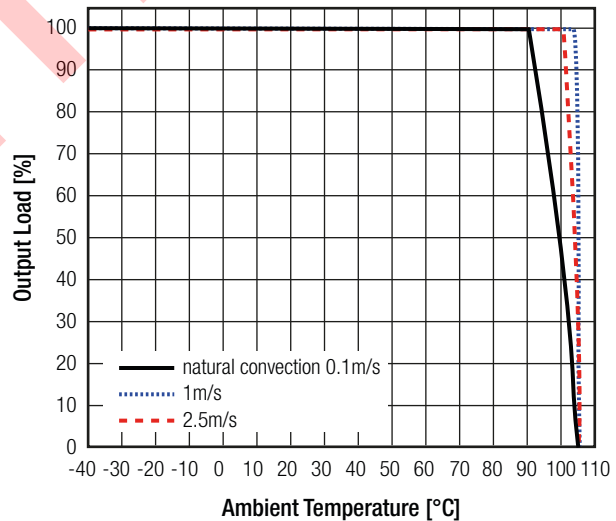

SAFETY AND CERTIFICATIONS

Certificate Type (Safety)	Report / File Number	Standard
Audio/video, information and communication technology equipment. Safety requirements	pending	EN62368-1:2014 + A11:2017 IEC62368-1:2014 2nd Edition
Information technology equipment - General requirements for safety	pending	EN60950-1:2006 + A2:2013
Railway applications - Electrical equipment used on rolling stock	pending	EN50155, 1st Edition, 2007
RoHS 2+		RoHS 2011/65/EU + AM2015/863

continued on next page

Specifications (measured @ Ta= 25°C, nom. Vin, full load and after warm-up unless otherwise stated)

EMC Compliance	Condition	Standard / Criterion
Electromagnetic compatibility of multimedia equipment - Emission requirements	with external filter	EN55032:2015
Information technology equipment - Immunity characteristics - Limits and methods of measurement		EN55024:2010 + A1:2015
ESD Electrostatic discharge immunity test		EN61000-4-2:2008
Radiated, radio-frequency, electromagnetic field immunity test		EN61000-4-3:2006 + A2:2010
Fast transient and burst immunity		EN61000-4-4:2012
Surge immunity		EN61000-4-5:2014
Immunity to conducted disturbances, induced by radio-frequency fields		EN61000-4-6:2013
Power magnetic field immunity		EN61000-4-8:2009+F19

Notes:

Note10: An external input filter capacitor is required if the module has to meet EN61000-4-4 and EN61000-4-5
 Recom suggests: 2 pcs. 150µF/250V connected in parallel

DIMENSIONS and PHYSICAL CHARACTERISTICS

Parameter	Type	Value
Material	baseplate	aluminum
	case	plastic (UL94V-0)
	potting	low smoke silicone (UL94V-0)
Dimensions (LxWxH)	without Heat-sink	57.9 x 36.8 x 12.7mm
	with Heat-sink	57.9 x 36.8 x 25.4mm
Weight	without Heat-sink	64.0g typ.
	with Heat-sink	88.0g typ.

Dimension Drawing (mm)

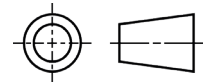
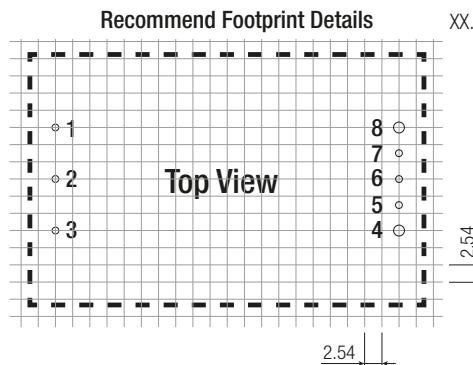
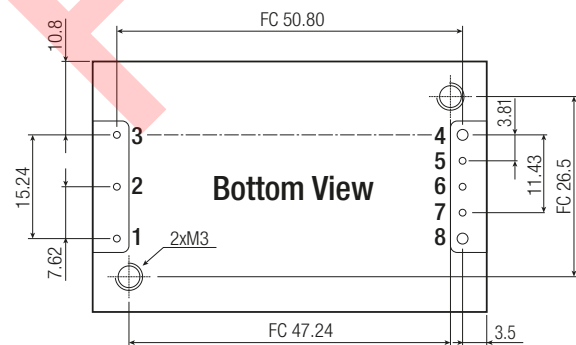
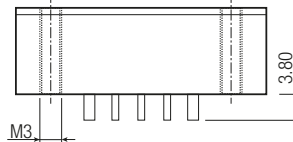
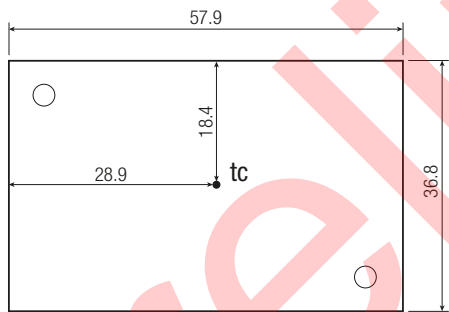

Pin Connections

Pin #	Single
1	+Vin
2	CTRL
3	-Vin
4	-Vout
5	-Sense
6	Trim
7	+Sense
8	+Vout

recommended tightening torque: 0.34Nm
 FC= Fixing Centers for Heat-sink
 XX.X ± 0.5mm
 XX.XX ± 0.25mm

continued on next page

Specifications (measured @ Ta= 25°C, nom. Vin, full load and after warm-up unless otherwise stated)

Dimension Drawing Heat-sink (mm)

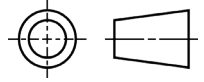
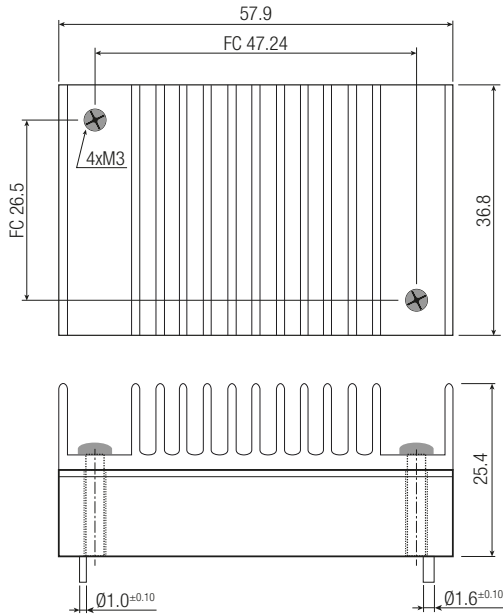

BLOCK DIAGRAM

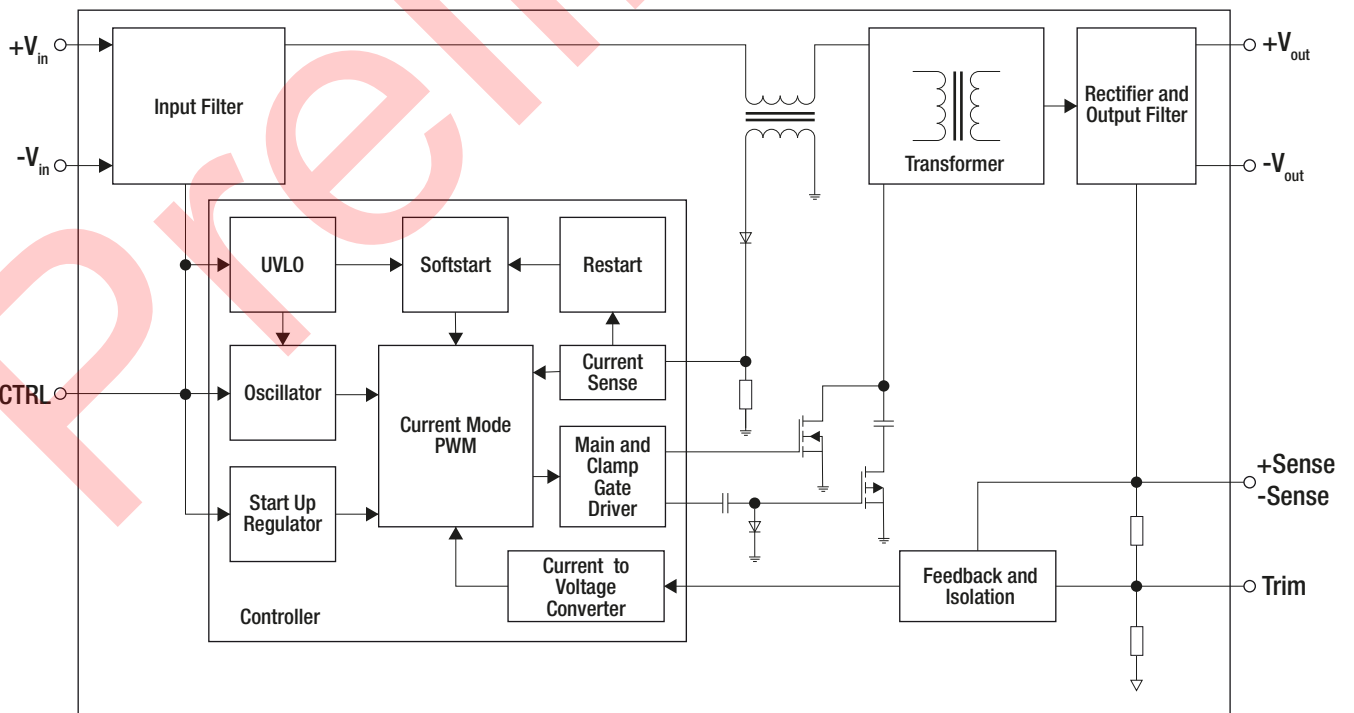

Specifications (measured @ Ta= 25°C, nom. Vin, full load and after warm-up unless otherwise stated)**PACKAGING INFORMATION**

Parameter	Type		Value
	tray	without Heat-sink with Heat-sink	
Packaging Dimension			157.0 x 88.0 x 12.8mm 157.0 x 88.0 x 24.8mm
Packaging Quantity			2pcs
Storage Temperature Range			-55°C to +125°C
Storage Humidity			5% - 95% RH

The product information and specifications may be subject to changes even without prior written notice. The product has been designed for various applications; its suitability lies in the responsibility of each customer. The products are not authorized for use in safety-critical applications without RECOM's explicit written consent. A safety-critical application is an application where a failure may reasonably be expected to endanger or cause loss of life, inflict bodily harm or damage property. The applicant shall indemnify and hold harmless RECOM, its affiliated companies and its representatives against any damage claims in connection with the unauthorized use of RECOM products in such safety-critical applications.