

MDT5000	800 x 480	24-Bit RGB Interface	TFT Module
Specification			
Version: 1		Date: 14/05/2018	
Revision			
1	12/06/2016	First issue.	

Display Features						
Display Size	5.0"					
Resolution	800 x 480					
VGA Size	WVGA					
Orientation	Landscape					
Appearance	RGB					
Logic Voltage	3.3V					
Interface	24-Bit RGB					
Brightness	600 cd/m ²					
Touchscreen	N/A					
Module Size	120.70 x 75.90 x 3.00 mm					
Operating Temperature	-20°C ~ +70°C					
Pinout	40 - Way FFC	<table border="1"> <tr> <th>Box Quantity</th> <th>Weight / Display</th> </tr> <tr> <td>---</td> <td>---</td> </tr> </table>	Box Quantity	Weight / Display	---	---
Box Quantity	Weight / Display					
---	---					

* - For full design functionality, please use this specification in conjunction with the ILI5960 specification. (Provided Separately)

Display Accessories	
Part Number	Description
MPBV6	40 Way FFC to cable and wires. Driven by any driver board that can be wired to a 1mm pitch SHDR-40V-S-B receptacle.

Optional Variants	
Appearances	Voltage
Resistive Touch Panel Capacitive Touch Panel	



Contents

1. Record of Revision.....	3
2 .General Specifications.....	4
3 .Input/Output Terminals.....	5
4. Absolute Maximum Ratings.....	6
5 .Electrical Characteristics.....	6
6 .Interface Timing.....	7
7. Optical Characteristics.....	11
8 . Environmental / Reliability Tests.....	17
9. Mechanical Drawing.....	18
10.Packing.....	19
11. Precautions For Use of LCD modules.....	20

MIDAS

designs manufacture • supply



2 General Specifications

	Feature	Spec
Characteristics	Size	5.0inch
	Resolution	800(horizontal)*480(Vertical)
	Interface	RGB-24bit
	Connect type	Connector
	Color Depth	16.7M
	Technology type	a-Si
	Pixel pitch (mm)	0.045 x 0.135
	Pixel Configuration	R.G.B. Vertical Stripe
	Display Mode	Normally White
	LCD Driver IC	ILI5960+ILI6122
	Viewing Direction	12 O'clock
	Gray Scale Inversion Direction	6 O'clock
Mechanical	LCM (W x H x D) (mm)	120.7*75.9*3
	Active Area(mm)	108 x 64.80
	With /Without TSP	Without
	Weight (g)	TBD
	LED Numbers	18LEDs

Note 1: Viewing direction is following the data which measured by optics equipment.

Note 2: Requirements on Environmental Protection: RoHS

Note 3: LCM weight tolerance: +/- 5%



3 Input/Output Terminals

No.	Symbol	Description
1	VBL-	Backlight LED Cathode
2	VBL+	Backlight LED Anode.
3	GND	System Ground
4	VCC	Power supply for logic operation
5~12	R0~R7	Data bus
13~20	G0~G7	Data bus
21~28	B0~B7	Data bus
29	GND	System Ground
30	CLK	Pixel clock signal
31	DISP	Display on/off control
32	HSYNC	Horizontal Sync signal
33	VSYNC	Vertical Sync signal
34	DEN	Data Enable
35	NC	No connect
36	GND	System Ground
37	XR(NC)	The right side signal of TP
38	YD(NC)	The down side signal of TP
39	XL(NC)	The left side signal of TP
40	YU(NC)	The up side signal of TP



4 Absolute Maximum Ratings

(Note 1)

Item	Symbol	Values		Unit	Remark
		Min.	Max.		
Power voltage	DV_{DD}	-0.3	5	V	
	AV_{DD}	-0.5	13.5	V	
	V_{GH}	-0.3	42	V	
	V_{GL}	-20	0.3	V	
	$V_{GH}-V_{GL}$	-	40	V	
Operation Temperature	T_{OP}	-20	70	°C	
Storage Temperature	T_{ST}	-30	80	°C	
LED Reverse Voltage	V_R	-	3.3	V	Each LED Note 2
LED Forward Current	I_F	-	20	mA	Each LED

Note 1: The absolute maximum rating values of this product are not allowed to be exceeded at any times. A module should be used with any of the absolute maximum ratings exceeded, the characteristics of the module may not be recovered, or in an extreme condition, the module may be permanently destroyed.

Note 2: V_R Conditions: Zener Diode 20mA

5 Electrical Characteristics

5.1 Typical operation conditions

(Note 1)

Item	Symbol	Values			Unit	Remark
		Min.	Typ.	Max.		
Power voltage	DV _{DD}	3.0	3.3	3.6	V	Note 2
	AV _{DD}	10.2	10.4	10.6	V	
	V _{GH}	15.3	16.0	16.7	V	
	V _{GL}	-6.7	-6.0	-5.3	V	
Input signal voltage	V _{COM}	3.09	4.09	5.09	V	Note 4
Input logic high voltage	V _{IH}	0.7 DV _{DD}	-	DV _{DD}	V	Note 3
Input logic low voltage	V _{IL}	0	-	0.3 DV _{DD}	V	

Note 1: Be sure to apply DV_{DD} and V_{GL} to the LCD first, and then apply V_{GH}.

Note 2: DV_{DD} setting should match the signals output voltage (refer to Note 3) of customer's system board.

Note 3: DCLK, HS, VS, RESET, U/D, L/R, DE, R0~R7, G0~G7, B0~B7, MODE, DITHB.

Note 4: Typical V_{COM} is only a reference value. It must be optimized according to each LCM. Please use VR and base on below application circuit.

5.2 Current Consumption

Item	Symbol	Values			Unit	Remark
		Min.	Typ.	Max.		
Current for Driver	I _{GH}	-	(0.50)	1	mA	V _{GH} = 16.0V
	I _{GL}	-	(0.54)	1	mA	V _{GL} = -6.0V
	IDV _{DD}	-	(4.2)	10	mA	DV _{DD} = 3.3V
	I _{AV} _{DD}	-	(19)	50	mA	AV _{DD} = 10.4V

5.2 Driving Backlight

Item	Symbol	MIN	TYP	MAX	Unit	Remark
LED current	I_F	-	60	-	mA	Note 1 Note 2,3
Power Consumption			-	-	mW	
LED Voltage	V_F	-	19.2	-	V	
LED Life Time	W_{BL}	25000			Hr	

Note 1 : There are 2 Groups LED

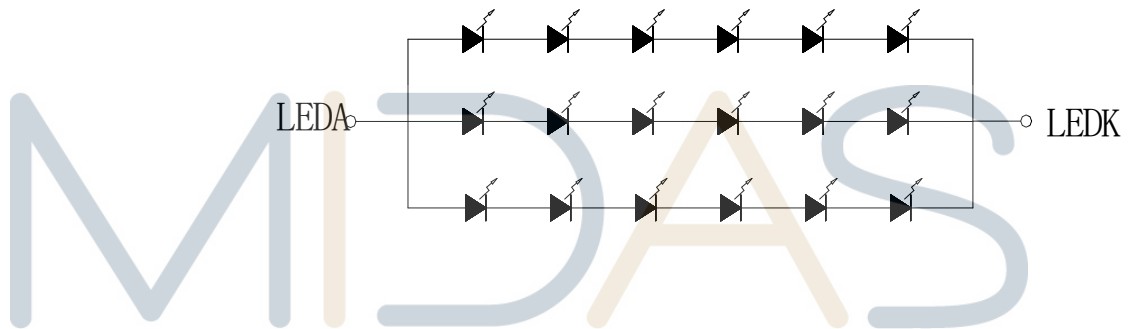

Note 2 : $T_a = 25^\circ\text{C}$

Note 3 : Brightness to be decreased to 50% of the initial value



6 Interface Timing

6.1 Power Sequence

To prevent a latch-up or DC operation of the LCD module, the power on/off sequence should be as the diagram below.

a. Power on sequence:

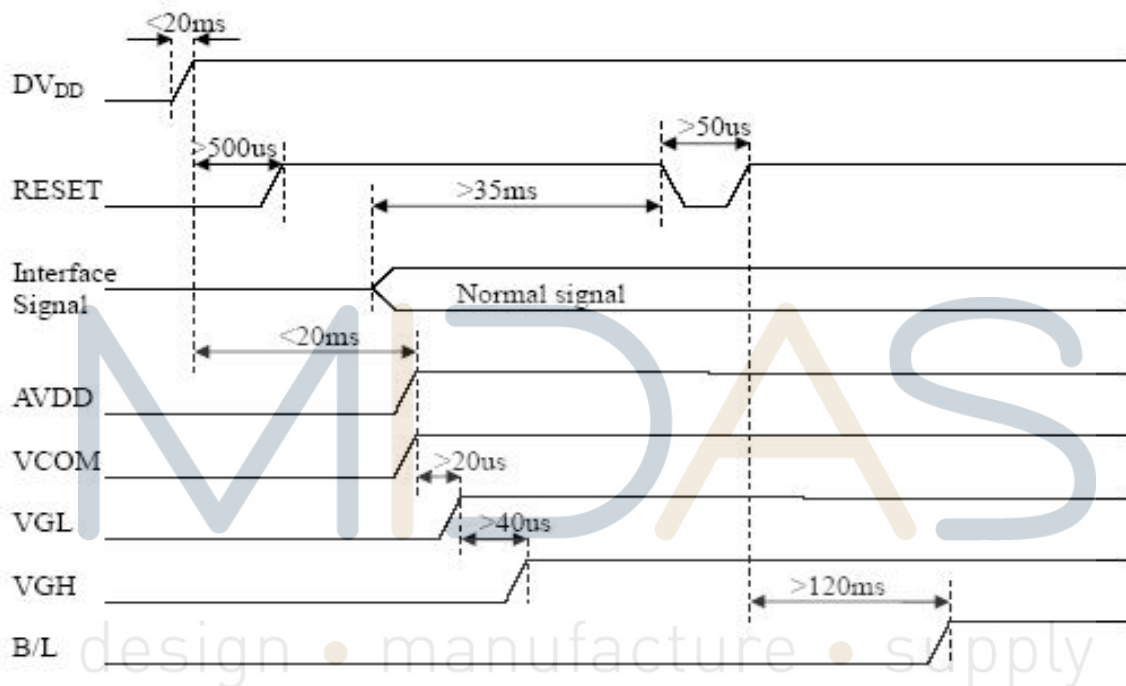

b. Power off sequence:

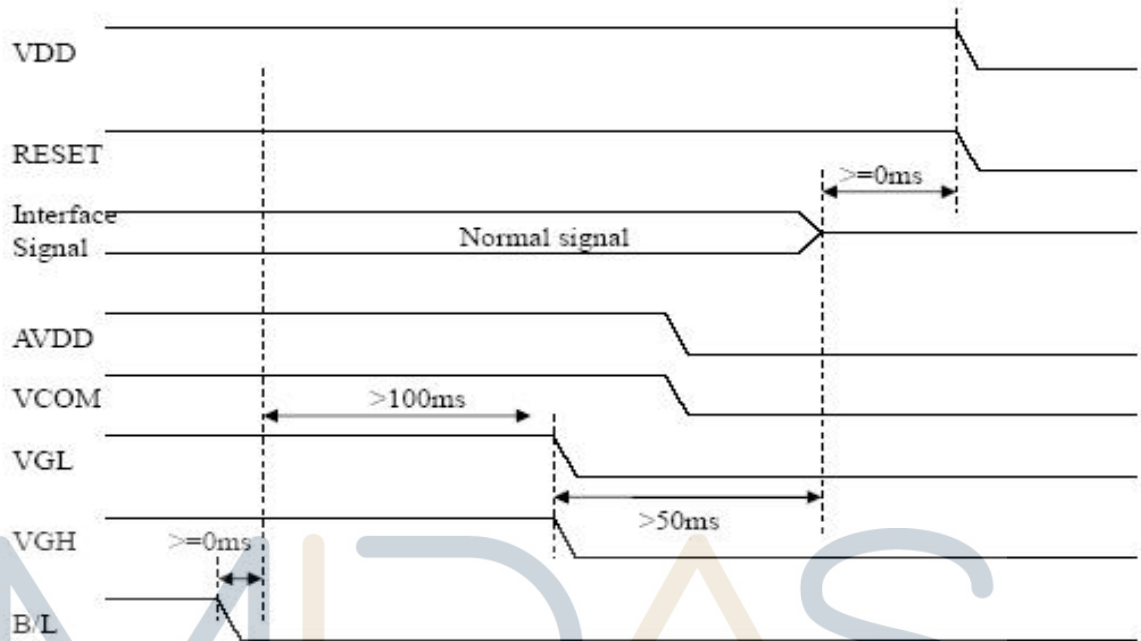

6.2 Timing Conditions

Item	Symbol	Values			Unit	Remark
		Min.	Typ.	Max.		
HS setup time	T_{hst}	8	-	-	ns	
HS hold time	T_{hhd}	8	-	-	ns	
VS setup time	T_{vst}	8	-	-	ns	
VS hold time	T_{vhd}	8	-	-	ns	
Data setup time	T_{dsu}	8	-	-	ns	
Data hole time	T_{dhd}	8	-	-	ns	
DE setup time	T_{esu}	8	-	-	ns	
DE hole time	T_{ehd}	8	-	-	ns	
DV _{DD} Power On Slew rate	T_{POR}	-	-	20	ms	From 0 to 90% DV _{DD}
RESET pulse width	T_{Rst}	1	-	-	ms	
DCLK cycle time	T_{coh}	20	-	-	ns	
DCLK pulse duty	T_{cwh}	40	50	60	%	

6.3 Timing Diagram

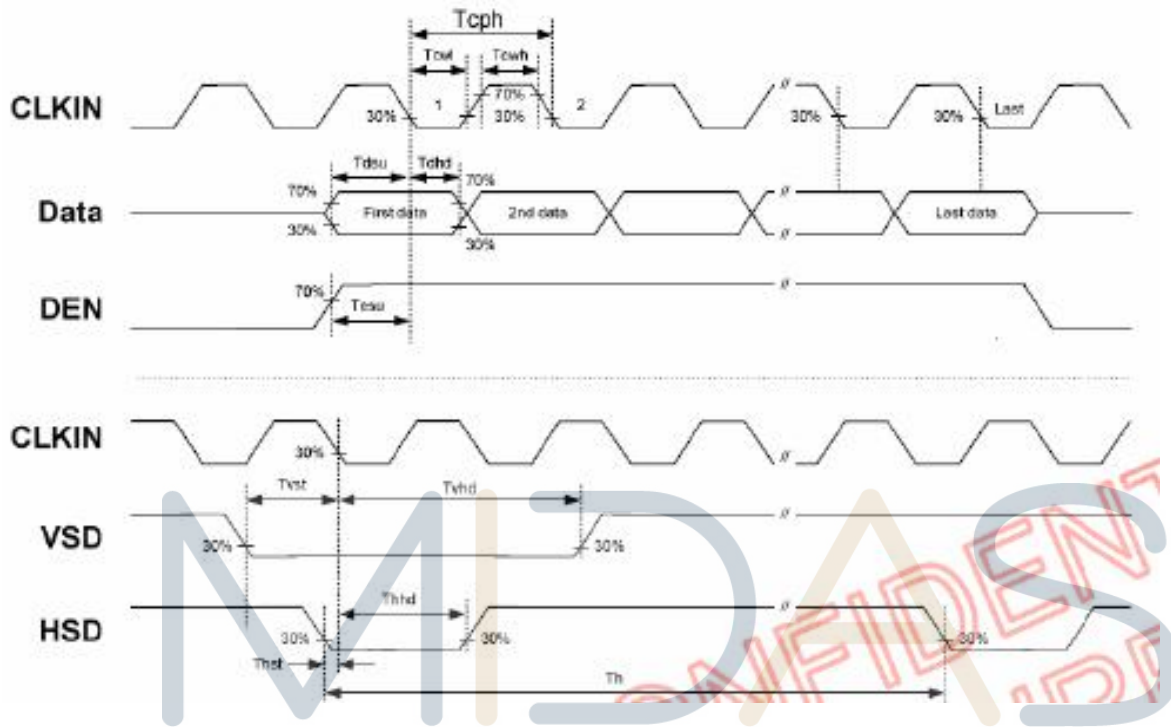

6.4 Timing

Item	Symbol	Values			Unit	Remark
		Min.	Typ.	Max.		
Horizontal Display Area	thd	-	800	-	DCLK	
DCLK Frequency	fclk	26.4	33.3	46.8	MHz	
One Horizontal Line	th	862	1056	1200	DCLK	
HS pulse width	thpw	1	-	40	DCLK	
HS Blanking	thb	46	46	46	DCLK	
HS Front Porch	thfp	16	210	354	DCLK	

Item	Symbol	Values			Unit	Remark
		Min.	Typ.	Max.		
Vertical Display Area	tvd	-	480	-	TH	
VS period time	tv	510	525	650	TH	
VS pulse width	tpw	1	-	20	TH	
VS Blanking	tvb	23	23	23	TH	
VS Front Porch	tvfp	7	22	147	TH	

6.5 Data Input Format



Figure 3. 1 Horizontal input timing diagram.

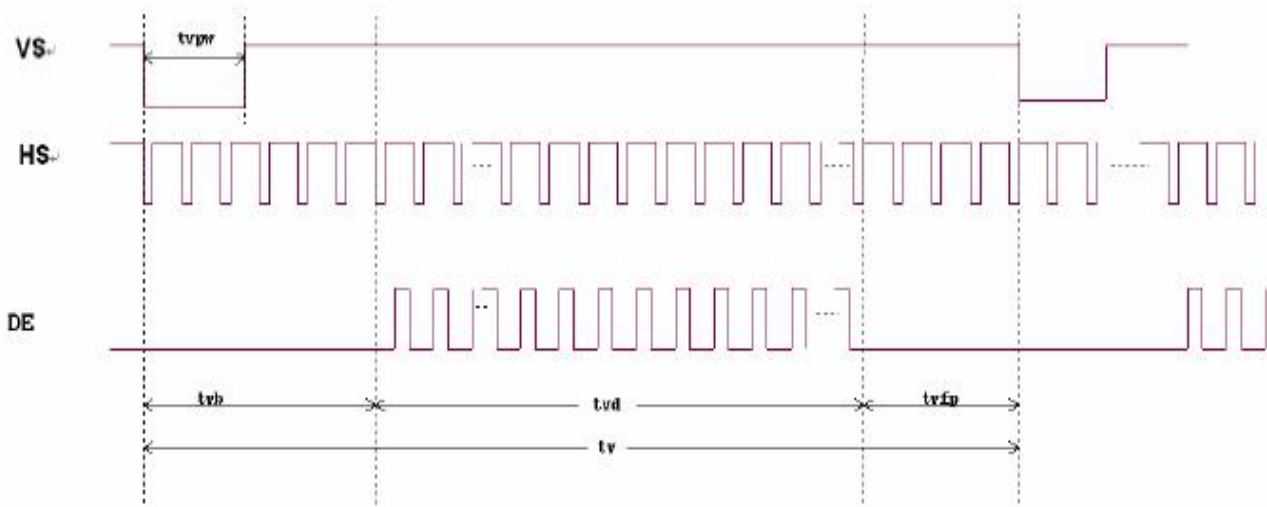
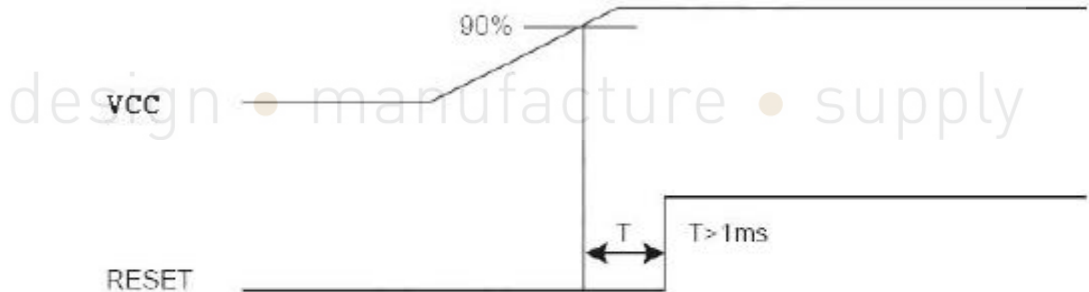

Figure 3. 2 Vertical input timing diagram.

The RESET input must be held at least 1ms after power is stable



Reset timing



7 Optical Characteristics

Items	Symbol	Condition	Min.	Typ.	Max.	Unit	Remark
Viewing angles	θ_T	Center CR \geq 10	40	50	-	Degree.	Note2
	θ_B		60	70	-		
	θ_L		60	70	-		
	θ_R		60	70	-		
Contrast Ratio	CR	$\Theta = 0$	500	600	-	-	Note1, Note3
Response Time	T _{ON}	25°C	-	20	30	ms	Note1, Note4
	T _{OFF}		-	20	30		
Chromaticity	White	X _W	0.324	0.326	0.328	-	Note1, Note5
		Y _W	0.364	0.366	0.368	-	
	Red	X _R	0.611	0.613	0.615	-	
		Y _R	0.333	0.335	0.337	-	
	Green	X _G	0.305	0.307	0.309	-	
		Y _G	0.558	0.560	0.562	-	
	Blue	X _B	0.133	0.135	0.137	-	
		Y _B	0.158	0.160	0.162	-	
Uniformity	U		80	-	-	%	Note1, Note6
NTSC				50		%	Note5
Luminance	L		-	600			Note1, Note7

Test Conditions:

1. IF= 20mA(one channel),the ambient temperature is 25°C.
2. The test systems refer to Note 1 and Note 2.

Note 1: Definition of optical measurement system.

The optical characteristics should be measured in dark room. After 5 minutes operation, the optical Properties are measured at the center point of the LCD screen. All input terminals LCD panel must be ground when measuring the center area of the panel.

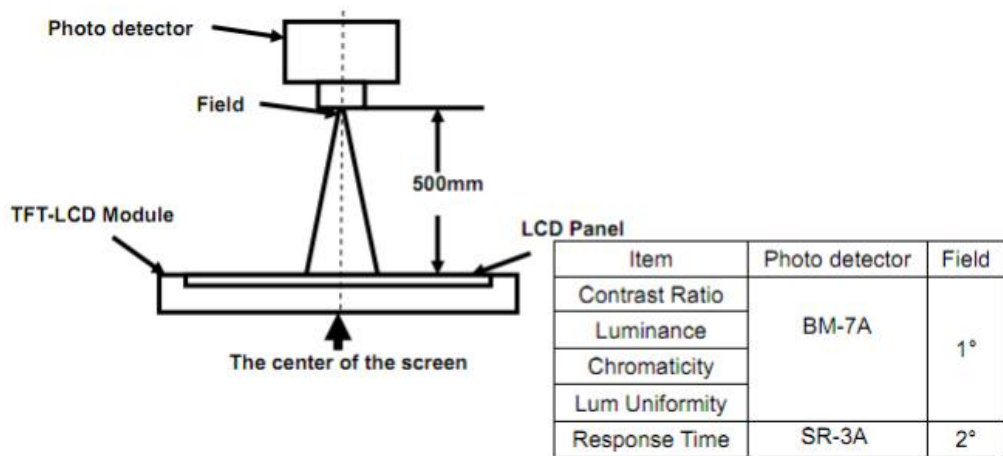

Note 2: Definition of viewing angle range and measurement system.

Viewing angle is measured at the center point of the LCD by CONOSCOPE (ergo-80).

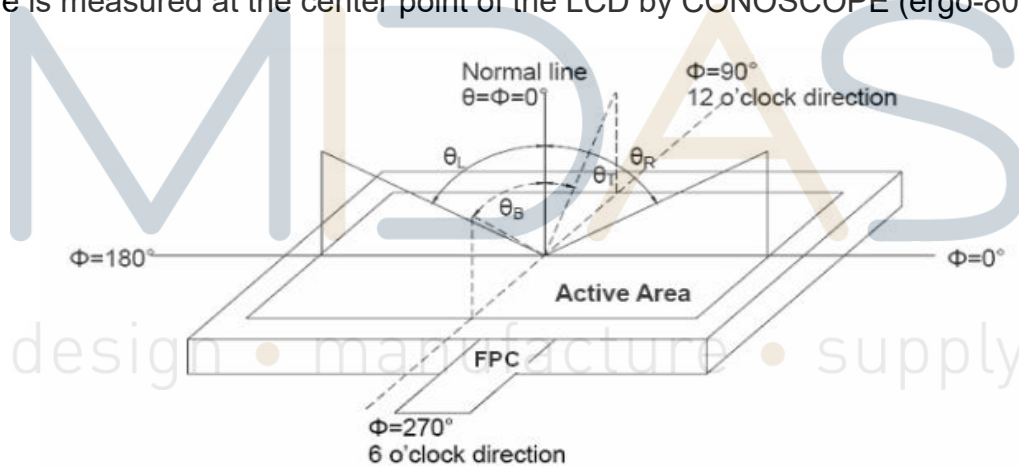

Fig. 1 Definition of viewing angle

Note 3: Definition of contrast ratio

$$\text{Contrast ratio (CR)} = \frac{\text{Luminance measured when LCD is on the "White" state}}{\text{Luminance measured when LCD is on the "Black" state}}$$

Note 4: Definition of Response time

The response time is defined as the LCD optical switching time interval

Between "White" state and "Black" state. Rise time (TON) is the time between

Photo detector output intensity changed from 90% to 10%. And fall time (TOFF) is

The time between photo detector output intensity changed from 10% to 90%

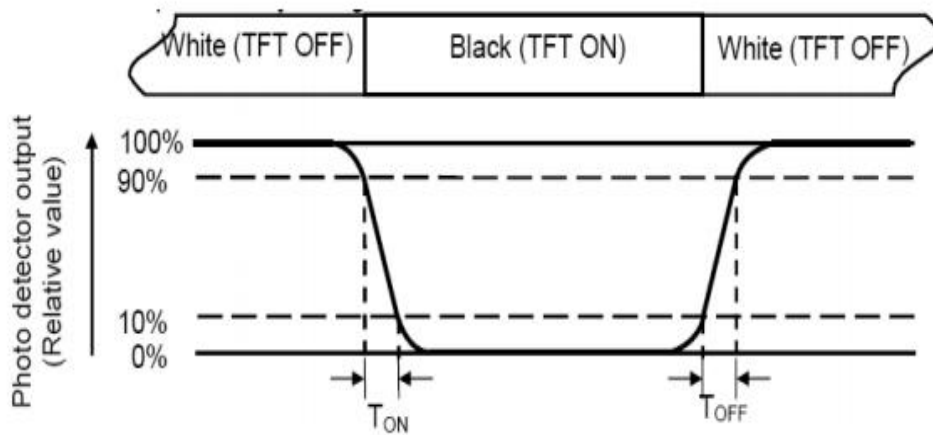

Note 5: Definition of color chromaticity (CIE1931)

Color coordinates measured at center point of LCD.

Note 6: Definition of Luminance Uniformity

Active area is divided into 9 measuring areas (Refer Fig. 2). Every measuring point is placed at the Center of each measuring area

Luminance Uniformity (U) = $L_{min} / L_{max} \times 100\%$

L-----Active area length W----- Active area width

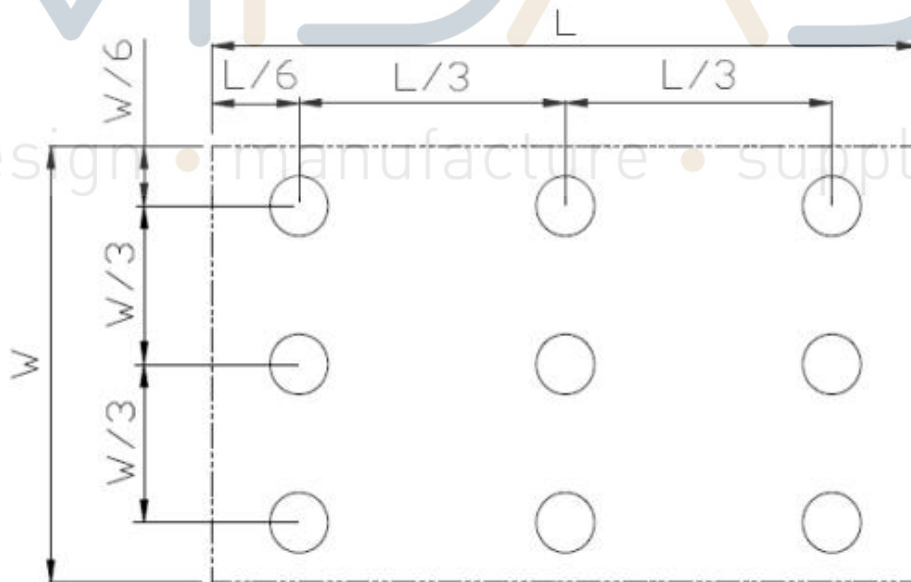

Fig. 2 Definition of uniformity

L_{max} : The measured maximum luminance of all measurement position.

L_{min} : The measured minimum luminance of all measurement position.

Note 7: Definition of Luminance:

Measure the luminance of white state at center point.

8 Environmental / Reliability Tests



No	Test Item	Condition	Remarks
1	High Temperature Operation	T _s = +70°C, 240hrs	Note 1 IEC60068-2-2, GB2423. 2-89
2	Low Temperature Operation	T _a = -20°C, 240hrs	Note 2 IEC60068-2-1 GB2423.1-89
3	High Temperature Storage	T _a = +80°C, 240hrs	IEC60068-2-2 GB2423. 2-89
4	Low Temperature Storage	T _a = -30°C, 240hrs	IEC60068-2-1 GB/T2423.1-89
5	High Temperature & Humidity Storage	T _a = +60°C, 90% RH max, 160 hours	IEC60068-2-3 GB/T2423.3-2006
6	Thermal Shock (Non-operation)	-30°C 30 min ~ +80°C 30 min Change time: 5min, 30 Cycle	Start with cold temperature, end with high temperature IEC60068-2-14, GB2423.22-87
7	Electro Discharge (Operation) Static	C=150pF, R=330 Ω, 5 points/panel Air:±8KV, 5 times; Contact: ±4KV, 5 times; (Environment: 15°C ~ 35°C, 30% ~ 60%, 86Kpa ~ 106Kpa)	IEC61000-4-2 GB/T17626.2-1998
8	Vibration (Non-operation)	Frequency range: 10~55Hz, Stroke: 1.mm Sweep: 10Hz~55Hz~10Hz 2 hours for each direction of X .Y. Z. (package condition)	IEC60068-2-6 GB/T2423.5-1995
9	Shock (Non-operation)	60G 6ms, ± X, ±Y , ± Z 3 times for each direction	IEC60068-2-27 GB/T2423.5-1995
10	Package Drop Test	Height: 60 cm, 1 corner, 3 edges, 6 surfaces	IEC60068-2-32 GB/T2423.8-1995

Note: 1. T_s is the temperature of panel's surface.
2. T_a is the ambient temperature of sample.



9 . Mechanical Drawing

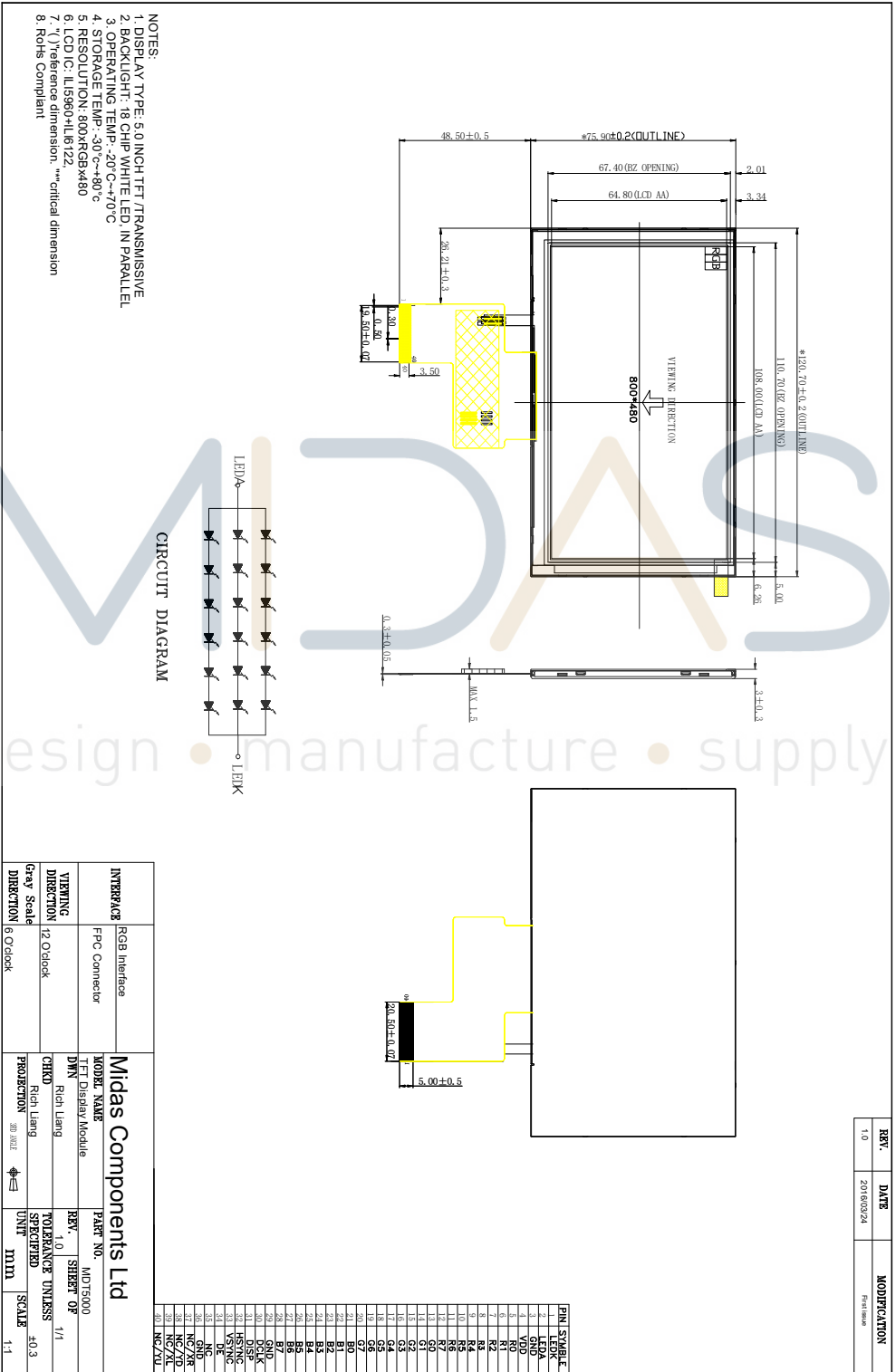

REV.	DATE	MODIFICATION
1.0	2016/03/24	Final Issue

1 0.Packing

Packing Method

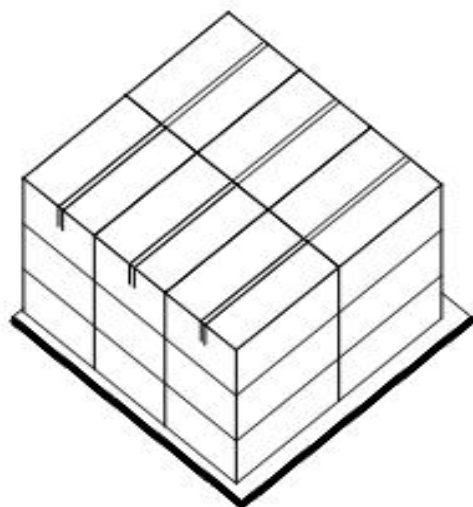
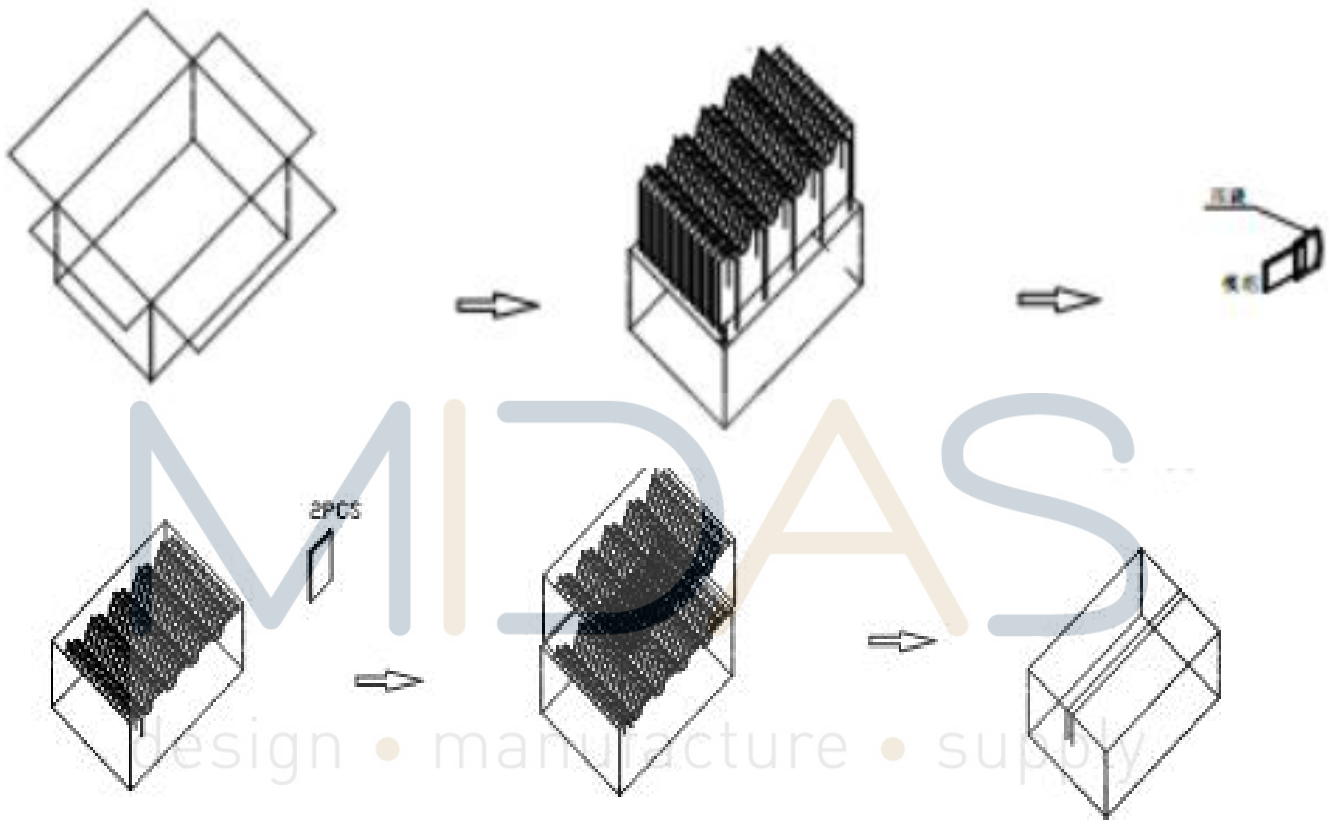

11. Precautions for Use of LCD modules

11.1 Handling Precautions

11.1.1. The display panel is made of glass. Do not subject it to a mechanical shock by dropping it from a high place, etc.

11.1.2. If the display panel is damaged and the liquid crystal substance inside it leaks out, be sure not to get any in your mouth, if the substance comes into contact with your skin or clothes, promptly wash it off using soap and water.

11.1.3. Do not apply excessive force to the display surface or the adjoining areas since this may cause the color tone to vary.

11.1.4. The polarizer covering the display surface of the LCD module is soft and easily scratched. Handle this polarizer carefully.

11.1.5. If the display surface is contaminated, breathe on the surface and gently wipe it with a soft dry cloth. If still not completely clear, moisten cloth with one of the following solvents:

- Isopropyl alcohol
- Ethyl alcohol

Solvents other than those mentioned above may damage the polarizer. Especially, do not use the following:
Water ; Ketene ; Aromatic solvents

11.1.6. Do not attempt to disassemble the LCD Module.

11.1.7. If the logic circuit power is off, do not apply the input signals.

11.1.8. To prevent destruction of the elements by static electricity, be careful to maintain an optimum work environment.

11.1.8.1. Be sure to ground the body when handling the LCD Modules.

11.1.8.2. Tools required for assembly, such as soldering irons, must be properly ground.

11.1.8.3. To reduce the amount of static electricity generated, do not conduct assembly and other work under dry conditions.

11.1.8.4. The LCD Module is coated with a film to protect the display surface. Be care when peeling off this protective film since static electricity may be generated.

11.2 Storage Precautions

11.2.1. When storing the LCD modules, avoid exposure to direct sunlight or to the light of fluorescent lamps.

11.2.2. The LCD modules should be stored under the storage temperature range. If the LCD modules will be stored for a long time, the recommend condition is:

Temperature : 0°C ~ 40°C Relatively humidity: ≤80%

11.2.3. The LCD modules should be stored in the room without acid, alkali and harmful gas.

11.3 Transportation Precautions

The LCD modules should be no falling and violent shocking during transportation, and also should avoid excessive press, water, damp and sunshine.

