

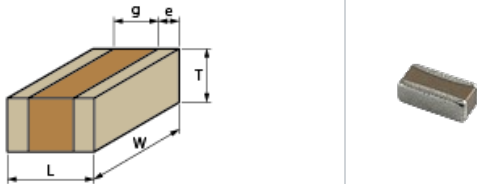

< List of part numbers with package codes >
 LLL185C70G225ME01L , LLL185C70G225ME01K

Shape



L size	0.8 ±0.1mm
W size	1.6 ±0.1mm
T size	0.5 +0.05/-0.1mm
External terminal width e	0.25±0.15mm
Distance between external terminals g	0.1mm min.
Size code in inch(mm)	0306 (0816M)

References

Packaging	Specifications	Minimum quantity
L	φ180mm Embossed taping	4000
K	φ330mm Embossed taping	10000

Mass (typ.)	
1 piece	3.9mg
φ180mm Reel	100g

Specifications

Capacitance	2.2μF ±20%
Rated voltage	4Vdc
Temperature characteristics (complied standard)	X7S(EIA)
Capacitance change rate	±22.0%
Temperature range of temperature characteristics	-55 to 125°C
Operating temperature range	-55 to 125°C

Attention

- 1.This datasheet is downloaded from the website of Murata Manufacturing Co., Ltd. Therefore, it's specifications are subject to change or our products in it may be discontinued without advance notice. Please check with our sales representatives or product engineers before ordering.
- 2.This datasheet has only typical specifications because there is no space for detailed specifications. Therefore, please review our product specifications or consult the approval sheet for product specifications before ordering.

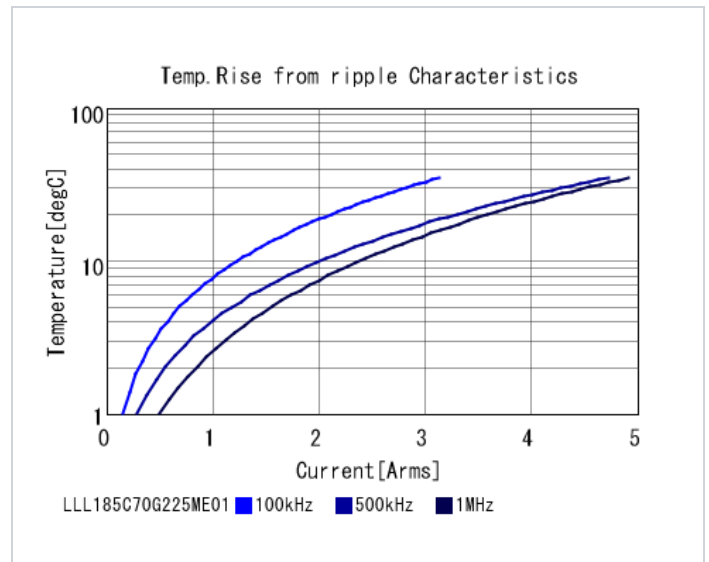
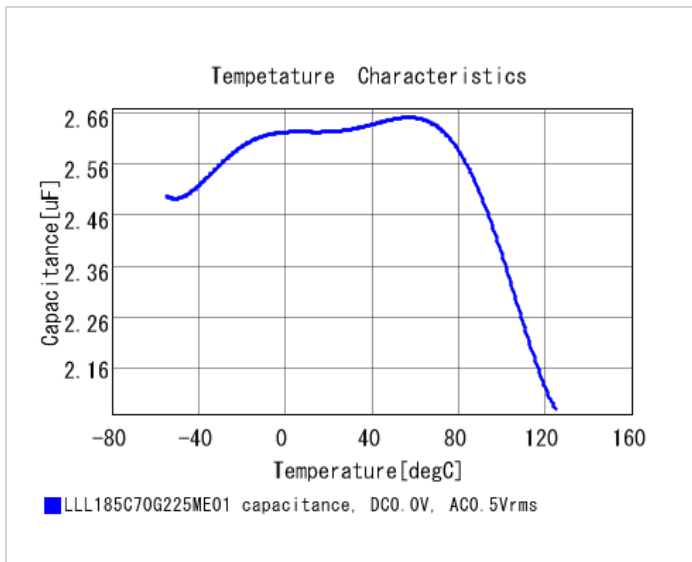
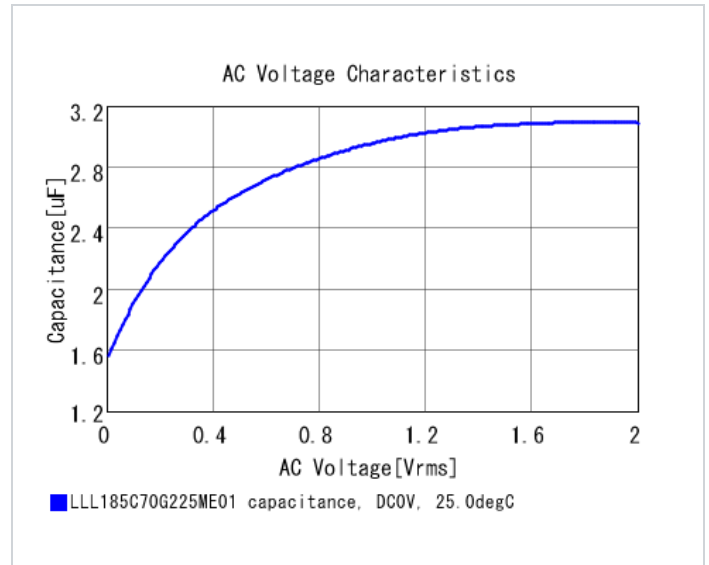
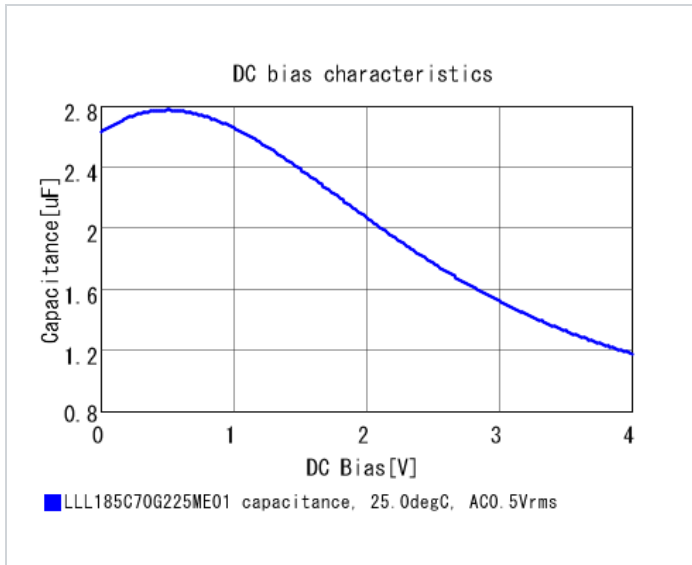
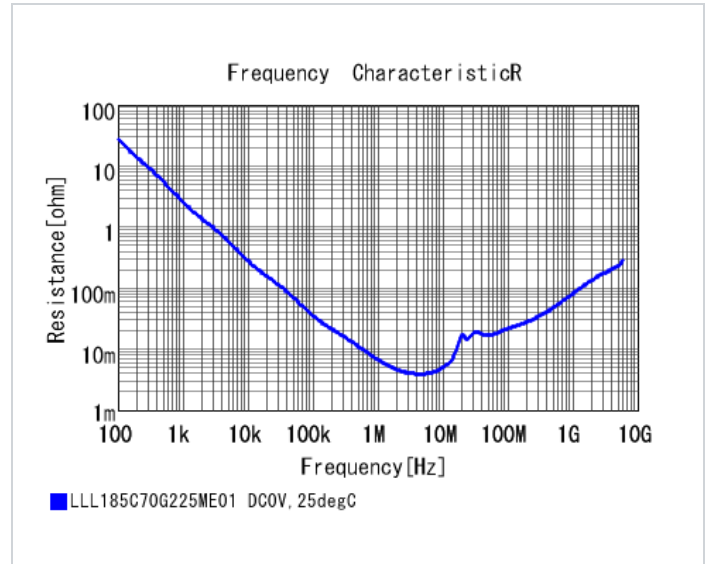
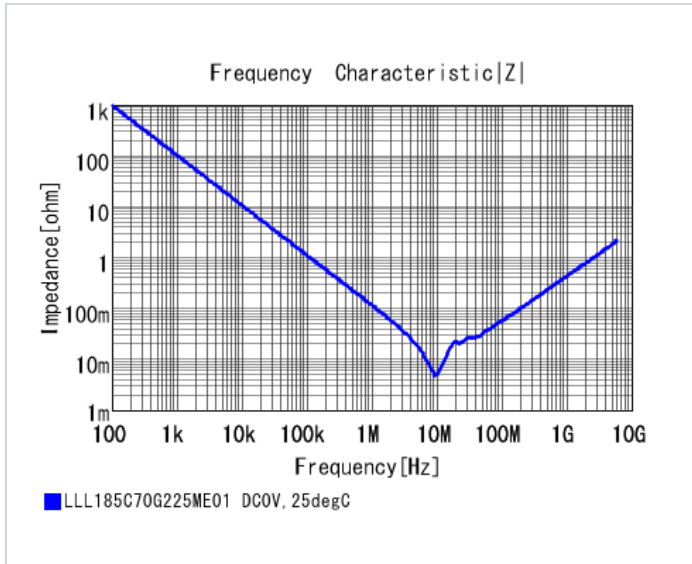

⚠ Attention

- 1.This datasheet is downloaded from the website of Murata Manufacturing Co., Ltd. Therefore, it's specifications are subject to change or our products in it may be discontinued without advance notice. Please check with our sales representatives or product engineers before ordering.
- 2.This datasheet has only typical specifications because there is no space for detailed specifications. Therefore, please review our product specifications or consult the approval sheet for product specifications before ordering.