

LED/LCD TVS (66.04cm - 139.7cm)

# 26"-55"

## 80 lbs. / 36 kg



UL Rated for up to 80lbs. / 36.2kg

### Parts List

NOTE: Not all hardware included will be used.

(1) Wall Bracket

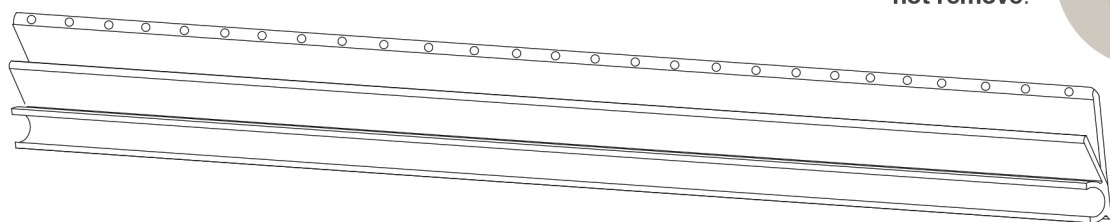

(1) TV Mounting Bracket

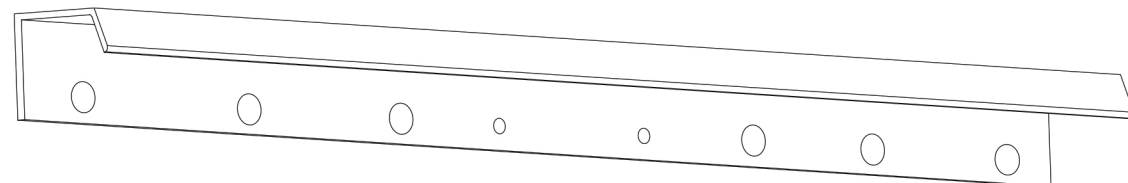

(1) Security Cable



NOTE: Wall bracket includes foam backing to protect your wall, **do not remove.**

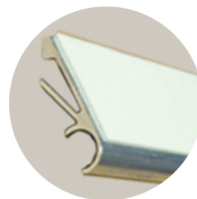

(1) Level



(20) Nails



(6) Bolt Washers



(2) Small Washers for 4mm bolts



(2) M8 (8mm) x 35mm bolts

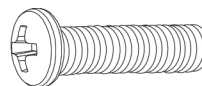

(2) M8 (8mm) x 20mm bolts

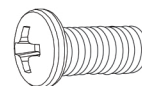

(2) M8 (8mm) x 16mm bolts



(2) M6 (6mm) x 35mm bolts

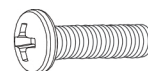

(2) M6 (6mm) x 20mm bolts

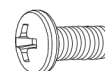

(2) M6 (6mm) x 12mm bolts



(2) M5 (5mm) x 35mm bolts

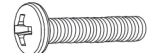

(2) M5 (5mm) x 12mm bolts



(2) M4 (4mm) x 35mm bolts

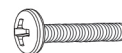

(2) M4 (4mm) x 12mm bolts



(1) 1-1/2" Bear Claw Security Cable Screw



**CAUTION:** This S2040-A mount is intended for use only with LED displays weighing up to 80lbs. Use with products heavier than 80lbs may result in collapse of the mount and its accessories causing possible injury.



**WARNING:** Before starting assembly, verify all parts are included and undamaged. If any parts are missing or damaged, do not return to your dealer; contact Customer Service. Never use damaged parts!



**WARNING:** **CHOKING HAZARD** — Small parts not for children under 3 years or any individuals who have a tendency to place inedible objects in their mouths.

# HANGMAN NO STUD TV HANGER®

## Installation Instructions



### Only Tools Required



Hammer



Phillips Screwdriver



FOR VIDEO INSTRUCTIONS

Scan QR or go to:  
[hangmanproducts.com/videos](http://hangmanproducts.com/videos)



685 Cochran St. #180-A  
Simi Valley, CA 93065



Customer Service  
Monday-Friday

818-610-0487  
7am-6pm PST

Se Habla Español



[info@hangmanproducts.com](mailto:info@hangmanproducts.com)



[hangmanproducts.com](http://hangmanproducts.com)

## For Installation in Drywall

For other wall types please use our [Simple Mount TV Hanger \(S2060-SF\)](#).

### STEP 1: INSTALL TV MOUNTING BRACKET

Place the TV face down on a soft surface where it is secure and stable. If your TV is already attached to a base, it must be removed before beginning the installation. The VESA holes on the back of the TV are either 4mm, 5mm, 6mm, 8mm depending on the brand of the TV. This kit includes all sizes.

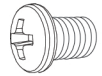

Note: It is very important to select the correct bolt diameter and length.



**IMPORTANT**



TOO SHORT



TOO LONG

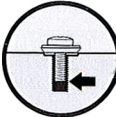

CORRECT

USE WASHERS IF BOLTS ARE TOO LONG

Attach TV mounting bracket to the top 2 holes using the appropriate bolts. This kit also includes different lengths of each size. Hand tighten to choose appropriate length then use a handheld Phillips screwdriver and tighten until snug.

**Do not overtighten.**

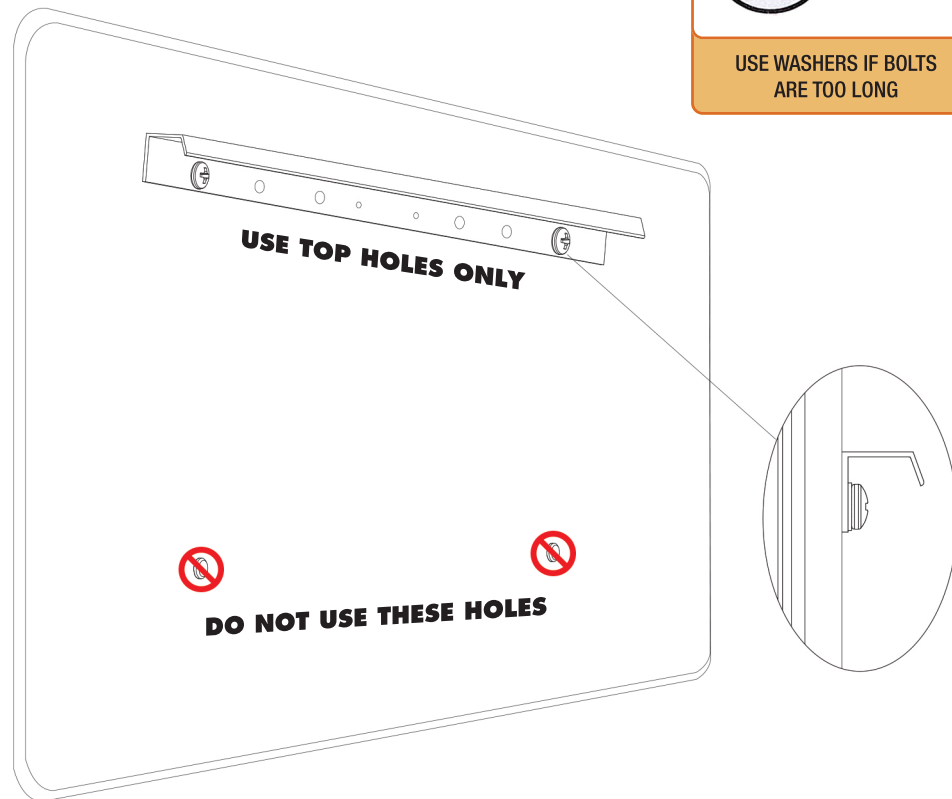

### STEP 2: INSTALL WALL BRACKET

Hold the wall bracket in place and install center nail first. This will allow you to easily adjust the bracket rotation. Insert level into slot and make sure it is level before installing the remaining nails.

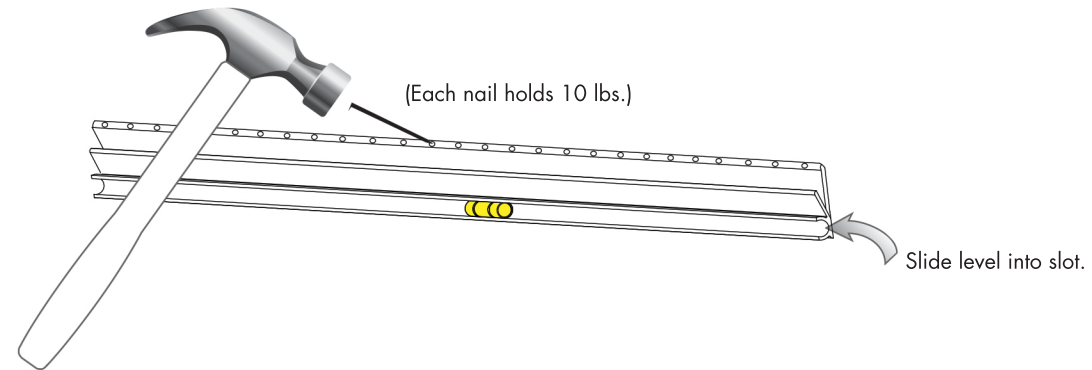

### STEP 3: HANG TV AND INSTALL SECURITY CABLE

Hang TV by engaging the TV bracket on top of the wall bracket, assuring the brackets have engaged correctly. (See below)

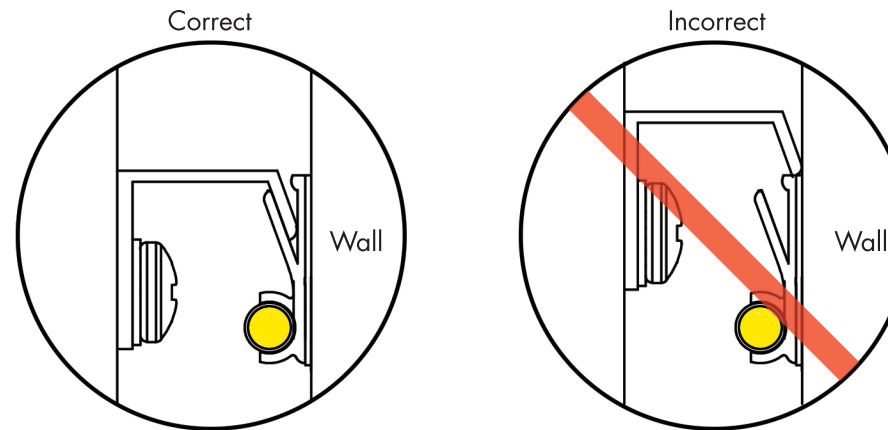

TV can be tilted away from wall for cable access.

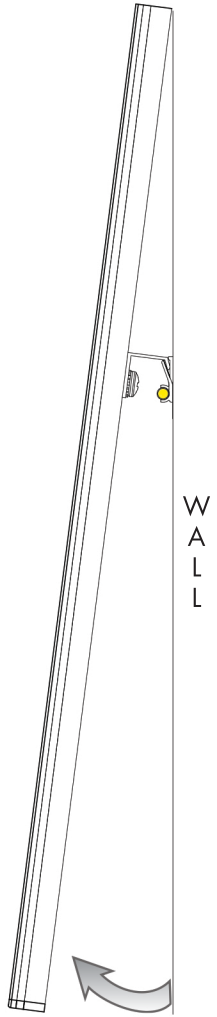

## Security Cable Installation

Insert Cable through the slot on the bracket. Hang TV and insert BearClaw security screw through the eyelet and into the wall.

