

KEMET, SSR21NV-M/NH-M, AC Line Filters, Common Mode, 0.12 H

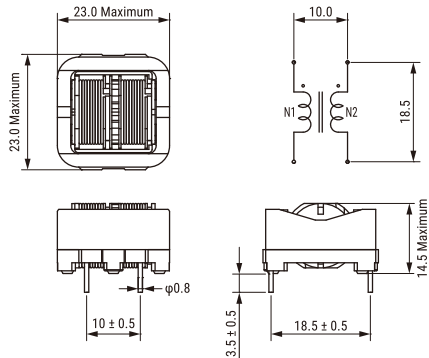

Dimensions	
L	23mm MAX
T	23mm MAX
H	14.5mm MAX
LL	3.5mm +/-0.5mm
S	18.5mm +/-0.5mm

Packaging Specifications	
Packaging:	Tray
Packaging Quantity:	420
Weight:	13 g

General Information	
Series:	SSR21NV-M/NH-M
Style:	Through-Hole
Features:	High Performance, High Impedance, Strong Inductance
RoHS:	Yes
Miscellaneous:	65 (K) Temperature Rise Max.

Specifications	
Voltage AC:	250 VAC
Inductance:	120 mH (10 kHz)
Current:	600 mA
Temperature Range:	-25/+120C
DC Resistance:	1.5 Ohms