



APPLICATION & ASSEMBLY INSTRUCTION

NAC3FX-W-TOP | powerCON® TRUE1 TOP

A. APPLICATION INSTRUCTION

Application:

The powerCON TRUE1 system is certified as a connector with breaking capacity according IEC 60320, VDE 0625. It is intended for use as an appliance coupler and interconnection coupler. It serves to supply power to an appliance and from an appliance to other equipment. To be installed by qualified person only.

CONNECTOR ASSIGNMENT:

APPLIANCE INLET

NAC3MPX-TOP
NAC3MPX-WOT-TOP
Power IN ▶



APPLIANCE OUTLET

NAC3FPX-TOP
NAC3FPX-WOT-TOP
NAC3FPX-ST-TOP
Power OUT ◀

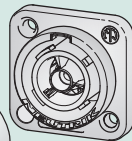

APPLIANCE INLET / OUTLET ▶ Combination

NAC3PX-TOP
Power IN ▶

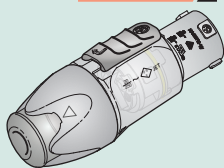
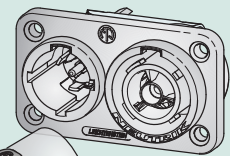

NAC3FX-W-TOP
(Connector)

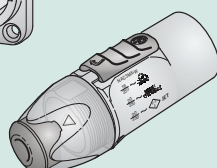

NAC3MX-W-TOP
(Plug connector)

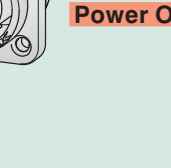

NAC3FX-W-TOP
(Connector)

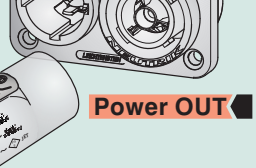
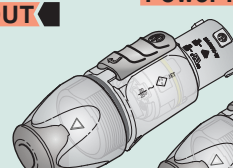

NAC3MX-W-TOP
(Plug connector)

Power OUT ◀

powerCON TRUE1 TOP line is full backward compatible with the preceding powerCON TRUE1 products.

Approval based:

VDE

EN 60320-1/EN60320-2-2



UL

UL 498 / CSA C22.2 No. 182.3



Rating:

250 V ac / 16 A

250 V ac / 20 A

Cable Type:

H05VV-F3G 1.0 mm², Length max. 2 m
H05VV-F3G 1.5 - 2.5 mm²
H07RN-F3G 1.5 mm²

SJTOW, SJOOW 3 x 12 AWG

Strain Relief:

White chuck

White chuck

Cable O.D.:

6.0 - 12.0 mm

6.0 - 12.0 mm

UL50E environmental rating

Enclosure Type 4 when mated with attachment plug NAC3MX-W-TOP or mated with appliance inlet NAC3MPX*-TOP with sealing cover SCNAC-MPX and NAC3PX-TOP with sealing cover SCNAC-PX.

B. ASSEMBLY INSTRUCTION

- A** Insert cable into the bushing and housing.

Note: "Apply cable pulling lubricant to cable jacket."

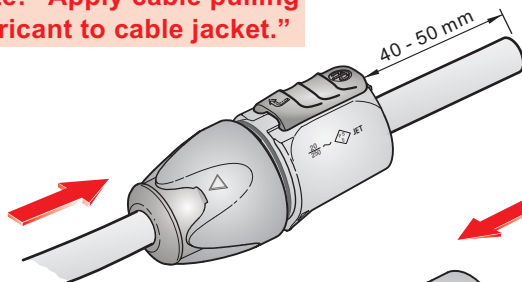

- B** Separate the housing from the bushing (cable remain in bushing)

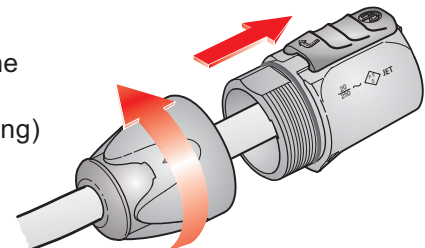

- C** Place chuck over the cable.

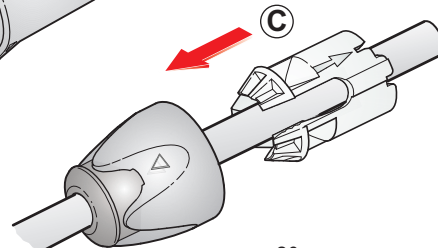

- D** Prepare cable as shown.

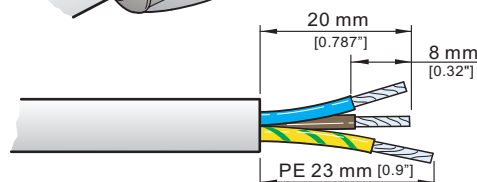

VDE (EN 60320-1/EN60320-2-2)

- i Recommendation:**
Wire Pulling Lubricant - LUB-I/0.95 from 3M™

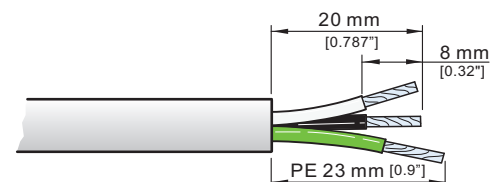

UL (UL 498 / CSA C22.2 No. 182.3)

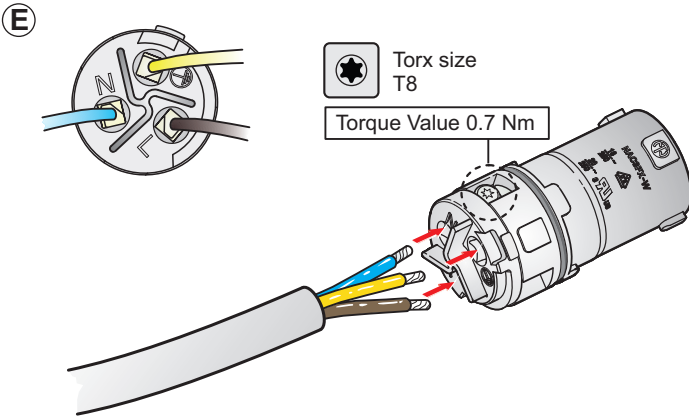

Slide the cable into the contacts and clamp with the screw with Torx size T8.

Wiring	VDE	UL
L ⇒	brown	black
N ⇒	blue	white
⊥ ⇒	green/yellow	green

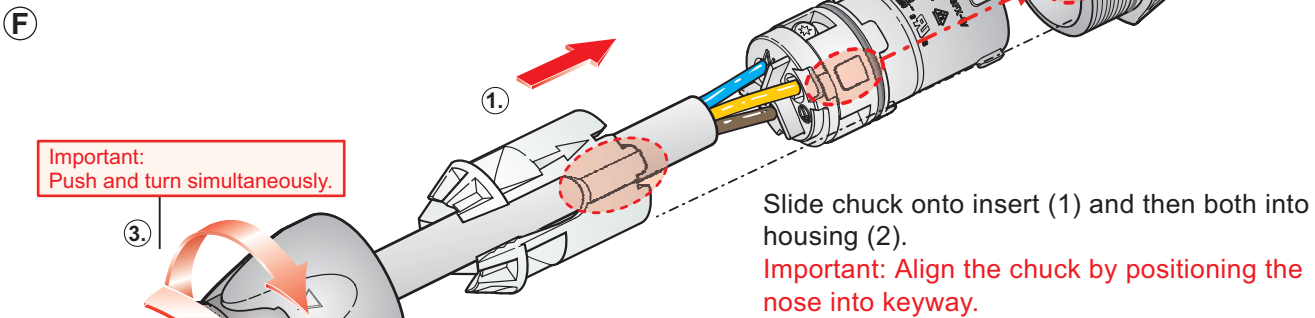

Slide chuck onto insert (1) and then both into housing (2).
Important: Align the chuck by positioning the nose into keyway.

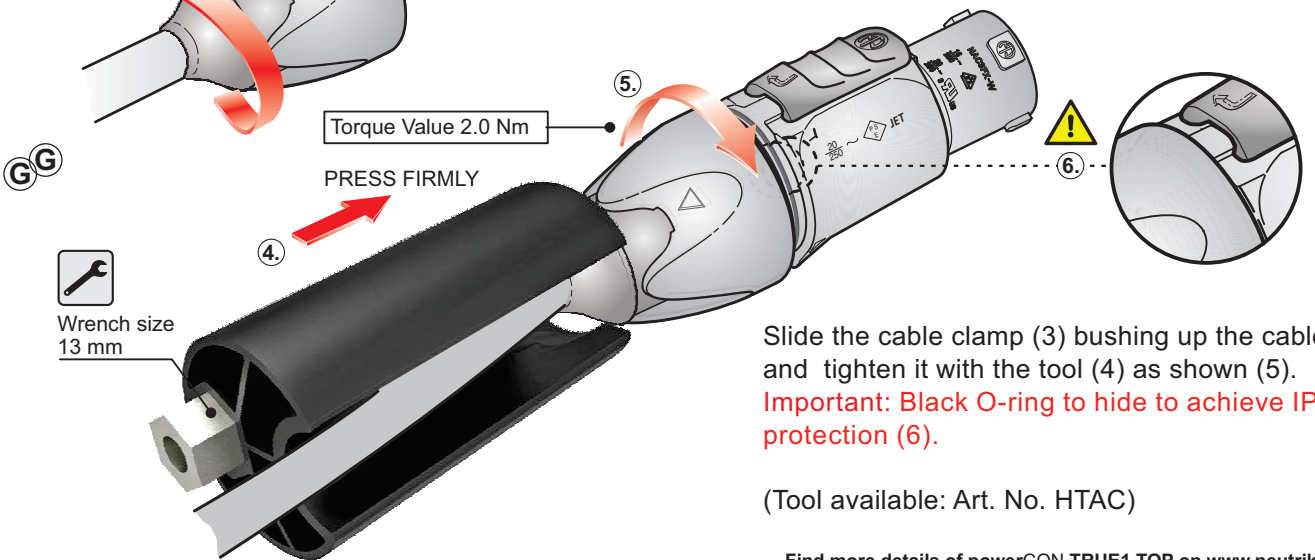

Slide the cable clamp (3) bushing up the cable and tighten it with the tool (4) as shown (5).
Important: Black O-ring to hide to achieve IP protection (6).

(Tool available: Art. No. HTAC)

Find more details of powerCON TRUE1 TOP on www.neutrik.com.

FOR DISASSEMBLY - OPEN TWIST LOCK!

- Press with screw driver to unlock
- Turn bushing 360°.
- Repeat step ①+② until bushing is unscrewed.

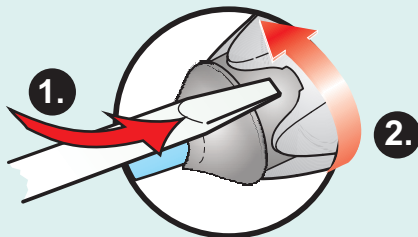

CAUTION

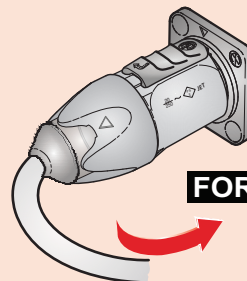

To ensure protection category, do not expose the connection to bending forces (e.g. do not attach loads to the cable, no free-dangling cable windings etc.).



SAFETY WARNING

For safety and certification reasons the connector must be replaced in case of any broken parts or excessive wear and tear.

Neutrik AG LI T: +423 / 237 24 24 F: +423/232 53 93
 Neutrik USA Inc. USA T: +1 704 / 972 3050 F: +1 704/438 9202
 Neutrik (UK) Ltd. UK T: +44 1983 / 811 441 F: +44 1983/811 439
 Neutrik Vertriebs GmbH DE/NL/AT/DK T: +49 8131 / 280 890 F: +49 8131/280 830

Neutrik France FR T: +33 1/4131 6750 F: +33 1/4131 0511
 Neutrik Tokyo Ltd. JP T: +81 3/3663 4733 F: +81 3/3663 4796
 Neutrik Hong Kong Ltd. HK T: +852/2687 6055 F: +852/2687 6052
 Neutrik India Pvt. Ltd. IND T: +91/982 05 43 424 F: +91/22 26163 540