

MAX77860 Evaluation System

Evaluates: MAX77860

General Description

The MAX77860 evaluation system (EV system) is a fully assembled and tested surface-mount printed circuit board (PCB) that evaluates the single input switched-mode battery charger featuring USB Type-C CC detection and charging capability in addition to reverse boost capability and a safeout LDO.

The MAX77860 EV system includes the integrated circuit (IC) evaluation board with an integrated I²C interface and a MINIQUSB communication device. Windows[®] based graphical user interface (GUI) software is available for use with the EV system and can be downloaded from the MAX77860 product page on the Maxim website. A Windows 7 or newer operating system is required to use the EV kit GUI software.

Features

- Evaluates MAX77860 Single-Input Switch Mode Charger
- Demonstrates 4.0V to 13.5V Input Operation Range
- Demonstrates USB Type-C Charging Up to 3.15A
- Demonstrates Adapter Detection
- Demonstrates USB-OTG Functionality
- Assembled and Tested
- I²C Serial Interface

[Ordering Information](#) appears at end of data sheet.

MAX77860 EV System Files

FILE	DESCRIPTION
MAX77860GUISetupx.x.x.exe	Installs EV kit files on PC

MAX77860 EV System Component List

PART	QTY	DESCRIPTION
MAX77860EVKIT	1	MAX77860 evaluation kit
MAXIM MINIQUSB	1	MINIQUSB interface board
USB HIGH-SPEED A-TO-B CABLES 6FT	1	MINIQUSB cable

Windows is a registered is a registered trademark and service mark of Microsoft Corporation.

Quick Start

Required Equipment

- MAX77860 EV kit
- Single-cell Lithium-ion (Li-ion) battery pack
- Charging wall adapter or DC power supply capable of supplying 15.0V/3A
- Standard USB Type A to Type B cable (included in the EV system)
- PC running Windows 7 or above

Setup Overview

A typical bench setup for the MAX77860 EV system is shown in [Figure 1](#).

Procedure

Note: Do not turn on the DC power supplies until all connections are made.

- 1) Carefully connect the boards by inserting the 20-pin female connector of the MAX77860 EV system with the 20-pin male header of the MINIQUSB interface board. The two boards should be flush with each other.

- 2) Use the USB cable provided in the EV system to connect the MINIQUSB interface board to the PC's USB port.
- 3) Install the MAX77860 graphical user interface (GUI) from the MAX77860 product page on the Maxim website.
- 4) Verify whether the jumper settings follow the default configuration See [Jumper Settings](#) section.
- 5) Connect a Li-ion battery to the pads labeled BATT and BATTGND.
- 6) Connect a USB wall adapter to the USB Type C port on the board.
- 7) Launch the MAX77860 GUI software.
- 8) Select **Device > Connect** from the window options to connect to the EV system.

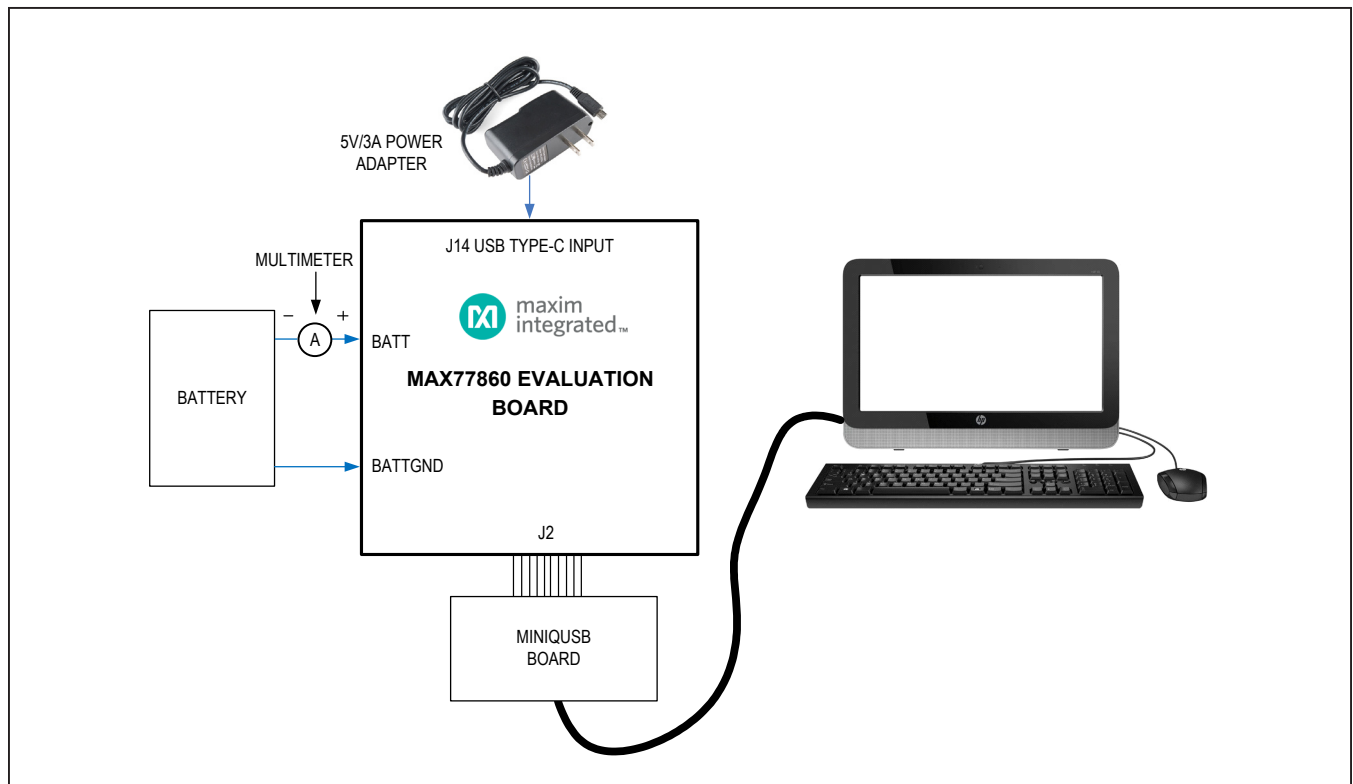

Figure 1. MAX77860 Bench Setup

Detailed Description of Software

The MAX77860 GUI software provides an easy-to-use interface to control the function blocks of the IC.

Software Installation

The software requires Windows 7 or newer operating system. .NET 4.5 is required for operation and is automatically installed if an older version of .NET is detected. To install the evaluation software, exit all programs currently running and unzip the provided MAX77860 GUI setup zipped file.

Double click the **MAX77860GUISetupx.x.xx.exe** icon to begin the installation process. Follow the prompts to complete the installation. The evaluation software can be uninstalled in the **Add/Remove Programs** tool in the **Control Panel**. After the installation is complete, open the **Maxim Integrated/MAX77860** folder and run **MAX77860.exe** or select **MAX77860** from the program menu. A splash screen containing information about the evaluation kit appears as the program is being loaded ([Figure 2](#)).

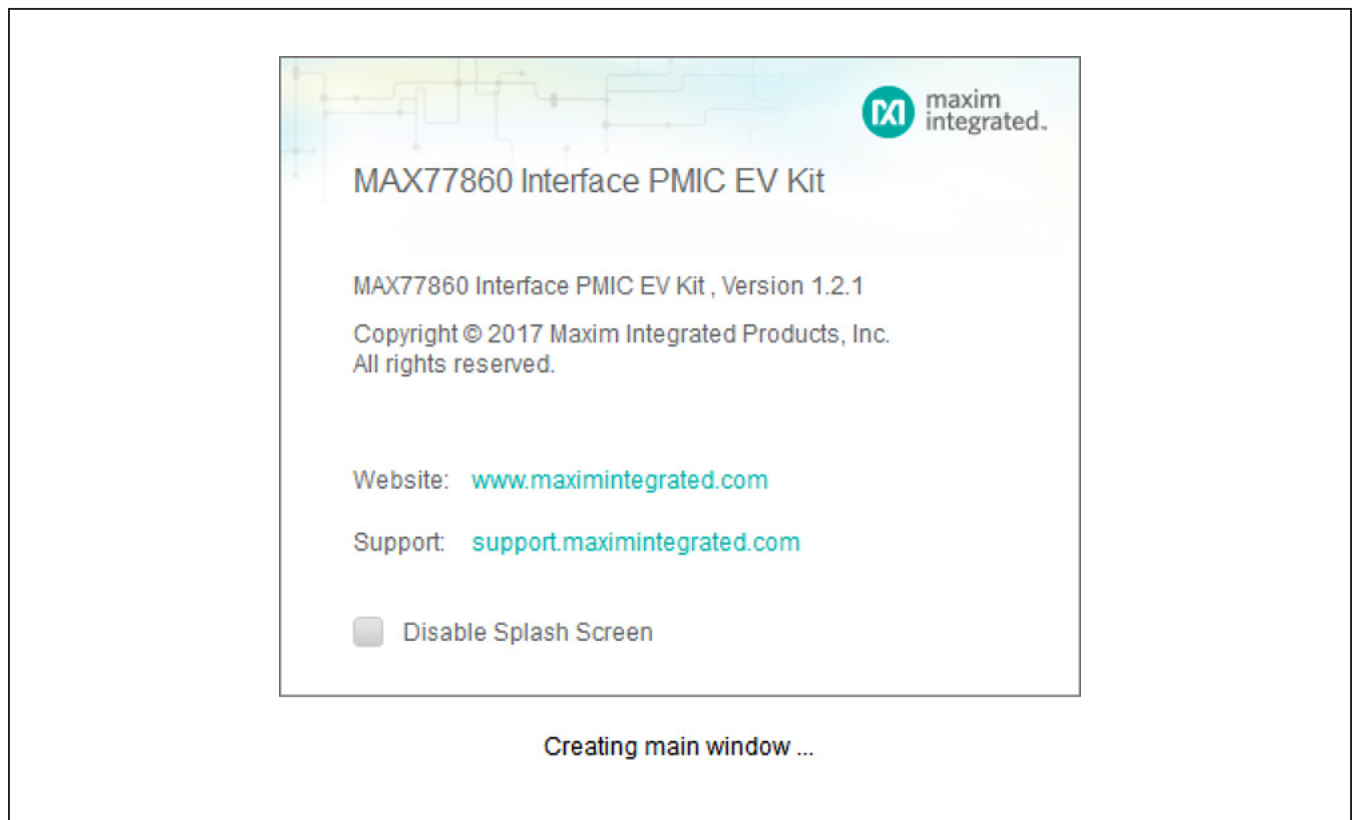

Figure 2. MAX77860 GUI Splash Screen

Communication

The software automatically finds the EV system board through USB identification. If the connection cannot be found, then a **Not Connected** message is displayed. Once the micro-USB cable is attached, click on the main window option, **Device > Connect**, and a synchronization

window appears. This window shows the IC sub-blocks and their corresponding slave addresses. Choose **Read and Close** and the status bar displays **Connected** to signify active communication. An example of a successful connection is shown in [Figure 3](#).

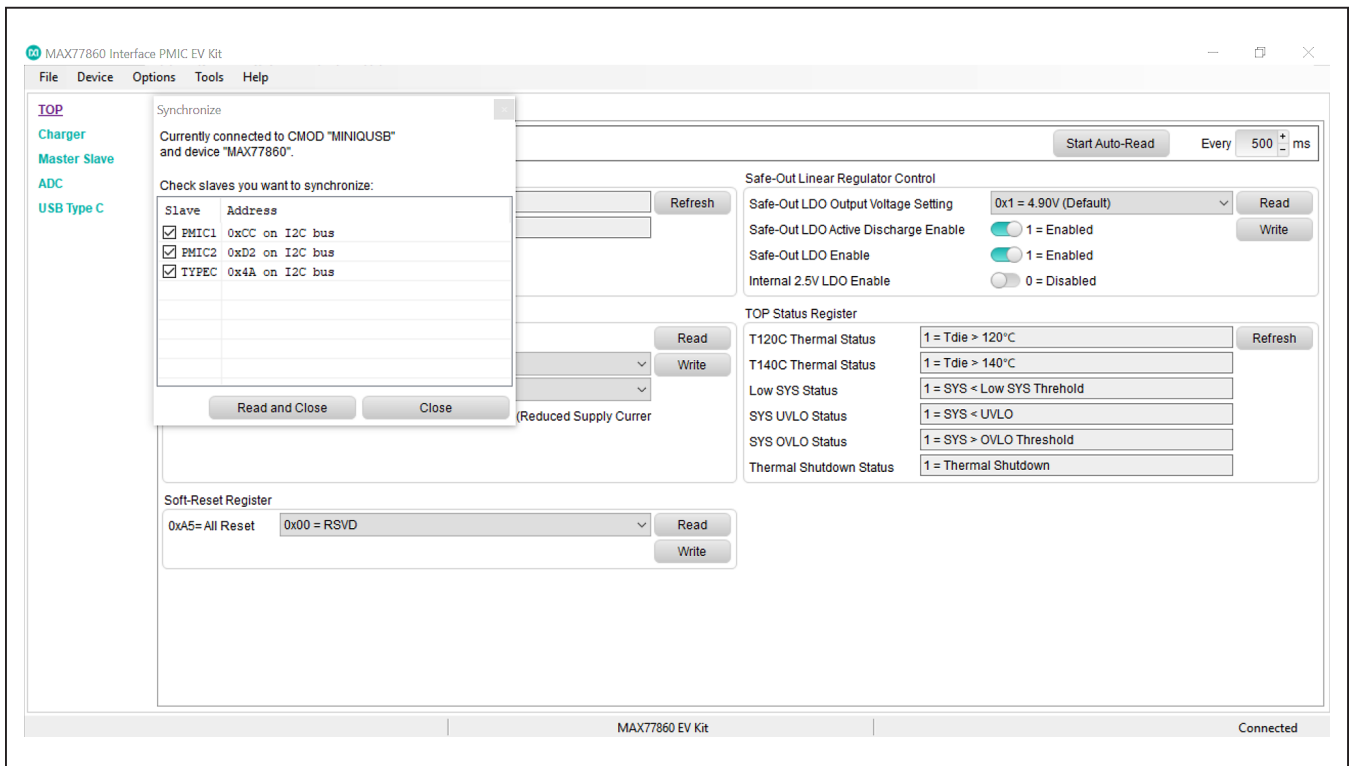

Figure 3. MAX77860 Communication Window

Main Display

Status bits and programmable functions of charger, master-slave, ADC, and USB Type-C can be accessed

through their respective interface tabs from the left column of the window (Figure 4).

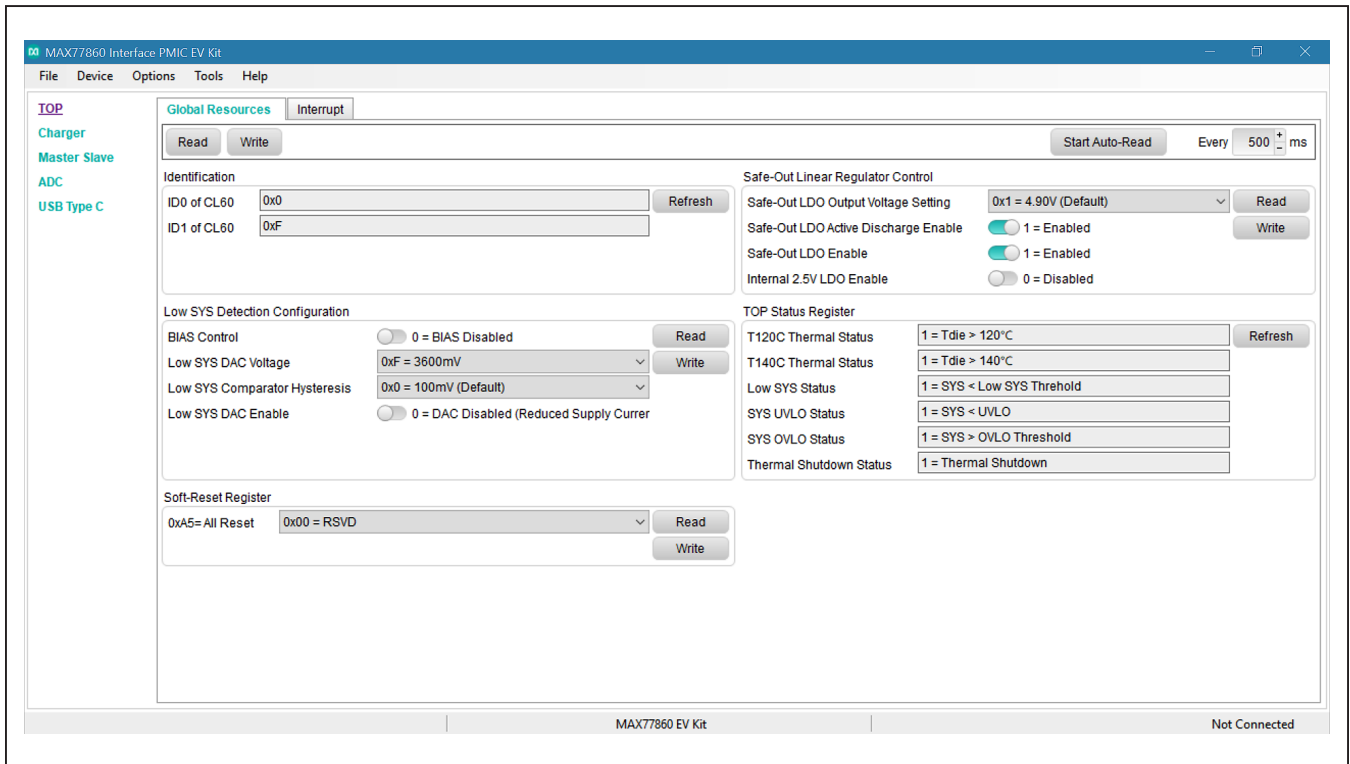

Figure 4. MAX77860 Top-Level Registers

Register Write Access

Modification of the charger registers are locked by default to prevent arbitrary changes. Therefore, changes made to the charger registers in the locked state are not applied to the EV system. To unlock register writing, select the **Unlocked** option from the drop-down list of **CHGPROT** in the **CHG Config 06/07/09** tab, and then click on **Write**. Read the register and **CHGPROT** should remain

in **Unlocked** state, signifying open register access. From this point onwards, modifications that are written to any of the registers are applied to the EV system. For example, the maximum input current limit can be changed from the **CHG Config 09** register by selecting the required value and clicking **Write**, but only after the registers have been unlocked from **CHG Config 06** (Figure 5).

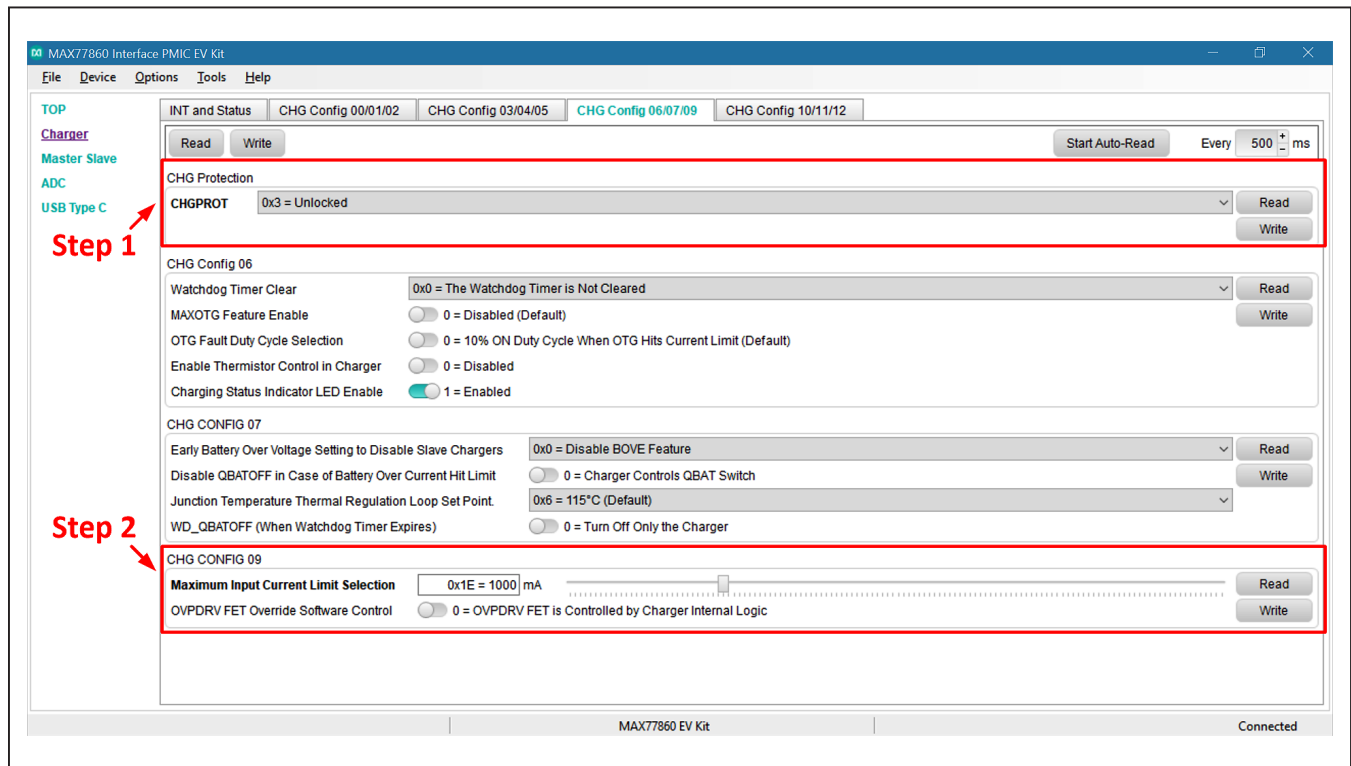

Figure 5. Charger Register Write Access

Detailed Description of Hardware

Battery Charger Test Setup

- 1) Power Source:
 - a. If the charging source is a DC power supply, then adjust its voltage and current limits to 5.0V and 3.0A, respectively. Connect the power supply between VBUS and GND on the EV kit board.
 - b. If the charging source is a wall adapter, then either the USB Type-C port or micro-USB port can be used for charging. Note that high current charging (up to 3A) requires an adapter and cable capable of high-power delivery.
- 2) Connect a single cell Li-ion battery between BATT and BATTGND.
 - 3) Open software screen and program the charger settings adequate to your system.
 - 4) In the **Charger** tab, disable the **USB Type C CTRL over CHG** bit in the **CHG_Config_00** to enable charging using the USB Type-C port or the micro-USB port.
 - 5) In the **USB Type C** tab, enable **NoAutoIBUS** in the **BC_CONTROL1** register so that the current limit setting can be manually controlled by I²C.
 - 6) Set the maximum input current limit in the **CHG Config 09** register, and then select the required fast charge current in the **CHG Config 02** register.
 - 7) Use data logging equipment to log charge current and VBATT profile while charging a fully discharged single cell Li-ion battery.

Jumper Settings

JUMPER NO.	PCB SILKSCREEN	DEFAULT POSITION	FUNCTION
J3	SLAVE	2-3	1-2: Connect to slave charger 2-3: Slave charger not present
J4	FLED1	Open	Open: Disconnect flash LEDs Close: Connect flash LEDs
J5	FLED2	Open	Open: Disconnect flash LEDs Close: Connect flash LEDs
J6	THM	1-2	1-2: Connect THM to potentiometer 2-3: Connect THM to thermistor
J7	VIO	1-2	1-2: Connect VIO to VSYS 2-3: Connect VIO to external I ² C pullup
J8	DETBATB	2-3	1-2: Connect DETBATB to VIO 2-3: Connect DETBATB to GND
J9, J17	GND	Open	Open: Disable SYS to input of U4 (Type-C block) Close: Enable SYS to input of U4 (Type-C block)
J10	THMB	Close	Open: Disconnect THMB from potentiometer Close: Connect THMB to potentiometer
J11	ONKEY	2-3	1-2: Disable ONKEY control of button SW-OKEY 2-3: Enable ONKEY control of button SW-OKEY
J12	CC1	Open	Open: Disable on-board Type-C emulation setting Close: Enable on-board Type-C emulation setting
J13	CC2	Open	Open: Disable on-board Type C emulation setting Close: Enable on-board Type C emulation setting
J15	VBUSDET	Open	Open: Disconnect CHGIN and VBUSDET Close: Connect CHGIN and VBUSDET

MAX77860 EV System Component List

DESIGNATION	QTY	DESCRIPTION	MANUFACTURER PART NO.
D+, D-, AVL, BST, CC1, CC2, CSN, CSP, PVL, SCL, SDA, SW1, SW2, THM, VIO, BYPS	16	TESTPOINT, PC MINI-RED	5000
BYP, BATT, GND1–GND4, PGND, VBUS, VSYS, CHGIN, BATTGND	11	WIRE, BUSS 20G PLATED SOLID COPPER	9020 BUSS
C1	1	CAP+,1000pF,10%,50V,C0G,0402	ANY
C2, C12, C19, C20	4	CAP+,1uF,10%,6.3V,X5R,0402	ANY
C3	1	CAP+,100pF,5%,50V,C0G,0402	ANY
C4	1	CAP+,2.2UF,10%,6.3V,X5R,0402	ANY
C5	1	CAP#,10uF,20%,6.3V,X5R,0402	ANY
C6	1	CAP+,2.2UF,10%,25V,X5R,0603	ANY
C7	1	CAP+,4.7uF,20%,10V,X5R,0402	ANY
C8, C9	2	CAP+,0.1uF,10%,25V,X7R,0402	GRM155R71E104KE14
C10, C15	2	CAP+,10UF,20%,16V,X5R,0603	ANY
C11, C13	2	CAP+,10uF,20%,25V, X5R,0603	C1608X5R1E106M080AC; CL10A106MA8NRNC
C14	1	CAP+,22uF,20%,10V, X5R,0603	ANY
C17	1	CAP+,100uF,20%,6.3V, TANT,1210	TCJB107M006R0070
C21	1	CAP+,1UF,20%,25V, X5R,0402	ANY
C22	1	CAP+,10uF,10%,6.3V, X7R,0805	GRM21BR70J106K; C2012X7R0J106K125AB
C23	1	CAP+,0.1uF,10%,10V, X5R,0402	ANY
C24	1	CAP+, 22UF 20% 10V TANT	PSLB31A226M
CHGGNDS	1	BLACK MINI TEST POINTS	5001
D3-D6	4	DIODE+, TVS,25V,4A,0402	RCLAMP0521PA
D10, D11	2	LED+, YELLOW, OSLO2.2V,350mA,3X3MM	GW CSSRM1.EC-MQMS-5H71-1
D12	1	LED+, SURFACE MOUNT GREEN (0603)	LTST-C190GKT
INFLED	1	PC TEST POINT RED	5010
J1	1	RCPT+, MICRO B USB 2.0,5 POS, SMD, R/A	10103592-0001LF
J2	1	SOCKET+,0.1",2X10POS, FEMALE, R/A,TH	PPTC102LJBN-RC
J3, J6–J8, J11	5	HEADER#,3POS,,100", SNGL, TIN	TSW-103-07-T-S
J4, J5, J9, J10, J12, J13, J15–J17	9	HEADER#,2POS,,100", SNGL, TIN	TSW-102-07-T-S
J14	1	CONN+,USB 3.1 RCPT,24 POS,RA,TH	898-43-024-90-310000
L1	1	INDCTR+,1 uH,20%,4.1A,1008	CIGT252010EH1R0M
L2	1	INDCTR+,1.2 uH,20%,5.8A,4.1X4.1MM	1127AS-1R2N

MAX77860 EV System Component List (continued)

DESIGNATION	QTY	DESCRIPTION	MANUFACTURER PART NO.
R1, R2	2	RES,2.2K OHM,1%,0402	CRCW04022K20FK; RC0402FR-072K2L
R3	1	RES#, 1.2M OHM,1%,0402	RK73H1ETTP1204F
R4	1	RES+, 120K OHM,1%,0402	CRCW0402120KFK
R5, R6	2	RES#,200K OHM,1%,0402	CRCW0402200KFK; RF73H1ELTP2003
R7, R8, R13, R14	4	RES#,0 OHM,5%,0402	ERJ-2GE0R00X
R9	1	RES,470 OHM,1%,0402	CRCW0402470RFK
R10	1	RES#, 10K OHM,1%,0402	CRCW040210K0FK; RC0402FR-0710K
R11	1	RES#, POT,100K OHM,10%,9.53X4.83MM	3296Y-1-104LF
R12	1	RES+,0.005 OHM,1%,1/2W,0603	RLM-0816-4F-R005-FNH
R16	1	RES#, 100 OHM,1%,0402	CRCW0402100RFK; 9C04021A1000FL; RC0402FR-07100RL
R17, R18	2	RES#,56K OHM,1%,0402	ERJ-2RKF5602X
RT1	1	RES#, THERM,10K 0,1%,0402	NCP15XH103F03RC
SW3, SW4, SW-ONKEY	3	PUSH BUTTON SWITCHES	EVQ-Q2K03W
U1	1	MAX77860EWG+	MAX77860
U2	1	MAX14681EWC+, MAX14699EWC+T	MAX14681EWC+, MAX14699EWC+T
U3	1	MAX8511EXK18+	MAX8511EXK18+
U4	1	MAX8815AETB+	MAX8815AETB+

Ordering Information

PART	TYPE
MAX77860EVKIT#	EV System

#Denotes RoHS compliance.

MAX77860 EV Kit Schematic

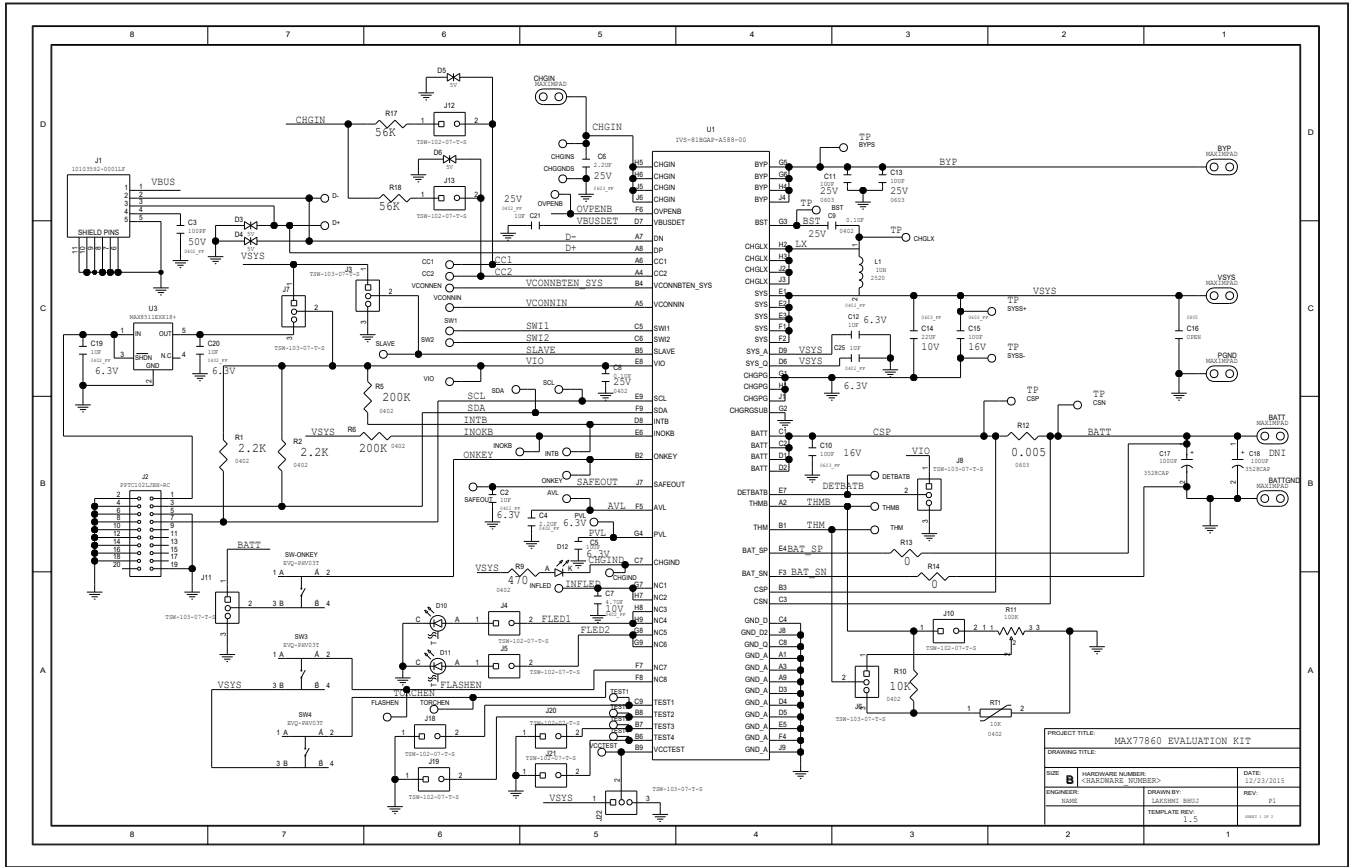

MAX77860 EV Kit Schematic (continued)

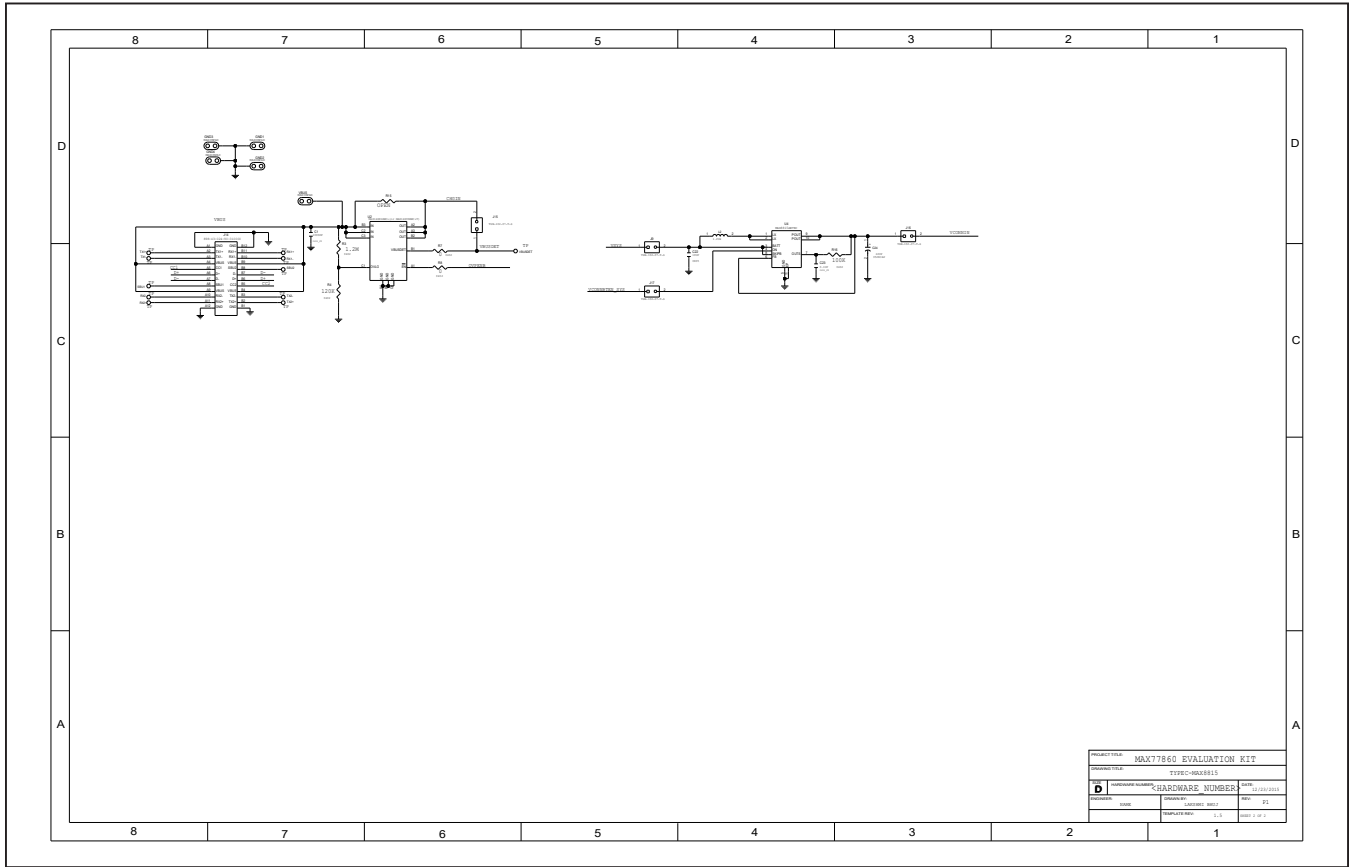

Revision History

REVISION NUMBER	REVISION DATE	DESCRIPTION	PAGES CHANGED
0	2/19	Initial release	—
1	2/19	Updated <i>Ordering Information</i>	9

For pricing, delivery, and ordering information, please visit Maxim Integrated's online storefront at <https://www.maximintegrated.com/en/storefront/storefront.html>.

Maxim Integrated cannot assume responsibility for use of any circuitry other than circuitry entirely embodied in a Maxim Integrated product. No circuit patent licenses are implied. Maxim Integrated reserves the right to change the circuitry and specifications without notice at any time.