



**Muffin AC - MU3B1 - 028029**  
 (Family) (Model) (Part Number)

## Electrical Specifications

Rated Voltage:	230 VAC
AC Frequency:	60 Hz
Power Supply:	14.0 Watts
Line Current:	0.09 Amps
Locked Rotor Current	0.13 Amps
Nominal Speed:	3100 RPM

## Mechanical Specifications

Dimensions:	4.72in x 1.50in
Weight	17.2 oz
Max Airflow @ 0 in H <sub>2</sub> O	102.0 CFM
Max Pressure @ 0 CFM	0.296 in H <sub>2</sub> O
Noise	45.1 dBA



**Comair Rotron, Inc.**  
 Phone: 858.348.6200  
[sales@comairrotron.com](mailto:sales@comairrotron.com)

**Comair Rotron Europe, Ltd.**  
 Phone: +44.1527.520525  
[saleseurope@comairrotron.com](mailto:saleseurope@comairrotron.com)

**Comair Rotron Fan Company Ltd.**  
 Phone: +86.21.52260581  
[salesasia@comairrotron.com](mailto:salesasia@comairrotron.com)

Print Date: Monday, February 18, 2008 at 00:52:49 - AC Fan Datasheet - Web Version 1.0 Rev. A



## Mechanical Drawing

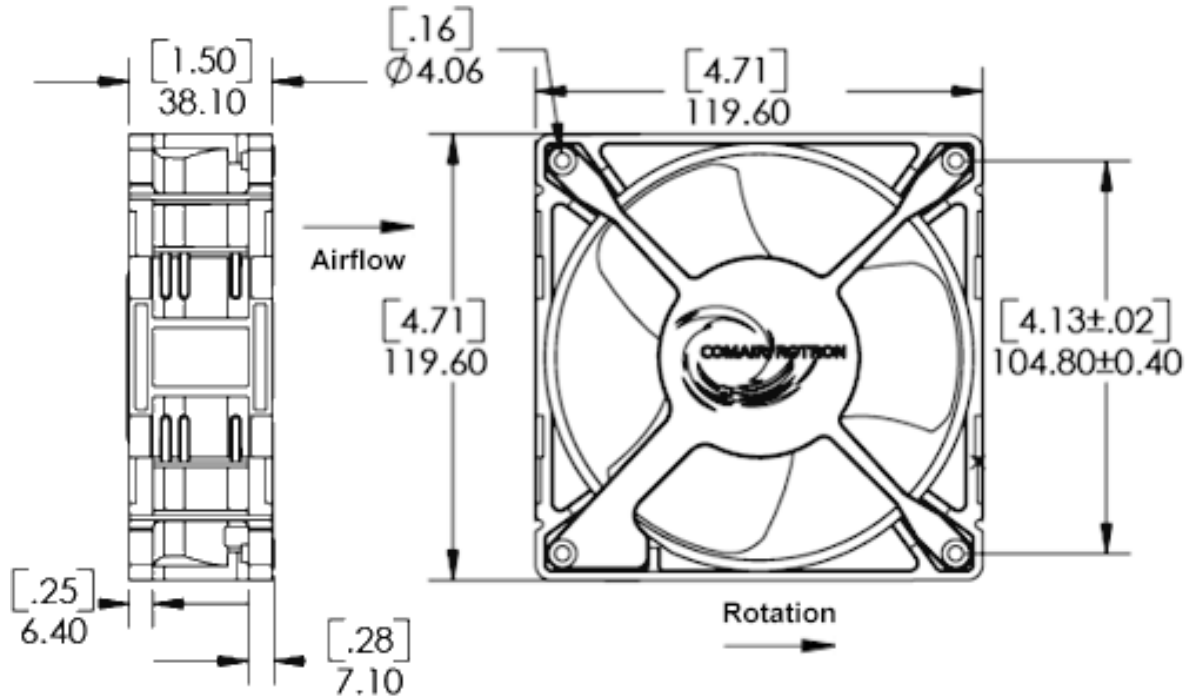

## Options

Part Number	Model Number	Bearing Type	Fan Rotation	Termination	In-Stock (Click 'Yes' for current stock)
028029	MU3B1	Ball	Normal	Terminals	No
028030	MU3B2	Ball	Normal	Terminals, No Venturi	No
039713	MU3B4	Ball	Reverse	Terminals, No Venturi	No
028023	MU3A1	Sleeve	Normal	Terminals	No
028024	MU3A2	Sleeve	Normal	Terminals, No Venturi	No
032876	MU3A4	Sleeve	Reverse	Terminals, No Venturi	No

## Accessories [\(Click on part number for detailed drawing.\)](#)

**428056**  
**Plug and Cord**

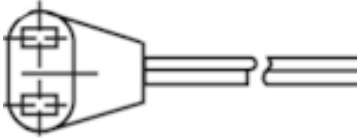

**477663**  
**Mounting Clip**

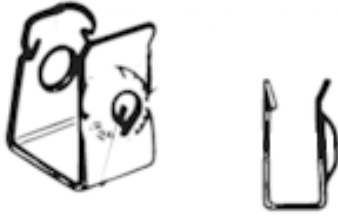

**551590**  
**Filter Assembly**

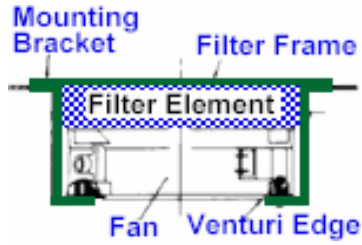

**554148**  
**Filter Guard Assembly**

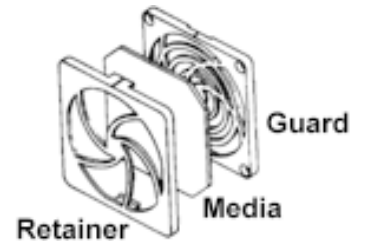

**552934**  
**Finger Guard**

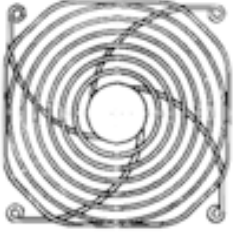

**476042**  
**Finger Guard**

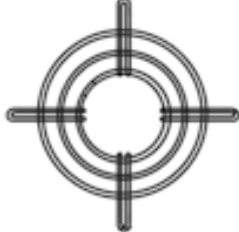

**550481**  
**Finger Guard**

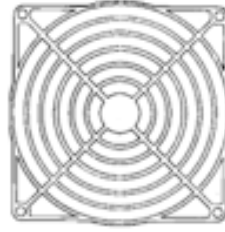

**551147**  
**Finger Guard**



**Comair Rotron, Inc.**  
Phone: 858.348.6200  
sales@comairrotron.com

**Comair Rotron Europe, Ltd.**  
Phone: +44.1527.520525  
saleseurope@comairrotron.com

**Comair Rotron Fan Company Ltd.**  
Phone: +86.21.52260581  
salesasia@comairrotron.com