



Terminal blades with no holes for better fit in sockets.

Integral LED (Red for AC, Green for DC coils).

Universal 24VAC/DC coil version (Yellow LED).

Locking Test Lever standard

Back EMF Diode standard for DC Coils.

Welded internal connections for greater reliability.



### Contacts

Contact arrangement		4PDT (4CO, 4 Form C)
Contact material		AgNi90/10 +0.2um Au, AgNi90/10+5um Au
Max switching voltage	AC/DC	277VAC, 30VDC
Rated load (resistive, cos φ=1)	AC1	5A/240VAC
	DC1	5A/28VDC
Initial contact resistance		≤ 100mΩ

### Coil

Rated Voltage (see page 2)	DC	6... 110V
	AC 50/60Hz	6... 240V
	AC/DC	24V (universal AC or DC)
Rated power consumption		DC: 0.9W / AC: 1.2VA

### Insulation

Insulation resistance		≥1000MΩ at 500VDC, 50%RH
Dielectric strength	coil to contact	2500Vrms, 1min, 1mA
	contact to contact	1000Vrms, 1min, 1mA
	between adjacent contacts	2000Vrms, 1min, 1mA

### General Data

Operate / bounce time	typical	≤ 10ms / ≤ 3ms
Release / bounce time	typical	≤ 6ms / ≤ 1ms
Electrical life		1 x 10 <sup>5</sup> (at rated load)
Mechanical life		1 x 10 <sup>7</sup> (max. switching rate = 1200ops/hr)
Ambient temperature	operating	-40 to 70°C
	storage	-40 to 80°C (no icing)
Shock resistance		Functional: 10g 11ms
Vibration resistance		DA 1.0mm 10-55Hz
Dimensions	L x W x H	27 x 21 x 36.7mm (excluding terminals)
Weight		approx. 40g

### Ordering Code

D X N - 1 3 - 3 0 2 4 -

DXN: Series

1: AgNi90/10 + 0.2um Au

3: AgNi90/10 + 5um Au

3: for plug-in sockets only (IP40)

5: for PCB mounting only (IP40)

1: DC Coil with diode

3: AC 50/60Hz Coil

U: Universal AC/DC Coil

see coil tables 1, 2 & 3 for full code

### Standard Features

	LED Indication		Test Lever
*	AC Coil	Red	Red
*	DC Coil	Green	Blue
*	24VAC/DC Coil	Yellow	Grey
*	Back EMF diode for all DC Coils		

NIL: Standard part, blue top, with test lever and LED.

B: No test lever, but with LED

# DXN series

## industrial 4PDT plug-in relay



Coil Data (DC voltage) Green LED Table 1

Coil Voltage Code	Nominal Voltage (VDC)	Coil Resistance ( $\Omega$ ) $\pm 10\%$ (at 23°C)	Power Consumption (mW)	Must Operate Voltage max. (VDC)	Must Release Voltage min. (VDC)	Max. Allowable Voltage (VDC)
1006	6	40	900	4.5	0.6	6.6
1012	12	160	900	9.0	1.2	13.2
1024	24	640	900	18.0	2.4	26.4
1048	48	2600	900	36.0	4.8	52.8
1110	110	13600	900	82.5	11.0	121.0

Coil Data (AC voltage 50/60Hz) Red LED Table 2

Coil Voltage Code	Nominal Voltage (VAC)	Coil Resistance ( $\Omega$ ) $\pm 10\%$ (at 23°C)	Power Consumption (VA)	Must Operate Voltage max. (VAC)	Must Release Voltage min. (VAC)	Max. Allowable Voltage (VAC)
3006	6	10	1.2	4.8	1.8	6.6
3012	12	40	1.2	9.6	3.6	13.2
3024	24	158	1.2	19.2	7.2	26.4
3048	48	640	1.2	38.4	14.4	52.8
3110	110	3450	1.2	88.0	33.0	121.0
3120	120	4200	1.2	96.0	36.0	132.0
3230	220/230	15400	1.2	176.0	66.0	242.0
3240	240	16800	1.2	192.0	72.0	264.0

Coil Data (Universal AC/DC Voltage\*) Yellow LED Table 3

Coil Voltage Code	Nominal Voltage (VAC or VDC)	Coil Resistance ( $\Omega$ ) $\pm 10\%$ (at 23°C)	Power Consumption (W)	Must Operate Voltage max.	Must Release Voltage min.	Max. Allowable Voltage
U024	24	495.6	0.9	18.0	2.4	26.4

\* Bridge rectifier circuit with LED indication. See wiring diagram below.

Connection Diagram Fig 1

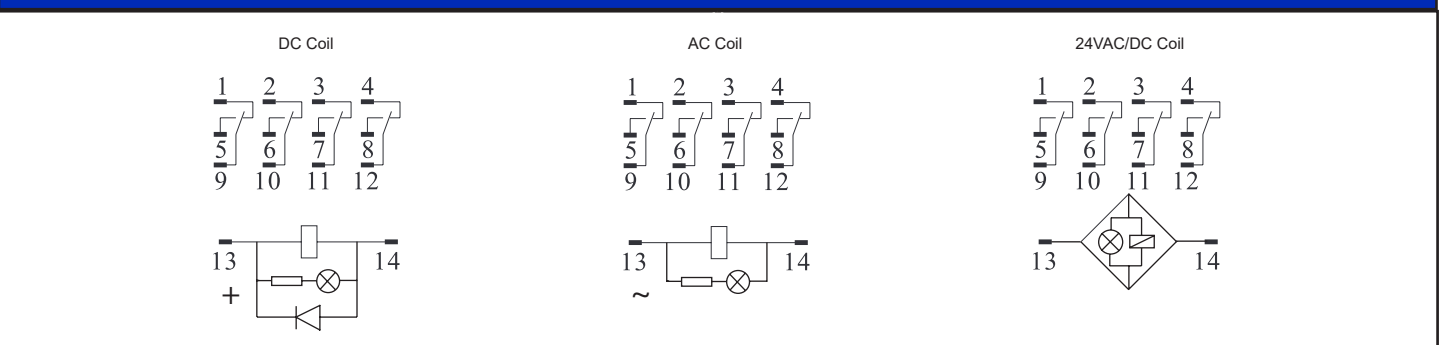

Dimensions Fig 2

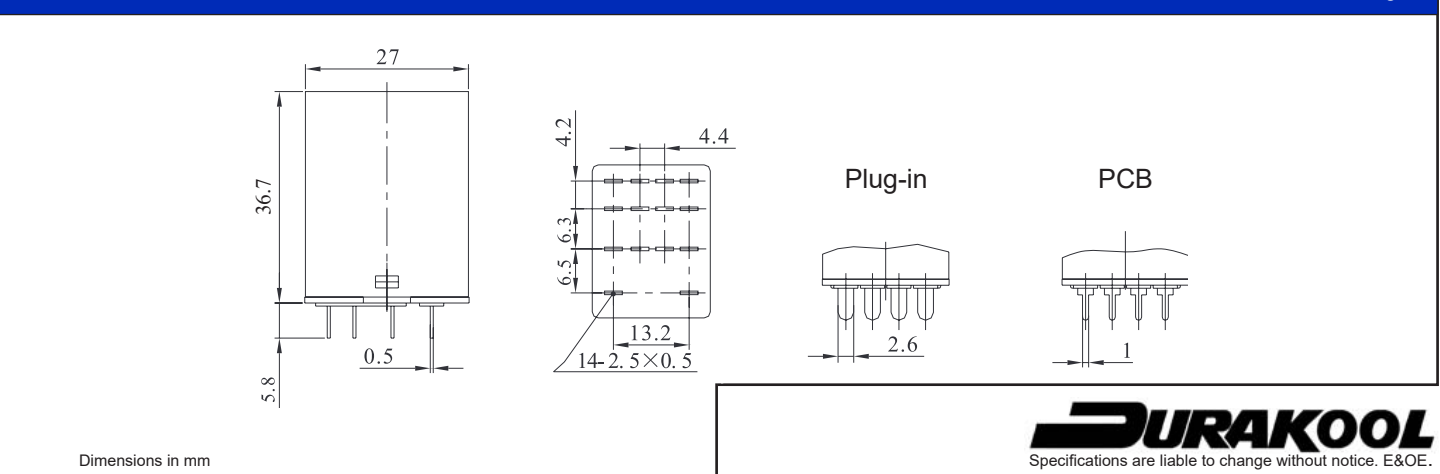







# DXN series

## industrial 4PDT plug-in relay

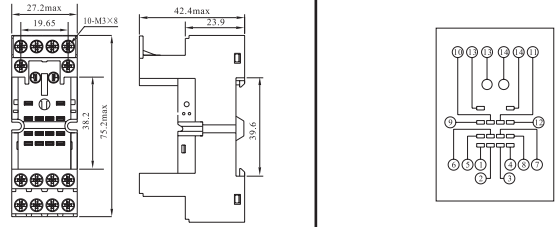
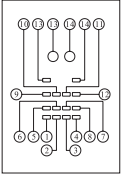

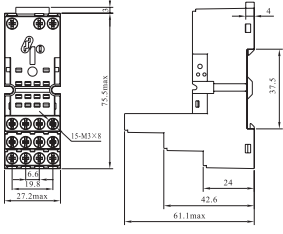
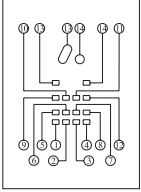
### Mounting Sockets for DXN relays

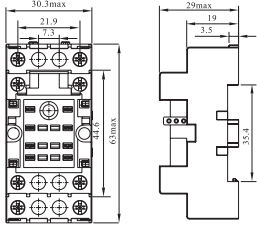
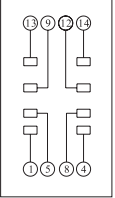
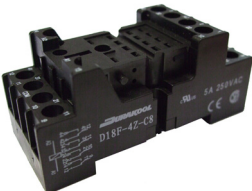
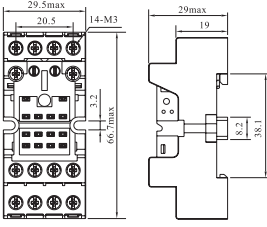
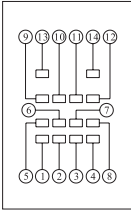
Fig 3

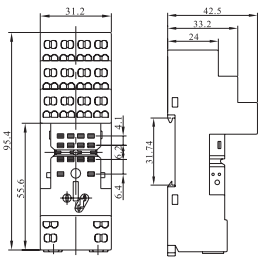
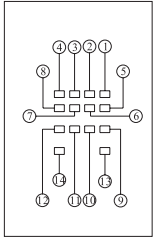
<p>D18F-4Z-C4</p> 	<p>Rated voltage : 300VAC            Rated current : 10A            Insulation voltage : <math>\geq</math> 3KV            Socket material : PA46-S250F6 (V1/V0)            Contacts spring material : QSn6.5-0.1</p> <p>Options:            Steel Wire Hold down spring: JH-36MS-B            Plastic Ejector clip: JH-36PS-A</p> <p>Plug-in Accessory Modules:            DM41G-BK Green LED 6/24VDC            DM41R-BK Red LED 6/24VDC            DM61G-BK Green LED 6/24VAC/DC with diode            DM63G-BK Green LED 110/230VAC/DC            DM63R-BK Red LED 110/230VAC/DC            DM91G-BK Green LED 6/24VAC/DC with varistor            DM93G-BK Green LED 110/230VAC/DC with varistor</p> <p>Other modules upon request.</p>		
<p>D18F-4Z-C5</p> 	<p>Rated voltage : 300VAC            Rated current : 10A            Insulation voltage : <math>\geq</math> 3KV            Socket material : PA46-S250F6 (V1/V0)            Contacts spring material : QSn6.5-0.1</p> <p>Options:            Steel Wire Hold down spring: JH-36MS-B            Plastic Ejector clip: JH-36PS-A</p> <p>Plug-in Accessory Modules:            DM41G-BK Green LED 6/24VDC            DM41R-BK Red LED 6/24VDC            DM61G-BK Green LED 6/24VAC/DC with diode            DM63G-BK Green LED 110/230VAC/DC            DM63R-BK Red LED 110/230VAC/DC            DM91G-BK Green LED 6/24VAC/DC with varistor            DM93G-BK Green LED 110/230VAC/DC with varistor</p> <p>Other modules upon request.</p>		
<p>D18F-4Z-C7</p> 	<p>Rated voltage : 250VAC            Rated current : 5A            Insulation voltage : <math>\geq</math> 3KV            Socket material : PA66+GF (V1/V0)            Contacts spring material : QSn6.5-0.1</p> <p>Options:            Steel Wire Hold down spring: JH-36MS-B</p>		
<p>D18F-4Z-C8</p> 	<p>Rated voltage : 300VAC            Rated current : 10A            Insulation voltage : <math>\geq</math> 3KV            Socket material : PA66+GF (V1/V0)            Contacts spring material : QSn6.5-0.1</p> <p>Options:            Steel Wire Hold down spring: JH-36MS-B            Plastic Ejector Clip: JH-36PS-A</p> <p>Plug-in Accessory Modules:            DM41G-BK Green LED 6/24VDC            DM41R-BK Red LED 6/24VDC            DM61G-BK Green LED 6/24VAC/DC with diode            DM63G-BK Green LED 110/230VAC/DC            DM63R-BK Red LED 110/230VAC/DC            DM91G-BK Green LED 6/24VAC/DC with varistor            DM93G-BK Green LED 110/230VAC/DC with varistor</p> <p>Other modules upon request.</p>		
<p>D18F-4Z-C9</p> 	<p>Rated voltage : 300VAC            Rated current : 10A            Insulation voltage : <math>\geq</math> 3KV            Socket material : PA66+GF (V1/V0)            Contacts spring material : QSn6.5-0.1</p> <p>Options:            Steel Wire Hold down spring: JH-36MS-B            Plastic Ejector Clip: JH-36PS-A</p> <p>Plug-in Accessory Modules:            DM41G-BK Green LED 6/24VDC            DM41R-BK Red LED 6/24VDC            DM61G-BK Green LED 6/24VAC/DC with diode            DM63G-BK Green LED 110/230VAC/DC            DM63R-BK Red LED 110/230VAC/DC            DM91G-BK Green LED 6/24VAC/DC with varistor            DM93G-BK Green LED 110/230VAC/DC with varistor</p> <p>Other modules upon request.</p>		

Dimensions in mm

