

VW3A46109

passive filter - 75 A - 400 V - 50 Hz - for variable speed drive

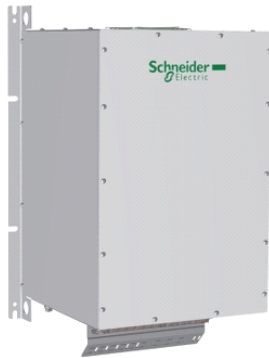

Main

Product or component type	Passive filter
Product specific application	Reduction of current harmonics

Complementary

Range compatibility	Altivar 61 Altivar 71 Altivar Process ATV600 Altivar Process ATV900
[Us] rated supply voltage	400 V (+/- 10 %)
Supply frequency	50 Hz (tolerance: +/- 2 %)
Quantity per drive	1 filter per drive for variable speed drive ATV61W motor: 37 kW / 50 hp 1 filter per drive for variable speed drive ATV61H motor: 37 kW / 50 hp 1 filter per drive for variable speed drive ATV71H motor: 37 kW / 50 hp 1 filter per drive for variable speed drive ATV71W motor: 37 kW / 50 hp 1 filter per drive for variable speed drive ATV650 wall mount, motor: 37 kW / 50 hp 1 filter per drive for variable speed drive ATV630 wall mount, motor: 37 kW / 50 hp 1 filter per drive for variable speed drive ATV950 wall mount, motor: 37 kW / 50 hp 1 filter per drive for variable speed drive ATV930 wall mount, motor: 37 kW / 50 hp
[In] rated current	72 A for input 75 A for output
Network number of phases	3 phases
THDI	10 % for variable speed drive ATV61W motor: 37 kW / 50 hp 16 % for variable speed drive ATV61H motor: 37 kW / 50 hp 16 % for variable speed drive ATV71H motor: 37 kW / 50 hp 16 % for variable speed drive ATV71W motor: 37 kW / 50 hp 10 % for variable speed drive ATV650 motor: 37 kW / 50 hp 10 % for variable speed drive ATV630 motor: 37 kW / 50 hp 10 % for variable speed drive ATV950 motor: 37 kW / 50 hp 10 % for variable speed drive ATV930 motor: 37 kW / 50 hp
Max current	1.5 x nominal current (duration = 60 s)
Efficiency	<= 98 %
Thermal losses	374 W
Cos phi	1 at 150 % of line current 0.85 at 75 % of line current 0.99 at 100 % of line current
Electrical connection	A, B terminal, connection capacity: 2.5 mm ² X1-1...X2-3 terminal, connection capacity: 2.5...25 mm ²
Electrical insulation class	Class F
Product weight	56 kg

Environment

IP degree of protection	IP20 IP55 (enclosure mounting)
vibration resistance	2 mm peak to peak (f = 5...13.2 Hz) conforming to EN 60068-2-6 0.7 gn (f = 13.2...150 Hz) conforming to EN 60068-2-6
relative humidity	5...85 % without condensation
ambient air temperature for operation	> 45...60 °C with current derating 3 % per °C 5...45 °C without current derating

The information provided in this documentation contains general descriptions and/or technical characteristics of the products contained herein. This documentation is not intended as a substitute for and is not to be used for determining suitability or reliability of these products for specific user applications. It is the duty of any such user or integrator to perform the appropriate and complete risk analysis, evaluation and testing of the products with respect to the relevant specific application or use thereof. Neither Schneider Electric Industries SAS nor any of its affiliates or subsidiaries shall be responsible or liable for misuse of the information contained herein.

ambient air temperature for storage	> -25...55 °C storage in original packaging > -25...65 °C during transport
operating altitude	<= 1000 m without current derating > 1000...4000 m with current derating 5 % per 1000 m
standards	EN/IEC 61000-3-2 EN/IEC 61000-3-12 EN/IEC 61000-3-4 EN/IEC 61000-2-2 EN/IEC 61000-2-4 G5/4 engineering recommendation

Offer Sustainability

Sustainable offer status	Not Green Premium product
RoHS (date code: YYWW)	Compliant - since 1329 - Schneider Electric declaration of conformity

Dimensions

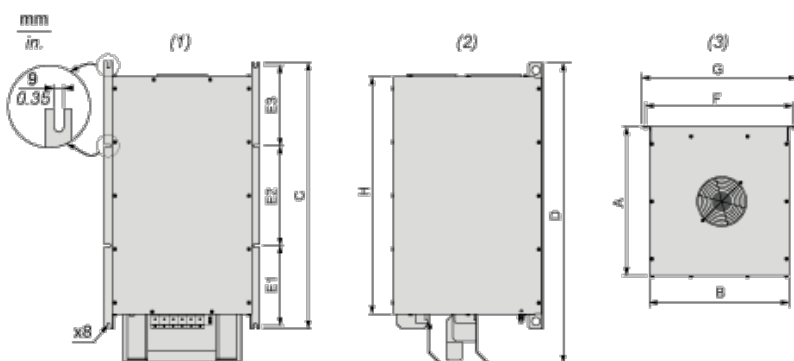

- (1) Front view
- (2) Right side view
- (3) Top view

Dimensions in mm

A	B	C	D	E1	E2	E3	F	G	H
333	330	577	623.6	156.5	240	156.5	353	378	490

Dimensions in in.

A	B	C	D	E1	E2	E3	F	G	H
13.11	12.99	22.72	24.55	6.16	9.45	6.16	13.90	14.88	19.29

Mounting Recommendations

Vertical Mounting Only

mm
in.

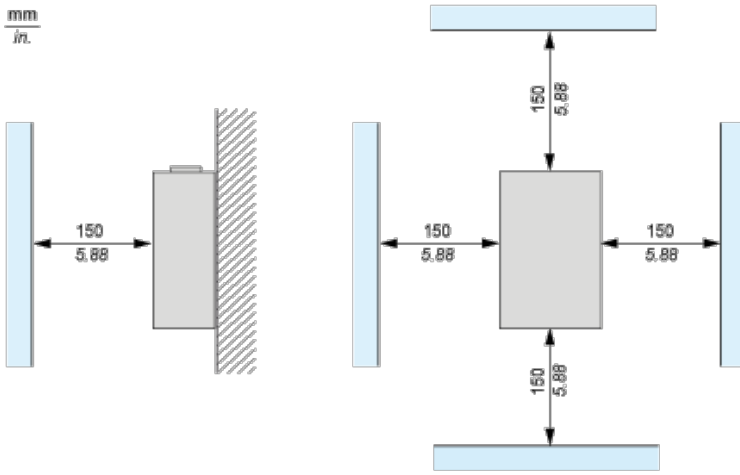

(1) Filter

Recommended Schema

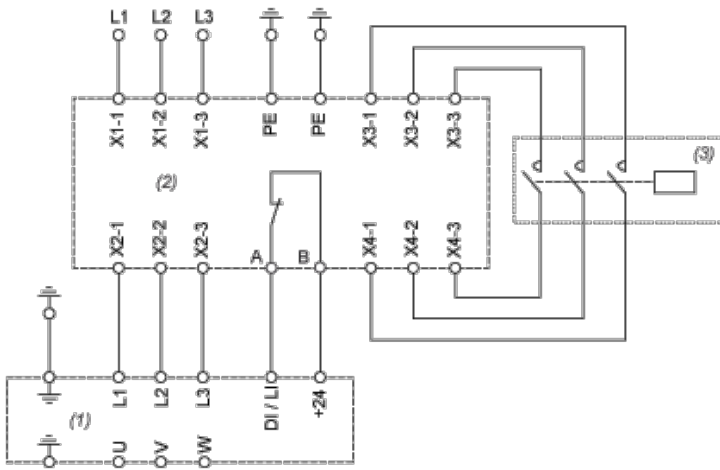

- (1) Drive
- (2) Filter
- (3) Optional