

Datenblatt | Artikelnummer: 2206-1301

3-Leiter-Durchgangsklemme; mit Drücker; 6 mm²; mit Prüföffnung; seitliche und mittige Beschriftung; für Tragschiene 35 x 15 und 35 x 7,5; Push-in
CAGE CLAMP®

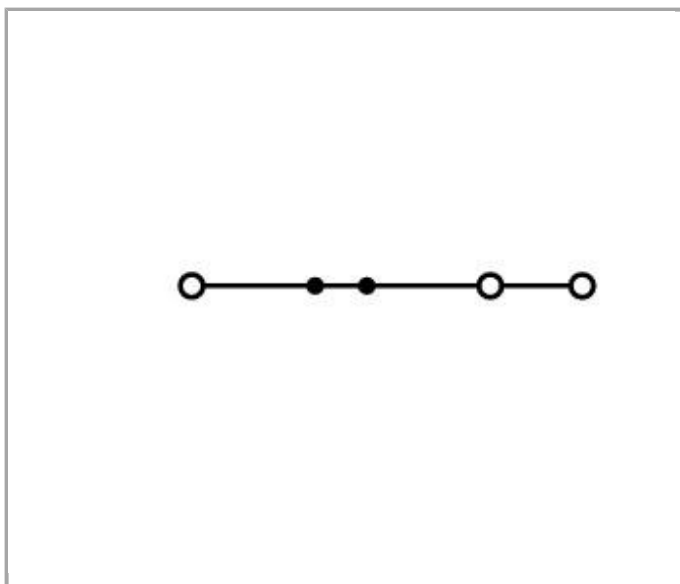

www.wago.com/2206-1301

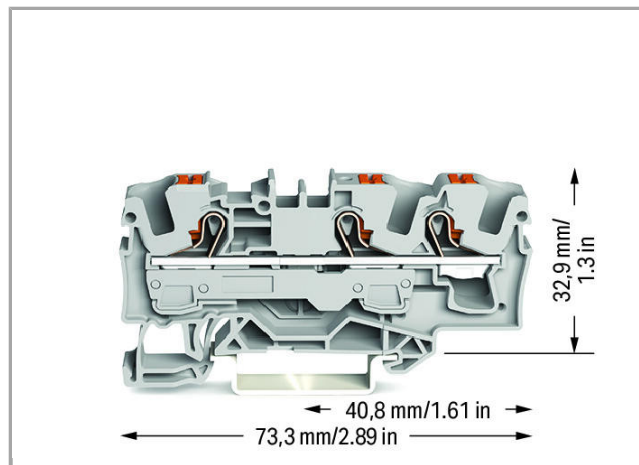
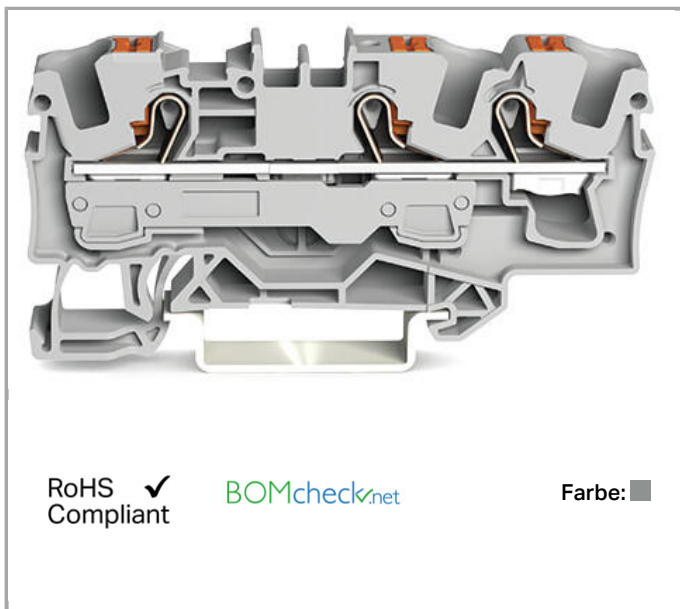

Daten

Elektrische Daten

Bemessungsdaten gemäß IEC/EN 60664-1

Bemessungsspannung (III / 3)	800 V
Bemessungsstoßspannung (III / 3)	8 kV
Bemessungsstrom	41 A

Bemessungsstrom 2	57 A
-------------------	------

Bemessungsdaten gemäß UL 1059

Bemessungsspannung UL (Use Group B)	600 V
Bemessungsstrom UL (Use Group B)	50 A
Bemessungsspannung UL (Use Group C)	600 V
Bemessungsstrom UL (Use Group C)	50 A

Anschlussdaten

Anschluss technik	Push-in CAGE CLAMP®
Betätigungsart	Push-in Drücker Betätigungswerkzeug
Anschließbare Leiterwerkstoffe	Kupfer
Nennquerschnitt	6 mm ²
Eindrätiger Leiter	0,5 ... 10 mm ² / 20 ... 8 AWG
Eindrätiger Leiter; direkt steckbar	1 ... 10 mm ² / 14 ... 8 AWG
Feindrätiger Leiter	0,5 ... 10 mm ² / 20 ... 8 AWG
Abisolierlänge	13 ... 15 mm / 0.51 ... 0.59 inch
Hinweis (Leiterquerschnitt)	Je nach Beschaffenheit des Leiters kann auch ein Leiter geringeren Querschnitts direkt steckbar sein.
Gesamte Anzahl der Klemmstellen	3
Gesamte Anzahl der Potentiale	1
Anzahl der Ebenen	1
Verdrahtungsart	Frontverdrahtung
Leiterquerschnitte eindrätig	0.5 mm ²

Geometrische Daten

Breite	7,5 mm / 0.295 inch
Höhe ab Oberkante Tragschiene	32,9 mm / 1.295 inch
Tiefe	73,3 mm / 2.886 inch

Mechanische Daten

Bauform	horizontale Bauform
Montageart	Tragschiene 35
Beschriftungsebene	Mitten-/Seitliche Beschriftung

Werkstoffdaten

Farbe	grau
Isolierwerkstoff	Polyamid 66 (PA 66)



Brandlast	0.215 MJ
Gewicht	12.934 g

Kaufmännische Daten



Ursprungsland	DE
GTIN	4055143712088
Zolltarifnummer	85369010000

Zulassungen / Zertifikate

Ex-Zulassungen

Logo	Zulassung	Norm	Zertifikatsname
	AEx Underwriters Laboratories Inc.	UL 60079	4788362294
	ATEX Physikalisch Technische Bundesanstalt	IEC 60079-0	PTB 18 ATEX 1007 U
	IECEX Physikalisch Technische Bundesanstalt	IEC 60079	IECEX PTB 18.0014U (Ex eb IIC Gb and Ex eb I Mb)

Länderspezifische Zulassungen







Logo	Zulassung	Norm	Zertifikatsname
	CCA DEKRA Certification B.V.	EN 60947	NTR NL 7667
	CSA DEKRA Certification B.V.	C22.2	70175034
	KEMA/KEUR DEKRA Certification B.V.	EN 60947	71-102879

UL-Zulassungen

Logo	Zulassung	Norm	Zertifikatsname
	UL Underwriters Laboratories Inc.	C22.2 No. 158	478863229

Passende Produkte





Aderendhülse

	Art-Nr.: 216-208 Aderendhülse; Hülse für 6 mm ² / AWG 10; mit Kunststoffkragen; galvanisch verzinkt; Elektrolytkupfer; www.wago.com/216-208 gasdicht aufgecrimpt; gemäß DIN 46228, Teil 4/09.90
	Art-Nr.: 216-262 Aderendhülse; Hülse für 0,75 mm ² / AWG 18; mit Kunststoffkragen; galvanisch verzinkt; Elektrolytkupfer; www.wago.com/216-262 gasdicht aufgecrimpt; gemäß DIN 46228, Teil 4/09.90
	Art-Nr.: 216-263 Aderendhülse; Hülse für 1 mm ² / AWG 18; mit Kunststoffkragen; galvanisch verzinkt; Elektrolytkupfer; www.wago.com/216-263 gasdicht aufgecrimpt; gemäß DIN 46228, Teil 4/09.90
	Art-Nr.: 216-264 Aderendhülse; Hülse für 1,5 mm ² / AWG 16; mit Kunststoffkragen; galvanisch verzinkt; Elektrolytkupfer; www.wago.com/216-264 gasdicht aufgecrimpt; gemäß DIN 46228, Teil 4/09.90
	Art-Nr.: 216-266 Aderendhülse; Hülse für 2,5 mm ² / AWG 14; mit Kunststoffkragen; galvanisch verzinkt; Elektrolytkupfer; www.wago.com/216-266 gasdicht aufgecrimpt; gemäß DIN 46228, Teil 4/09.90
	Art-Nr.: 216-267 Aderendhülse; Hülse für 4 mm ² / AWG 12; mit Kunststoffkragen; galvanisch verzinkt; Elektrolytkupfer; www.wago.com/216-267 gasdicht aufgecrimpt; gemäß DIN 46228, Teil 4/09.90



Werkzeug













	Art-Nr.: 210-721 Betätigungswerkzeug mit teilisoliertem Schaft; Typ 3, Klinge (5,5 x 0,8) mm www.wago.com/210-721
--	---

















Abschlussplatte

	Art-Nr.: 2006-1391 Abschluss- und Zwischenplatte; 1 mm dick www.wago.com/2006-1391
	Art-Nr.: 2006-1392 Abschluss- und Zwischenplatte; 1 mm dick www.wago.com/2006-1392
	Art-Nr.: 2006-1393 Trennwand; 2 mm dick; überstehend www.wago.com/2006-1393
	Art-Nr.: 2006-1394 Trennwand; 2 mm dick; überstehend www.wago.com/2006-1394

Beschriftungsmaterial

	Art-Nr.: 2009-110 Beschriftungsstreifen; auf Rolle; nicht dehnbar; unbedruckt; aufrastbar www.wago.com/2009-110
	Art-Nr.: 2009-115 WMB-Inline; für Smart Printer; auf Rolle; dehnbar 5 - 5,2 mm; unbedruckt; aufrastbar www.wago.com/2009-115

	Art-Nr.: 2009-115/000-002 WMB-Inline; für Smart Printer; auf Rolle; dehnbar 5 - 5,2 mm; unbedruckt; aufrastbar	www.wago.com/2009-115/000-002
	Art-Nr.: 2009-115/000-006 WMB-Inline; für smartPRINTER; auf Rolle; dehnbar 5 - 5,2 mm; unbedruckt; aufrastbar	www.wago.com/2009-115/000-006
	Art-Nr.: 2009-115/000-007 WMB-Inline; für Smart Printer; auf Rolle; dehnbar 5 - 5,2 mm; unbedruckt; aufrastbar	www.wago.com/2009-115/000-007
	Art-Nr.: 2009-115/000-012 WMB-Inline; für smartPRINTER; auf Rolle; dehnbar 5 - 5,2 mm; unbedruckt; aufrastbar	www.wago.com/2009-115/000-012
	Art-Nr.: 2009-115/000-017 WMB-Inline; für Smart Printer; auf Rolle; dehnbar 5 - 5,2 mm; unbedruckt; aufrastbar	www.wago.com/2009-115/000-017
	Art-Nr.: 2009-115/000-023 WMB-Inline; für Smart Printer; auf Rolle; dehnbar 5 - 5,2 mm; unbedruckt; aufrastbar	www.wago.com/2009-115/000-023
	Art-Nr.: 2009-115/000-024 WMB-Inline; für smartPRINTER; auf Rolle; dehnbar 5 - 5,2 mm; unbedruckt; aufrastbar	www.wago.com/2009-115/000-024
	Art-Nr.: 2009-145 Mini-WSB Inline; für Smart Printer; auf Rolle; dehnbar 5 - 5,2 mm; unbedruckt; aufrastbar	www.wago.com/2009-145
	Art-Nr.: 2009-145/000-002 Mini-WSB Inline; für Smart Printer; auf Rolle; dehnbar 5 - 5,2 mm; unbedruckt; aufrastbar	www.wago.com/2009-145/000-002
	Art-Nr.: 2009-145/000-005 Mini-WSB Inline; für Smart Printer; auf Rolle; dehnbar 5 - 5,2 mm; unbedruckt; aufrastbar	www.wago.com/2009-145/000-005
	Art-Nr.: 2009-145/000-006 Mini-WSB Inline; für Smart Printer; auf Rolle; dehnbar 5 - 5,2 mm; unbedruckt; aufrastbar	www.wago.com/2009-145/000-006
	Art-Nr.: 2009-145/000-007 Mini-WSB Inline; für Smart Printer; auf Rolle; dehnbar 5 - 5,2 mm; unbedruckt; aufrastbar	www.wago.com/2009-145/000-007
	Art-Nr.: 2009-145/000-012 Mini-WSB Inline; für Smart Printer; auf Rolle; dehnbar 5 - 5,2 mm; unbedruckt; aufrastbar	www.wago.com/2009-145/000-012
	Art-Nr.: 2009-145/000-023 Mini-WSB Inline; für smartPRINTER; auf Rolle; dehnbar 5 - 5,2 mm; unbedruckt; aufrastbar	www.wago.com/2009-145/000-023
	Art-Nr.: 2009-145/000-024 Mini-WSB Inline; für Smart Printer; auf Rolle; dehnbar 5 - 5,2 mm; unbedruckt; aufrastbar	www.wago.com/2009-145/000-024

	Art-Nr.: 2009-191 Gruppenschildträger	www.wago.com/2009-191
	Art-Nr.: 2009-192 Gruppenschildträger	www.wago.com/2009-192
	Art-Nr.: 2009-193 Gruppenschildträger	www.wago.com/2009-193
	Art-Nr.: 2009-198 Adapter	www.wago.com/2009-198
	Art-Nr.: 248-501 Mini-WSB-Schnellbeschriftungssystem; unbedruckt; Schildchenbreite 5 mm; 10 Streifen à 10 Schilder pro Karte	www.wago.com/248-501
	Art-Nr.: 248-501/000-002 Mini-WSB-Beschriftungskarte; als Karte; nicht dehnbar; unbedruckt; aufrastbar	www.wago.com/248-501/000-002
	Art-Nr.: 248-501/000-005 Mini-WSB-Beschriftungskarte; als Karte; nicht dehnbar; unbedruckt; aufrastbar	www.wago.com/248-501/000-005
	Art-Nr.: 248-501/000-006 Mini-WSB-Beschriftungskarte; als Karte; nicht dehnbar; unbedruckt; aufrastbar	www.wago.com/248-501/000-006
	Art-Nr.: 248-501/000-007 Mini-WSB-Beschriftungskarte; als Karte; nicht dehnbar; unbedruckt; aufrastbar	www.wago.com/248-501/000-007
	Art-Nr.: 248-501/000-012 Mini-WSB-Beschriftungskarte; als Karte; nicht dehnbar; unbedruckt; aufrastbar	www.wago.com/248-501/000-012
	Art-Nr.: 248-501/000-017 Mini-WSB-Beschriftungskarte; als Karte; nicht dehnbar; unbedruckt; aufrastbar	www.wago.com/248-501/000-017
	Art-Nr.: 248-501/000-023 Mini-WSB-Beschriftungskarte; als Karte; nicht dehnbar; unbedruckt; aufrastbar	www.wago.com/248-501/000-023
	Art-Nr.: 248-501/000-024 Mini-WSB-Beschriftungskarte; als Karte; nicht dehnbar; unbedruckt; aufrastbar	www.wago.com/248-501/000-024
	Art-Nr.: 793-501 WMB-Beschriftungskarte; als Karte; nicht dehnbar; unbedruckt; aufrastbar	www.wago.com/793-501
	Art-Nr.: 793-501/000-002 WMB-Beschriftungskarte; als Karte; nicht dehnbar; unbedruckt; aufrastbar	www.wago.com/793-501/000-002
	Art-Nr.: 793-501/000-005 WMB-Beschriftungskarte; als Karte; nicht dehnbar; unbedruckt; aufrastbar	www.wago.com/793-501/000-005



Art-Nr.: 793-501/000-006
WMB-Beschriftungskarte; als Karte; nicht dehnbar; unbedruckt; aufrastbar

www.wago.com/793-501/000-006



Art-Nr.: 793-501/000-007
WMB-Beschriftungskarte; als Karte; nicht dehnbar; unbedruckt; aufrastbar

www.wago.com/793-501/000-007



Art-Nr.: 793-501/000-012
WMB-Beschriftungskarte; als Karte; nicht dehnbar; unbedruckt; aufrastbar

www.wago.com/793-501/000-012



Art-Nr.: 793-501/000-017
WMB-Beschriftungskarte; als Karte; nicht dehnbar; unbedruckt; aufrastbar

www.wago.com/793-501/000-017



Art-Nr.: 793-501/000-023
WMB-Beschriftungskarte; als Karte; nicht dehnbar; unbedruckt; aufrastbar

www.wago.com/793-501/000-023



Art-Nr.: 793-501/000-024
WMB-Beschriftungskarte; als Karte; nicht dehnbar; unbedruckt; aufrastbar

www.wago.com/793-501/000-024



Art-Nr.: 793-5501
WMB-Beschriftungskarte; als Karte; für Klemmenbreite 5 - 17,5 mm; dehnbar 5 - 5,2 mm; unbedruckt; aufrastbar

www.wago.com/793-5501



Art-Nr.: 793-5501/000-002
WMB-Beschriftungskarte; als Karte; für Klemmenbreite 5 - 17,5 mm; dehnbar 5 - 5,2 mm; unbedruckt; aufrastbar

www.wago.com/793-5501/000-002



Art-Nr.: 793-5501/000-005
WMB-Beschriftungskarte; als Karte; dehnbar 5 - 5,2 mm; unbedruckt; aufrastbar

www.wago.com/793-5501/000-005



Art-Nr.: 793-5501/000-006
WMB-Beschriftungskarte; als Karte; dehnbar 5 - 5,2 mm; unbedruckt; aufrastbar

www.wago.com/793-5501/000-006



Art-Nr.: 793-5501/000-007
WMB-Beschriftungskarte; als Karte; dehnbar 5 - 5,2 mm; unbedruckt; aufrastbar

www.wago.com/793-5501/000-007



Art-Nr.: 793-5501/000-012
WMB-Beschriftungskarte; als Karte; dehnbar 5 - 5,2 mm; unbedruckt; aufrastbar

www.wago.com/793-5501/000-012



Art-Nr.: 793-5501/000-017
WMB-Beschriftungskarte; als Karte; dehnbar 5 - 5,2 mm; unbedruckt; aufrastbar

www.wago.com/793-5501/000-017



Art-Nr.: 793-5501/000-023
WMB-Beschriftungskarte; als Karte; dehnbar 5 - 5,2 mm; unbedruckt; aufrastbar





www.wago.com/793-5501/000-023















Art-Nr.: 793-5501/000-024
WMB-Beschriftungskarte; als Karte; dehnbar 5 - 5,2 mm; unbedruckt; aufrastbar

www.wago.com/793-5501/000-024

Prüfen und Messen

	Art-Nr.: 2006-511 Modularer TOPJOB®S-Steckverbinder; anreihbar; für Brückerschlitze; 1-polig	www.wago.com/2006-511
	Art-Nr.: 2006-549 Blindmodul; anreihbar; zum Überspringen von z. B. gebrückten Klemmen	www.wago.com/2006-549
	Art-Nr.: 2009-174 Prüfadapter; für Prüfstecker Ø 4 mm; zur Prüfung von TOPJOB®S-Reihenklemmen	www.wago.com/2009-174
	Art-Nr.: 2009-182 Prüfabgriff; für max. 2,5 mm ² ; für den werkzeuglosen Anschluss individueller Prüfleitungen von 0,08 mm - 2,5 mm	www.wago.com/2009-182
	Art-Nr.: 210-136 Prüfstecker; Ø 2 mm; mit 500mm-Leitung	www.wago.com/210-136









Brücker

	Art-Nr.: 2006-402 Kammbrücker; isoliert; 2-fach; Nennstrom 41 A	www.wago.com/2006-402
	Art-Nr.: 2006-403 Kammbrücker; isoliert; 3-fach; Nennstrom 41 A	www.wago.com/2006-403
	Art-Nr.: 2006-404 Kammbrücker; isoliert; 4-fach; Nennstrom 41 A	www.wago.com/2006-404
	Art-Nr.: 2006-405 Kammbrücker; isoliert; 5-fach; Nennstrom 41 A	www.wago.com/2006-405
	Art-Nr.: 2006-405/011-000 Sternbrücker; isoliert; 3-fach (1-3-5); IN = IN Klemme	www.wago.com/2006-405/011-000
	Art-Nr.: 2006-433 Kammbrücker; isoliert; von 1 auf 3; Nennstrom 41 A	www.wago.com/2006-433
	Art-Nr.: 2006-434 Kammbrücker; isoliert; von 1 auf 4; Nennstrom 41 A	www.wago.com/2006-434
	Art-Nr.: 2006-435 Kammbrücker; isoliert; von 1 auf 5; Nennstrom 41 A	www.wago.com/2006-435
	Art-Nr.: 2006-499 Reduzierbrücker; isoliert; von 6/4 mm ² auf 4/2,5/1,5 mm ² ; Nennstrom 32 A	www.wago.com/2006-499
	Art-Nr.: 2016-499 Reduzierbrücker; isoliert; von 16/10 mm ² auf 10/6/4/2,5 mm ² ; Nennstrom 57 A	www.wago.com/2016-499
	Art-Nr.: 210-103 Drahtkettenbrücke; isoliert; 50 Anschlüsse	www.wago.com/210-103
	Art-Nr.: 210-123 Drahtkettenbrücke; isoliert; 50 Anschlüsse	www.wago.com/210-123

Allgemeines Zubehör

	Art-Nr.: 2006-191 Verschlusskappe; Signalverteiler	www.wago.com/2006-191
--	--	--

Tragschiene

	Art-Nr.: 210-112 Stahltragschiene; 35 x 7,5 mm; 1 mm dick; 2 m lang; gelocht; entsprechend EN 60715; Lochbreite 25 mm; Lochabstand 36 mm	www.wago.com/210-112
	Art-Nr.: 210-113 Stahltragschiene; 35 x 7,5 mm; 1 mm dick; 2 m lang; ungelocht; entsprechend EN 60715	www.wago.com/210-113
	Art-Nr.: 210-114 Stahltragschiene; 35 x 15 mm; 1,5 mm dick; 2 m lang; ungelocht; ähnlich EN 60715	www.wago.com/210-114
	Art-Nr.: 210-115 Stahltragschiene; 35 x 7,5 mm; 1 mm dick; 2 m lang; gelocht; entsprechend EN 60715; Lochbreite 18 mm; Lochabstand 25 mm	www.wago.com/210-115
	Art-Nr.: 210-118 Stahltragschiene; 35 x 15 mm; 2,3 mm dick; 2 m lang; ungelocht; entsprechend EN 60715	www.wago.com/210-118
	Art-Nr.: 210-196 Aluminiumtragschiene; 35 x 8,2 mm; 1,6 mm dick; 2 m lang; ungelocht; ähnlich EN 60715	www.wago.com/210-196
	Art-Nr.: 210-197 Stahltragschiene; 35 x 15 mm; 1,5 mm dick; 2 m lang; gelocht; ähnlich EN 60715	www.wago.com/210-197
	Art-Nr.: 210-198 Kupfertragschiene; 35 x 15 mm; 2,3 mm dick; 2 m lang; ungelocht; entsprechend EN 60715	www.wago.com/210-198

Downloads

Dokumentation

Ausschreibungstext

2206-1301		docx 15,2 kB	Download
-----------	--	-----------------	----------

Weitere Informationen

Technische Erläuterungen	Apr 3, 2019	pdf 2,1 MB	Download
--------------------------	-------------	---------------	----------

CAD/CAE - Smart Data

CAD Daten

3D Download 2206-1301			Download
-----------------------	--	--	----------

Änderungen vorbehalten.

WAGO Kontakttechnik GmbH & Co. KG
 Hansastr. 27
 32423 Minden
 Telefon: +49571 887-0
 E-Mail: info.de@wago.com | Web: www.wago.com

Haben Sie Fragen zu unseren Produkten?
 Wir stehen Ihnen telefonisch unter +49 (571) 887-44222 gern zur Verfügung.