

Network cable - NBC-MSD/11,8-939/MSD SCO SI - 1417996

Please be informed that the data shown in this PDF Document is generated from our Online Catalog. Please find the complete data in the user's documentation. Our General Terms of Use for Downloads are valid (<http://phoenixcontact.com/download>)



Network cable, PROFINET CAT5 (100 Mbps), 4-position, PE-X halogen-free, black, shielded, Plug straight M12 SPEEDCON / IP65, coding: D, on Plug straight M12 SPEEDCON / IP65, coding: D, cable length: 11.8 m, Product tested according to customer specification/rail application



Key Commercial Data

Packing unit	1 pc
Minimum order quantity	50 pc
GTIN	 4 055626 130057
GTIN	4055626130057
Weight per Piece (excluding packing)	805.990 g
Custom tariff number	85444290
Country of origin	Poland
Note	Made to Order (non-returnable)

Technical data

Dimensions

Length of cable	11.8 m
-----------------	--------

General data

Note	The cable is 100% electrically tested for continuity.
Rated current at 40°C	4 A
Rated voltage	48 V AC 60 V DC
Number of positions	4
Signal type/category	PROFINET CAT5 (IEC 11801), 100 Mbps
Standards/regulations	M12 connector IEC 61076-2-101
Overvoltage category	II
Degree of pollution	3

Characteristics head 1

Network cable - NBC-MSD/11,8-939/MSD SCO SI - 1417996

Technical data

Characteristics head 1

Head type	Plug straight M12 SPEEDCON / IP65
No. of positions (pin connector pattern)	4
Coding	D (Data)
Color	black
Material (component)	CuSn (Contact)
	Ni/Au (Contact surface)
	PA (Contact carriers)
	TPU, hardly inflammable, self-extinguishing (Grip)
	Zinc die-cast, nickel-plated (Screw connection)
Shielded	yes
Insulation resistance	≥ 100 MΩ
Test voltage	500 V DC ±15 V DC (for 60 s, insulation resistance according to DIN EN 60512-3-1)
	1.4 kV AC (for 60 s, dielectric strength according to DIN EN 60512-4-1)
Insertion/withdrawal cycles	≥ 100 (Quantity: 500 with Phoenix Contact mating connector)
Torque	0.4 Nm
Ambient temperature (operation)	-40 °C ... 90 °C
Weight	10 g ±5 g

Characteristics head 2

Head type	Plug straight M12 SPEEDCON / IP65
No. of positions (pin connector pattern)	4
Coding	D (Data)
Color	black
Material (component)	CuSn (Contact)
	Ni/Au (Contact surface)
	PA (Contact carriers)
	TPU, hardly inflammable, self-extinguishing (Grip)
	Zinc die-cast, nickel-plated (Screw connection)
Shielded	yes
Insulation resistance	≥ 100 MΩ
Test voltage	500 V DC ±15 V DC (for 60 s, insulation resistance according to DIN EN 60512-3-1)
	1.4 kV AC (for 60 s, dielectric strength according to DIN EN 60512-4-1)
Insertion/withdrawal cycles	≥ 100 (Quantity: 500 with Phoenix Contact mating connector)
Torque	0.4 Nm
Ambient temperature (operation)	-40 °C ... 90 °C
Weight	10 g ±5 g

Standards and Regulations

Standard designation	M12 connector
Standards/regulations	IEC 61076-2-101

Network cable - NBC-MSD/11,8-939/MSD SCO SI - 1417996

Technical data

Standards and Regulations

Flammability rating according to UL 94	V0
--	----

Cable

Cable type	PROFINET railway applications
Cable type (abbreviation)	939
Signal type/category	PROFINET CAT5 (IEC 11801), 100 Mbps
Cable structure	1x4xAWG22/7; SF/TQ
Conductor cross section	4x 0.34 mm ²
AWG signal line	22
Conductor structure signal line	7x 0.25 mm
Core diameter including insulation	1.4 mm ±0.1 mm
Wire colors	white-blue, orange-yellow
Overall twist	Star quad
Shielding	Aluminum-lined polyester foil, tinned copper braided shield
External sheath, color	black
Outer sheath thickness	1 mm
External cable diameter D	6.6 mm ±0.2 mm
Minimum bending radius, fixed installation	5 x D
Minimum bending radius, flexible installation	6 x D
Tensile strength GRP	≤ 60 N (temporary) ≤ 15 N (Permanent)
Cable weight	71 kg/km
Outer sheath, material	PE-X
Material conductor insulation	Cell PE
Conductor material	Tin-plated Cu litz wires
Insulation resistance	≥ 5 GΩ*km
Conductor resistance	≤ 54.4 Ω/km
Cable capacity	44 nF/km (core-core)
Wave impedance	100 Ω ±5 Ω (f = 100 MHz)
Near end crosstalk attenuation (NEXT)	76 dB (with 1 MHz) 71 dB (at 4 MHz) 64 dB (at 10 MHz) 60 dB (at 16 MHz) 56 dB (at 31.25 MHz) 52 dB (at 62.5 MHz) 48 dB (at 100 MHz) 45 dB (at 155 MHz) 42 dB (at 200 MHz)
Power-summated near end crosstalk attenuation (PSNEXT)	73 dB (with 1 MHz) 68 dB (at 4 MHz) 61 dB (at 10 MHz)

Network cable - NBC-MSD/11,8-939/MSD SCO SI - 1417996

Technical data

Cable

	57 dB (at 16 MHz)
	53 dB (at 31.25 MHz)
	49 dB (at 62.5 MHz)
	45 dB (at 100 MHz)
	42 dB (at 155 MHz)
	39 dB (at 200 MHz)
Attenuation	1.5 dB (with 1 MHz)
	3.3 dB (at 4 MHz)
	5.3 dB (at 10 MHz)
	6.9 dB (at 16 MHz)
	9.9 dB (at 31.25 MHz)
	14.5 dB (at 62.5 MHz)
	18.8 dB (at 100 MHz)
	23.6 dB (at 155 MHz)
	27.3 dB (at 200 MHz)
Return loss (RL)	25 dB (with 1 MHz)
	25 dB (at 4 MHz)
	28 dB (at 10 MHz)
	28 dB (at 16 MHz)
	27 dB (at 31.25 MHz)
	26 dB (at 62.5 MHz)
	25 dB (at 100 MHz)
	25 dB (at 155 MHz)
	23 dB (at 200 MHz)
Signal speed	0.75 c
Signal runtime	4.4 ns/m
Shield attenuation	60 dB (up to 1000 MHz)
Coupling resistance	< 13.00 mΩ/m (f = 1 MHz)
	< 8.00 mΩ/m (f = 10 MHz ... 100 MHz)
Cable impedance	100 Ω ±15 Ω (f = 0.5 MHz ... 3 MHz)
Nominal voltage, cable	125 V
Test voltage Core/Core	1000 V AC (50 Hz, 1 min.)
Test voltage Core/Shield	1000 V AC (50 Hz, 1 min.)
Fire protection in rail vehicles	BS 6853 (Internal cable Ia, Ib, II/external cable Ia, Ib, II)
	DIN 5510-2 (Fire protection level 1, 2, 3, 4)
	EN 45545-2 (Risk level HL1 - HL3)
	EN 50306-4
	NF F16-101 (Classification C/F1)
	NF F16-101 (Internal cable A1, A2, B/external cable A1, A2, B)
	NFPA 130

Network cable - NBC-MSD/11,8-939/MSD SCO SI - 1417996

Technical data

Cable

	PN-K-02511
	UIC 564-2 (Class A)
Flame resistance	according to EN 60332-1-2
	according to EN 50266-2-5
	according to ISO 14572 5.21 (UN ECE-R 118.01)
Halogen-free	According to EN 50267-2-1
	according to EN 60684-2
Resistance to oil	according to EN 60684-2, 72 h at 100 °C, IRM 902
Other resistance	Resistant to fuel according to EN 60684-2, 72 h at 100 °C, IRM 903
	Resistant to ozone according to EN 50306-4, 72 h at 40 °C, procedure B, volume concentration 200×10^{-6}
Concentration of fumes	EN 61034-2
Ambient temperature (operation)	-40 °C ... 85 °C (cable, fixed installation)
	-25 °C ... 70 °C (cable, flexible installation)

Environmental Product Compliance

China RoHS	Environmentally friendly use period: unlimited = EFUP-e
	No hazardous substances above threshold values

Drawings

Dimensional drawing

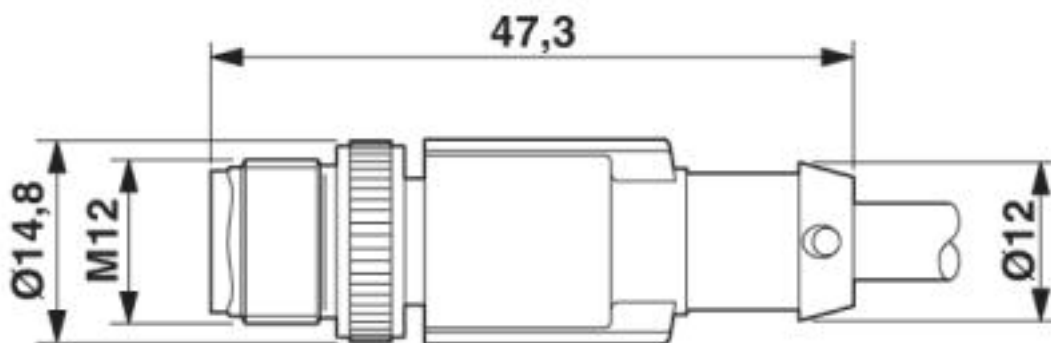

M12 SPEEDCON plug, straight, shielded

Network cable - NBC-MSD/11,8-939/MSD SCO SI - 1417996

Circuit diagram

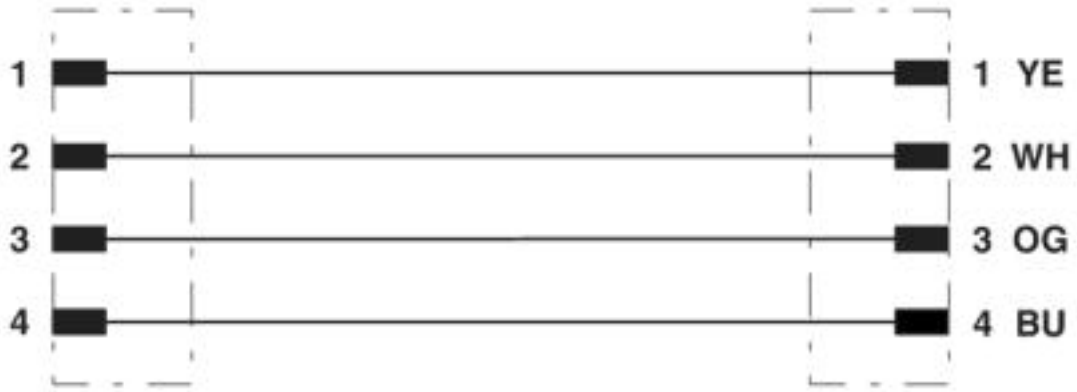

Contact assignment of the M12 plugs

Schematic diagram

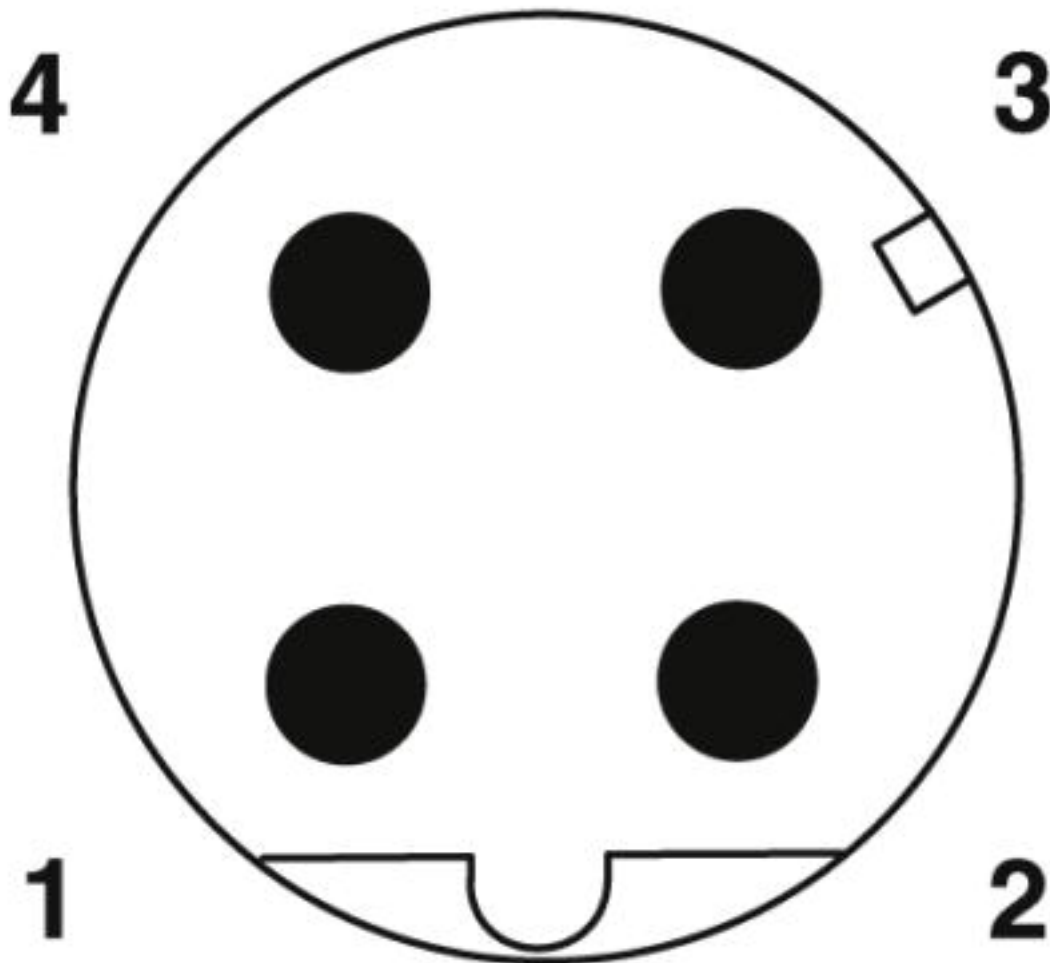

Pin assignment M12 male connector, 4-pos., D-coded, male side

Network cable - NBC-MSD/11,8-939/MSD SCO SI - 1417996

Cable cross section

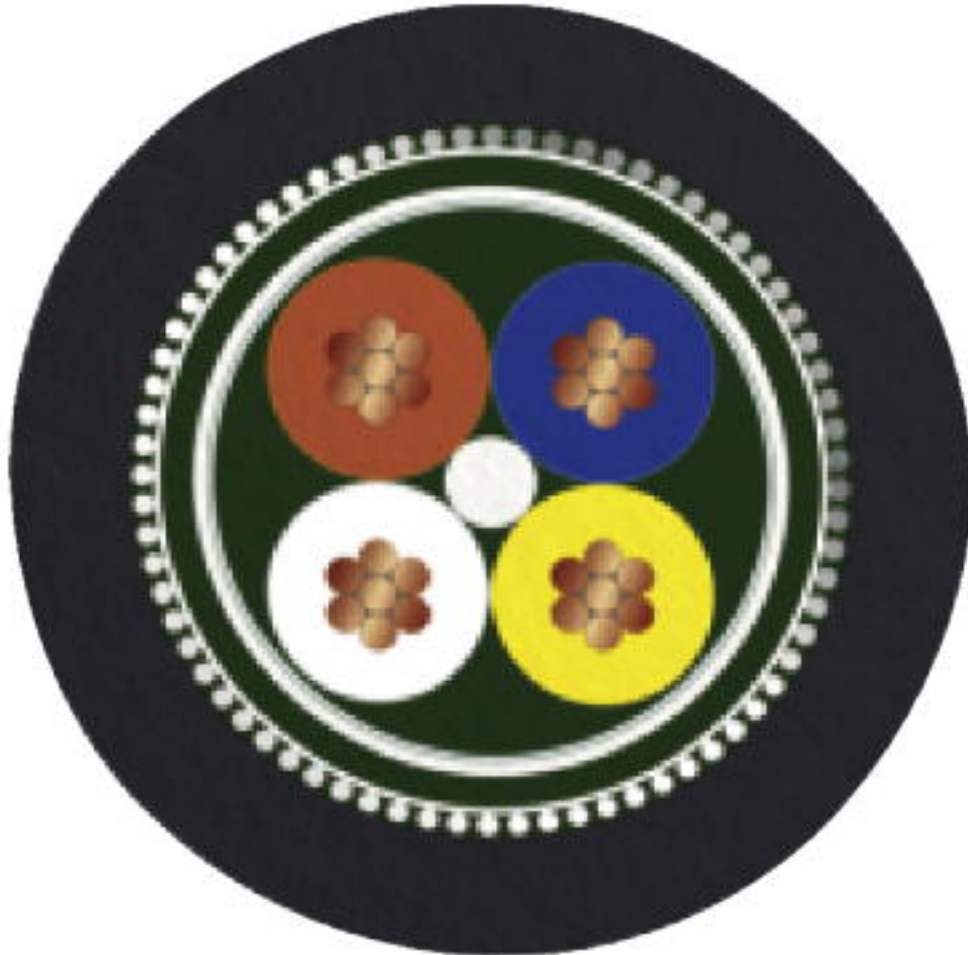

PROFINET railway applications [939]

Classifications

eCl@ss

eCl@ss 5.1	27250107
eCl@ss 6.0	27279200
eCl@ss 7.0	27279218
eCl@ss 8.0	27279218
eCl@ss 9.0	27060311

ETIM

ETIM 5.0	EC001855
ETIM 6.0	EC001855
ETIM 7.0	EC001855

Network cable - NBC-MSD/11,8-939/MSD SCO SI - 1417996

Classifications

UNSPSC

UNSPSC 13.2	31251501
UNSPSC 19.0	31251501
UNSPSC 20.0	31251501
UNSPSC 21.0	31251501