

Bus system cable - SAC-2P-M12MSB/5-915/M12FSB VA - 1402381

Please be informed that the data shown in this PDF Document is generated from our Online Catalog. Please find the complete data in the user's documentation. Our General Terms of Use for Downloads are valid (<http://phoenixcontact.com/download>)



Bus system cable, PROFIBUS, 2-position, PUR/PVC, blue, shielded, Plug straight M12, B-coded, on Socket straight M12, B-coded, cable length: 5 m

As illustrated but with VA knurl



Key Commercial Data

Packing unit	1 pc
Minimum order quantity	50 pc
GTIN	 4 046356 610834
GTIN	4046356610834
Weight per Piece (excluding packing)	405.000 g
Custom tariff number	85444290
Country of origin	Poland
Note	Made to Order (non-returnable)

Technical data

Dimensions

Length of cable	5 m
-----------------	-----

Ambient conditions

Ambient temperature (operation)	-25 °C ... 90 °C (Plug / socket)
Degree of protection	IP65
	IP67
	IP68
	IP69K

General

Rated current at 40°C	4 A
Rated voltage	48 V AC
	60 V DC

Bus system cable - SAC-2P-M12MSB/5-915/M12FSB VA - 1402381

Technical data

General

Number of positions	2
Color handle area	black
Insulation resistance	≥ 100 MΩ
Coding	B - inverse
Signal type/category	PROFIBUS
Status display	No
Overvoltage category	II
Degree of pollution	3
Insertion/withdrawal cycles	≥ 100
Torque	0.4 Nm (M12 connector)

Material

Flammability rating according to UL 94	V0
Contact material	CuSn
Contact surface material	Ni/Au
Contact carrier material	PA 6.6
Material of grip body	TPU, hardly inflammable, self-extinguishing
Material, knurls	Stainless steel
Sealing material	NBR

Pin assignment

Contact Color (signal designation) Contact (optional)	2 (Plug) GN (A cable) 2 (Socket)
	4 (Plug) RD (B cable) 4 (Socket)

Standards and Regulations

Flammability rating according to UL 94	V0
--	----

Cable

Cable type	PROFIBUS
Cable type (abbreviation)	915
Cable structure	1x2xAWG24/19
Conductor cross section	2x 0.25 mm ²
AWG signal line	24
Conductor structure signal line	19x 0.14 mm
Core diameter including insulation	2.56 mm
Wire colors	Red, green
Overall twist	2 wires, twisted
Shielding	Aluminum-coated foil, tinned copper braided shield
Optical shield covering	70 %
External sheath, color	blue
Outer sheath thickness	approx. 0.8 mm
External cable diameter D	8 mm ±0.4 mm
Minimum bending radius, flexible installation	5 x D

Bus system cable - SAC-2P-M12MSB/5-915/M12FSB VA - 1402381

Technical data

Cable

Number of bending cycles	3000000
Bending radius	60 mm
Acceleration	4 m/s ²
Cable weight	74 kg/km
Tensile strength GRP	≤ 100 N
Outer sheath, material	PUR
Material, inner sheath	PVC
Material conductor insulation	Foamed PE
Conductor material	Bare Cu litz wires
Insulation resistance	≥ 16 GΩ*km
Working capacitance	28 nF (at 1 kHz)
Nominal voltage, cable	≤ 100 V
Test voltage Core/Core	3600 V DC
Flame resistance	according to IEC 60332-1
Resistance to oil	Resistant to mineral oils and grease
Ambient temperature (operation)	-40 °C ... 80 °C (cable, flexible installation)

Environmental Product Compliance

China RoHS	Environmentally friendly use period: unlimited = EFUP-e
	No hazardous substances above threshold values

Drawings

Dimensional drawing

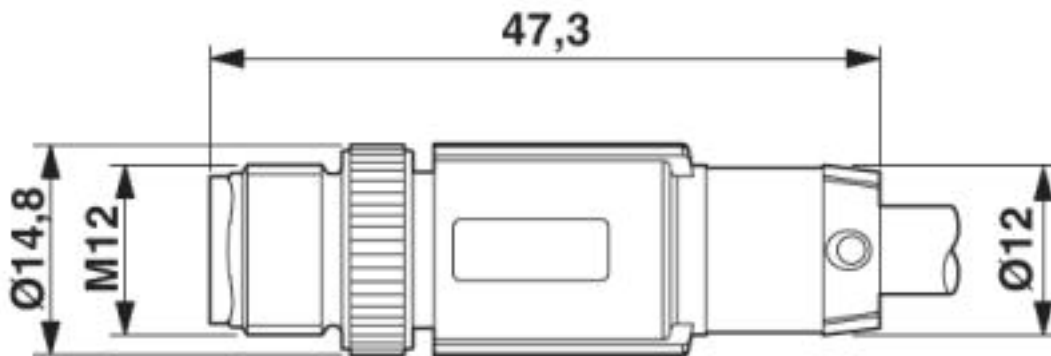

Plug, M12 x 1, straight, shielded

Bus system cable - SAC-2P-M12MSB/5-915/M12FSB VA - 1402381

Dimensional drawing

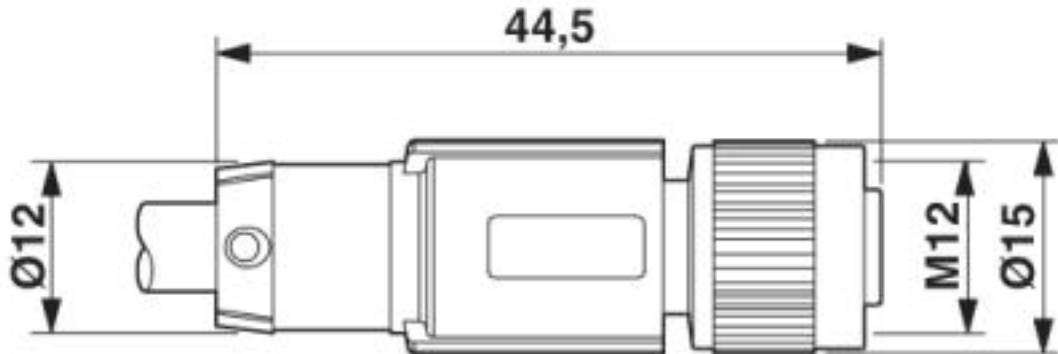

M12 x 1 socket, straight, shielded

Circuit diagram

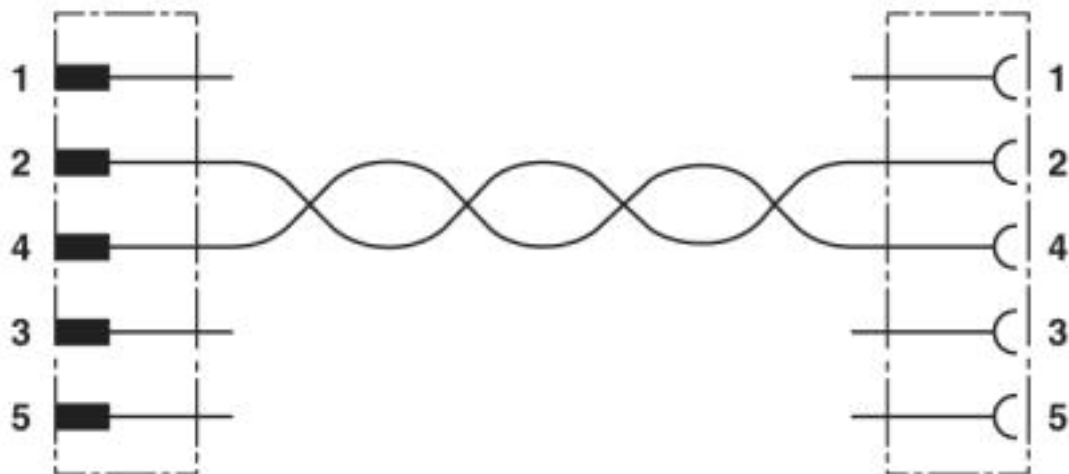

Bus system cable - SAC-2P-M12MSB/5-915/M12FSB VA - 1402381

Schematic diagram

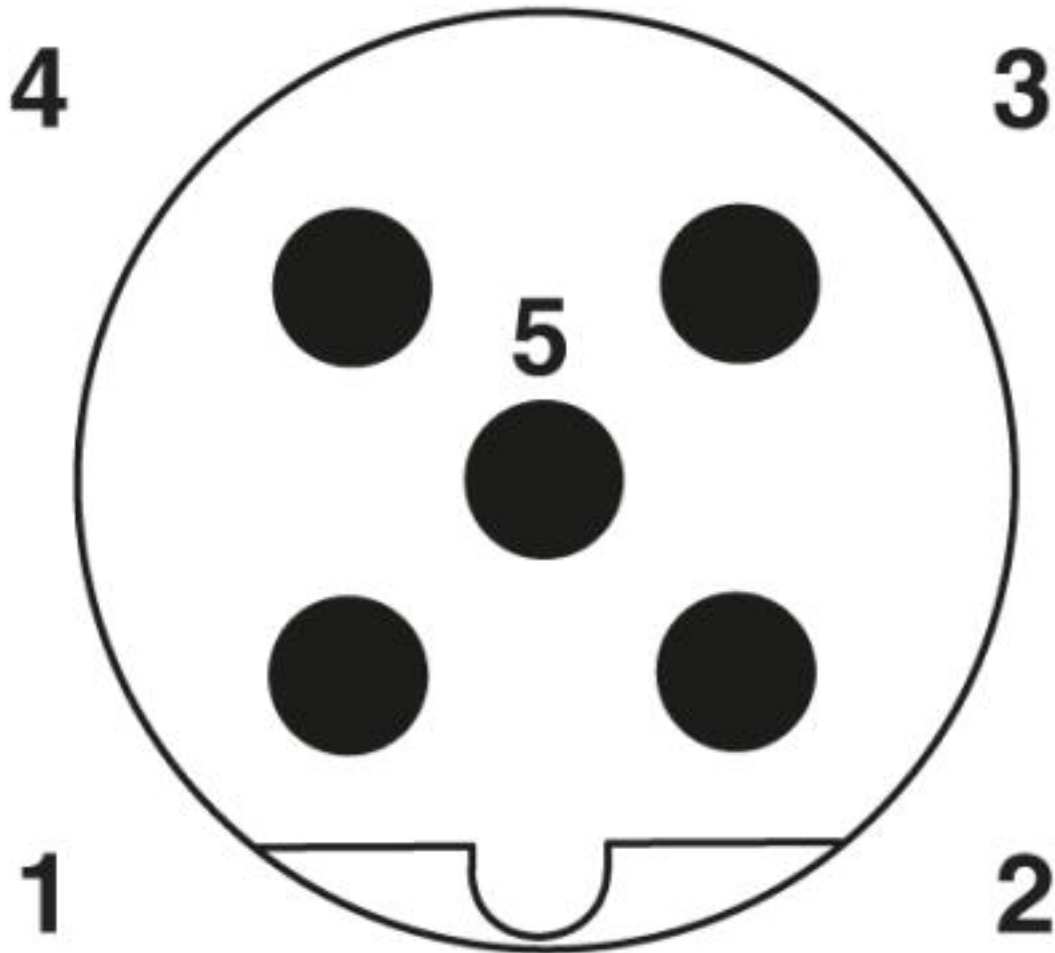

Pin assignment M12 male connector, 5-pos., B-coded, male side

Bus system cable - SAC-2P-M12MSB/5-915/M12FSB VA - 1402381

Schematic diagram

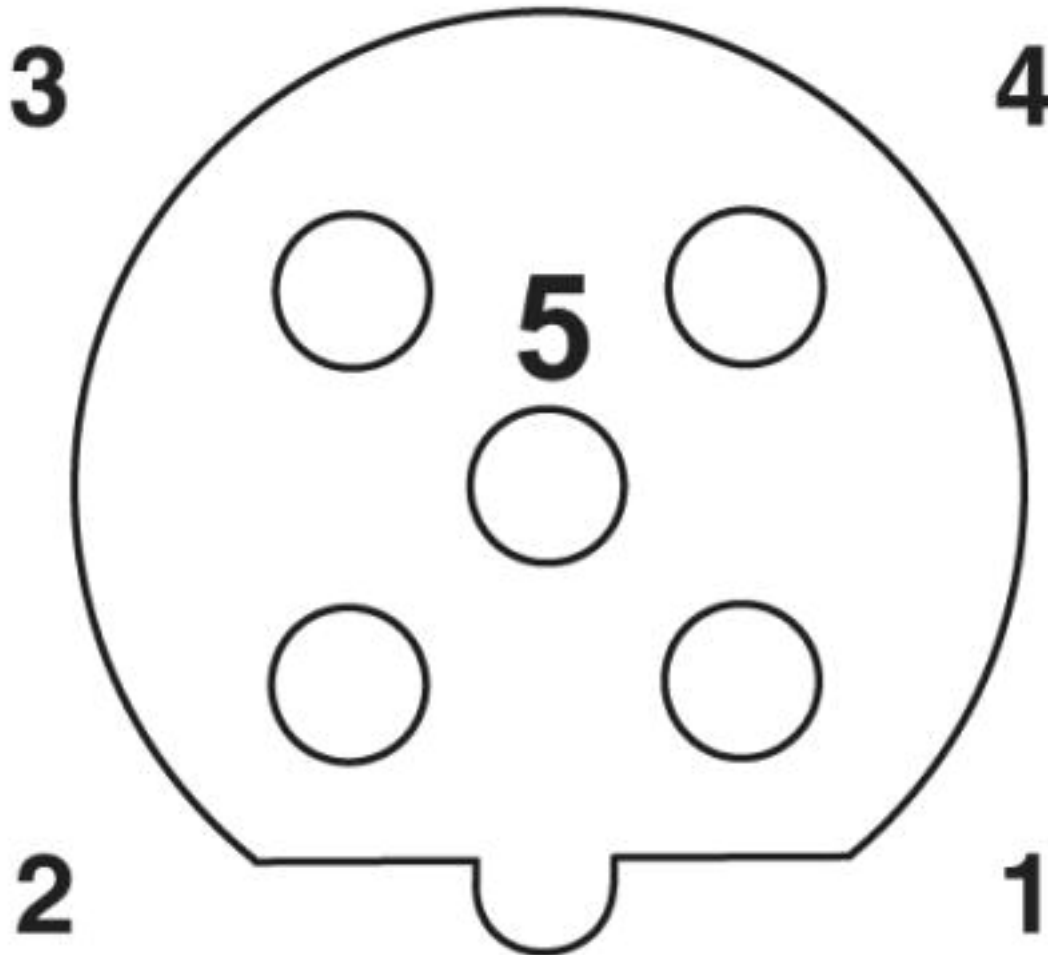

Pin assignment M12 socket, 5-pos., B-coded, female side

Classifications

eCl@ss

eCl@ss 4.0	27060300
eCl@ss 4.1	27060300
eCl@ss 5.0	27061800
eCl@ss 5.1	27061800
eCl@ss 6.0	27279200
eCl@ss 7.0	27279218
eCl@ss 8.0	27279218
eCl@ss 9.0	27060311

ETIM

ETIM 3.0	EC001855
----------	----------

Bus system cable - SAC-2P-M12MSB/5-915/M12FSB VA - 1402381

Classifications

ETIM

ETIM 4.0	EC001855
ETIM 5.0	EC001855
ETIM 6.0	EC001855
ETIM 7.0	EC001855

UNSPSC

UNSPSC 6.01	31251501
UNSPSC 7.0901	31251501
UNSPSC 11	31251501
UNSPSC 12.01	31251501
UNSPSC 13.2	31251501
UNSPSC 19.0	31251501
UNSPSC 20.0	31251501
UNSPSC 21.0	31251501

Approvals

Approvals

Approvals

EAC

Ex Approvals

Approval details

EAC		RU C- DE.BL08.B.00286
-----	---	--------------------------