

Single relay - REL-OR2/LDP-220DC/2X21 - 2907026

Please be informed that the data shown in this PDF Document is generated from our Online Catalog. Please find the complete data in the user's documentation. Our General Terms of Use for Downloads are valid (<http://phoenixcontact.com/download>)



Plug-in octal relay with power contacts, 2 change-over contacts, test key, mechanical switch position display, coil voltage: 220 V DC, response voltage at 23 °C without pre-excitation $\geq 60\% \dots 80\%$ of the rated voltage ($\geq 132\text{ V DC} \dots \leq 176\text{ V DC}$)



Key Commercial Data

Packing unit	10 pc
GTIN	
GTIN	4055626159942
Weight per Piece (excluding packing)	91.530 g
Custom tariff number	85364900
Country of origin	Poland

Technical data

Dimensions

Width	35 mm
Height	35 mm
Depth	54.4 mm

Ambient conditions

Ambient temperature (operation)	-40 °C ... 70 °C
Ambient temperature (storage/transport)	-40 °C ... 85 °C
Degree of protection	RT I

Coil side

Nominal input voltage U_N	220 V DC
Input voltage range in reference to U_N	see diagram
Typical input current at U_N	8 mA
Typical response time	18 ms
Typical release time	7 ms

Single relay - REL-OR2/LDP-220DC/2X21 - 2907026

Technical data

Coil side

Protective circuit	Damping diode
Status display	Yellow LED
Power dissipation for nominal condition	1.76 W

Contact side

Contact type	2 PDT
Type of switch contact	Single contact
Contact material	AgNi
Maximum switching voltage	250 V AC/DC
Minimum switching voltage	10 V (At 24 mA)
Min. switching current	10 mA (at 24 V)
Maximum inrush current	30 A (20 ms, N/O contact)
Limiting continuous current	10 A
Interrupting rating (ohmic load) max.	240 W (at 24 V DC)
	124 W (at 48 V DC)
	108 W (at 60 V DC)
	52 W (at 110 V DC)
	48 W (at 220 V DC)
	2500 VA (for 250 V AC)
Switching capacity min.	0.24 W
Switching capacity	2 A (at 24 V, DC13)
	1.5 A (at 230 V, AC15)

General

Test voltage relay winding/relay contact	2.5 kV _{rms} (50 Hz, 1 min.)
Test voltage PDT/PDT	2 kV _{rms} (50 Hz, 1 min.)
Operating mode	100% operating factor
Mechanical service life	1x 10 ⁷ cycles, approximately
Mounting position	any

Connection data

Connection method	Plug connection
-------------------	-----------------

Standards and Regulations

Standards/regulations	IEC 60664
	IEC 61810
Rated insulation voltage	250 V AC
Rated surge voltage	4 kV
Insulation	Basic insulation
Pollution degree	3
Overvoltage category	III

Environmental Product Compliance

Single relay - REL-OR2/LDP-220DC/2X21 - 2907026

Technical data

Environmental Product Compliance

China RoHS	Environmentally Friendly Use Period = 50
	For details about hazardous substances go to tab "Downloads", Category "Manufacturer's declaration"

Drawings

Diagram

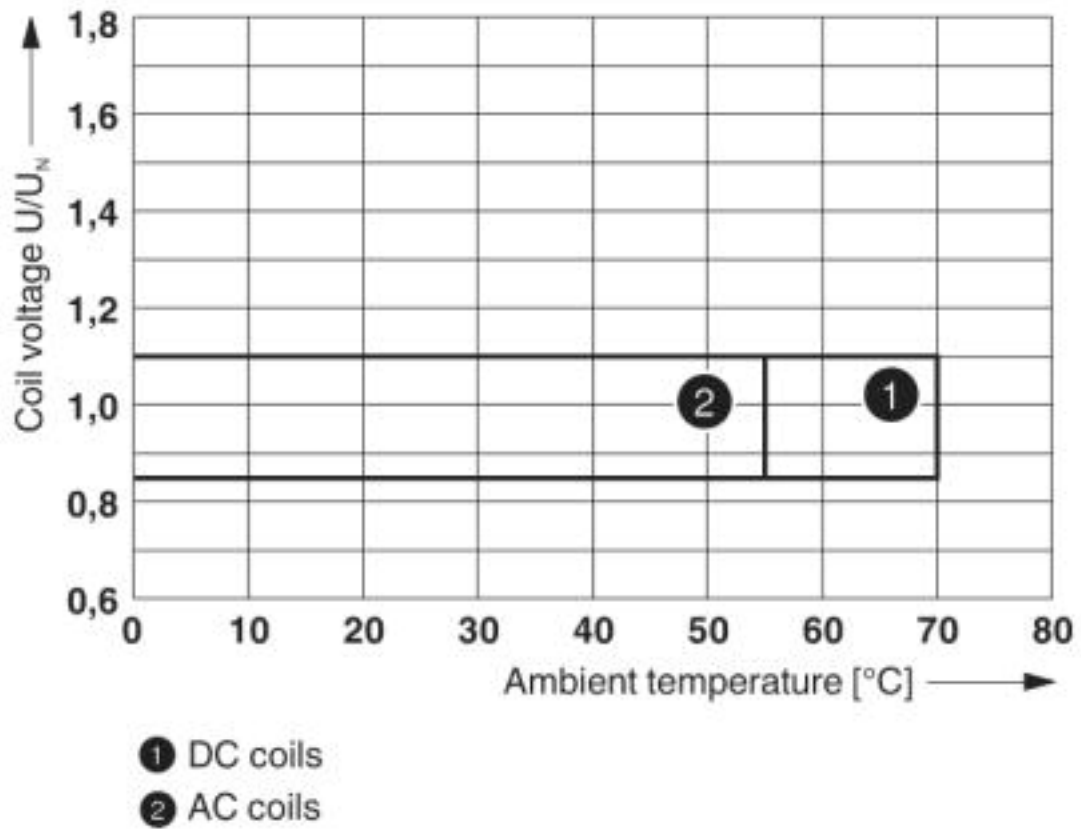

Operating voltage range

Single relay - REL-OR2/LDP-220DC/2X21 - 2907026

Circuit diagram

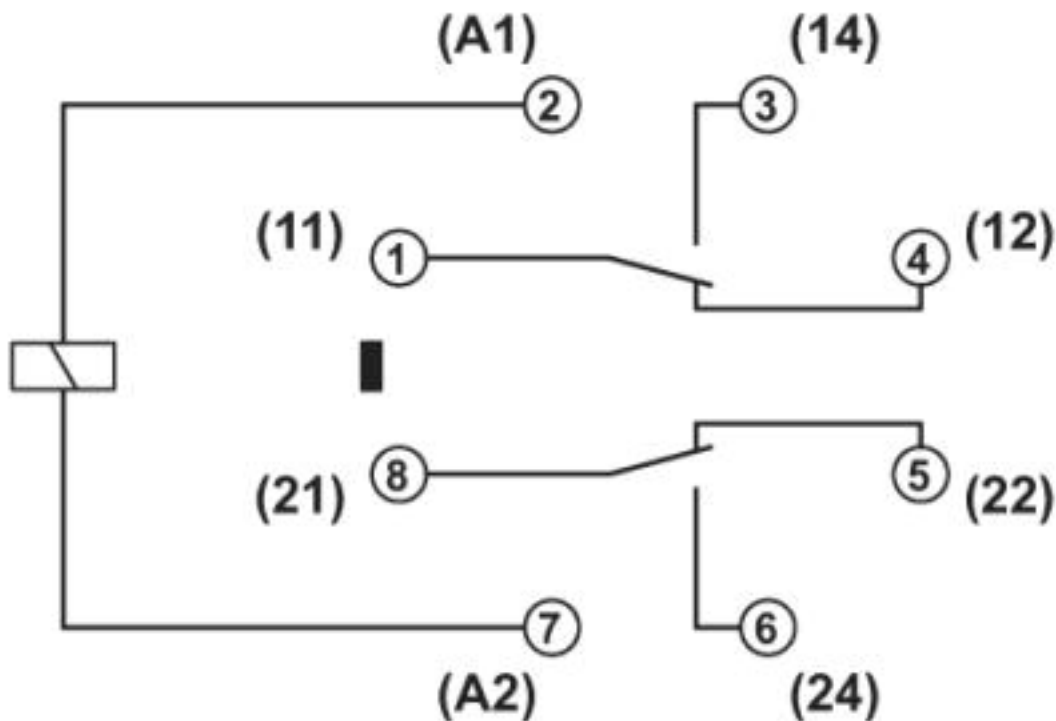

Classifications

eCl@ss

eCl@ss 4.0	27371100
eCl@ss 4.1	27371100
eCl@ss 5.0	27371600
eCl@ss 5.1	27371600
eCl@ss 6.0	27371600
eCl@ss 7.0	27371601
eCl@ss 8.0	27371601
eCl@ss 9.0	27371601

ETIM

ETIM 2.0	EC001437
ETIM 3.0	EC001437
ETIM 4.0	EC001437
ETIM 5.0	EC001437
ETIM 6.0	EC001437
ETIM 7.0	EC001437

UNSPSC

UNSPSC 6.01	30211916
-------------	----------

Single relay - REL-OR2/LDP-220DC/2X21 - 2907026

Classifications

UNSPSC

UNSPSC 7.0901	39121515
UNSPSC 11	39121515
UNSPSC 12.01	39121515
UNSPSC 13.2	39122334
UNSPSC 18.0	39122334
UNSPSC 19.0	39122334
UNSPSC 20.0	39122334
UNSPSC 21.0	39122334

Approvals





Approvals

Approvals

CSA / UL Recognized / cUL Recognized / EAC / EAC / cULus Recognized

Ex Approvals

Approval details

CSA		http://www.csagroup.org/services-industries/product-listing/	2554095
UL Recognized		http://database.ul.com/cgi-bin/XYV/template/LISEXT/1FRAME/index.htm	FILE E 172140
cUL Recognized		http://database.ul.com/cgi-bin/XYV/template/LISEXT/1FRAME/index.htm	FILE E 172140
EAC			TR_TS_D_00573_c
EAC			TR_TS_S_00010_c

Single relay - REL-OR2/LDP-220DC/2X21 - 2907026

Approvals

cULus Recognized



Accessories

Additional products

Relay base - RIF-3-BPT/2X21 - 2900937



RIF-3... relay base, for octal relay with 2 PDTs, push-in connection, plug-in option for input/suppressor modules, for mounting on NS 35/7,5

Relay base - RIF-3-BSC/2X21 - 2900935



RIF-3... relay base, for octal relay with 2 changeover contacts, screw connection, plug-in option for input/interference suppression modules, for mounting on NS 35/7,5