

Relay Module - EMG 10-REL/KSR-G 24/21-LCU AU - 2940388

Please be informed that the data shown in this PDF Document is generated from our Online Catalog. Please find the complete data in the user's documentation. Our General Terms of Use for Downloads are valid (<http://phoenixcontact.com/download>)



Relay module, with soldered-in miniature switching relay, gold contact for small loads, 1 PDT, input voltage 24 V DC, design rotated by 180°

Your advantages

- Integrated input circuit and interference suppression circuit



Key Commercial Data

Packing unit	10 pc
GTIN	 4 017918 104498
GTIN	4017918104498
Weight per Piece (excluding packing)	41.360 g
Custom tariff number	85364190
Country of origin	Germany
Note	Made to Order (non-returnable)

Technical data

Note

Utilization restriction	EMC: class A product, see manufacturer's declaration in the download area
-------------------------	---------------------------------------------------------------------------

Dimensions

Width	10.6 mm
Height	75 mm
Depth	62.5 mm

Ambient conditions

Ambient temperature (operation)	-20 °C ... 40 °C
Ambient temperature (storage/transport)	-20 °C ... 70 °C

Coil side

Relay Module - EMG 10-REL/KSR-G 24/21-LCU AU - 2940388

Technical data

Coil side

Nominal input voltage U_N	24 V DC
Input voltage range in reference to U_N	0.8 ... 1.1
Typical input current at U_N	21 mA
Typical response time	7 ms
Typical release time	11 ms
Protective circuit	Reverse polarity protection Polarity protection diode Free-wheeling diode Damping diode
Operating voltage display	Yellow LED
Power dissipation for nominal condition	0.5 W

Contact side

Contact type	Double contact, 1 PDT
Type of switch contact	Double contact
Contact material	AgPd60, hard gold-plated
Maximum switching voltage	30 V AC 36 V DC
Maximum inrush current	0.2 A
Limiting continuous current	0.5 A
Interrupting rating (ohmic load) max.	5 W (at 24 V DC)

Contact side (with destroyed gold layer)

Note	the following values are applicable if a gold layer is destroyed
Maximum switching voltage	125 V AC 150 V DC
Limiting continuous current	2 A
Maximum inrush current	2 A
Interrupting rating (ohmic load) max.	29 W (at 24 V DC) 29 W (at 48 V DC) 29 W (at 60 V DC)

General

Test voltage relay winding/relay contact	4 kV AC (50 Hz, 1 min.)
Operating mode	100% operating factor
Mechanical service life	approx. 2×10^7 cycles
Mounting position	any
Assembly instructions	In rows with zero spacing

Connection data

Connection name	Coil side
Connection method	Screw connection
Stripping length	8 mm
Screw thread	M3
Conductor cross section solid	0.2 mm ² ... 4 mm ²

Relay Module - EMG 10-REL/KSR-G 24/21-LCU AU - 2940388

Technical data

Connection data

Conductor cross section flexible	0.2 mm ² ... 2.5 mm ²
Conductor cross section AWG	24 ... 12

Connection data 2

Connection name	Contact side
Connection method	Screw connection
Stripping length	8 mm
Screw thread	M3
Conductor cross section solid	0.2 mm ² ... 4 mm ²
Conductor cross section flexible	0.2 mm ² ... 2.5 mm ²
Conductor cross section AWG	24 ... 12

Standards and Regulations

Connection in acc. with standard	CUL
Standards/regulations	IEC 60664
	EN 50178
Insulation	Basic insulation
Pollution degree	2
Overvoltage category	III

Environmental Product Compliance

	Lead 7439-92-1
China RoHS	Environmentally Friendly Use Period = 50
	For details about hazardous substances go to tab "Downloads", Category "Manufacturer's declaration"

Drawings

Relay Module - EMG 10-REL/KSR-G 24/21-LCU AU - 2940388

Connection diagram



Circuit diagram

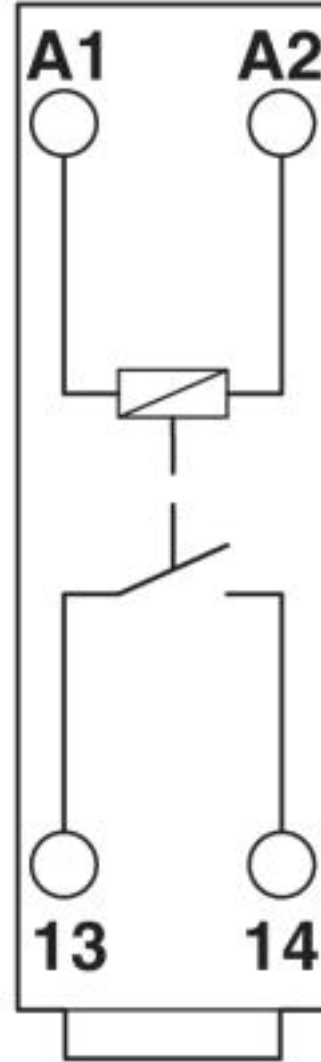

Relay Module - EMG 10-REL/KSR-G 24/21-LCU AU - 2940388

Circuit diagram

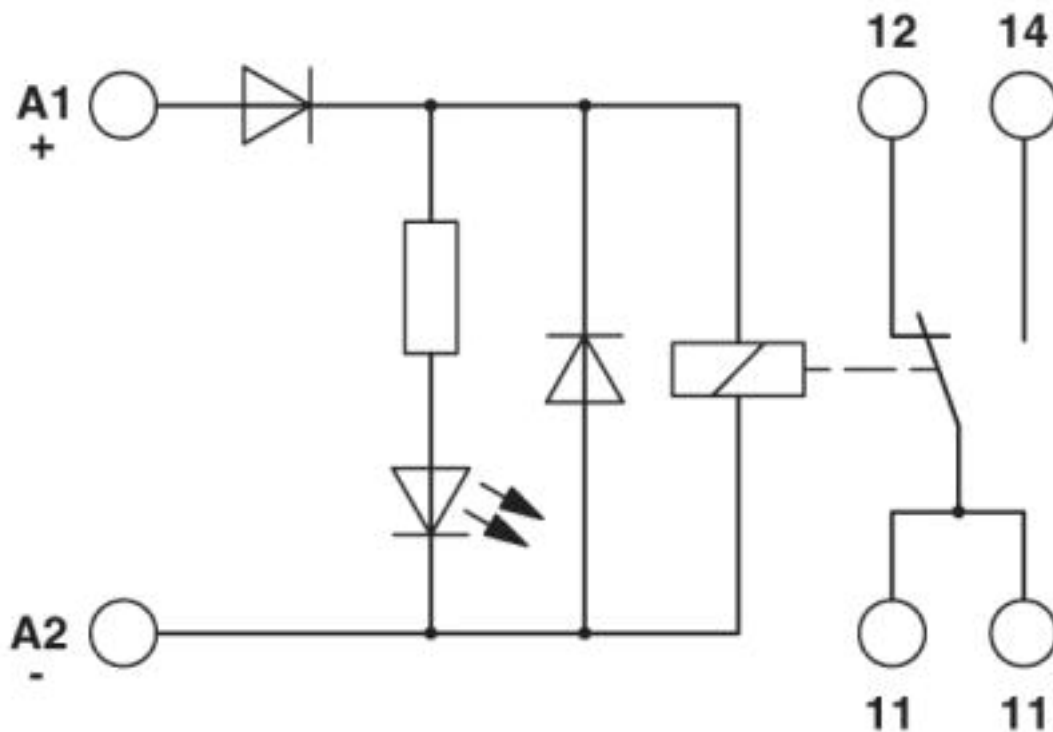

Classifications

eCl@ss

eCl@ss 4.0	27371100
eCl@ss 4.1	27371100
eCl@ss 5.0	27371600
eCl@ss 5.1	27371600
eCl@ss 6.0	27371600
eCl@ss 7.0	27371601
eCl@ss 8.0	27371601
eCl@ss 9.0	27371601

ETIM

ETIM 2.0	EC001437
ETIM 3.0	EC001437
ETIM 4.0	EC001437
ETIM 5.0	EC001437
ETIM 6.0	EC001437
ETIM 7.0	EC001437

UNSPSC

UNSPSC 6.01	30211916
-------------	----------

Relay Module - EMG 10-REL/KSR-G 24/21-LCU AU - 2940388

Classifications

UNSPSC

UNSPSC 7.0901	39121515
UNSPSC 11	39121515
UNSPSC 12.01	39121515
UNSPSC 13.2	39122334
UNSPSC 18.0	39122334
UNSPSC 19.0	39122334
UNSPSC 20.0	39122334
UNSPSC 21.0	39122334

Approvals





Approvals

Approvals

UL Recognized / cUL Recognized / EAC / EAC / cULus Recognized

Ex Approvals

Approval details

UL Recognized		http://database.ul.com/cgi-bin/XYV/template/LISEXT/1FRAME/index.htm	FILE E 238705
cUL Recognized		http://database.ul.com/cgi-bin/XYV/template/LISEXT/1FRAME/index.htm	FILE E 238705
EAC			TR_TS_D_00573_c
EAC			TR_TS_S_00010_c
cULus Recognized			

Relay Module - EMG 10-REL/KSR-G 24/21-LCU AU - 2940388

Accessories

Accessories

Marking material - EMG-SGKS 10 - 2947585



Equipment marker, narrow