

Sensor/actuator box - SACB- 4/3-L-10,0PUR-M8 - 1516027

Please be informed that the data shown in this PDF Document is generated from our Online Catalog. Please find the complete data in the user's documentation. Our General Terms of Use for Downloads are valid (<http://phoenixcontact.com/download>)



Sensor/actuator box, application: Standard, connection method: M8 socket Metal, number of slots: 4, number of positions: 3, coding: A - standard, slot assignment: single, status display: yes, pnp; master cable connection: Fixed connection 180°, PUR/PVC, cable length: 10 m, shielding: no

Your advantages

- Safety in the field, thanks to molded housing and high degree of protection
- Flexible, distributed bundling of signals in one master cable
- Convenient: increased machine availability thanks to quick and easy diagnostics

Key Commercial Data

Packing unit	1 pc
GTIN	 4 017918 967000
GTIN	4017918967000
Weight per Piece (excluding packing)	793.000 g
Custom tariff number	85444290
Country of origin	Poland
Note	Made to Order (non-returnable)

Technical data

General

Rated voltage	24 V DC
Max. operating voltage U_{max}	30 V DC
Current carrying capacity per I/O signal	2 A
Current carrying capacity per slot	2 A
Total rated current	6 A
Number of positions	3
Number of slots	4
Flammability rating according to UL 94	V0
Sensor/actuator connection system	M8 socket

Sensor/actuator box - SACB- 4/3-L-10,0PUR-M8 - 1516027

Technical data

General

Note	NOTE: Observe the permissible bending radii when laying conductors, since the degree of protection may be put in jeopardy if the bending forces are too high. Alleviate mechanical loads upstream of the connector, e.g. by using cable ties.
	Unused slots are to be sealed off prior to commissioning. Suitable sealing elements are to be found under "Accessories".

Ambient conditions

Degree of protection	IP65
	IP67
Ambient temperature (operation)	-30 °C ... 80 °C

Local diagnostics function

Local diagnostics	Supply voltage Green LED
	Status display I/O Yellow LED

Master cable connection data

Connection method	Fixed connection
Length of cable	10 m
Tightening torque slot sensor/actuator cable	0.2 Nm

Insulation material

Housing material	PBT
Material of the moulding mass	PUR
Contact material	CuSn
Contact surface material	Ni/Au
Contact carrier material	PA
Material of threaded sleeve	Cu alloy
Material of threaded sleeve surface	Nickel-plated
O-ring material	NBR

Pin assignment

Slot/position = Wire color or connection	1 / 4 (A) = WH
	2 / 4 (A) = GN
	3 / 4 (A) = YE
	4 / 4 (A) = GY
	1-4 / 1 (+ 24 V) = BN
	1-4 / 3 (0 V) = BU

Standards and Regulations

Standard designation	M8 connector
Standards/regulations	IEC 61076-2-104
Connection in acc. with standard	CUL
Flammability rating according to UL 94	V0

Cable

Sensor/actuator box - SACB- 4/3-L-10,0PUR-M8 - 1516027

Technical data

Cable

Cable type	PUR/PVC black
Cable type (abbreviation)	PUR
Cable abbreviation	LiYY11Y-HF
UL AWM style	20549
Conductor cross section	4x 0.34 mm ² (Signal line)
	2x 0.75 mm ² (power line)
AWG signal line	22
AWG power supply	18
Conductor structure signal line	19x 0.15 mm
Conductor structure, voltage supply	42x 0.15 mm
Core diameter including insulation	1.3 mm ±0.1 mm (Signal line)
	1.8 mm ±0.1 mm (power line)
Wire colors	brown, blue, white, green, yellow, gray
Overall twist	Wires twisted in layers
External sheath, color	black RAL 9005
Inner sheath thickness	≥ 0.15 mm
Outer sheath thickness	≥ 0.38 mm
External cable diameter D	6.8 mm ±0.2 mm
Minimum bending radius, fixed installation	7.5 x D
Minimum bending radius, flexible installation	10 x D
Number of bending cycles	1500000
Bending radius	68 mm
Traversing path	2 m
Traversing rate	2 m/s
Cable weight	71.7 kg/km
Outer sheath, material	PUR
Material, inner sheath	PVC
Material conductor insulation	PVC
Conductor material	Bare Cu litz wires
Nominal voltage, cable	300 V
Test voltage, cable	2000 V
Special properties	Silicone-free
Flame resistance	DIN EN 50265
Resistance to oil	according to VDE 0472 Part 803
Other resistance	Highly resistant to acids, alkaline solutions and solvents
Ambient temperature (operation)	-40 °C ... 90 °C (cable, fixed installation)
	-5 °C ... 80 °C (cable, flexible installation)

Environmental Product Compliance

China RoHS	Environmentally friendly use period: unlimited = EFUP-e
------------	---

Sensor/actuator box - SACB- 4/3-L-10,0PUR-M8 - 1516027

Technical data

Environmental Product Compliance

	No hazardous substances above threshold values
--	--

Drawings

Dimensional drawing

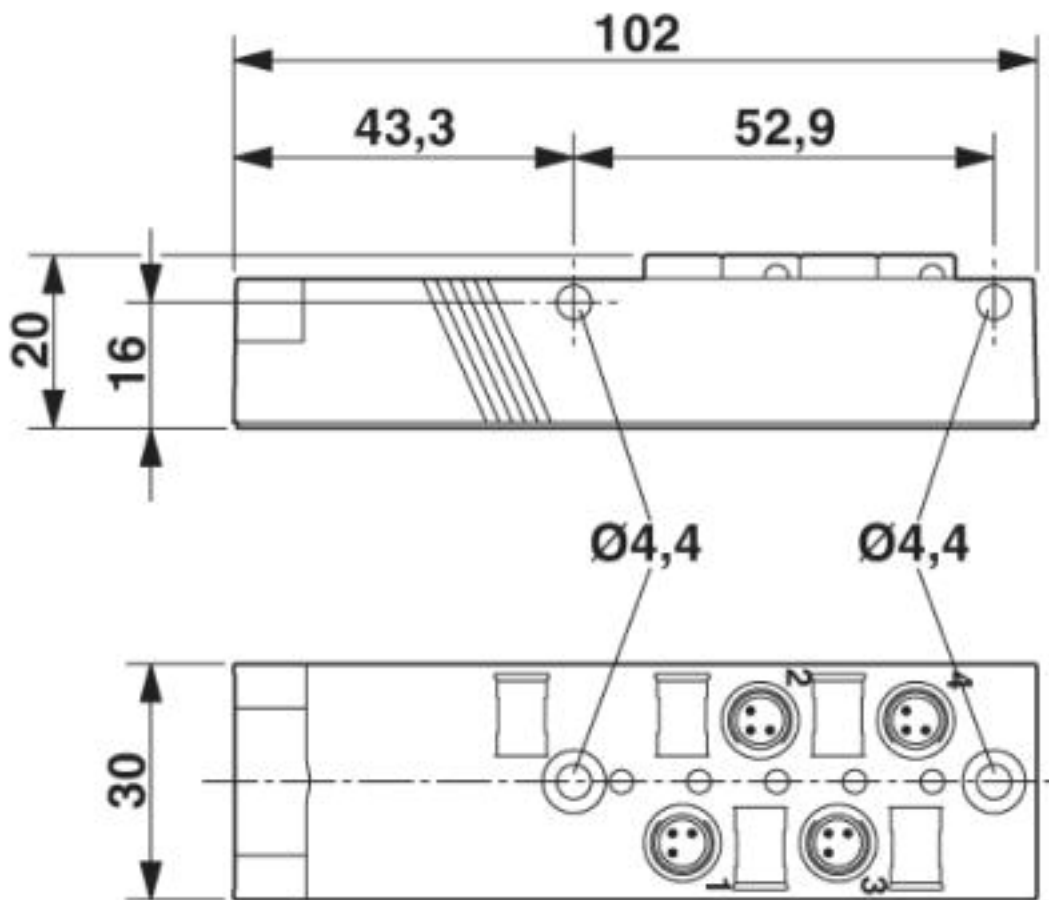

Sensor/actuator box - SACB- 4/3-L-10,0PUR-M8 - 1516027

Circuit diagram

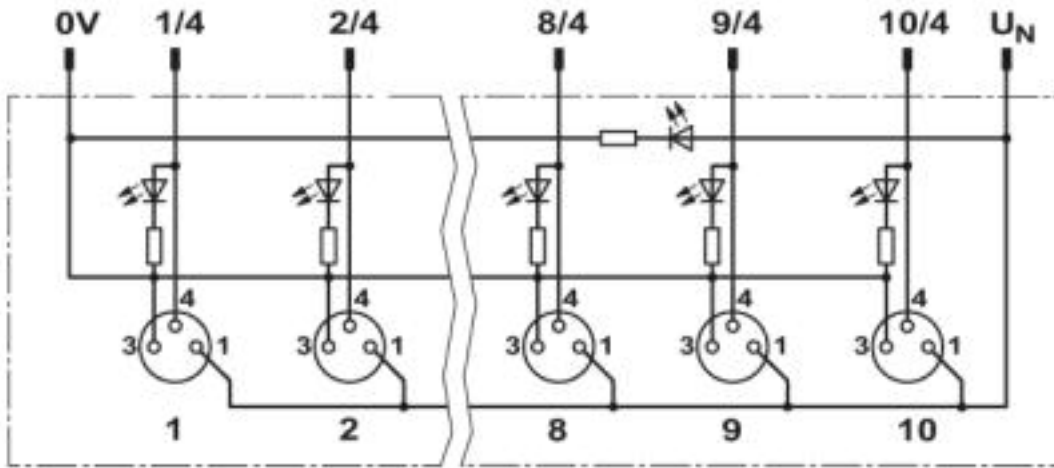

Sensor/actuator box - SACB- 4/3-L-10,0PUR-M8 - 1516027

Schematic diagram

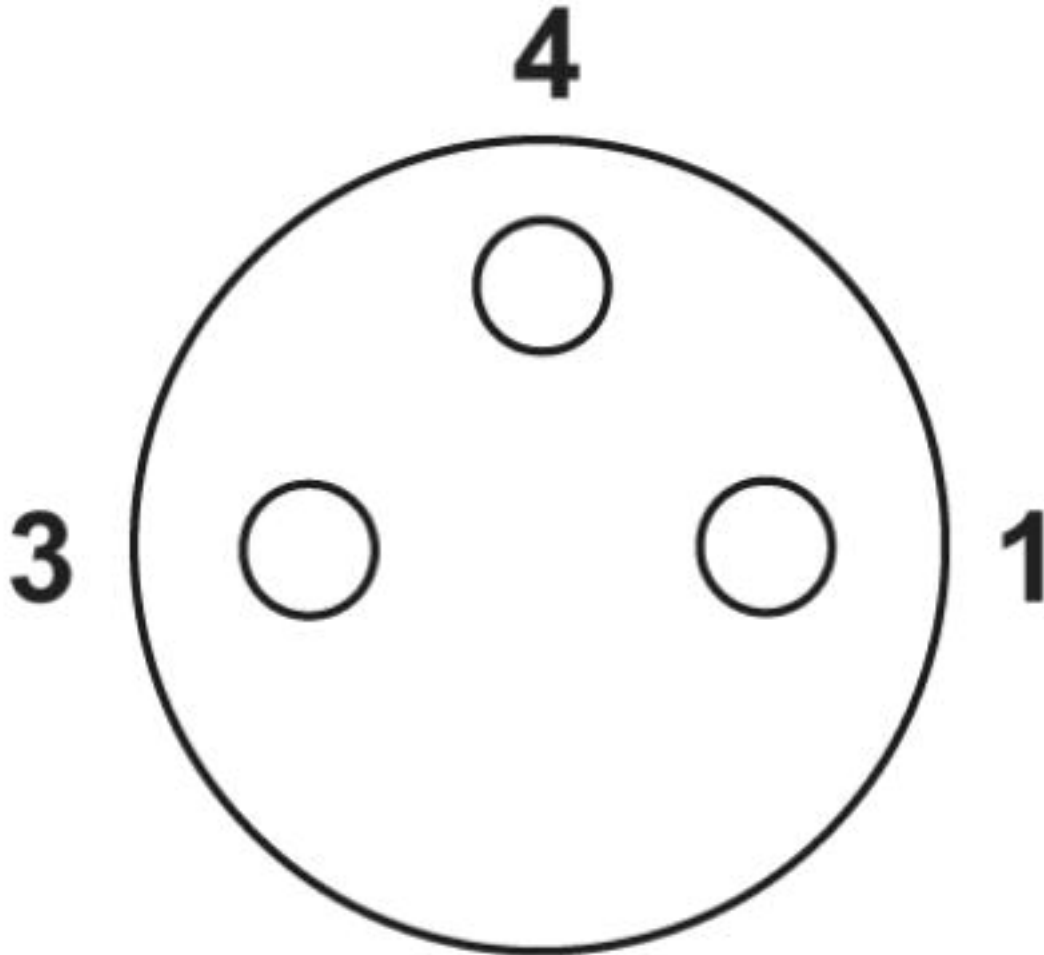

M8 slot, socket, 3-pos.

Sensor/actuator box - SACB- 4/3-L-10,0PUR-M8 - 1516027

Cable cross section

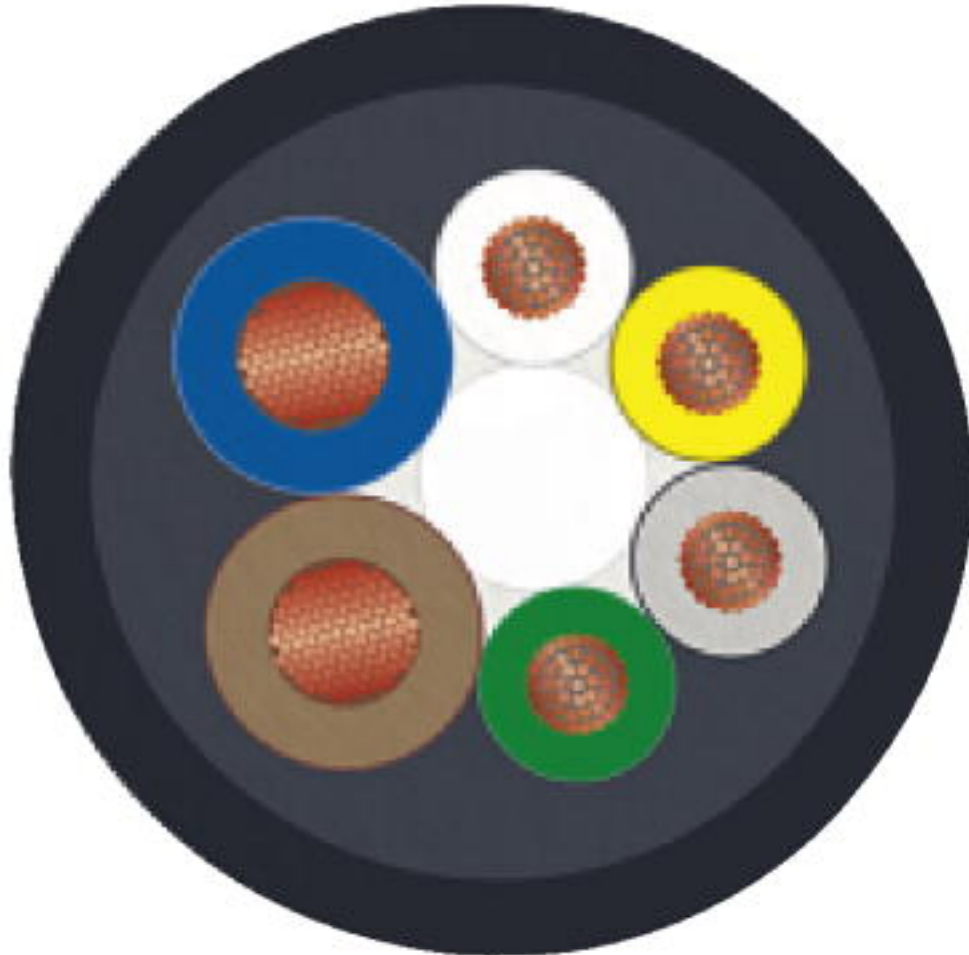

PUR/PVC black [PUR]

Classifications

eCl@ss

eCl@ss 4.0	27140800
eCl@ss 4.1	27140800
eCl@ss 5.0	27143400
eCl@ss 5.1	27250300
eCl@ss 6.0	27279200
eCl@ss 7.0	27279219
eCl@ss 8.0	27279219
eCl@ss 9.0	27440108

Sensor/actuator box - SACB- 4/3-L-10,0PUR-M8 - 1516027

Classifications

ETIM

ETIM 2.0	EC000200
ETIM 3.0	EC001856
ETIM 4.0	EC002585
ETIM 5.0	EC002585
ETIM 6.0	EC002585
ETIM 7.0	EC002585

UNSPSC

UNSPSC 6.01	31261501
UNSPSC 7.0901	31261501
UNSPSC 11	31261501
UNSPSC 12.01	31261501
UNSPSC 13.2	31251501
UNSPSC 19.0	31251501
UNSPSC 20.0	31251501
UNSPSC 21.0	31251501

Approvals

Approvals

Approvals

UL Recognized / cUL Recognized / EAC / cULus Recognized

Ex Approvals

Approval details

UL Recognized		http://database.ul.com/cgi-bin/XYV/template/LISEXT/1FRAME/index.htm	FILE E 118976
Nominal voltage UN		24 V	

cUL Recognized		http://database.ul.com/cgi-bin/XYV/template/LISEXT/1FRAME/index.htm	FILE E 118976
Nominal voltage UN		24 V	

Sensor/actuator box - SACB- 4/3-L-10,0PUR-M8 - 1516027

Approvals

EAC		RU C- DE.BL08.B.00286
-----	--	--------------------------

cULus Recognized	
------------------	--

Accessories

Accessories

Labeled terminal marker

Marker for terminal blocks - UC-TMF 10 CUS - 0824662



Marker for terminal blocks, can be ordered: by sheet, white, labeled according to customer specifications, mounting type: snap into flat marker groove, for terminal block width: 10.2 mm, lettering field size: 9.6 x 5.1 mm, Number of individual labels: 48

Marker for terminal blocks - UCT-TMF 10 CUS - 0829679



Marker for terminal blocks, can be ordered: by sheet, white, labeled according to customer specifications, mounting type: snap into flat marker groove, for terminal block width: 10.2 mm, lettering field size: 9.4 x 4.7 mm, Number of individual labels: 36

Marker for terminal blocks - UC-TMF 10 YE CUS - 0824668



Marker for terminal blocks, can be ordered: by sheet, yellow, labeled according to customer specifications, mounting type: snap into flat marker groove, for terminal block width: 10.2 mm, lettering field size: 9.6 x 5.1 mm, Number of individual labels: 48

Marker for terminal blocks - UCT-TMF 10 YE CUS - 0829682



Marker for terminal blocks, can be ordered: by sheet, yellow, labeled according to customer specifications, mounting type: snap into flat marker groove, for terminal block width: 10.2 mm, lettering field size: 9.4 x 4.7 mm, Number of individual labels: 36

Sensor/actuator box - SACB- 4/3-L-10,0PUR-M8 - 1516027

Accessories

Plug for cable screw gland

Screw plug - PROT-M8 - 1682540



An M8 screw plug for the unoccupied M8 sockets of the sensor/actuator cable, boxes and flush-type connectors

Screwdriver tools

Tool - SAC BIT M8-D10 - 1208461



Nut for assembling M8 connectors with longitudinal knurl and a knurl diameter of 10 mm, for 4 mm hexagonal drive

Tool - SACC BIT M8-D12 - 1208474



Nut for assembling M8 connectors with longitudinal knurl and a knurl diameter of 12 mm, for 4 mm hexagonal drive

Terminal marking

Marker for terminal blocks - UC-TMF 10 - 0818124



Marker for terminal blocks, Sheet, white, unlabeled, can be labeled with: BLUEMARK ID COLOR, BLUEMARK ID, BLUEMARK CLED, PLOTMARK, CMS-P1-PLOTTER, mounting type: snap into flat marker groove, for terminal block width: 10.2 mm, lettering field size: 9.6 x 5.1 mm, Number of individual labels: 48

Marker for terminal blocks - UCT-TMF 10 - 0829204



Marker for terminal blocks, Sheet, white, unlabeled, can be labeled with: TOPMARK NEO, TOPMARK LASER, BLUEMARK ID COLOR, BLUEMARK ID, BLUEMARK CLED, THERMOMARK PRIME, THERMOMARK CARD 2.0, THERMOMARK CARD, mounting type: snap into flat marker groove, for terminal block width: 10.2 mm, lettering field size: 9.4 x 4.7 mm, Number of individual labels: 36

Sensor/actuator box - SACB- 4/3-L-10,0PUR-M8 - 1516027

Accessories

Marker for terminal blocks - UC-TMF 10 YE - 0818687



Marker for terminal blocks, Sheet, yellow, unlabeled, can be labeled with: BLUEMARK ID COLOR, BLUEMARK ID, BLUEMARK CLED, PLOTMARK, CMS-P1-PLOTTER, mounting type: snap into flat marker groove, for terminal block width: 10.2 mm, lettering field size: 9.6 x 5.1 mm, Number of individual labels: 48

Marker for terminal blocks - UCT-TMF 10 YE - 0829207



Marker for terminal blocks, Sheet, yellow, unlabeled, can be labeled with: TOPMARK NEO, TOPMARK LASER, BLUEMARK ID COLOR, BLUEMARK ID, BLUEMARK CLED, THERMOMARK PRIME, THERMOMARK CARD 2.0, THERMOMARK CARD, mounting type: snap into flat marker groove, for terminal block width: 10.2 mm, lettering field size: 9.4 x 4.7 mm, Number of individual labels: 36

Torque tool

Torque screwdriver - TSD 02 SAC - 1208487



Torque screwdriver, with preset torque of 0.2 Nm and 4 mm hexagonal drive for M8 connectors