

LQH31MN5R6J03#

indicates a package specification code.



< List of part numbers with package codes >
 LQH31MN5R6J03L , LQH31MN5R6J03K

Shape

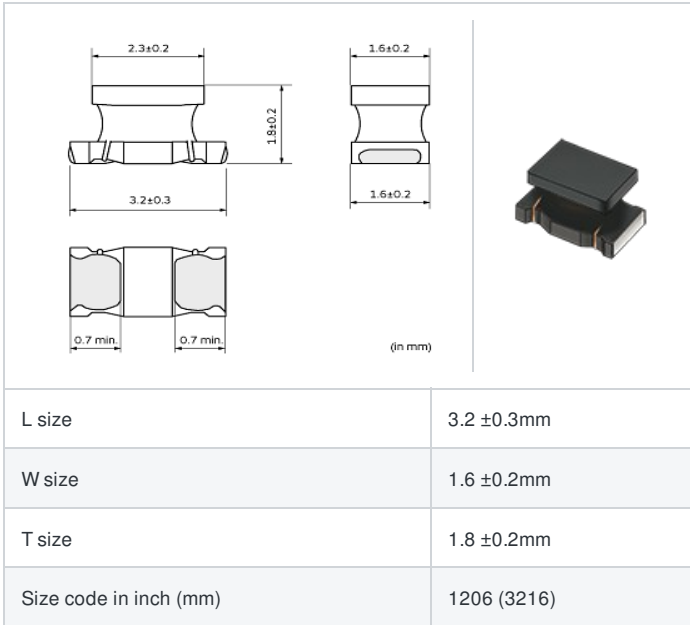

Notes

When rated current is applied to the products, self-temperature rise shall be limited to 20 °C max and inductance will be within ±10% of initial inductance value.

References

| Packaging code | Specifications | Minimum quantity |
|----------------|------------------------|------------------|
| L | φ180mm Embossed taping | 2000 |
| K | φ330mm Embossed taping | 7500 |

| Mass (Typ.) | |
|-------------|--------|
| 1 piece | 0.029g |

Specifications

| | |
|---|---------------|
| Inductance | 5.6μH ±5% |
| Inductance test frequency | 1MHz |
| Rated current (Itemp) (Based on Temperature rise) | 115mA |
| Max. of DC resistance | 2.34Ω |
| Avg. of DC resistance | 1.8Ω ±30% |
| Q (min.) | 35 |
| Q test frequency | 8MHz |
| Self resonance frequency (min.) | 28MHz |
| Operating temperature range (Self-temperature rise is not included) | -40°C to 85°C |
| Class of magnetic shield | No Shield |
| Series | LQH31MN_03 |

Attention

- 1.This datasheet is downloaded from the website of Murata Manufacturing Co., Ltd. Therefore, it's specifications are subject to change or our products in it may be discontinued without advance notice. Please check with our sales representatives or product engineers before ordering.
- 2.This datasheet has only typical specifications because there is no space for detailed specifications. Therefore, please review our product specifications or consult the approval sheet for product specifications before ordering.

Chart of characteristic data (The charts below may show another part number which shares its characteristics.)

▪ Inductance-Current characteristics (Typ.)

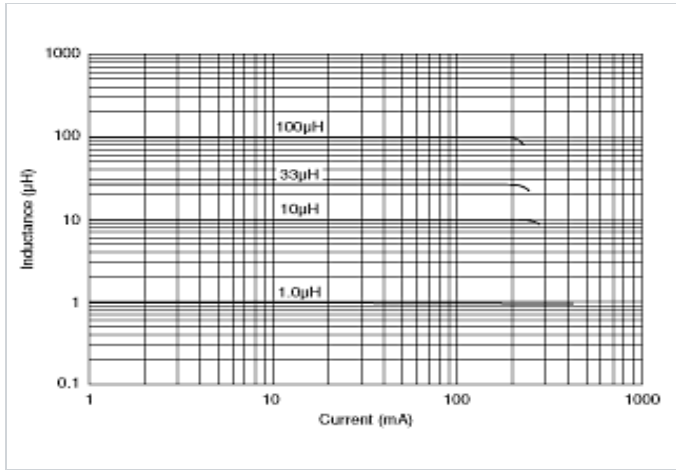

▪ Q-Frequency characteristics (Typ.)

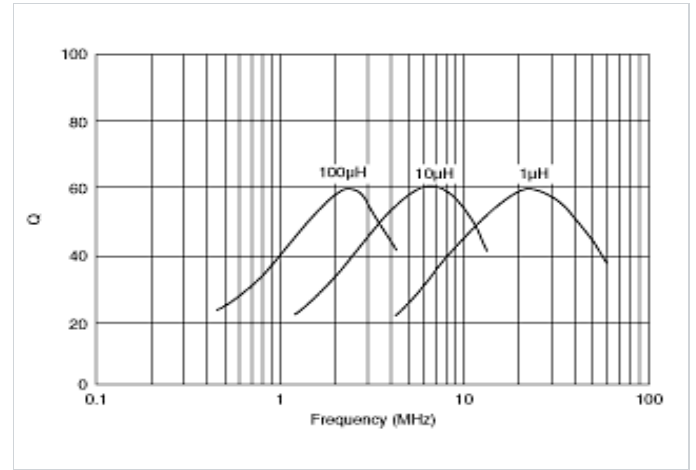

⚠ Attention

- 1.This datasheet is downloaded from the website of Murata Manufacturing Co., Ltd. Therefore, it's specifications are subject to change or our products in it may be discontinued without advance notice. Please check with our sales representatives or product engineers before ordering.
- 2.This datasheet has only typical specifications because there is no space for detailed specifications. Therefore, please review our product specifications or consult the approval sheet for product specifications before ordering.