

LQH32PH6R8NN0#

"#" indicates a package specification code.



< List of part numbers with package codes >
 LQH32PH6R8NN0L , LQH32PH6R8NN0K

Shape

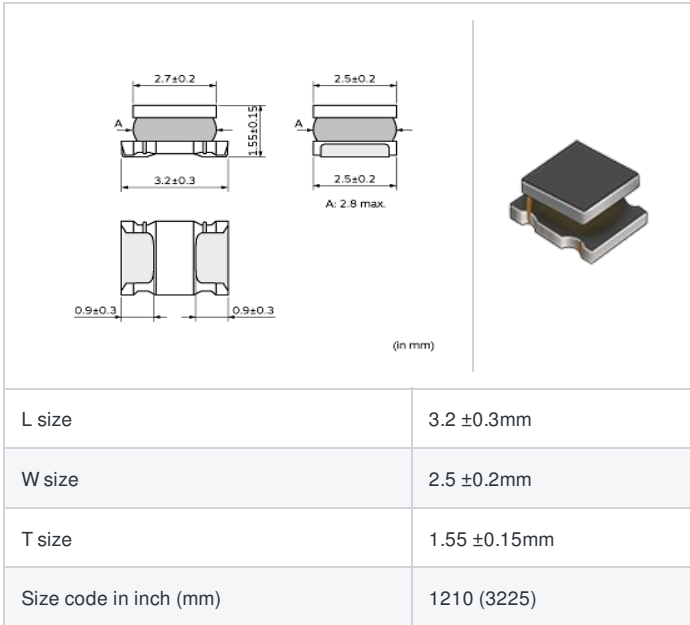

Notes

When rated current is applied to the products, inductance will be within ±30% of nominal inductance value.
 When rated current is applied to the products, the temperature rise caused by self-generated heat shall be limited to 40°C max.
 Keep the temperature (ambient temperature plus self-generation of heat) under 125°C.

References

Packaging code	Specifications	Minimum quantity
L	φ180mm Embossed taping	2000
K	φ330mm Embossed taping	7500

Mass (Typ.)	
1 piece	0.044g

Specifications

Inductance	6.8μH ±30%
Inductance test frequency	1MHz
Rated current (I _{sat}) (Based on Inductance change)	850mA
Rated current (I _{temp}) (Based on Temperature rise)	850mA(Ambient temp.85°C) 510mA(Ambient temp.105°C)
Max. of DC resistance	0.288Ω
Avg. of DC resistance	0.24Ω ±20%
Self resonance frequency (min.)	40MHz
Operating temperature range (Self-temperature rise is included)	-40 to 125°C
Operating temperature range (Self-temperature rise is not included)	-40 to 105°C
Class of magnetic shield	Magnetic Resin
Series	LQH32PH_N0

Attention

- This datasheet is downloaded from the website of Murata Manufacturing Co., Ltd. Therefore, it's specifications are subject to change or our products in it may be discontinued without advance notice. Please check with our sales representatives or product engineers before ordering.
- This datasheet has only typical specifications because there is no space for detailed specifications. Therefore, please review our product specifications or consult the approval sheet for product specifications before ordering.

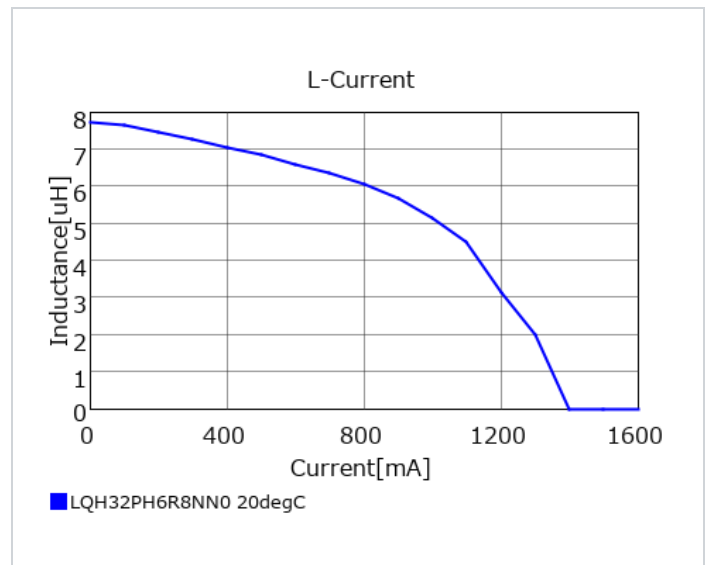
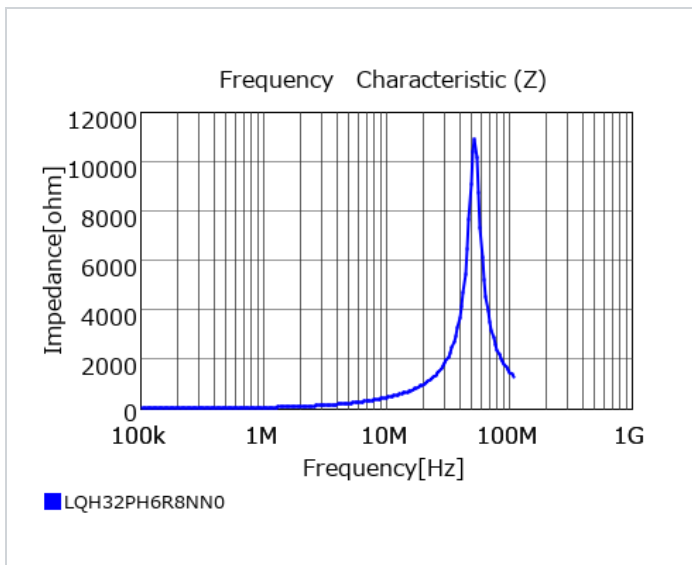
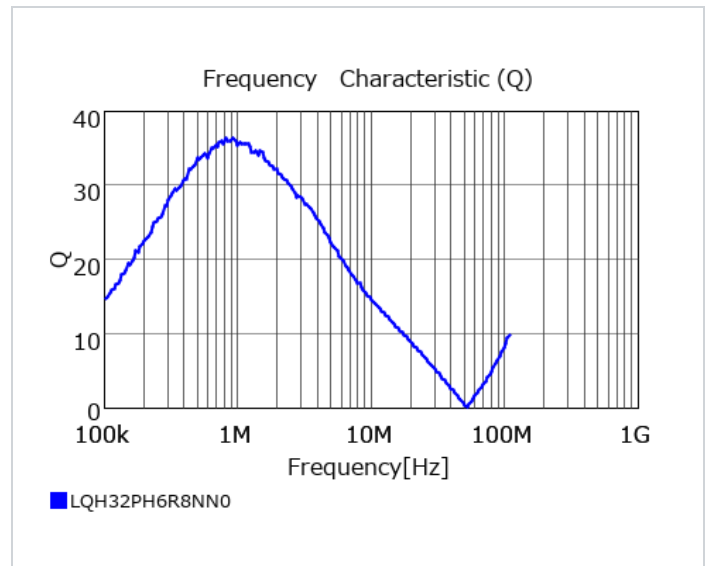
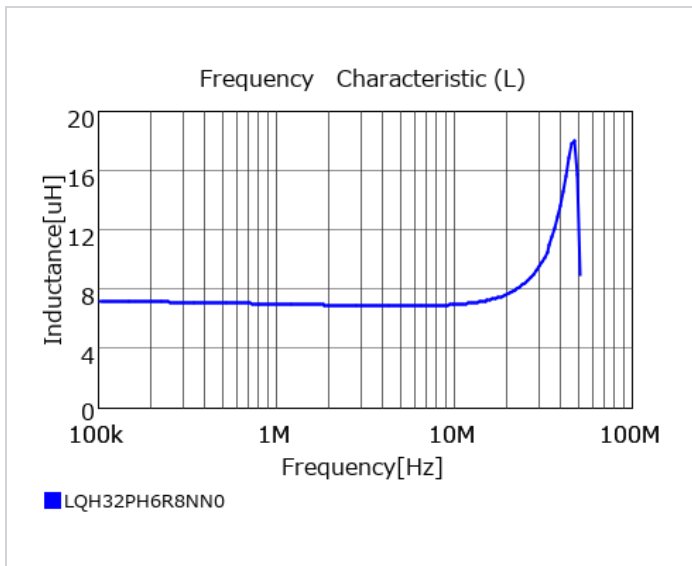

⚠ Attention

- 1.This datasheet is downloaded from the website of Murata Manufacturing Co., Ltd. Therefore, it's specifications are subject to change or our products in it may be discontinued without advance notice. Please check with our sales representatives or product engineers before ordering.
 - 2.This datasheet has only typical specifications because there is no space for detailed specifications.
- Therefore, please review our product specifications or consult the approval sheet for product specifications before ordering.