

# LQH3NPZ220MJR#

"#" indicates a package specification code.



< List of part numbers with package codes >  
LQH3NPZ220MJRL

## Shape

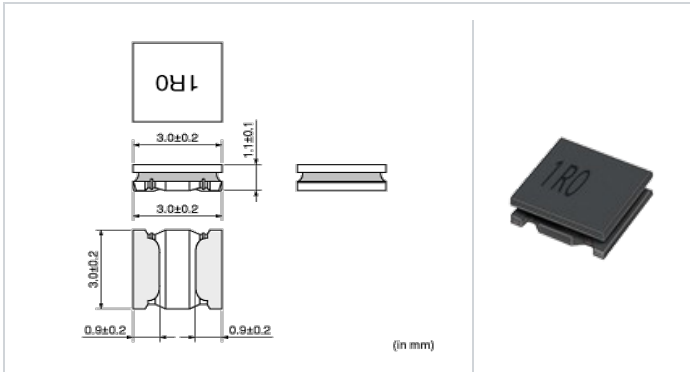

L size	3.0 ±0.2mm
W size	3.0 ±0.2mm
T size	1.1 ±0.1mm
Size code in inch (mm)	1212 (3030)

## Notes

When rated current is applied to the products, inductance will be within ±30% of initial inductance value range.  
 Keep the temperature (ambient temperature plus self-generation of heat) under 125°C.  
 When rated current is applied to the products, the self-temperature rise shall be limited to 40°C max. (ambient temperature 85°C).  
 When rated current is applied to the products, the self-temperature rise shall be limited to 20°C max. (ambient temperature 85°C to 105°C).

## References

Packaging code	Specifications	Minimum quantity
L	φ180mm Embossed taping	2000

Mass (Typ.)	
1 piece	0.045g

## Specifications

Inductance	22μH ±20%
Inductance test frequency	1MHz
Rated current (I <sub>sat</sub> ) (Based on Inductance change)	520mA
Rated current (I <sub>temp</sub> ) (Based on Temperature rise)	800mA(Ambient temp.85°C) 350mA(Ambient temp.105°C)
Max. of DC resistance	0.6Ω
Avg. of DC resistance	0.50Ω±20%
Self resonance frequency (min.)	20MHz
Operating temperature range (Self-temperature rise is included)	-40°C to 125°C
Operating temperature range (Self-temperature rise is not included)	-40°C to 105°C
Class of magnetic shield	Magnetic Resin
Series	LQH3NPZ_JR

### Attention

- This datasheet is downloaded from the website of Murata Manufacturing Co., Ltd. Therefore, it's specifications are subject to change or our products in it may be discontinued without advance notice. Please check with our sales representatives or product engineers before ordering.
- This datasheet has only typical specifications because there is no space for detailed specifications. Therefore, please review our product specifications or consult the approval sheet for product specifications before ordering.

**Chart of characteristic data (The charts below may show another part number which shares its characteristics.)**

▪ Inductance-Frequency characteristics (Typ.)

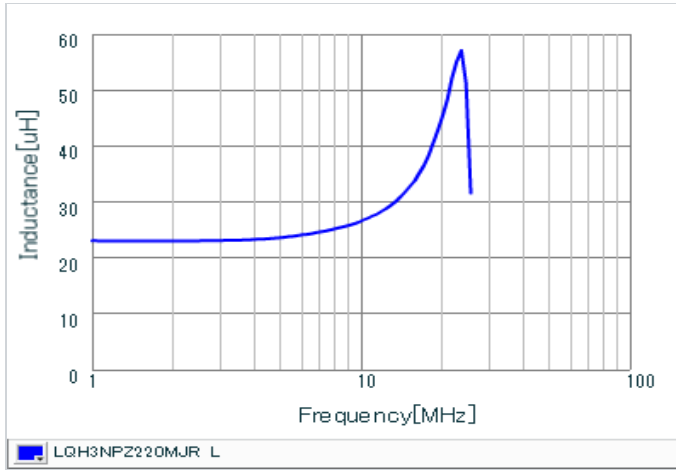

▪ Inductance-Current characteristics (Typ.)

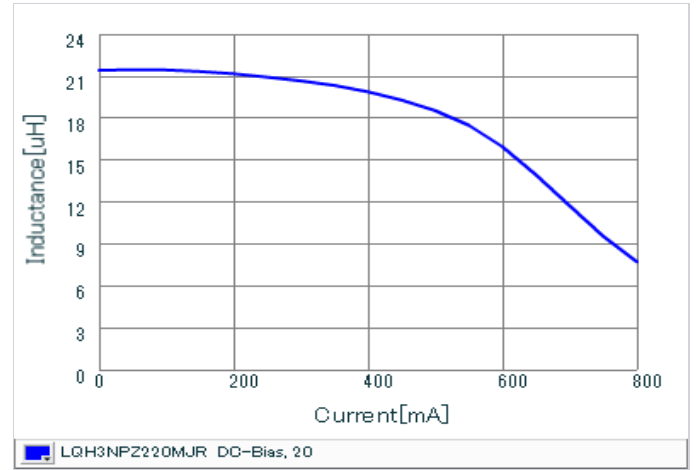

▪ Temperature rise characteristics (Typ.)

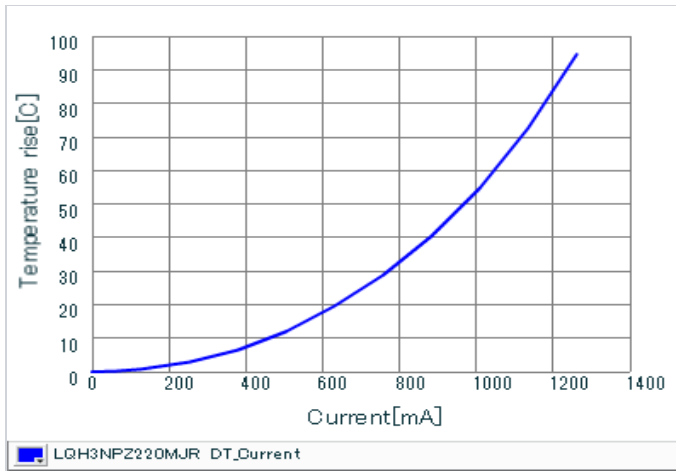

**⚠ Attention**

- 1.This datasheet is downloaded from the website of Murata Manufacturing Co., Ltd. Therefore, it's specifications are subject to change or our products in it may be discontinued without advance notice. Please check with our sales representatives or product engineers before ordering.
- 2.This datasheet has only typical specifications because there is no space for detailed specifications. Therefore, please review our product specifications or consult the approval sheet for product specifications before ordering.