

LQH43NN821K03#

"#" indicates a package specification code.



< List of part numbers with package codes >
 LQH43NN821K03L , LQH43NN821K03K

Shape

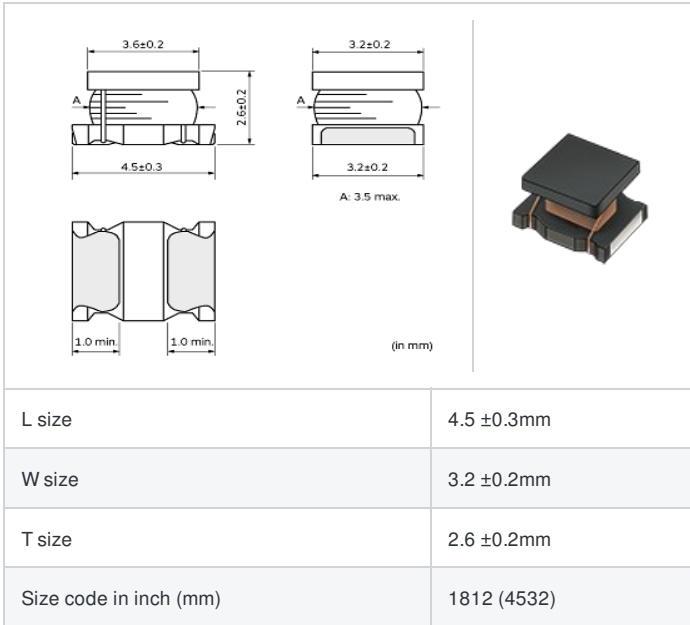

Notes

When rated current is applied to the products, self-temperature rise shall be limited to 20°C max and inductance will be within ±10% of initial inductance value.

References

Packaging code	Specifications	Minimum quantity
L	φ180mm Embossed taping	500
K	φ330mm Embossed taping	2500

Mass (Typ.)	
1 piece	0.13g

Specifications

Inductance	820μH ±10%
Inductance test frequency	1kHz
Rated current (Itemp) (Based on Temperature rise)	60mA
Max. of DC resistance	20.5Ω
Q (min.)	40
Q test frequency	796kHz
Self resonance frequency (min.)	2.2MHz
Operating temperature range	-40°C to 105°C
Class of magnetic shield	No Shield
Series	LQH43NN_03

Attention

- 1.This datasheet is downloaded from the website of Murata Manufacturing Co., Ltd. Therefore, it's specifications are subject to change or our products in it may be discontinued without advance notice. Please check with our sales representatives or product engineers before ordering.
- 2.This datasheet has only typical specifications because there is no space for detailed specifications. Therefore, please review our product specifications or consult the approval sheet for product specifications before ordering.