

U.S. Patent No. 5043695

**Electrical Characteristics**

Contact Rating  
 Maximum Current .....100 mA max.  
 Maximum Voltage .....16 V  
 Contact Timing.....Non-shorting  
 Contact Resistance .....2 ohms max.  
 Insulation Resistance  
 .....100 megohms min.  
 Dielectric Strength .....250 VAC

**General Characteristics**

Switch Type .....SPDT  
 Operating Temperature Range  
 .....-55 °C to +125 °C  
 Storage Temperature Range  
 .....-55 °C to +125 °C  
 Seal Test .....85 °C Fluorinert†

**Mechanical Characteristics**

Positions .....2  
 Adjustment Torque......5 N-cm max.  
 Stop Strength.....1.8 N-cm min.

**Environmental Characteristics**

Shock .....20 G  
 0.1 ms max. discontinuity  
 Vibration .....100 G  
 0.1 ms max. discontinuity  
 Thermal Shock .....(5 cycles)  
 -55 °C to +125 °C  
 Humidity  
 Insulation Resistance  
 .....10 megohms min.  
 Rotational Life  
 -051 .....50 Cycles  
 -023 .....2000 Cycles  
 Max. Soldering Heat .....245 °C,  
 5 seconds  
 Standard Packaging  
 J .....1,000 pcs./reel  
 S .....200 pcs./reel

**How to Order**

**7813 J - 1 - 051 E**

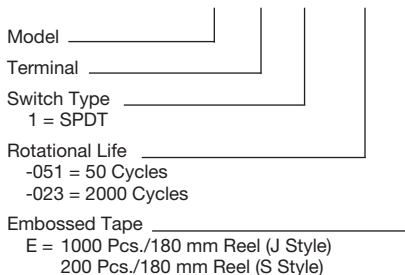

**Features**

- Single pole/double throw
- Compatible with most surface mount manufacturing processes
- 50 or 2000 cycle rotational life
- Tape and reel packaged
- Withstands 245 ° soldering heat

■ RoHS compliant\*

**7813 SMD 3 mm Square Sealed Rotary Switch**

**Product Dimensions**

**7813J**

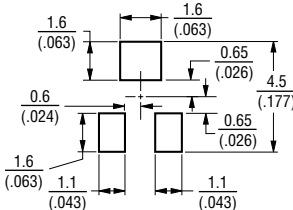
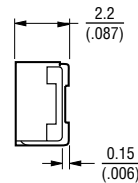
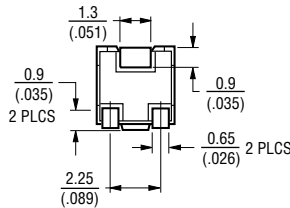
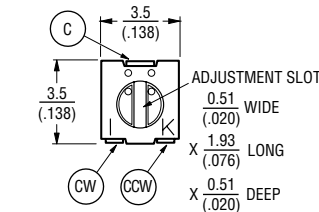

**7813S**

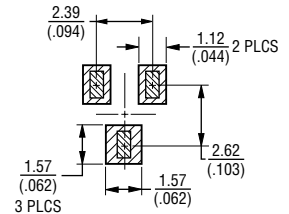
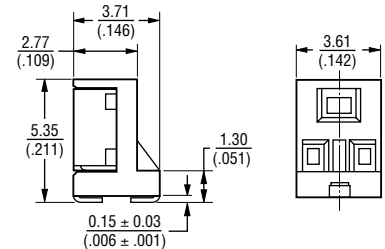
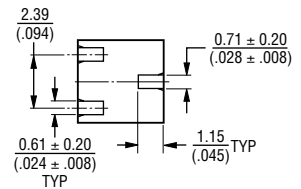
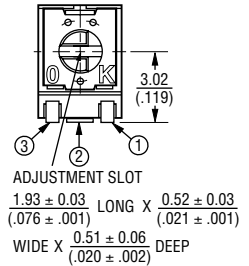

RECOMMENDED LAND PATTERN

DIMENSIONS ARE:  $\frac{\text{MM}}{\text{(INCHES)}}$

TOLERANCES: ±.2 EXCEPT WHERE NOTED.

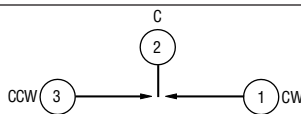

\*RoHS Directive 2002/95/EC Jan 27 2003 including Annex.  
 †"Fluorinert" is a registered trademark of 3M Co.  
 Specifications are subject to change without notice.  
 Customers should verify actual device performance in their specific applications.

# 7813 SMD 3 mm Square Sealed Rotary Switch

**BOURNS®**

## Packaging Specifications

7813J

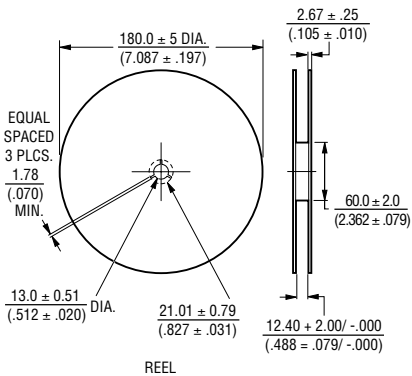
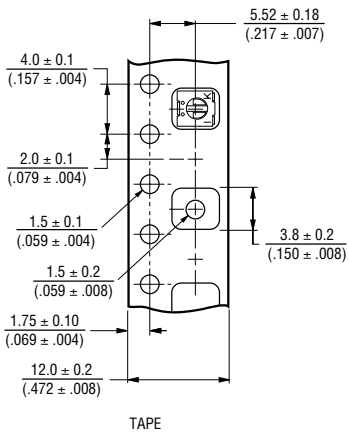
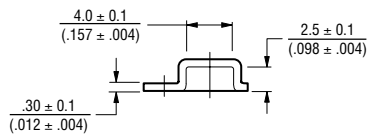

Meets EIA 481

7813S

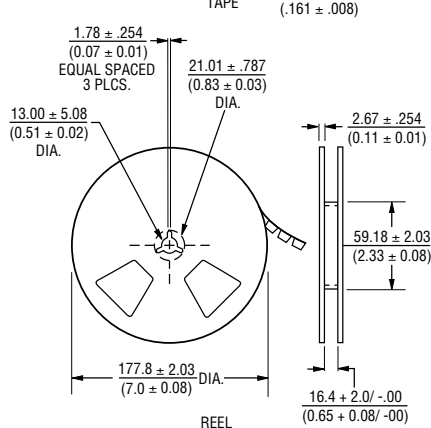
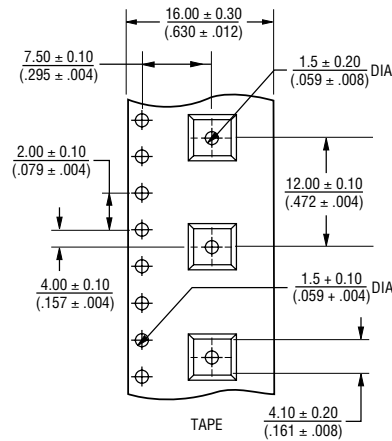
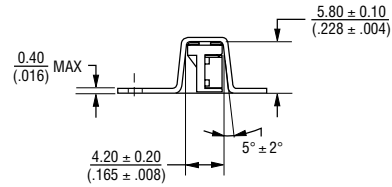

Meets EIA 481

## Reflow Soldering Profile

