

LQW18AN27NJ8Z#

"#" indicates a package specification code.



< List of part numbers with package codes >
 LQW18AN27NJ8ZD , LQW18AN27NJ8ZJ , LQW18AN27NJ8ZB

Shape

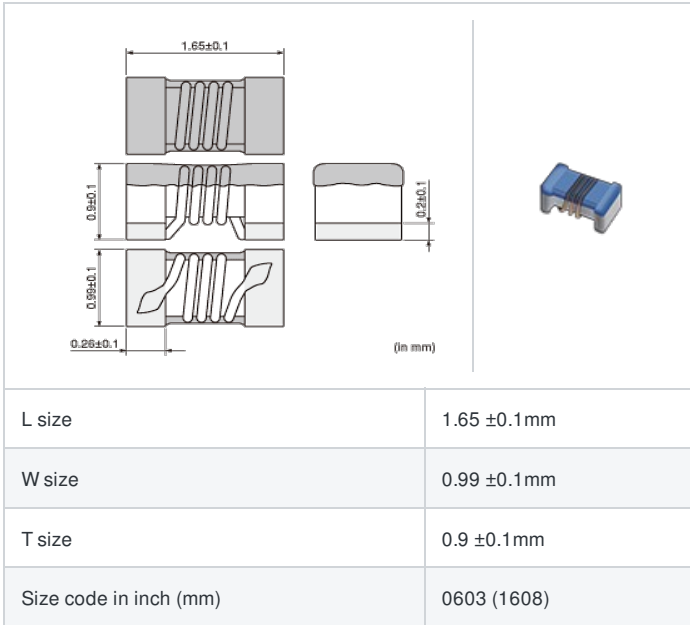

Notes

Please consider 'Notice (Rating).'
 When rated current is applied to the products, the temperature rise caused by self-generated heat shall be limited to 40°C max.

References

Packaging code	Specifications	Minimum quantity
D	φ180mm Paper taping	4000
J	φ330mm Paper taping	10000
B	Packing in bulk	500

Mass (Typ.)	
1 piece	0.0034g

Specifications

Inductance	27nH ±5%
Inductance test frequency	100MHz
Rated current (Itemp) (Based on Temperature rise)	1200mA
Max. of DC resistance	0.098Ω
Q (min.)	40
Q test frequency	250MHz
Self resonance frequency (min.)	3600MHz
Operating temperature range (Self-temperature rise is not included)	-55 to 125°C
Series	LQW18AN_8Z

Attention

- 1.This datasheet is downloaded from the website of Murata Manufacturing Co., Ltd. Therefore, it's specifications are subject to change or our products in it may be discontinued without advance notice. Please check with our sales representatives or product engineers before ordering.
- 2.This datasheet has only typical specifications because there is no space for detailed specifications. Therefore, please review our product specifications or consult the approval sheet for product specifications before ordering.

In operating temperatures exceeding +85°C, derating of current is necessary for this series.
Please apply the derating curve shown in the chart according to the operating temperature.

Derating of Rated Current



 **Attention**

1.This datasheet is downloaded from the website of Murata Manufacturing Co., Ltd. Therefore, it's specifications are subject to change or our products in it may be discontinued without advance notice. Please check with our sales representatives or product engineers before ordering.

2.This datasheet has only typical specifications because there is no space for detailed specifications.

Therefore, please review our product specifications or consult the approval sheet for product specifications before ordering.

Chart of characteristic data (The charts below may show another part number which shares its characteristics.)

▪ Inductance-Frequency characteristics (Typ.)

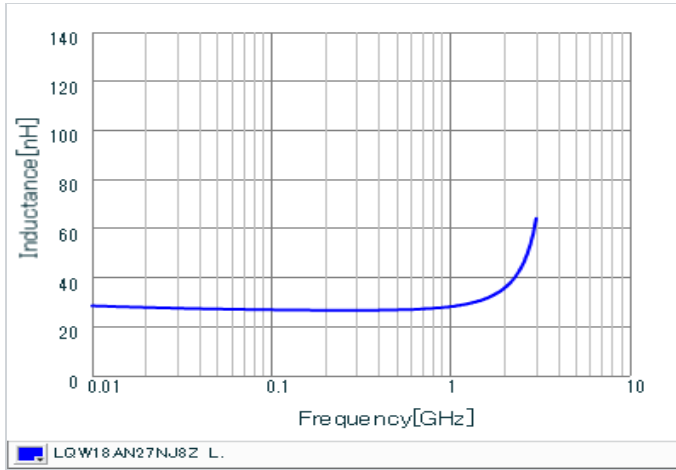

▪ Q-Frequency characteristics (Typ.)

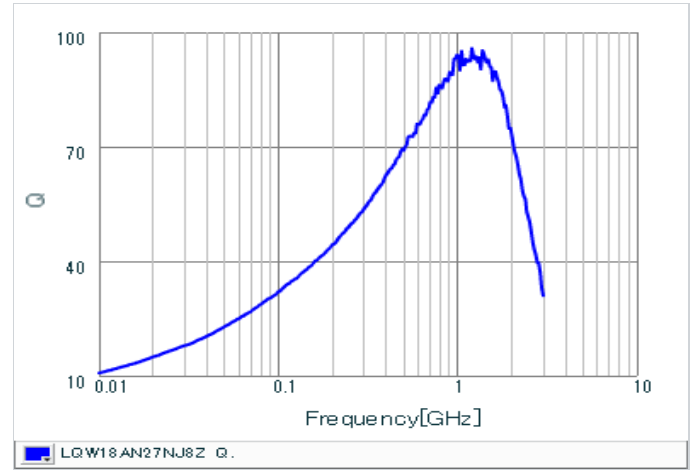

⚠ Attention

- 1.This datasheet is downloaded from the website of Murata Manufacturing Co., Ltd. Therefore, it's specifications are subject to change or our products in it may be discontinued without advance notice. Please check with our sales representatives or product engineers before ordering.
- 2.This datasheet has only typical specifications because there is no space for detailed specifications.
Therefore, please review our product specifications or consult the approval sheet for product specifications before ordering.