

String combiner box (SCB) - SOL-SC-1ST-0-DC-3MPPT-1001 - 2404301

Please be informed that the data shown in this PDF Document is generated from our Online Catalog. Please find the complete data in the user's documentation. Our General Terms of Use for Downloads are valid (<http://phoenixcontact.com/download>)



String combiner box for photovoltaic systems up to 1000 V DC for the connection of 3x 1 string. With surge protection and SUNCLIX DC connector for the input and output side.

Product Description

The Solarline string combiner boxes (SCBs) are used in both small rooftop systems and large ground-mounted systems. Their functions include collecting and protecting strings and, if necessary, separating the panels from the rest of the system by means of a switch disconnecter or fire service switch disconnecter.

Your advantages

- Fast installation and startup
- Large portfolio of string combiner boxes in stock
- Application-oriented consultation
- Standard-compliant switchgear and controlgear assembly, thanks to use of DIN EN 61439



Key Commercial Data

Packing unit	1 pc
GTIN	
GTIN	4055626396255
Weight per Piece (excluding packing)	3,100.000 g
Custom tariff number	85363030
Country of origin	Germany

Technical data

System parameter

System voltage	1000 V DC (U_{max})
Number of string inputs	1 (per MPP tracker)
Current per string (max.)	40 A (I_{max})
Number of outputs	1 (per MPP tracker)
Number of supported MPP trackers	3

String combiner box (SCB) - SOL-SC-1ST-0-DC-3MPPT-1001 - 2404301

Technical data

Safety equipment

Surge protective device	T1 / T2
Protection level U_p	≤ 3.5 kV
Total discharge current I_{total} (8/20) μ s	40 kA
Total discharge current I_{total} (10/350) μ s	5 kA

Cable entry

Type of cable entry	SUNCLIX
Cable cross section string input	2.5 mm ² ... 6 mm ²
Cable cross section output	2.5 mm ² ... 6 mm ²
Cable cross section grounding	16 mm ² (2x)
Sealing area grounding	6 mm ... 12 mm (2x)

General data

Material cover/door	Polycarbonate (transparent)
Housing material	Polycarbonate
Degree of protection	IP65
Protection class	II

Dimensions

Outer dimensions: width, height, depth	254 mm x 180 mm x 111 mm (Housing dimensions)
--	---

Ambient conditions

Ambient temperature (operation)	-20 °C ... 55 °C
---------------------------------	------------------

Drawings

String combiner box (SCB) - SOL-SC-1ST-0-DC-3MPPT-1001 - 2404301

Schematic diagram



Connection of the protective grounding conductor

Schematic diagram



Connection of the protective equipotential bonding conductor

String combiner box (SCB) - SOL-SC-1ST-0-DC-3MPPT-1001 - 2404301

Connection diagram

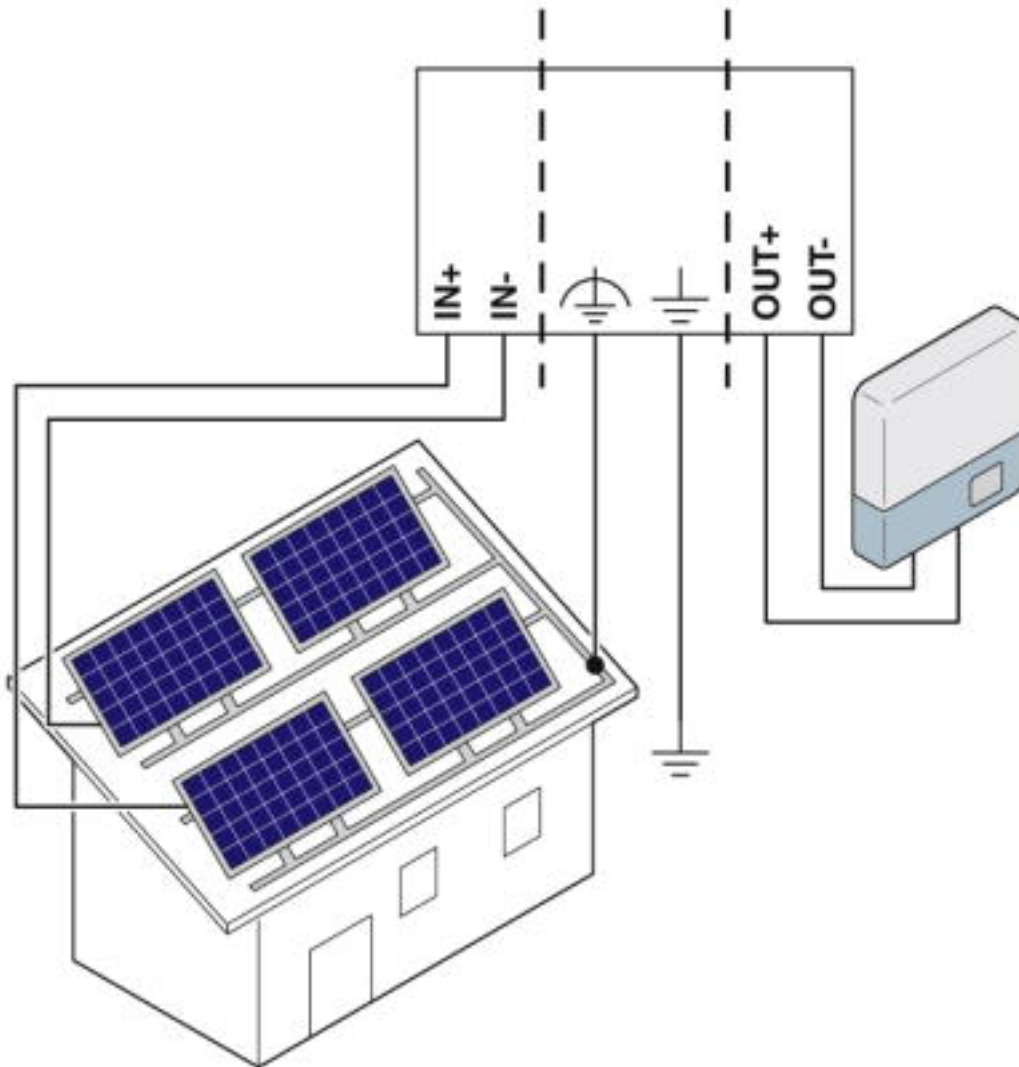

Schematic application drawing

String combiner box (SCB) - SOL-SC-1ST-0-DC-3MPPT-1001 - 2404301

Dimensional drawing

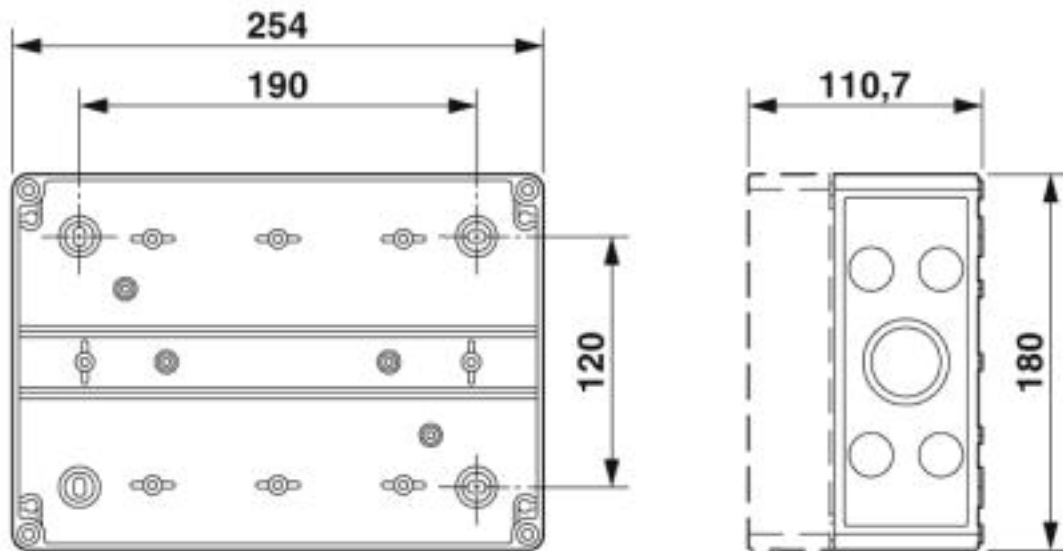

Housing dimensions

String combiner box (SCB) - SOL-SC-1ST-0-DC-3MPPT-1001 - 2404301

Circuit diagram

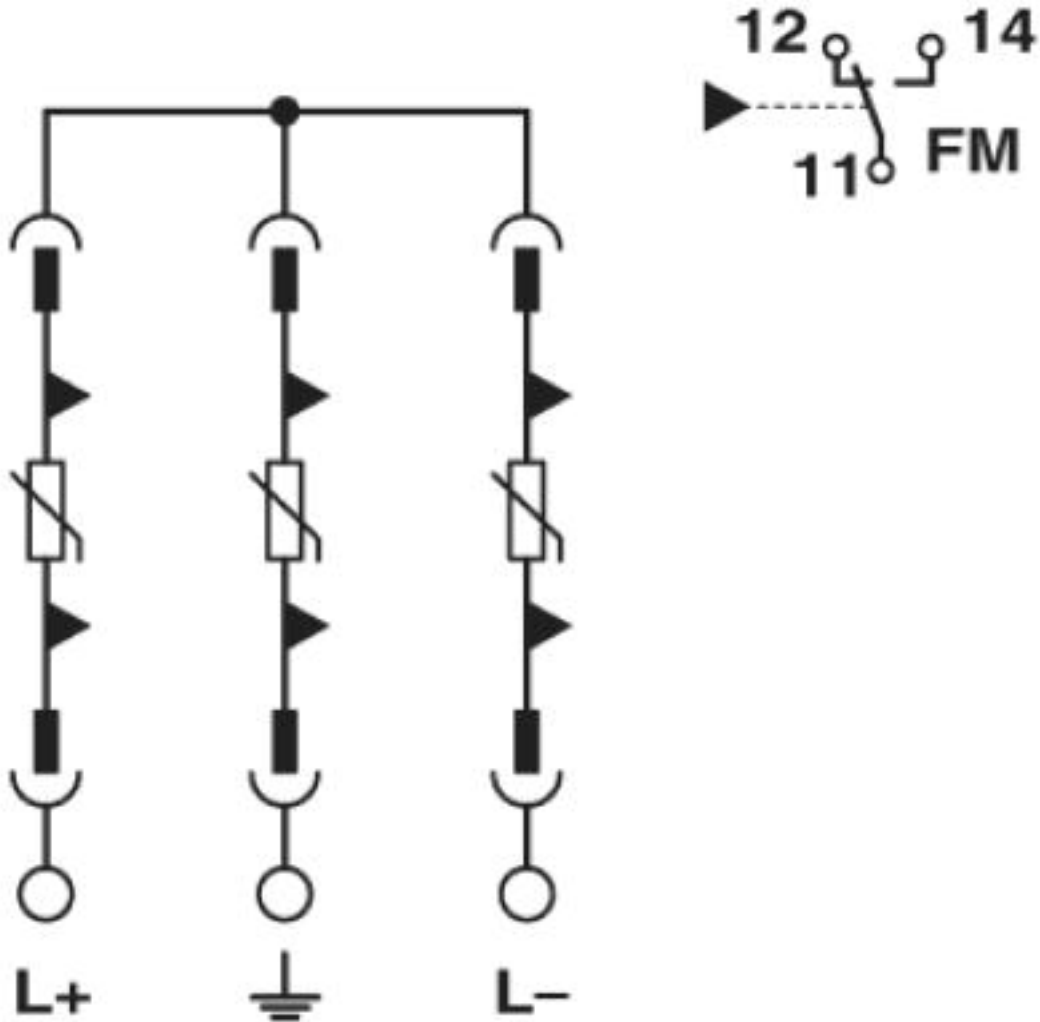

Connection of the remote indication contact on the surge protection

String combiner box (SCB) - SOL-SC-1ST-0-DC-3MPPT-1001 - 2404301

Schematic diagram

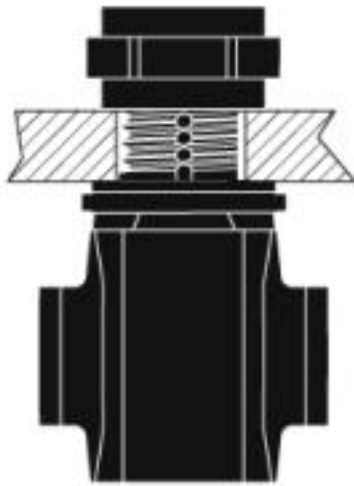

IN+

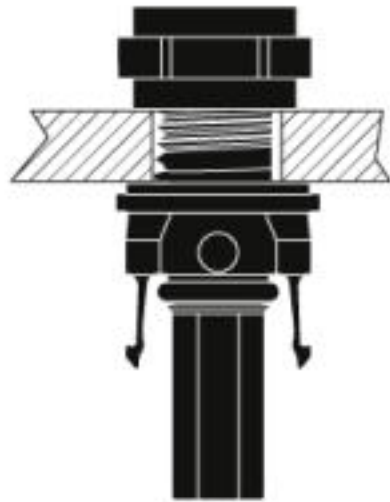

IN-

Connection of the PV strings

Schematic diagram

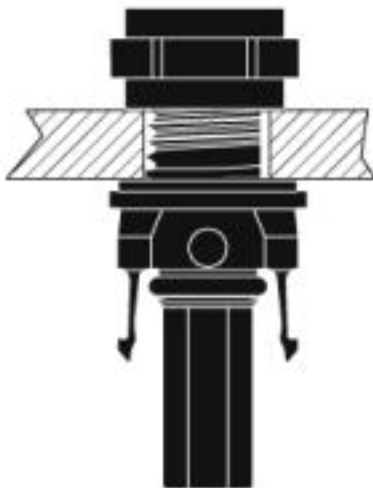

OUT+

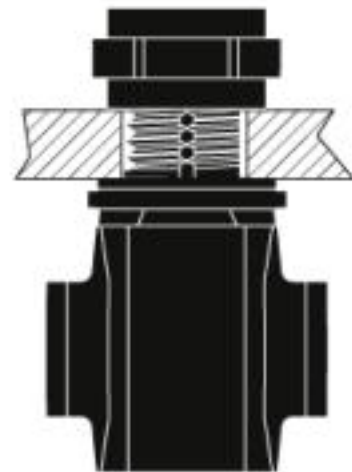

OUT-

Connection to the inverter

Classifications

eCl@ss

eCl@ss 10.0.1	27142422
---------------	----------

String combiner box (SCB) - SOL-SC-1ST-0-DC-3MPPT-1001 - 2404301

Classifications

eCl@ss

eCl@ss 5.1	27371890
eCl@ss 7.0	27142422
eCl@ss 8.0	27142422
eCl@ss 9.0	27142422

ETIM

ETIM 4.0	EC000816
ETIM 5.0	EC000268
ETIM 6.0	EC000268
ETIM 7.0	EC000268

Accessories

Accessories

Photovoltaic connector

Protective cap - PV-C PROTECTION CAP - 1785430

Photovoltaic connector, Range of articles: PV-JB TF, Protective cap, color: black, number of positions: 1



Connector - PV-CF-S 2,5-6 (+) - 1774674



Photovoltaic connector, Range of articles: PV-CF-S, Connector, housing material: PPE, color: black, number of positions: 1, min. conductor cross section: 2.5 mm², max. conductor cross section: 6 mm², rated current: 27 A, Connection method: Spring-cage, Type of contact: Socket. can only be released using a tool

Connector - PV-CM-S 2,5-6 (-) - 1774687



Photovoltaic connector, Range of articles: PV-CM-S, Connector, housing material: PPE, color: black, number of positions: 1, min. conductor cross section: 2.5 mm², max. conductor cross section: 6 mm², rated current: 27 A, Connection method: Spring-cage, Type of contact: Pin. can only be released using a tool

String combiner box (SCB) - SOL-SC-1ST-0-DC-3MPPT-1001 - 2404301

Accessories

Connector - PV-CF-S 6-16 (+) - 1790784



Photovoltaic connector, Range of articles: PV-CF-S, Connector, housing material: PPE, color: black, number of positions: 1, min. conductor cross section: 6 mm², max. conductor cross section: 16 mm², rated current: 40 A, Connection method: Spring-cage, Type of contact: Socket. can only be released using a tool

Photovoltaic Y-distributor - PV-ED6/Y-120(2+/1-) - 1030649



Photovoltaic connector, Photovoltaic Y-distributor, housing material: PPE, color: black. Assembled with SUNCLIX - 1x male (minus) - 2x female (plus); length of single cable 0.12 m, varying number of nodes and customer-specific cable lengths are available on request.

Connector - PV-CM-S 6-16 (-) - 1790797



Photovoltaic connector, Range of articles: PV-CM-S, Connector, housing material: PPE, color: black, number of positions: 1, min. conductor cross section: 6 mm², max. conductor cross section: 16 mm², rated current: 40 A, Connection method: Spring-cage, Type of contact: Pin. can only be released using a tool

Photovoltaic Y-distributor - PV-ED6/Y-120(1+/2-) - 1030650



Photovoltaic connector, Photovoltaic Y-distributor, housing material: PPE, color: black. Assembled with SUNCLIX - 1x female (plus) - 2x male (minus); length of single cable 0.12 m, varying number of nodes and customer-specific cable lengths are available on request.

Photovoltaic adapter set - PV-AS-MC4/6-150-MN-SET1 - 1079531

Photovoltaic connector, Photovoltaic adapter set, type: Adapter, color: black, rated current: 35 A, cable length: 150. Adapter pair (+- / -+), assembled with SUNCLIX - 1 x pin (minus) and MC4 - 1 x socket (plus) or with SUNCLIX - 1 x socket (plus) and MC4 - 1 x pin (minus), free cable length: 0.15 m, cable type: multi-standard (UL/PV1-F), customer-specific cable length available on request

Replacement plug

String combiner box (SCB) - SOL-SC-1ST-0-DC-3MPPT-1001 - 2404301

Accessories

Type 1/2 surge protection plug - VAL-MS-T1/T2 1000DC-PV-ST - 2801162



Replacement plug for PV arrester combinations from the VAL-MS-T1/T2 1000DC-PV-... product range

Phoenix Contact 2020 © - all rights reserved
<http://www.phoenixcontact.com>