

# **DAREX V290**

## **DRILL SHARPENER**

**1/8" (3mm) to 3/4" (19mm) size range**



## **OPERATING INSTRUCTIONS**

# Safety Instructions

## WARNING:

REMEMBER FOR YOUR OWN SAFETY, READ INSTRUCTION MANUAL BEFORE OPERATING TOOL AND SAVE THESE INSTRUCTIONS. Wear Eye Protection. Never touch internal parts of the sharpener when the sharpener is on. The rotating grinding wheel can cause injury. Use caution when replacing the grinding wheel. Follow instructions entitled "Replacing The Grinding Wheel", in this Instruction Manual. Regularly empty accumulated grinding dust. Follow instructions entitled "DAREX V290 Maintenance" in this Instruction Manual.

**WARNING:** WHEN USING ELECTRIC TOOLS, BASIC SAFETY PRECAUTIONS SHOULD ALWAYS BE FOLLOWED TO PREVENT THE RISK OF FIRE, ELECTRIC SHOCK AND PERSONAL INJURY, INCLUDING THE FOLLOWING:

1. KEEP GUARDS IN PLACE and in working order. Never perform grinding operation with the wheel cover removed.
2. REMOVE WRENCHES. Form a habit of checking to see that the wrench is removed from tool before turning it on.
3. KEEP WORK AREA CLEAN. Cluttered areas and benches invite accidents.
4. DON'T USE IN DANGEROUS ENVIRONMENT. Do not use power tools in damp or wet locations, or expose them to rain.
5. STORE EQUIPMENT in a safe place when not in use. Keep out of reach of children.
6. DON'T FORCE TOOL. It will do the job better and safer at the rate for which it was designed.
7. USE THE RIGHT TOOL. Don't force tool or attachment to do a job it was not designed for.
8. ALWAYS USE SAFETY GLASSES. Also use face or dust mask if cutting operation is dusty. Everyday eyeglasses only have impact resistance lenses, they are NOT safety glasses.
9. MAINTAIN TOOL WITH CARE. Keep tools sharp and clean for best and safest performance.
10. DISCONNECT TOOLS from the power supply before service.
11. AVOID ACCIDENTAL STARTING. Make sure switch is in the "OFF" position before plugging it in.
12. USE RECOMMENDED ACCESSORIES. Consult the owner's manual for recommended accessories. The use of improper accessories may cause hazards.
13. CHECK FOR DAMAGED PARTS. Before further use of the tool, a guard or other part that is damaged should be carefully checked to assure that it will operate properly and perform its intended function. Check for alignment of moving parts, binding of moving parts, breakage of parts, mounting and any other conditions that may affect its operation. A guard or other part that is damaged should be properly repaired or replaced.
14. DO NOT USE DAMAGED OR UNSHAPED WHEELS. Use grinding wheels suitable for speed of grinder.
15. NEVER LEAVE TOOL RUNNING UNATTENDED. Turn power off.
16. USE PROPER EXTENSION CORD. Make sure extension cord is in

good condition. When using an extension cord be sure to use one heavy enough to carry the current the Drill Sharpener will draw. An undersize cord will cause a drop in line voltage, resulting in a loss of power and/or overheating.

17. The continuous A-weighted equivalent sound pressure level at the operator's ear is not over 60 dB (A).
18. Risk of injury due to accidental starting. Do not use in an area where children may be present.
19. The weighted root mean square acceleration value to which the arms are subjected to does not exceed 2.5 m/s<sup>2</sup>

## GROUNDING INSTRUCTIONS

1. All grounded, cord connected tools:

In the event of a malfunction or breakdown, grounding provides a path of least resistance for electric current to reduce the risk of electric shock. This tool is equipped with an electric cord having an equipment-grounding conductor and a grounding plug. The plug must be plugged into a matching outlet that is properly installed and grounded in accordance with all local codes and ordinances.

Do not modify the plug provided-if it will not fit the outlet, have the proper outlet installed by a qualified electrician.

Improper connection of the equipment-grounding conductor can result in a risk of electric shock. The conductor with insulation, having an outer surface that is green with or without yellow stripes, is the equipment-grounding conductor. If repair or replacement of the electric cord or plug is necessary, do not connect the equipment-grounding conductor to a live terminal.

Check with a qualified electrician or serviceman if the grounding instructions are not completely understood, or if in doubt as to whether the tool is properly grounded.

Use only 3-wire extension cords that have 3-prong grounding plugs and 3-pole receptacles that accept the tool's plug.

Repair or replace damaged or worn cord immediately. See table 1 minimum gauge cord below.

2. Grounded, cord-connected tools intended for use on a supply circuit having a nominal rating less than 150 volts:

This tool is intended for use on a circuit that has an outlet that looks like the one illustrated in Figure A. The tool has a grounding plug that looks like the plug illustrated in Figure A. A temporary adapter which looks like the adapter illustrated in Figures B and C, may be used (except in Canada) to connect this plug to a 2-pole receptacle as shown in Figure B, if a properly grounded outlet is not available. The temporary adapter should be used only until a properly grounded outlet can be installed by a qualified electrician. The green colored rigid ear lug, etc. extending from the adapter must be connected to a permanent ground such as a properly grounded outlet box. See Fig. 1. Grounding methods below.

3. Grounded, cord-connected tools intended for use on a supply circuit having a nominal rating between 150-250 volts, inclusive. See Table 1. Minimum gauge for cord below.

Table 1.  
Minimum Gauge Cords

Ampere Rating		Volts	Total length of cord in feet			
		120 V	25 ft.	50 ft.	100 ft.	150 ft.
More Than		240 V	50 ft.	100 ft.	200 ft.	300 ft.
Not More Than		AWG				
0	618			16	16	14
6	10		18	16	14	12
10	12		16	16	14	12
12	16		14	12	Not Recommended	

<sup>a</sup> Only the applicable parts of the Table need to be included. For instance, a 120-volt product need not include the 240-volt heading.

Fig. 1.  
Grounding Methods

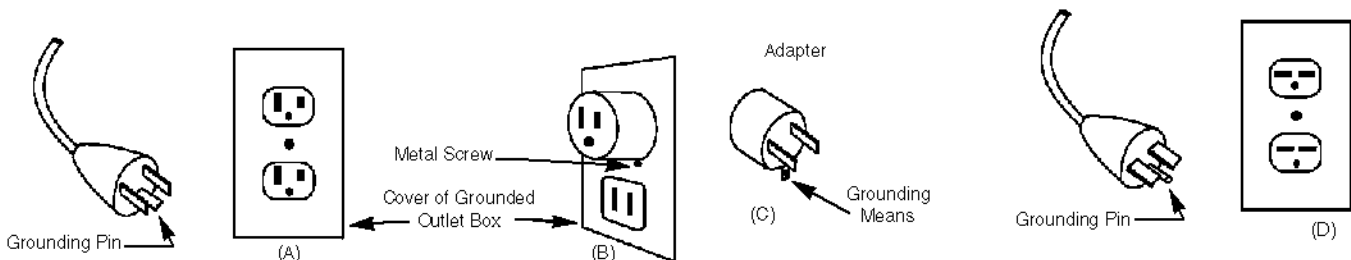

# Material Safety Data Sheet

US DEPARTMENT OF LABOR

Form Approved Occupational Safety and Health  
Administration OMB No 44-RJ 367

## MATERIAL SAFETY DATA SHEET

Required under USDL Safety & Health Regulations for Ship Repairing, Shipbuilding and Chip breaking  
129 CFR 1915, 1916.19171

### SECTION I

MANUFACTURERS NAME: Darex Industrial Corporation  
EMERGENCY PHONE NO (541) 488-2224  
ADDRESS: 220 Hersey Street, Ashland, Oregon 97520  
CHEMICAL NAME & SYNONYMS Diazon-Electroplated Diamond/CBN Products, Diamond (uncoated)  
Man-Made Diamond. RVG. MBG. MBS Product Families. Standard Series and 300 Series Diamond  
Micron Powder  
TRADE NAME & SYNONYMS: Electroplated CBN Wheels, Electroplated Diamond Wheels  
CHEMICAL FAMILY: Abrasive Any Grade  
FORMULA: n/a

### SECTION II COMPOSITION

CHEMICAL NAME	Nickel	Industrial Diamond
REGULATED	Yes	No
CAS#:	7440-02-0	7882-40-3
AGIH TLV	1.0 mg/m <sup>3</sup>	10.0 mg/m <sup>3</sup> (PNOG)
CARCINOGEN	Yes	No

Materials are regulated by OSHA 29 CFR 1910.1200, Hazard Communication Standard

### SECTION III - PHYSICAL AND CHEMICAL DATA

BOILING POINT (F)	n/a	MELTING POINT	n/a
SPECIFIC GRAVITY	n/a	VAPOR PRESSURE	n/a
VAPOR DENSITY	n/a	EVAPORATION RATE	n/a
SOLUBILITY IN WATER	n/a	SOLUBILITY IN ALCOHOL	n/a
		SOLUBILITY IN OTHER SOLVENT	n/a
		PERCENT VOLATILE BY VOLUME (%)	n/a

APPEARANCE AND ODOR Solid, Clear, White To Yellow To Dark Crystals Silver Color.

### SECTION IV - FIRE AND EXPLOSION HAZARD DATA

FLASH POINT	n/a		
(METHOD USED)	FLAMMABLE LIMITS	LEL	UEL
EXTINGUISHING MEDIA		n/a	
SPECIAL FIRE FIGHTING PROCEDURES:		n/a	
UNUSUAL FIRE AND EXPLOSION HAZARDS:		n/a	

### SECTION V - HEALTH, FIRST AID AND MEDICAL DATA

PRIMARY ROUTE(S) OF ENTRY: Inhalation, Ingestion, Skin, Eye(s)

#### EFFECTS OF OVEREXPOSURE

INHALATION: Difficulty in breathing (Dust from wheel use).

INGESTION: If a dust, symptoms are variable.

SKIN: Irritation (especially if sensitive to Ni).

EYE(S): Irritation (from Ni or diamond particle).

#### FIRST AID AND MEDICAL INFORMATION:

INHALATION: Move to fresh air. Give oxygen if necessary

INGESTION: Obtain medical attention.

SKIN: Wash thoroughly with water Obtain medical help if necessary

EYE(S): Flush thoroughly with water. Obtain medical assistance

#### OTHER POTENTIAL HEALTH RISKS

Nickel (Ni) is listed as a carcinogen Avoid long exposure. Consult medical personnel for first aid and medical information

### SECTION VI - CORROSIVITY AND REACTIVITY DATA

STABILITY:	Unstable ( )	Stable (x)
POLYMERIZATION:	May occur ( )	Will not occur (x)
INCOMPATIBILITY:	(Materials to avoid)	n/a
HAZARDOUS COMPOSITIONS PRODUCTS:		n/a
CONDITIONS TO BE AVOIDED:	Contact with strong acids/caustics, enclosed areas.	

### SECTION VII - SPILL, LEAK AND DISPOSAL PROCEDURES

STEPS TO BE TAKEN IN CASE MATERIAL IS RELEASED OR SPILLED: Normal clean up procedure

#### WASTE DISPOSAL METHOD:

Waste will contain nickel. Dispose  
in accordance with all applicable  
Federal, state, and local regulations.

### SECTION VIII - PERSONAL PROTECTION INFORMATION

#### RESPIRATORY PROTECTION:

Respiratory protection as needed  
see OSHA-29 CFR 1910.134

VENTILATION: LOCAL EXHAUST: strongly preferred

MECHANICAL (GENERAL): Use only if adequate to maintain below TLV's.

PROTECTIVE GLOVES: As desired by user.

EYE PROTECTION: Recommended see OSHA29 CFR 11910.215

OTHER PROTECTIVE EQUIPMENT: Use standard precautions for grinding operations.

### SECTION IX - STORAGE AND HANDLING PROCEDURES

#### NORMAL STORAGE AND HANDLING:

Store in clean, dry area, away from chemicals.

NORMAL USE: Use adequate ventilation (See Section VIII)

# The Darex Story

Darex Corporation began in 1973 in Beecher, Illinois. The D, A and R of Darex are the initials of three generations of the Bernard family; David, Arthur and Richard Bernard. David and his father Richard founded Darex. Grandfather Arthur Bernard, who earlier founded the Bernard Welding Company contributed his energy and guidance to Darex until his death. Art's inventions revolutionized the welding industry.

In 1978, Darex relocated to Ashland, Oregon. Grandson Dave and son Dick carry on Arthur's legacy of inventiveness. Darex grew to become the most recognized name in the cutting tool sharpening industry. Today, Darex is a world-leading manufacturer of precision cutting tool sharpeners.

Darex is proud to offer a complete line of quality precision cutting tool sharpeners at affordable prices. Before our first days, we at Darex had looked at our competitor's sharpeners and asked ourselves: "Must cutting tool sharpeners be complicated? Why must the choice in sharpeners have either cost prohibitive accuracy or low price inaccuracy?" Our sharpeners prove you can have it all: simplicity, accuracy and affordability.

We have always emphasized innovative product design and tested technology. The experienced personnel at our modern manufacturing facility use the latest production methods. The Darex marketing team knows first-hand the machines we sell and will guide you to the best machine for your needs. Our skilled technical service department is happy to answer your questions about our products or cutting tools.

## The V290

This limited duty unit is the most economically priced of the Darex Industrial Sharpeners. It is designed for the small fabrication or job-shop where a lower volume of drill sharpening is required. Point angle range is 118 to 140 degrees. Size range is 1/8" to 3/4" (3mm to 19mm). This sharpener has point splitting capabilities. With the standard electroplated CBN (Cubic Boron Nitride) grinding wheel the V290 will sharpen high-speed steel, cobalt, parabolic, TiN and other coated drill bits. An electroplated diamond wheel is available to sharpen carbide drill bits. The electroplated diamond and CBN wheel will sharpen approximately 2000 drills before replacement is required. The Darex V290 is most efficient when used to sharpen drill bits to their original point angle. The troubleshooting section of this manual is designed to anticipate many common questions and applications. To keep your DAREX V290 in top condition, please refer to the maintenance section of this manual. Replacement wheel and parts are listed on the parts list on page 11 and 12. A complete schematic breakdown of the machine is on the back page of the manual.

## Table of Contents

Page .....	1 Drill information
Pages .....	2 Machine Familiarization
Pages .....	3 & 4 Quick Step Instructions
Page .....	5 - 7 Detailed Operating Instructions
Page .....	7 Machine Adjustments
Page .....	8 & 9 Troubleshooting
Pages .....	10 Maintenance Instructions
Page .....	11 Parts List

# Drill Information

**118° STANDARD POINT:** This drill bit point angle is considered a standard general-purpose geometry. It is used for drilling soft or mild materials such as cold rolled steel, aluminum, and wood. Typically the standard drill bit is made of High Speed Steel (HSS). The tip of the drill bit can easily be split making it a high performance drill bit.

**135° HIGH PERFORMANCE SPLIT-POINT:** The flatter point angle of this drill is designed for harder, tougher materials such as tempered steels, hard alloys or hard cast metals. Due to the thicker web and flat point angle this drill point works best when its split-point is maintained.

**SPLIT POINTS:** Split point drill bits do not walk around on the material before they begin to cut. This feature is described as self-centering. Center punching or center drilling is often eliminated. A standard drill bit chisel point has to wear an area in the middle of the hole prior to the cutting lips removing material. Due to its additional cutting lips along the chisel edge, a split point will begin cutting immediately. Much less thrust is required to drill a hole with a split point as compared to a non-split or conventional point. You can split either the 118° or the 135° degree points on this DAREX V290 precision Drill Sharpener.

**CARBIDE DRILL BITS:** This point angle is typically 130° to 135°. Carbide is harder and more brittle than high speed steel and cobalt. This type of drill is used for drilling tempered steels, alloys, glass, etc. With an optional diamond wheel carbide drill bits can be sharpened on your DAREX V290 Drill Sharpener equipped with an optional diamond wheel.

**PARABOLIC AND COBALT DRILL BITS:** These drills have a thicker web than regular drill bits. Parabolic drill bits are designed to drill deep holes. Cobalt drill bits are for drilling tougher metals. They are extra thick in the center, (web) and have split points. Often these bits are Titanium Nitride coated. TiN is applied to increase a drill bits cutting efficiency. Most of these drill bits can be sharpened with your DAREX V290 Drill Sharpener.

**LIP RELIEF ANGLE:** The relief on a drill bit is the downward angle between the cutting lips (leading edge) and the heel (trailing edge) on the drill point. If the drill bit cutting lips are not higher than the heel, then the drill bit will not cut into the material. This is often referred to as negative relief (see page 6). The DAREX V290 Drill Sharpener is designed to grind a standard factory relief on your drill bits.

**CHISEL EDGE ANGLE:** The chisel edge is the line across the point of a drill bit. Note that in the drawing (seen at right) the chisel edge angle is between 120° and 135°. Another way to look at this is to imagine the drill point as a clock face. With the cutting lips horizontal, the chisel edge should point to the 1 and 7 o'clock positions. This is the most common drill bit chisel angle.

**WEB:** The web is the core thickness of a drill point. A new drill is typically around 18% of the drill bit diameter. As a drill bit is sharpened and becomes shorter the web thickness will increase. Splitting the point or thinning the web on a drill bit will maintain drill bit performance.

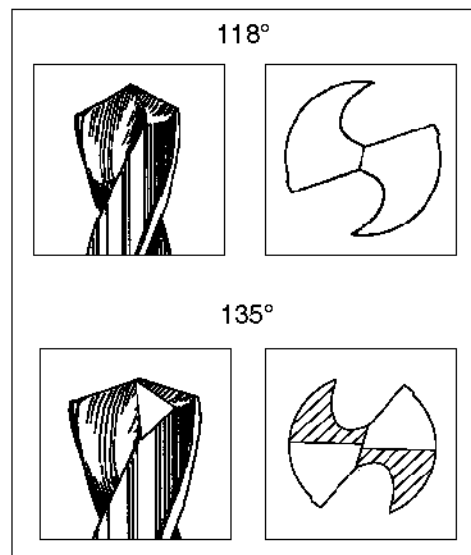

## ANATOMY OF A DRILL BIT

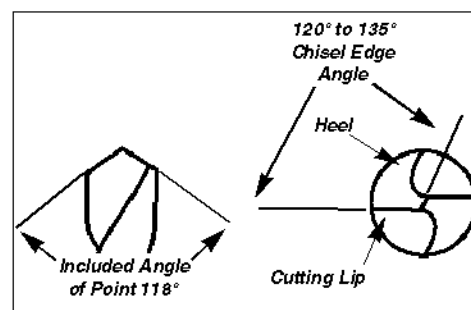
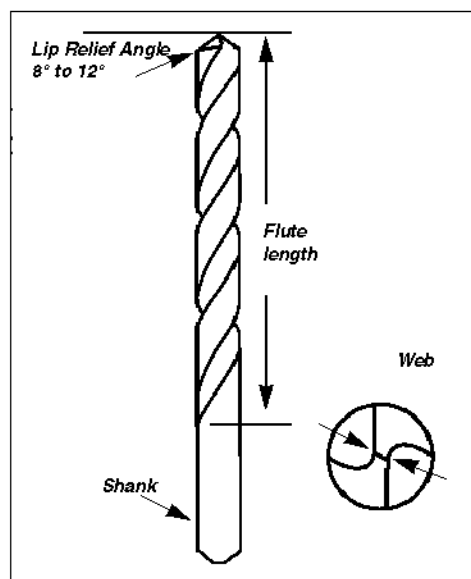

# GETTING TO KNOW YOUR V290

## Before you sharpen your first drill bit

Please take a few minutes to familiarize yourself with your new DAREX V290 Drill Sharpener and its basic parts and features (shown below). The time it takes to read this page and the remainder of the manual will be made up when you sharpen your first drill bits.

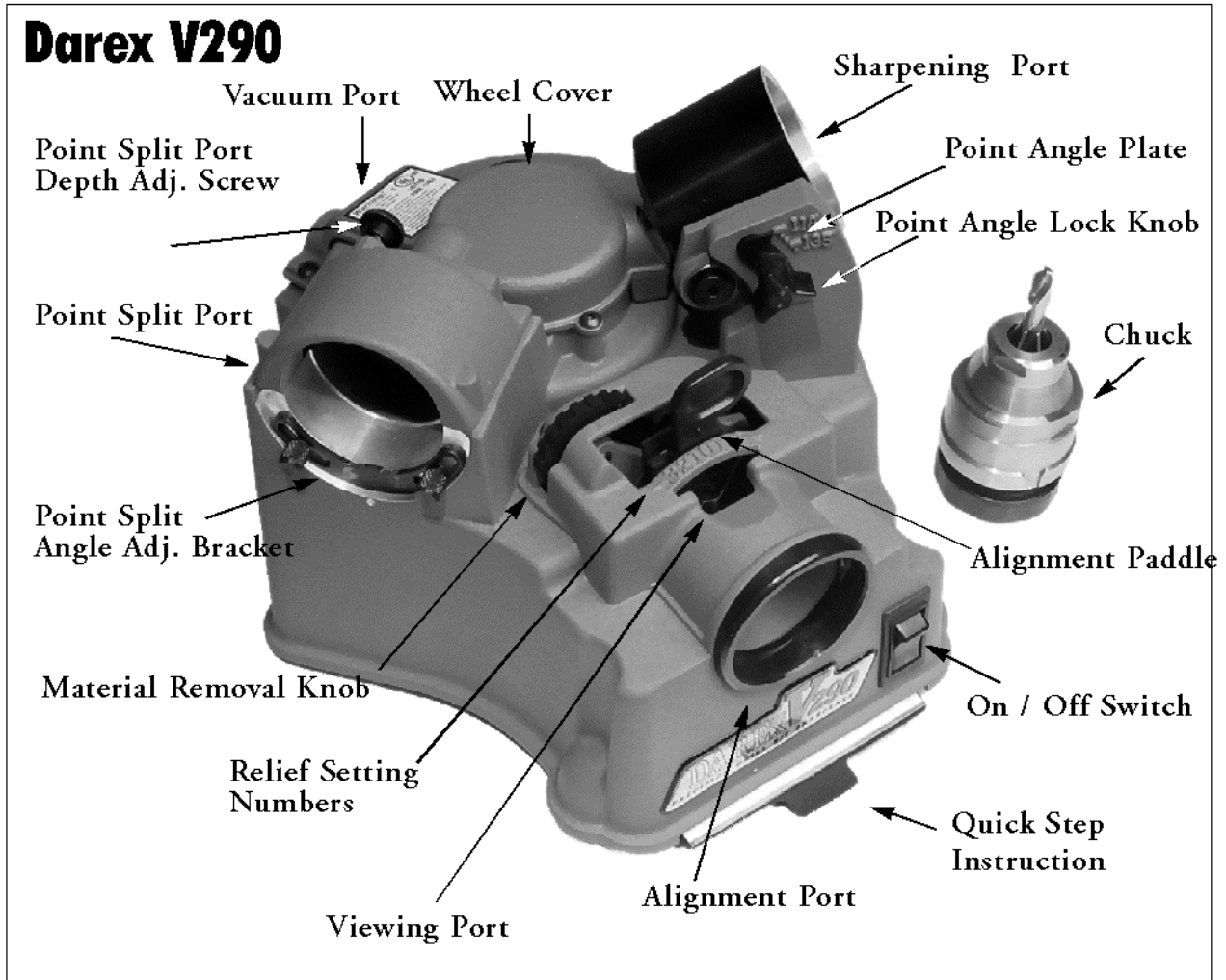

## Specifications

- ◆ Sharpen: Two flute twist drill bits SAE and metric. HSS, Cobalt, TiN coated. Parabolic. Reduced shank drill bits. Carbide drill bits require the optional diamond wheel. Unlimited drill bit length.
- ◆ Capacity: 1/8" to 3/4", 3mm to 19mm
- ◆ Accuracy: ANSI Standards.
- ◆ Wheel care: Does not require coolants. Wheels are superabrasive and electroplated and do not require truing or dressing.
- ◆ Cycle time: Typically a 1/8" drill bit can be sharpened within 15 seconds and a 3/4" drill bit will take up to 60 seconds. Material removal is adjustable.
- ◆ Motor: 115 volt, 4.5 amp, 60hz, 3450 RPM, made in USA
- ◆ Machine dimensions: 12" x 11" x 9"
- ◆ Packing dimensions: 17" x 15" x 11.5"
- ◆ Weight 18 lbs. (8.2 kg)
- ◆ Shipping Weight: 24 lbs. (11 kg)
- ◆ Operating ambient temperature range: 4 - 35C (40 - 95F)

# QUICK STEP INSTRUCTIONS

(Detailed instructions start on page 5)

## A SELECT POINT ANGLE

1. Determine angle of your drill bit (A-1)
2. Set point angle from 118 to 140 degrees (A-2).
3. Set relief paddle to +1 for 118 or -1 for 135-degree point angles. These are starting reference values, settings may need adjustment. (A-3)
4. Set material removal knob from 1 to 4. Approximate removal per digit .005 inch. (A-4)

## B ALIGN DRILL BIT

1. Insert drill bit into chuck and close down jaws until drill is supported but free to turn.
2. Push the relief paddle backward to open the pawls. (B-1)
3. Position flat on chuck nose at 12 o'clock. Insert the chuck into alignment port engaging flat on nose of chuck with flat in alignment port. (B-2)
4. Push drill bit all the way to the back so it touches the drill stop.
5. Release the paddle and rotate the drill until the pawls grip inside the flutes. (narrowest width of drill)
6. Make sure drill tip is up against stop, tighten the chuck. Remove from the port.

## C SHARPEN DRILL BIT

1. Turn power switch to on.
2. Position the flat on the nose of the chuck to the one o'clock position; insert the chuck into the sharpening port with a slight lifting motion. (C-1)

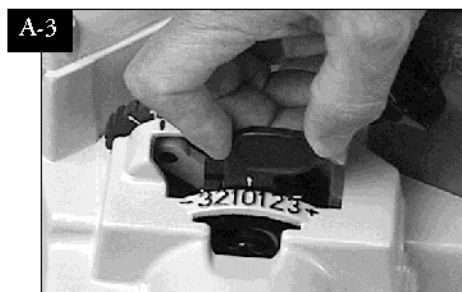
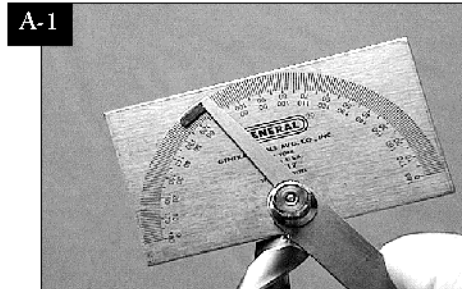

**TIP:**

**Check the point angle indicator and make sure that it is set to the same angle as the drill point.**

3. Rotate the chuck clockwise in half rotation increments, keeping consistent, slight downward and inward pressure on the chuck. Let the cam drive the natural in and out motion.

4. Continue rotating the chuck until the grinding is complete, then remove the chuck from the sharpening port.

5. Inspect the drill. It may be necessary to repeat steps B and C to complete grinding of the drill point.

Note: do not remove the drill from chuck if the point is to be split. Proceed to step D to create a split point drill bit.

### D SPLIT DRILL BIT

1. Insert chuck into the split port with the milled notch (D-1) on the chuck aligned with the tab on the split angle adjustment ring. (D-2)

2. Ease the chucked drill bit into the wheel until the chuck hits the depth stop. (D-3) Hold for a "one count."

3. Pull chuck out far enough to rotate 180 degrees. Push chuck slowly back into the wheel for the "one count", splitting the opposite side.

4. Inspect the drill bit. If you wish to increase the split depth, adjust the point split depth adjustment knob clockwise and re-split.

5. If you wish to decrease the split depth, it must be re-sharpened before adjusting the point split depth adjustment knob counter-clockwise and re-splitting.

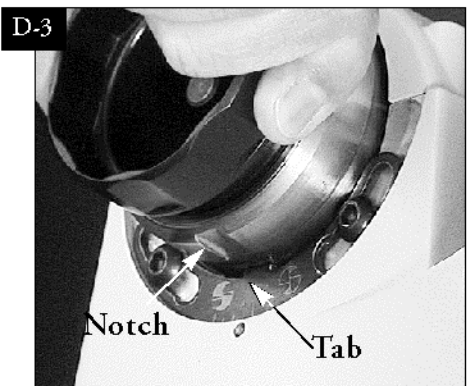
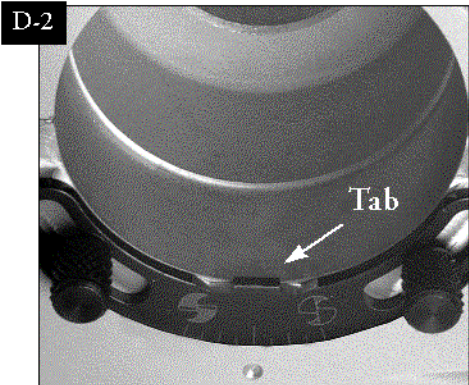
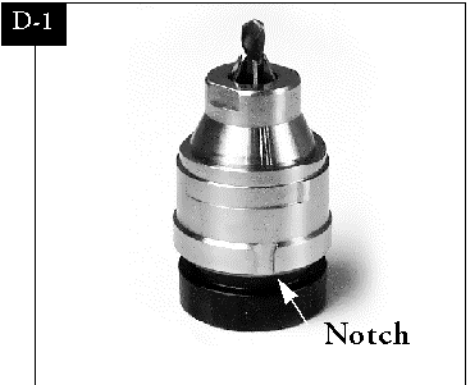
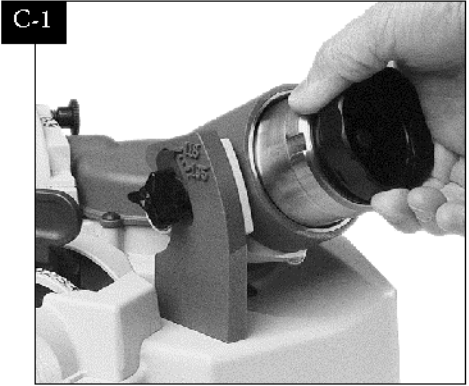

### **TIP:**

**Apply light, steady pressure while sharpening the drill to prevent excessive heat and wheel wear.**



# DAREX V290 Detailed Instructions

If possible, the first couple of drill bits you sharpen should be about 3/8" in diameter, or a large enough drill bit to see the detail of the point. Study the V290 familiarization diagram on page 2 and the drill information on page 1. Various drill bit facts and drill sharpener nomenclature will be referenced in these sections.

## STEP 1: Drill angle identification and sharpener set up

- A. Place the drill in a point angle gauge or mechanic's protractor. Note how the cutting lips fit in the gauge. A correct fit is when the protractor edges are set flat along the entire cutting edge. (See picture #1)
- B. The reading from the gauge will be the angle set on the sharpener point angle plate. Loosen the point angle lock knob and set the sharpening port to the same angle as the drill point. Note: You may change the drill point to a different angle than your drill tip if you wish. ( See picture # 2 )
- C. The Alignment Paddle is set to achieve heel relief. It will be set at different settings as you sharpen drill bits with different helix angles. If your drilling operation requires more relief for faster drilling or drilling softer material (usually 118 degree point) Set the alignment paddle to the "plus" (+) direction at one (1) or two (2). If more accurate holes are required or harder material is being drilled, (135 degree point angle) set the alignment paddle at the minus (-) direction at one (1) or two (2). The alignment tube is now set to "time the drill bit". ( See picture # 3 )
- Note: For more information on increasing or decreasing "relief" on a drill bit, ( see page 6, Step 3 ) "About Relief Settings" for more discussion and applications.
- D. Set the material removal knob to #1 mark. (See Picture # 4 ) At this minimal setting the material removal will be approximately .005" to .010". Each number past #1 on the knob will add another .005" removal to the setting. If the cutting lips are very dull or chipped, more material will need to be removed.

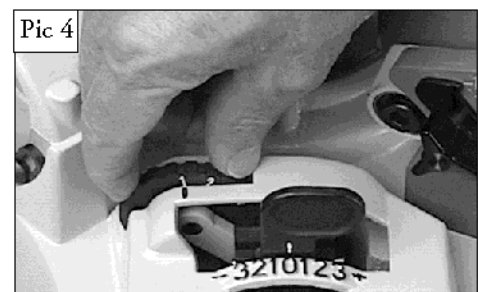
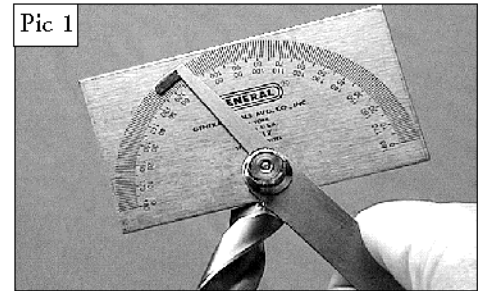

## STEP 2: Aligning the drill bit for sharpening

- A. Turn the chuck knob counter-clockwise (CCW) to open the chuck jaws, until you can insert the drill bit into the chuck. Once the drill bit is inserted into the chuck, turn the chuck knob clockwise (CW), this will close the chuck jaws onto the drill. Turn the chuck knob until it stops, then loosen the chuck jaws slightly by turning the chuck knob CCW. At this stage the drill bit should have a "slip-fit" and will slide in or out and rotate freely within the chuck. ( See Picture # 5 )



NOTE: If the drill bit is held in the chuck too tightly during the alignment process, you might not achieve proper alignment.

B. Push the paddle back all the way to the rear and hold it there. Align the flats on the chuck with the flats in the alignment port. Slide the chuck into the alignment port all the way until it stops. (See Picture # 6) At this point the flat on the chuck nose should be entirely hidden inside the alignment port.

C. Grasp the shank of the drill bit and push it into the chuck to the drill stop. ( See Picture # 7 )

D. Release the paddle, but continue pushing the drill bit in against the stop. The two pawls will close onto the drill bit. ( See picture # 8 )

NOTE: Short drill bits may be aligned first without the chuck. After aligning the short drills, slip the chuck over the drill bit and into the alignment port and tighten the chuck jaws, securing the drill bit. Before removing the chucked drill bit from the alignment port compare the position of the drill bit against the pawls with the "correct" illustration on this page. ( See Picture # 8 )

E. Look down into the viewing port in front of the paddle. Note the location of the two spring steel pawls. Rotate the drill bit until the pawls slip in and grab the flutes at the narrowest point. (See picture #8 and the sketch below it.) Continue to push the drill bit against the drill stop.

F. With the drill point against the drill stop and the pawls in the flute of the drill, use the other hand to tighten the chuck by turning the chuck knob clockwise. Push the paddle back again to release the drill bit and remove the chuck and drill from the alignment port. Snug the chuck knob clockwise using both hands to secure the drill bit.

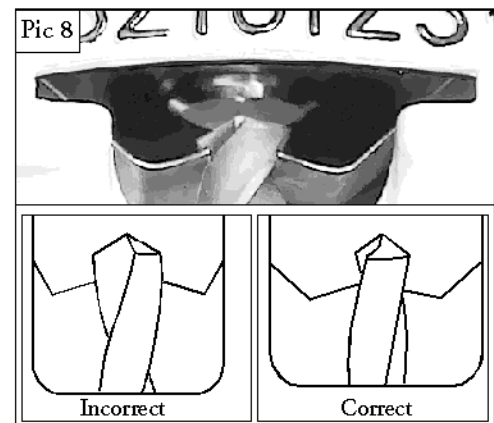
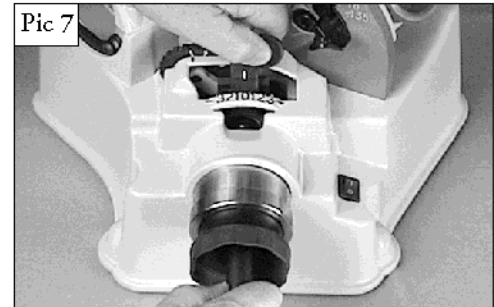
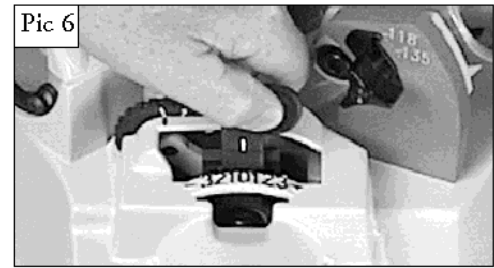

### STEP 3: Sharpening the drill point

A. Push the Drill Sharpener switch to the ON ( | ) position.

B. Insert the chuck into the sharpening port. While lightly pushing in and down, rotate the chuck clockwise in half rotation increments. The chuck will move in and out and the sharpening port will slightly swing during this process. Let the cams on the chuck dictate the natural in and out sharpening motion. (See Picture # 9)

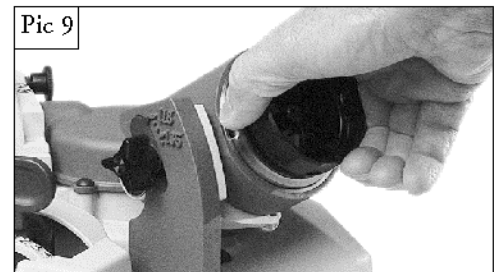

NOTE: The sharpening port is swinging due to the cam on the chuck riding against the cam follower bearings. DO NOT LIFT THE CHUCK UP AS YOU ROTATE IT. The initial grinding occurs when the "valley" of the feed cam rides against the in-feed cam bearing. ( See Picture # 10 ) Once the grinding becomes quiet (sparks out) the sharpening is complete. Inspect the drill point and if it does not have adequate relief see the next paragraph. DO NOT REMOVE THE DRILL FROM THE CHUCK IF THE POINT IS TO BE SPLIT.

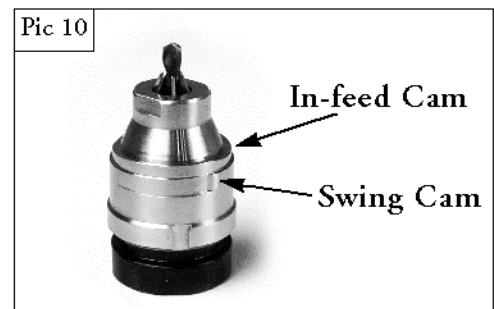

#### About Relief Settings

After aligning and sharpening the drill bit, if the relief needs to be increased or decreased, then the following procedure is required.

A. Rotate the alignment paddle from "0" to the "plus" side numbers of # 1. , # 2. or # 3. to increase the relief setting. The further right the paddle is moved, the more relief the drill will have after aligning and sharpening.

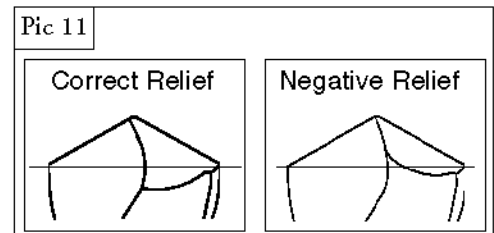

- B. To decrease relief, move the paddle left to the “Minus” side at the #1, #2 or #3 location. The further left the paddle is moved, the less relief the drill will have after aligning and sharpening.
- C. Reference the diagram #11 in the “Detailed Instructions” section on page 6.

## STEP 4: Splitting the drill point

You can split any drill point that the V290 is capable of sharpening. See below “Point Split Port Adjustment” diagrams and definition of a properly split drill point.

- A. Once the drill is sharpened, do not remove it from the chuck. Align the notches on the chuck with tab in the point splitting adjustment bracket. Make sure chuck is held in-line and squared up with the point split port. (See Picture # 12 & 13)
- B. Slide the chuck into the grinding wheel for a “one count” pull the chuck of the splitting port, about 1/2 inch and rotate it 180 degrees. Repeat “B”.
- C. Use the point splitter depth adjustment screw to feed the drill bit into the wheel. (See picture # 14)

### Point Split Port Adjustment:

What to do if the drill point is split too much or too little:

The point split depth is adjustable. The point split adjustment screw is located at the rear of the point splitter (See picture # 14). If the drill point is changed at the sharpening port then a slight adjustment under the following notes will need to be made.

- ♦ Drill point is split correctly (See diagram “B”) Use the position of the “split line” on the right side of the drill bit as the reference line. Compare the position of the right “split line” to the left “split line”. If the “split line” on the right is lower than the “split line” on the left, the drill bit is under-split or split too little. (See diagram “A”). If the “split line” on the right is higher than the “split line” on the left, the drill bit is over-split or split too much. (See diagram “C”).
- ♦ Drill point is split too little. ( See Diagram “A” ) Turn the adjustment screw counterclockwise, (unscrew). Each mark on the sleeve of the screw will move the drill .002”. Rotate the adjustment screw one half of a line, at a time, in the point split adjustment process. Re-split the point, then check the results.
- ♦ Drill point is split too much. (See Sketch “C”) The drill will need to be realigned and resharpened prior to adjusting the point split port. Once the drill is resharpened, turn the point split adjustment knob clockwise approximately one line. Insert the drill into the point split port and split both sides of the drill. Inspect the drill point. If the split is now not deep enough then rotate the adjustment screw coun-

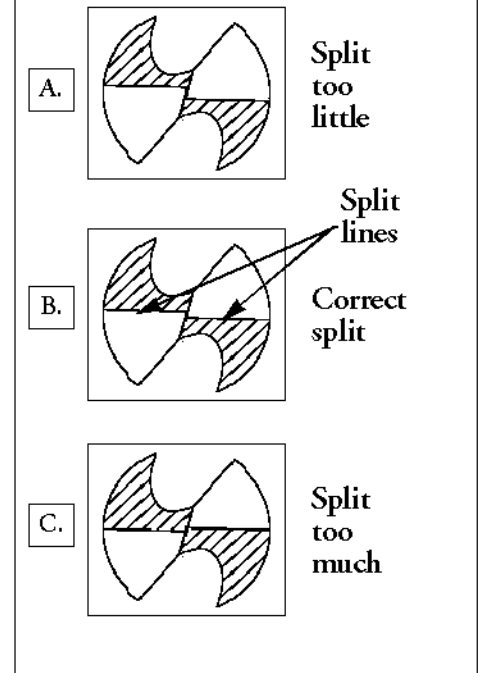
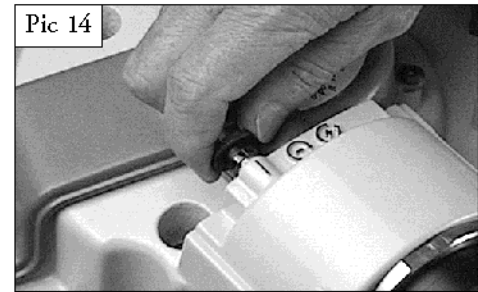
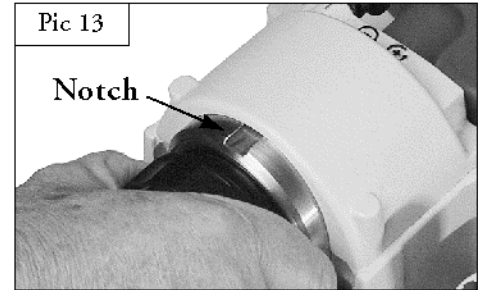
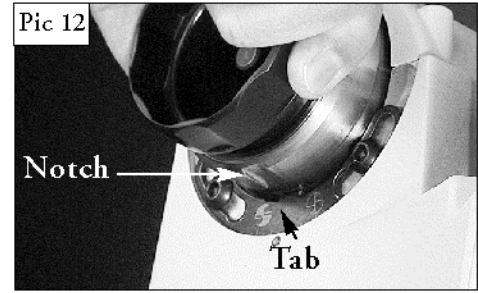

### TIP:

**When adjusting the Point Split Port make sure to leave .002" to .005" between the split areas.**

terclockwise (unscrew it ), one half of a line. Resharpen, then split the drill point again and check to see if split is correct, if not, adjust accordingly.

**Split Angle Adjustment:** If the chisel angle of the drill has changed due to the relief ground on the drill, then the point split rotational angle may need to be changed. To adjust the split rotational angle, loosen the two thumb screws, (See Picture #15), that hold the adjusting bracket on the face of the point split port. Slightly move the bracket to the left about one mark clockwise. This will increase the split angle that is required if the relief has been increased. Move the bracket to the right, counterclockwise, if the relief has been reduced. The key to this process is to intersect or remove the chisel line when splitting the drill point. ( See Diagram #15a and #15b)

## TROUBLE SHOOTING

**Q:** I aligned the drill bit and sharpened it, but no material gets removed, why ?

- ◆ You may have allowed the paddle to knock the drill bit back into the chuck. Carefully realign the drill bit in the alignment port again. Making sure the drill bit is pushed all the way against the drill stop.
- ◆ You may not have tightened the chuck tight enough to hold the drill bit in place. When the drill bit hit the wheel it was pushed back into the chuck. Realign the drill bit again using more force to tighten the jaws on to the drill bit.
- ◆ When changing point angles it may be required to advance the Material Removal Knob to a higher number. Realign drill bit at new Material Removal Setting.

**Q:** I'm getting negative relief! Negative relief is present when the heel behind the cutting lip is higher than the cutting lip on the drill bit. When negative relief occurs the drill bit will not cut.

- ◆ To correct this problem, move the paddle toward the right, try number 2 or 3 for an increased relief setting. Realign the drill bit and resharpen.
- ◆ Maintain consistent inward pressure on the chuck during the sharpening process. Make sure grinding is completed and the drill bit has been sparked out. (Grinding noise reduced to a minimum)
- ◆ The Material Removal Knob may be set to remove too much material. Reduce amount of material being removed from the end of the drill bit by setting the Material Removal Knob to a lesser number. Realign drill bit and sharpen.

**Q:** Why is the drill point off center? If the tip of the drill bit appears to be sharpened off center, check the following items:

- ◆ Make sure that there are no particles between the chuck jaws and the drill bit, which could hold it off center.
- ◆ Make sure the closing knob is tightened firmly enough to hold the drill bit on center.
- ◆ During the sharpening process be sure not to push unevenly while rotating the chuck.
- ◆ The drill may be bent. Roll it on a flat surface to check for straightness.
- ◆ Spark out the drill bit.

**Q:** Why don't my drills align correctly, like the "correct" diagram?

- ◆ There may be a burr on the drill shank (remove burrs with a flat file).
- ◆ The drill may be too loose or too tight in chuck.

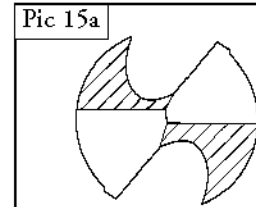
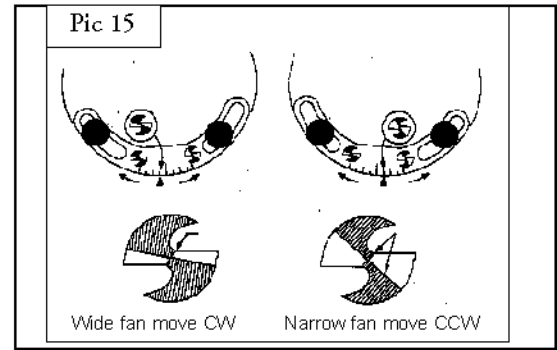

Incorrect

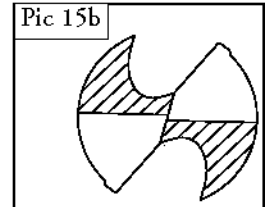

Correct

### TIP:

Periodically clean the grindings from inside the chuck to make sure it will maintain accuracy.

### TIP:

To sharpen very small drills, set the material removal at the smallest (#1) amount of material removal.

### TIP:

While aligning the drill, make sure that the spring steel pawls are fully inside the flutes of the drill.

**Q:** What can I do about the flat spot between the lip and the heel?

◆ The flat spots or chattering on a sharpened drill, is the result of an incomplete or irregular rotation of the chuck in the sharpening port. To correct, apply firm, not excessive inward pressure and rotate the chuck smoothly while sharpening. Do not lift up on the chuck while rotating it. Be sure to complete the grind.

**Q:** The chisel edge on my drill bit is too long and flat!

◆ During the alignment process the pawls were not gripping "ON" the flutes of the drill bit. Re-align the drill bit making sure that the pawls are centered in the flutes.

◆ Too much heel relief. Realign drill bit toward the minus setting and resharpen.

**Q:** After sharpening, the grind finish on my drill is rough!

◆ Grind finish is initially rough when sharpened on a new wheel. Drill performance will not be noticeably affected. However, the finish will improve as the crystal surfaces wear evenly.

◆ Rotating the chuck too fast in the sharpening process can create a rough finish.

**Q:** Why is my point split uneven?

Pictures on page 7, "Point Splitter Adjustments" show drill points that are split, "Too little", "Too much", and a drill point that is "Correctly split".

◆ To correct an uneven point split, take more material off of the under split flute. To do this, reinsert the chuck in the splitting tube with the under split side down. Repeat procedure on page 7 - Step B, to correct the split. A correct split point should look symmetrical. The two parallel lines formed by the split should have a separation of .002" to .005" on the chisel angle.

**Q:** Can I sharpen left-hand drill bits?

◆ Not with this unit. However, Darex Industrial does offer other precision drill bit sharpeners that will sharpen left-hand drill bits. They can be reached at 1-800-547-0222 or online at <http://www.darex.com>.

**Q:** Motor stops running, won't restart!

The motor will shut off when the following occurs:

◆ The wheel is jammed and the motor is stalled. Push the On/Off switch to "OFF" and unplug the electrical cord. Remove the wheel cover and check to see if the wheel rotates freely. Make sure that all grindings are cleaned out and no obstructions are in the wheel cavity area. Once this is done and the wheel turns freely, plug the machine back in to the electrical receptacle and follow the restarting procedures.

◆ The machine is tipped at an angle or is turned over.

◆ An extreme voltage change occurs to the motor.

◆ Too heavy of use for an extended time, the motor overheats.

◆ If the motor is short-circuited for any reason.

When the motor shuts off from any of the above reasons, reset the on/off switch to "ON". The motor should restart. If motor does not start allow the unit to cool down for approximately 30 minutes.

Then push the "ON" switch again.

**NOTICE:** The V290 Drill Sharpener is equipped with multiple safety features which turn the motor off when certain occurrences happen to the machine. For example, turning the machine on its side will cause the circuit breaker to trip. Machine must be placed upright.

If the unit won't start by following the above procedures call Darex Corporation at 1-800-547-0222 and ask for Technical Service.

 **TIP:**

**If the chisel angle on the tip is too far clockwise, realign the drill with a reduced relief setting.**

 **TIP:**

**Clean CBN and diamond wheels with an oil-less solvent, for example automotive break cleaner.**

 **TIP:**

**Sparking out drill bits while sharpening improves drill point concentricity.**

 **TIP:**

**Darex manufactures other sharpeners capable of creating a variety of specialty points.**

# DAREX V290 MAINTENANCE

## Cleaning the DAREX V290

Unplug the Drill Bit Sharpener. Using a dry paintbrush or a cloth, clean the inside and outside of the Alignment, Sharpening and Splitting ports to remove any grindings that may have accumulated. (See picture # 16)  
The attachment of a vacuum with a standard vacuum hose works well to keep the grit area clean. (See "Vacuum Tube" below)

## Removing the wheel cover

Unplug the Drill Bit Sharpener. Using a 3mm hex wrench, remove the three hex head screws holding the wheel cover on. (See Picture #17)  
Lift the wheel cover off and with a dry brush remove any grinding dust. ( See picture # 18 )

## Determining if a wheel change is required

1. Sharpened drill bits will burn or turn blue no matter how fast or slow you rotate the chuck.
2. Upon inspecting the wheel, it appears smooth as if there is no abrasive. (See "Cleaning the electroplated CBN or diamond wheel" )
3. When sharpening a drill bit, if it takes an extreme number of rotations to sharpen the tool, then the wheel will need to be replaced. Contact the company or distributor where the sharpener was purchased for replacement wheels.

## Removing the wheel

**MAKE SURE THE UNIT IS UNPLUGGED!** Once wheel cover is removed, insert a phillips head screw driver into the wheel retainer bolt on the top of the wheel and turn it counterclockwise to loosen. (See picture #19) Using a hex wrench remove the bolt and wheel retainer. Lift the wheel off of the motor hub. (See Picture #20) Remove dust particles from the wheel hub and grinding wheel area with a small dry brush. Dispose of drill grinding dust in a safe and environmentally approved manner. Prior to re-installing the wheel make sure to clean all grindings off of hub and wheel.

## Replacing the wheel

To re-install wheel, reverse steps taken to remove wheel. (See Pictures # 17, 18, 19, & 20)

## Cleaning the electroplated CBN or diamond wheel

These wheels are maintenance free. No truing or dressing is required on these type of wheels. However, wheels should be cleaned on a routine basis. After removing the wheel from the unit, saturate with any type of oil-less solvent, such as Automotive Brake Cleaner. If you wish to, you can use a soft bristle brush and lightly brush the wheel after saturation, re-saturate the wheel to remove any debris that was loosened.

**NOTE:** If the wheel performs as though it needs changing, it may just need cleaning.

## Cleaning the chuck

Using pressurized air, blow grindings out of the chuck from the knob end. For further cleaning, disassemble the chuck by merely unscrewing the closing knob on the chuck and removing the chuck body. Clean the inside of the chuck with a dry paintbrush. Do not remove the springs and jaws from the holder! Once the inside of the chuck has been cleaned, apply a drop or so of light lube on the threads. Slide the chuck body onto the jaws, rotate the closing knob clockwise to reassemble the chuck.

(See pictures # 23 & 24)

## Vacuum tube

If a vacuum system is available it is strongly recommended to attach the air vacuum tube to the exhaust of the sharpening port. To attach the tube:  
Unplug the machine. Remove the wheel cover screws and remove the vacuum port plug. (See picture # 21). Insert the vacuum tube into the groove in the port (See picture #22). Re-install the screws that hold the wheel cover down. Attach a vacuum source to the 1-1/4" diameter tube.

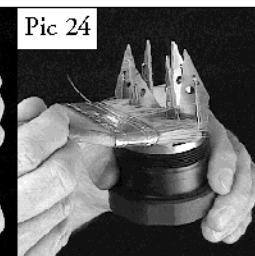
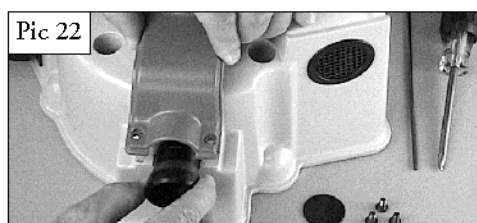
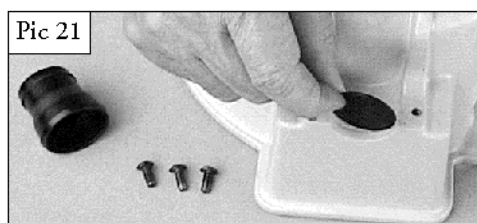
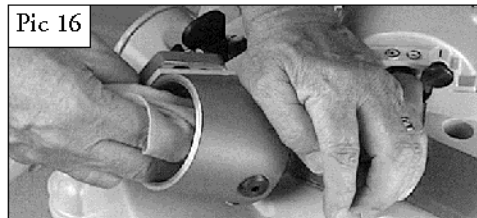

**DAREX**

<http://www.Darex.com>

**V291**

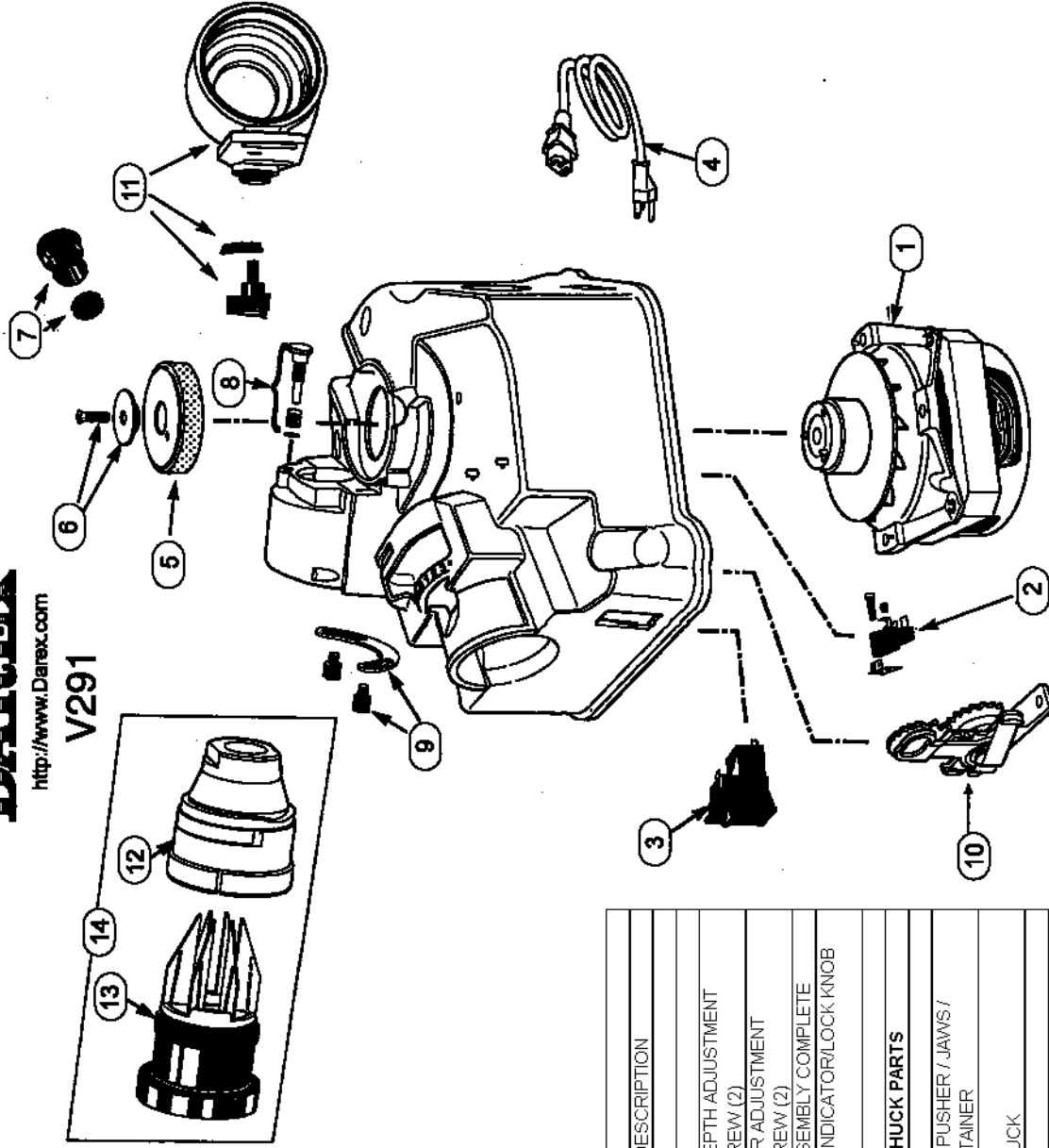

DAREX V291 DRILL SHARPENER REPLACEMENT PARTS LIST		
ITEM #	DESCRIPTION	ITEM# DESCRIPTION
<b>MOTOR</b>		
1	MOTOR 220V ASSY. **	1 MOTOR 220V ASSY. **
2	MOTOR RELAY 220 V	2 MOTOR RELAY 220 V
3	SWITCH 220V	3 SWITCH 220V
4	220V POWER CORD	4 220V POWER CORD
<b>WHEEL</b>		
5	GRINDING WHEEL CBN	5 GRINDING WHEEL CBN
	GRINDING WHEEL DIAMOND (OPTIONAL)	6 GRINDING WHEEL DIAMOND (OPTIONAL)
6	GRINDING WHEEL RETAINER/BOLT	6 GRINDING WHEEL RETAINER/BOLT
7	AIR VACUUM TUBE /PLUG	7 AIR VACUUM TUBE /PLUG
<b>CHUCK PARTS</b>		
		12 CHUCK BODY
		13 CHUCK KNOB / PUSHER / JAWS / SPRINGS / RETAINER
		14 3MM - 18MM CHUCK
<b>OPERATORS GUIDES</b>		
		V291 OPERATORS MANUAL GERMAN
		V291 OPERATORS MANUAL FRENCH
		V291 OPERATORS MANUAL ENGLISH
<b>** SHIP TO DAREX FOR FACTORY INSTALLATION</b>		