

FIXED 2.5 AND 5 VOLT MINIATURE VOLTAGE REGULATORS

ISSUE 3- FEBRUARY 1998

ZMR SERIES

DEVICE DESCRIPTION

The ZMR series of three terminal fixed positive voltage regulators feature internal current limit and will shut down under thermal overload conditions making the devices difficult to destroy.

The circuit design offers an exceptionally low quiescent current, only 30µA for the 2.5 volt device, ideal for low power applications. The initial devices in the series regulate to 2.5 or 5 volts with a drive capability up to 50mA, however, the flexible design will allow other voltage selections to be made.

The device is designed with space saving in mind and is available in the small outline SOT23 package as well as SOT89 for higher power applications. The SOT23 package is ideal for applications where space is restricted. The device is also available in through hole TO92 package.

FEATURES

- Small outline SOT23 and SOT89 packages
- TO92 package
- 2.5V and 5V output
- 22.5V maximum input voltage (ZMR25H)
- 25V maximum input voltage (ZMR50H)
- Output current up to 50mA
- Very low Quiescent current (30µA)
- Unconditionally stable
- Other output voltages possible
- Internal short circuit current limit

VOLTAGE RANGE

ZMR250	2.5V
ZMR500	5.0V
ZMR25H	2.5V
ZMR50H	5.0V

SCHEMATIC DIAGRAM

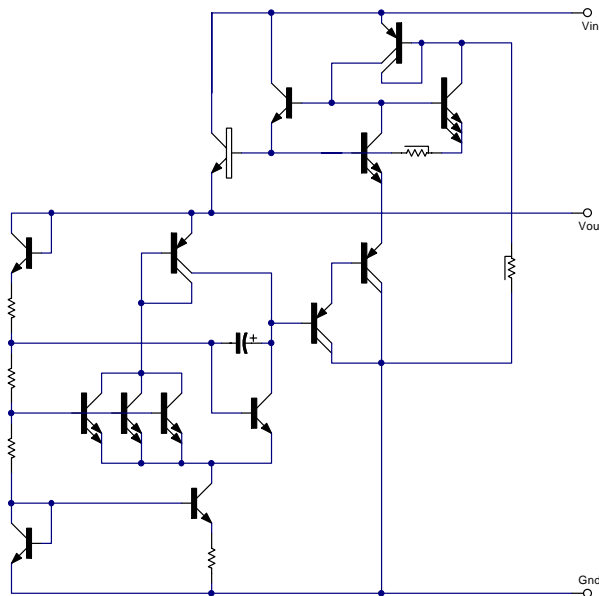

ZMR SERIES

ABSOLUTE MAXIMUM RATINGS

Input voltage (ZMR25H) (ZMR50H)	22.5V 25V	ZMR250 ZMR500	20V 20V		
Package power dissipation ($T_{amb}=25\text{ }^{\circ}\text{C}$)		SOT23 TO92	500mW (Note 3) 600mW	SOT89	1.5W (Note 3)
Output current (I_O)			100mA		
Operating temperature			-55 to 125 $^{\circ}\text{C}$		
Storage temperature			-65 to 150 $^{\circ}\text{C}$		

Note:

1. The maximum operating input voltage and output current of the device will be governed by the maximum power dissipation of the selected package. Maximum package power dissipation is specified at 25 $^{\circ}\text{C}$ and must be linearly derated to zero at $T_{amb}=125^{\circ}\text{C}$.
2. The following data represents pulse test conditions with junction temperatures as indicated at the initiation of the test. Continuous operation of the devices with the stated conditions might exceed the power dissipation limits of the chosen package.
3. Maximum power dissipation, for the SOT23 and SOT89 packages, is calculated assuming that the device is mounted on a ceramic substrate measuring 15 x 15 x 0.6mm.

ZMR25H

ELECTRICAL CHARACTERISTICS

TEST CONDITIONS (Unless otherwise stated): $T_j=25^{\circ}\text{C}$, $I_O=10\text{mA}$, $V_{in}=6.5\text{V}$

SYMBOL	PARAMETER	CONDITIONS	MIN.	TYP.	MAX.	UNITS
V_O	Output Voltage		2.438	2.5	2.563	V
		$I_O=0$ to 50mA $T_j=-55$ to 125 $^{\circ}\text{C}$	2.360		2.640	V
		$V_{in}=4.5$ to 22.5V $I_O=0$ to 50mA $T_j=-55$ to 125 $^{\circ}\text{C}$	2.360		2.640	V
ΔV_O	Line Regulation	$V_{in}=4.5$ to 22.5V		5	15	mV
ΔV_O	Load Regulation	$I_O=0$ to 50mA $I_O=0$ to 10mA		20 12	30	mV mV
I_s	Supply Current	$T_j=-55$ to 125 $^{\circ}\text{C}$		30	40	μA
ΔI_s	Supply Current Change	$I_O=0$ to 50mA $V_{in}=4.5$ to 22.5V		1 2	± 10 10	μA μA
V_n	Output Noise Voltage	f=10Hz to 10KHz		65		$\mu\text{V rms}$
$\Delta V_{in}/\Delta V_O$	Ripple Rejection	$V_{in}=6.3$ to 18V f=120Hz	55	75		dB
V_{in}	Input Voltage Required To Maintain Regulation		4.2	3.9		V
$\Delta V_O/\Delta T$	Average Temperature Coefficient of V_O	$I_O=5.0\text{mA}$ $T_j=-55$ to 125 $^{\circ}\text{C}$		0.275	0.700	mV/ $^{\circ}\text{C}$

ZMR SERIES

ZMR50H

ELECTRICAL CHARACTERISTICS

TEST CONDITIONS (Unless otherwise stated): $T_j=25^{\circ}\text{C}$, $I_O=10\text{mA}$, $V_{in}=10\text{V}$

SYMBOL	PARAMETER	CONDITIONS	MIN.	TYP.	MAX.	UNITS
V_O	Output Voltage		4.875	5	5.125	V
		$I_O=0$ to 50mA $T_j=-55$ to 125°C	4.780		5.160	V
		$V_{in}=7$ to 25V $I_O=0$ to 50mA $T_j=-55$ to 125°C	4.780		5.175	V
ΔV_O	Line Regulation	$V_{in}=7$ to 25V		5	15	mV
ΔV_O	Load Regulation	$I_O=0$ to 50mA $I_O=0$ to 10mA		25 15	40	mV mV
I_s	Supply Current	$T_j=-55$ to 125°C		50	70	μA
ΔI_s	Supply Current Change	$I_O=0$ to 50mA $V_{in}=7$ to 25V		1 2	± 10 10	μA μA
V_n	Output Noise Voltage	$f=10\text{Hz}$ to 10KHz		90		$\mu\text{V rms}$
$\Delta V_{in}/\Delta V_O$	Ripple Rejection	$V_{in}=8$ to 18V $f=120\text{Hz}$	55	72		dB
V_{in}	Input Voltage Required To Maintain Regulation		7	6.7		V
$\Delta V_O/\Delta T$	Average Temperature Coefficient of V_O	$I_O=5.0\text{mA}$ $T_j=-55$ to 125°C		0.275	0.700	$\text{mV}/^{\circ}\text{C}$

ZMR SERIES

ZMR250

ELECTRICAL CHARACTERISTICS

TEST CONDITIONS (Unless otherwise stated): $T_j=25^\circ\text{C}$, $I_O=10\text{mA}$, $V_{in}=6.5\text{V}$

SYMBOL	PARAMETER	CONDITIONS	MIN.	TYP.	MAX.	UNITS
V_O	Output Voltage		2.438	2.5	2.563	V
		$I_O=0$ to 50mA $T_j=-55$ to 125°C	2.360		2.640	V
		$V_{in}=4.5$ to 20V $I_O=0$ to 50mA $T_j=-55$ to 125°C	2.360		2.640	V
ΔV_O	Line Regulation	$V_{in}=4.5$ to 20V		5	15	mV
ΔV_O	Load Regulation	$I_O=0$ to 50mA		20	30	mV
		$I_O=0$ to 10mA		12		mV
I_s	Supply Current	$T_j=-55$ to 125°C		30	40	μA
ΔI_s	Supply Current Change	$I_O=0$ to 50mA		1	± 10	μA
		$V_{in}=4.5$ to 20V		2	10	μA
V_n	Output Noise Voltage	$f=10\text{Hz}$ to 10KHz		65		$\mu\text{V rms}$
$\Delta V_{in}/\Delta V_O$	Ripple Rejection	$V_{in}=6.3$ to 18V $f=120\text{Hz}$	55	75		dB
V_{in}	Input Voltage Required To Maintain Regulation		4.2	3.9		V
$\Delta V_O/\Delta T$	Average Temperature Coefficient of V_O	$I_O=5.0\text{mA}$ $T_j=-55$ to 125°C		0.275	0.700	$\text{mV}/^\circ\text{C}$

ZMR SERIES

ZMR500

ELECTRICAL CHARACTERISTICS

TEST CONDITIONS (Unless otherwise stated): $T_j=25^{\circ}\text{C}$, $I_O=10\text{mA}$, $V_{in}=10\text{V}$

SYMBOL	PARAMETER	CONDITIONS	MIN.	TYP.	MAX.	UNITS
V_O	Output Voltage		4.875	5	5.125	V
		$I_O=0$ to 50mA $T_j=-55$ to 125°C	4.780		5.160	V
		$V_{in}=7$ to 20V $I_O=0$ to 50mA $T_j=-55$ to 125°C	4.780		5.175	V
ΔV_O	Line Regulation	$V_{in}=7$ to 20V		5	15	mV
ΔV_O	Load Regulation	$I_O=0$ to 50mA $I_O=0$ to 10mA		25 15	40	mV mV
I_s	Supply Current	$T_j=-55$ to 125°C		50	70	μA
ΔI_s	Supply Current Change	$I_O=0$ to 50mA $V_{in}=7$ to 20V		1 2	± 10 10	μA μA
V_n	Output Noise Voltage	$f=10\text{Hz}$ to 10KHz		90		$\mu\text{V rms}$
$\Delta V_{in}/\Delta V_O$	Ripple Rejection	$V_{in}=8$ to 18V $f=120\text{Hz}$	55	72		dB
V_{in}	Input Voltage Required To Maintain Regulation		7	6.7		V
$\Delta V_O/\Delta T$	Average Temperature Coefficient of V_O	$I_O=5.0\text{mA}$ $T_j=-55$ to 125°C		0.275	0.700	$\text{mV}/^{\circ}\text{C}$

ZMR SERIES

TYPICAL CHARACTERISTICS

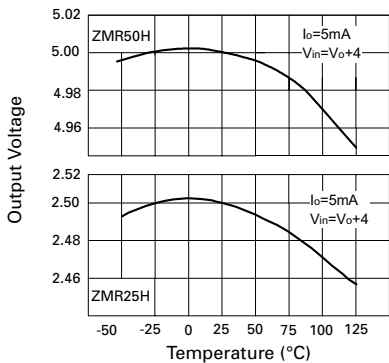

Output Voltage Temperature

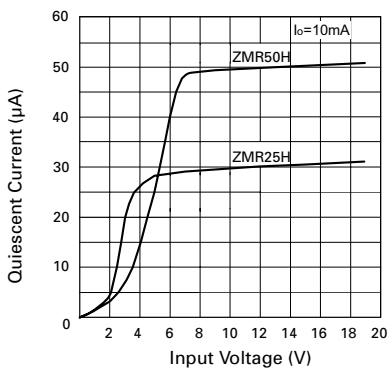

Quiescent Current v Voltage

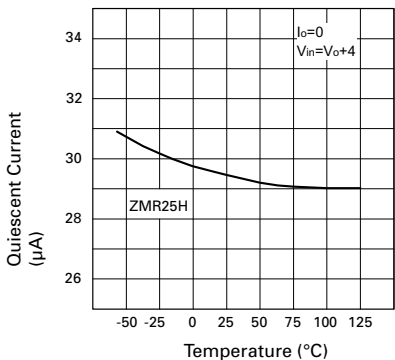

Quiescent Current v Temperature

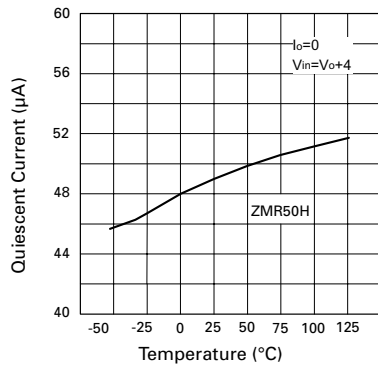

Quiescent Current v Temperature

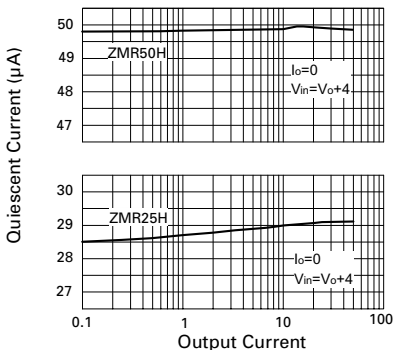

Quiescent Current v Output Current

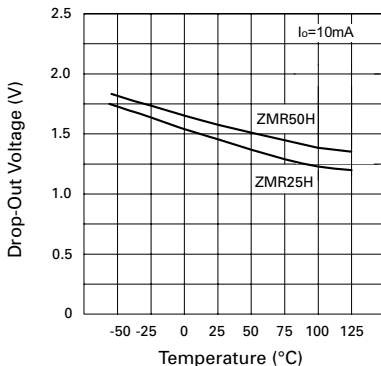

Drop-Out Voltage v Temperature

ZMR SERIES

TYPICAL CHARACTERISTICS

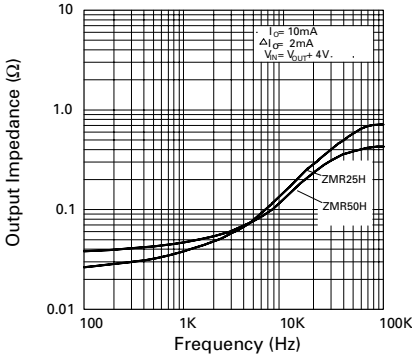

Output Impedance v Frequency

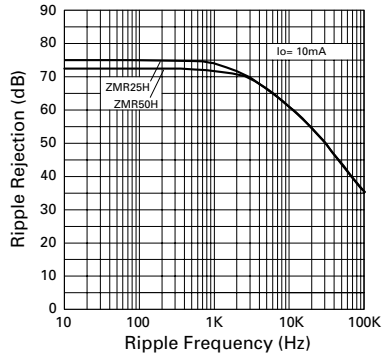

Ripple Rejection v Ripple Frequency

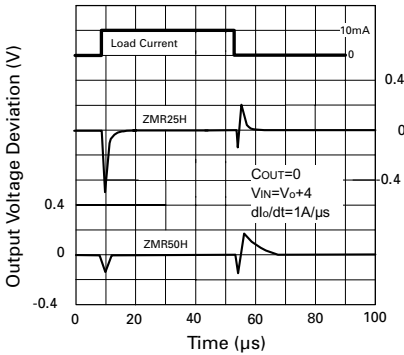

Load Transient Response

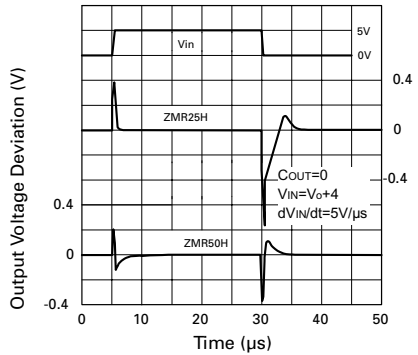

Line Transient Response

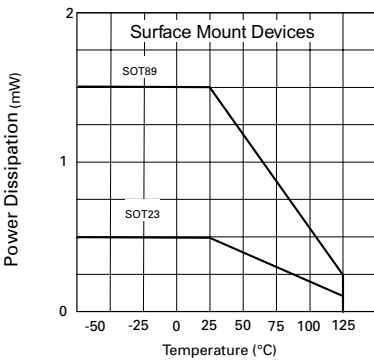

Power Derating

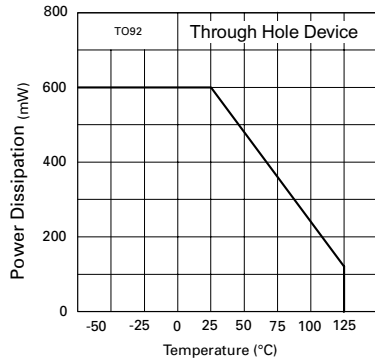

Power Derating

ZMR SERIES

TYPICAL CHARACTERISTICS

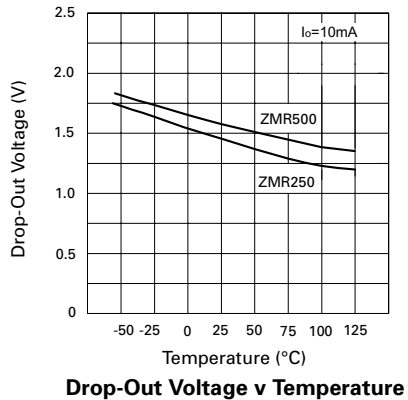
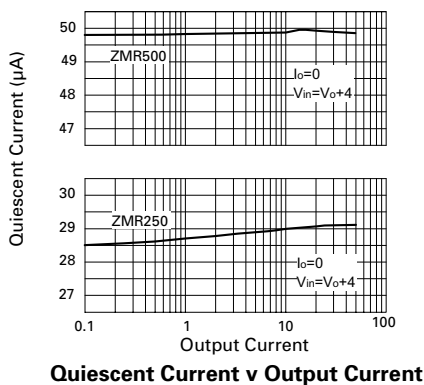
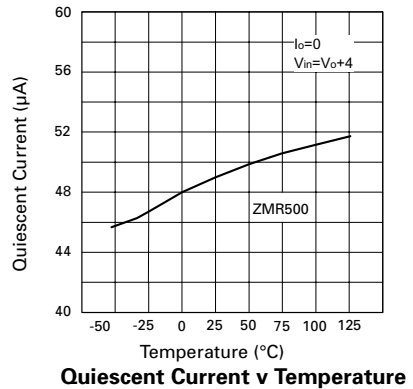
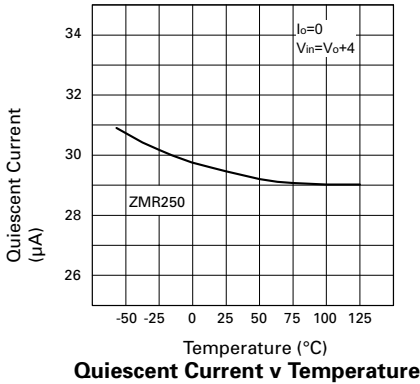
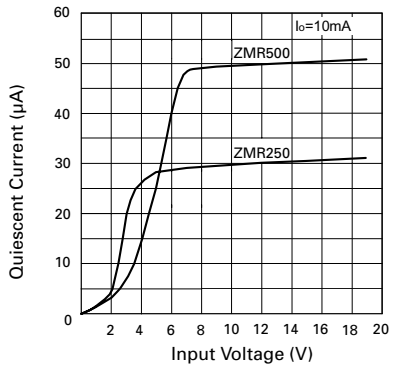
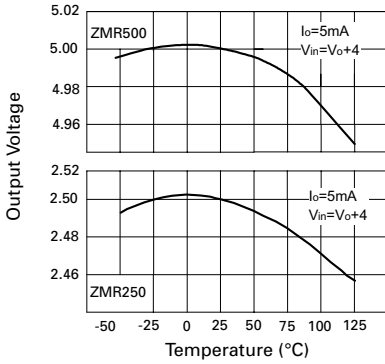

ZMR SERIES

TYPICAL CHARACTERISTICS

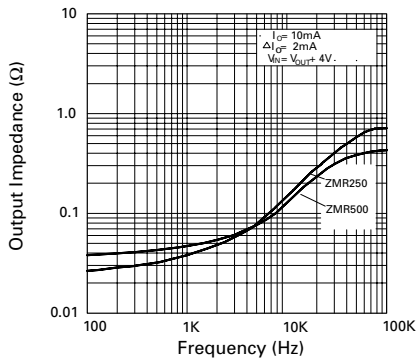

Output Impedance v Frequency

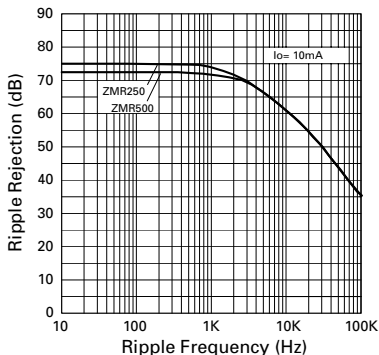

Ripple Rejection v Ripple Frequency

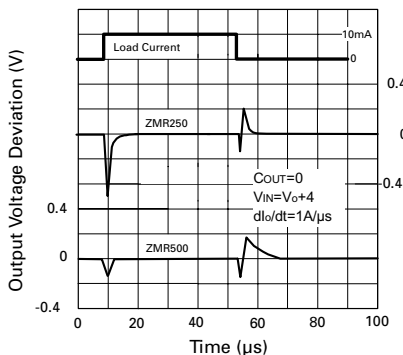

Load Transient Response

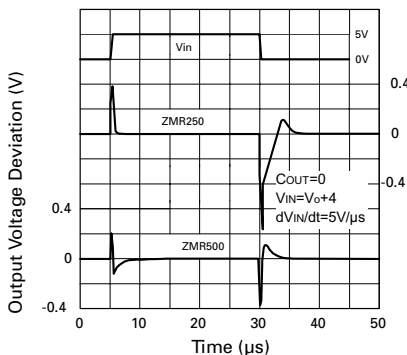

Line Transient Response

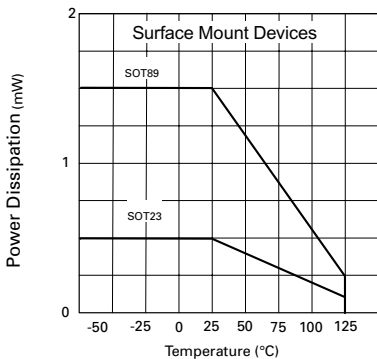

Power Derating

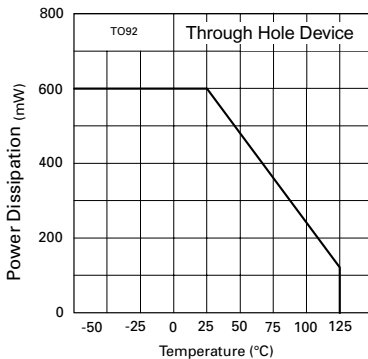

Power Derating

ZMR SERIES

CONNECTION DIAGRAMS

SOT23 Package Suffix - F

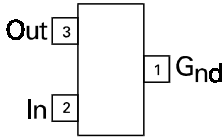

Top View

TO92 Package Suffix - C

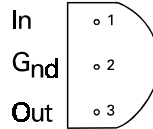

Bottom View

SOT89

Package Suffix - Z

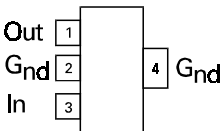

Top View

ORDERING INFORMATION

Part Number	Package	Part Mark
ZMR250C	TO92	ZMR250
ZMR250F	SOT23	25K
ZMR250Z	SOT89	25K
ZMR25HC	TO92	ZMR25H
ZMR25HF	SOT23	25X
ZMR25HZ	SOT89	25T
ZMR500C	TO92	ZMR500
ZMR500F	SOT23	50K
ZMR500Z	SOT89	50K
ZMR50HC	TO92	ZMR50H
ZMR50HF	SOT23	50R
ZMR50HZ	SOT89	50T