

The Combination of the Hyper LED and Shine-proof Achieves both Ease-of-use and High Performance

- Hyper LED mounted. Finest pin-point beam in the industry allows detection of minute objects.
- Shine-proof optical system achieves stable detection of objects regardless of glossiness, color, material, surface irregularities, or inclination.
4% or less black/white error: (E3G-L1),
4% or less differential travel: (E3G-L1)
- Simple teaching of background or surface of conveyor. Double-bar display indicates excess gain at a glance.
- A line-up of M8 connector which ensures easy maintenance.
- Meets IEC IP67 requirements, thus resisting water.



Ordering Information

■ Sensors

Red light Infrared light

Appearance	Connection method	Sensing/Setting range	Operating mode	Model	
				NPN output	PNP output
	Pre-wired		Light-ON Dark-ON (selectable)	E3G-L11	E3G-L12
	Connector			E3G-L15	E3G-L16
	Pre-wired			E3G-L31	E3G-L32
	Connector			E3G-L35	E3G-L36

■ Accessories (Order Separately)

Mounting Brackets

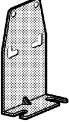
Shape	Model	Minimum order	Remarks
	E39-L139	1	Provided with E3G-Lj 1/-Lj 2
	E39-L140	1	Provided with E3G-Lj 5/-Lj 6

Sensor I/O Connectors

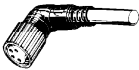
Item	Shape	Cable type		Remarks
Vibration-proof robot cable	Straight 	2 m	Four-wire type	XS3F-M421-402-R
		5 m		XS3F-M421-405-R
	L-shaped 	2 m		XS3F-M422-402-R
		5 m		XS3F-M422-405-R

Note: Refer to the *Sensor I/O Connectors Catalog (X065)* for details.

Specifications

■ Ratings/Characteristics

Model Item	Sensing method	Distance-setting			
	NPN output	E3G-L11	E3G-L15	E3G-L31	E3G-L35
	PNP output	E3G-L12	E3G-L16	E3G-L32	E3G-L36
Setting range		30 to 50 mm (white paper, black paper: 50 x 50 mm)		50 to 200 mm (white paper 50 x 50 mm) 50 to 150 mm (black paper 50 x 50 mm)	
Sensing range		5 to 50 mm (white paper 50 x 50 mm, setting distance 50 mm)		5 to 200 mm (white paper 50 x 50 mm, setting distance 200 mm) 5 to 150 mm (black paper 50 x 50 mm, setting distance 150 mm)	
Differential travel		4% max. of sensing distance		10% of sensing distance (typical)	
Reflectivity characteristics (black/white error)		4% max. of sensing distance		10% max. of sensing distance (at 50 to 150-mm setting distance)	
Light source (wavelength)		Red LED (670 nm)		Infrared LED (860 nm)	
Spot size		1 mm dia. max. (at 38-mm sensing distance)		15 mm dia. max. (at 150 mm sensing distance)	
Power supply voltage		10 to 30 VDC including 10% (p-p) ripple			
Current consumption		55 mA max.		65 mA max.	
Control output		Load power supply voltage: 30 VDC max. Load current 100 mA max. Residual voltage: NPN output: 1.2 V max. PNP output: 2.0 V max. Open collector output (NPN/PNP, differs depending on models) Light ON/Dark ON selectable			
Circuit protection		Protection from reversed power supply connection, load short-circuit, and mutual interference			
Response time		Operation or reset: 1.5 ms max.		Operation or reset: 2.5 ms max.	
Distance setting		Teaching (in NORMAL or ZONE mode)			
Fine distance adjustment		Manual fine threshold adjustment (NORMAL mode: 13 levels/ZONE mode: 5 levels)			
Indicator		Operation indicator (orange LED), distance indicator (green LED: 8 levels), threshold indicator (red LED, NORMAL mode: 13 levels/ZONE mode: 5 levels)			
Ambient illumination (receiver side)		Incandescent lamp: 3,000 lx max./Sunlight: 10,000 lx max.			
Ambient temperature		Operating: -25_C to 55_C/Storage: -30_C to 70_C (with no icing or condensation)			
Ambient humidity		Operating: 35% to 85%/Storage: 35% to 95% (with no condensation)			
Insulation resistance		20 MΩ min. at 500 VDC			
Dielectric strength		1,000 VAC 50/60Hz 1 min.			
Vibration resistance		Destruction: 10 to 55 Hz, 1.5 mm double amplitude for 2 hours each in X, Y, and Z direction			
Shock resistance		Destruction: 500m/s ² 3 times each in X, Y, and Z direction			
Degree of protection		IEC60529 IP67 (with protective cover)			
Connection method		Pre-wired (standard length: 2 m)	M8 connector	Pre-wired (standard length: 2 m)	M8 connector
Weight (packed state)		Approx. 64 g	Approx. 21 g	Approx. 64 g	Approx. 21 g
Material	Case	PBT (polybutylene terephthalate)			
	Lens	Acrylic (PMMA)			
	Mounting bracket	Stainless steel (SUS304)			
Accessories		Mounting bracket (with screws) and instruction sheet			

Operation

■ Output Circuits

Output configuration	NPN		PNP	
Model	E3G-L11 E3G-L15 E3G-L31 E3G-L35		E3G-L12 E3G-L16 E3G-L32 E3G-L36	
Output transistor status	Light ON	Dark ON	Light ON	Dark ON
Timing chart				
Mode selector	L/ON (Light ON)	D/ON (Dark ON)	L/ON (Light ON)	D/ON (Dark ON)
Output circuit	<p>Connector Pin Arrangement</p> <p>Pin 2 is open.</p>		<p>Connector Pin Arrangement</p> <p>Pin 2 is open.</p>	

■ Structure of Sensor I/O Connector

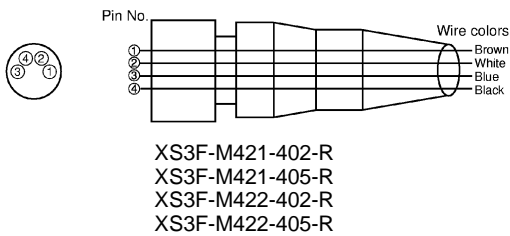

Classification	Wire color	Connector pin No.	Use
DC	Brown	1	Power supply (+ V)
	White	2	—
	Blue	3	Power supply (0 V)
	Black	4	Output

Note: 1. Pin 2 is not used.

2. For details, refer to the *Sensor I/O Connectors Catalog (X065)*.

Engineering Data (Typical)

Operating Range

E3G-L1j (in NORMAL Mode)

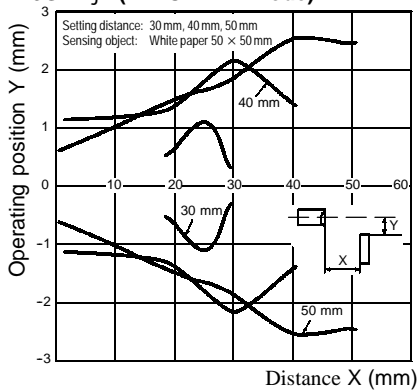

E3G-L1j (in ZONE Mode)

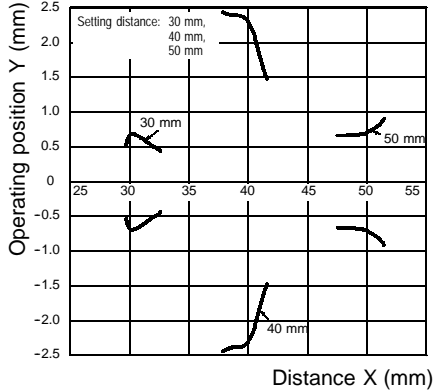

Spot Diameter vs. Sensing Distance

E3G-L1j

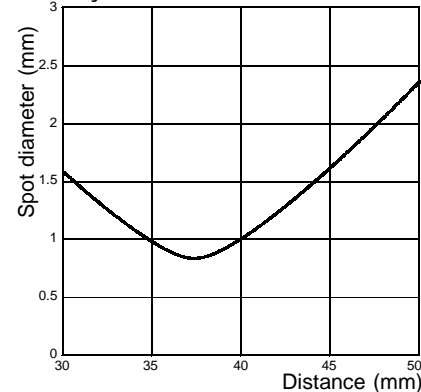

E3G-L3j (in NORMAL Mode)

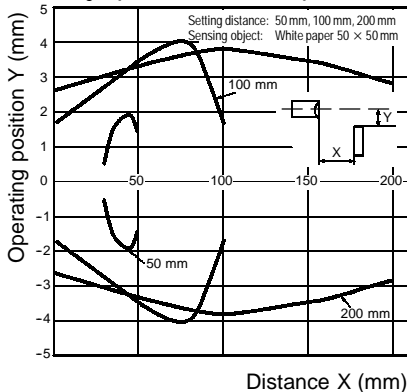

E3G-L3j (in ZONE Mode)

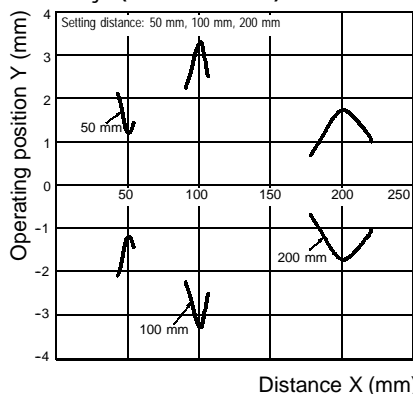

E3G-L3j

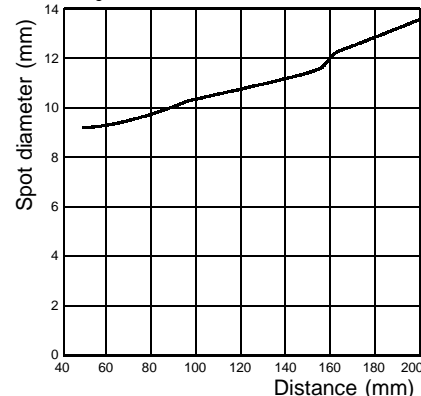

Angle Characteristics

E3G-L1j (Up and Down)

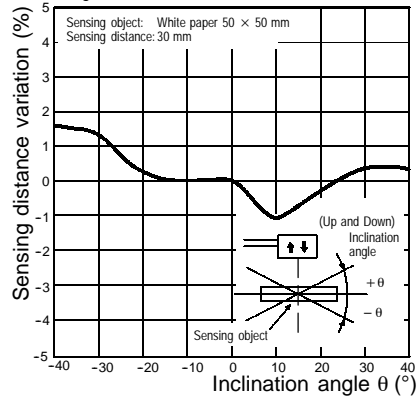

E3G-L1j (Left and Right)

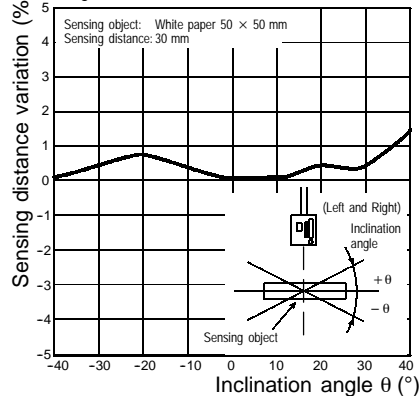

Sensing Object Size vs. Setting Distance

E3G-L1j

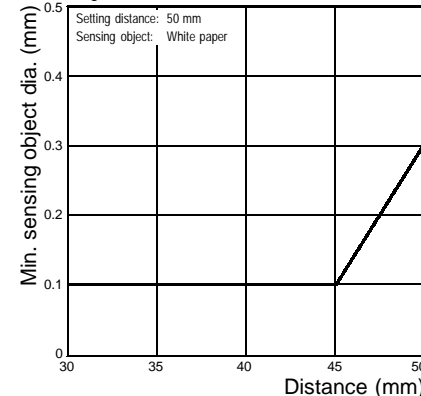

E3G-L1j (Up and Down)

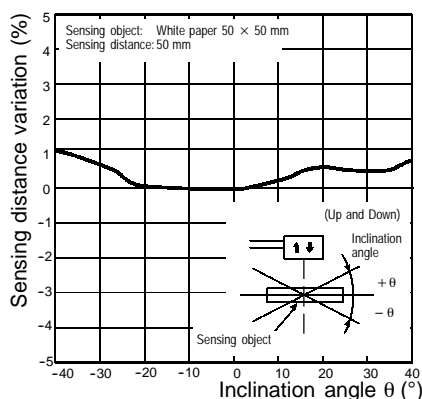

E3G-L1j (Left and Right)

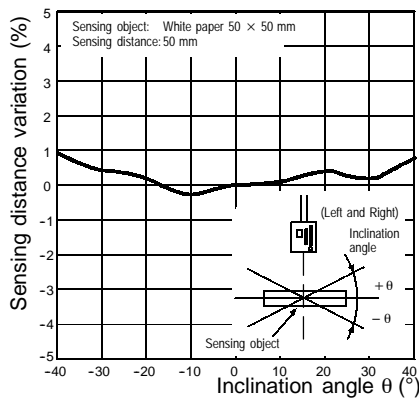

E3G-L3j

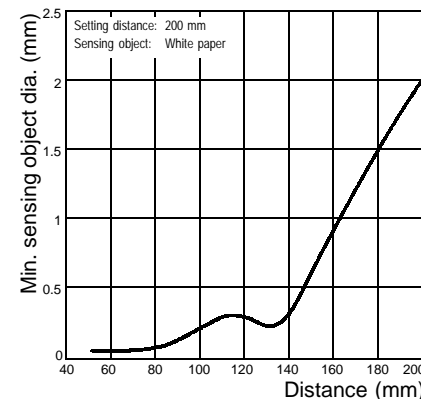

Angle Characteristics

E3G-L3j (Up and Down)

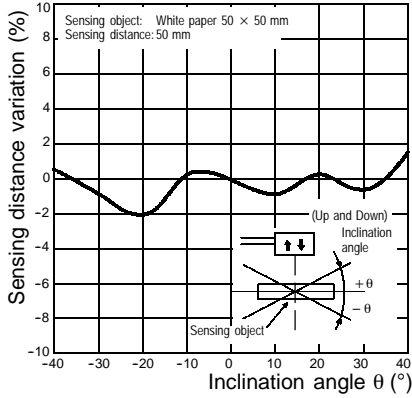

E3G-L3j (Left and Right)

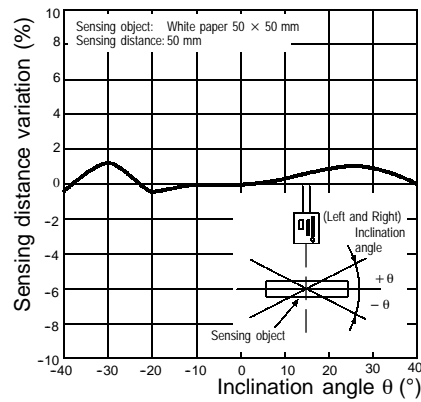

Close-range Characteristics

E3G-L1j

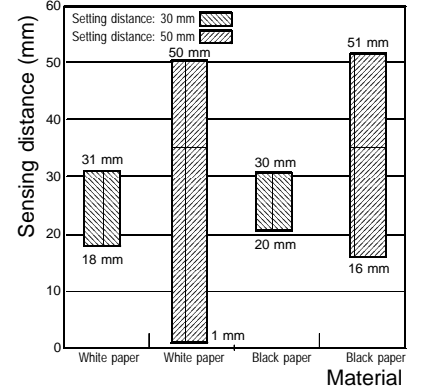

E3G-L3j (Up and Down)

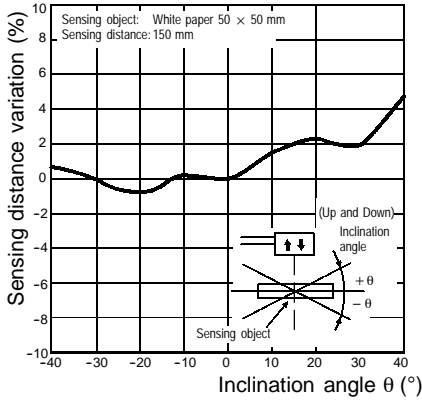

E3G-L3j (Left and Right)

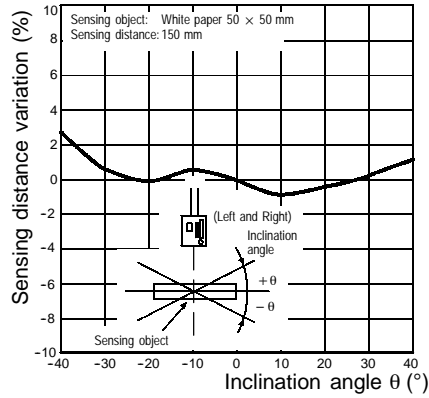

E3G-L3j

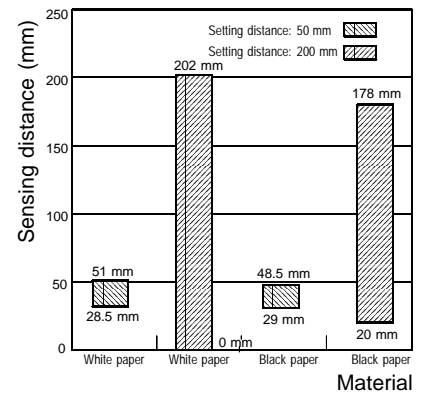

Sensing Distance vs. Sensing Object Material

E3G-L1V (at 30-mm Setting Distance)

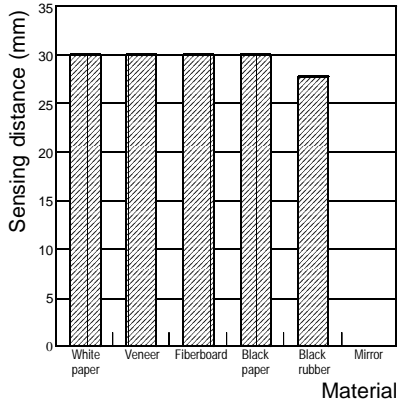

E3G-L1V (at 40-mm Setting Distance)

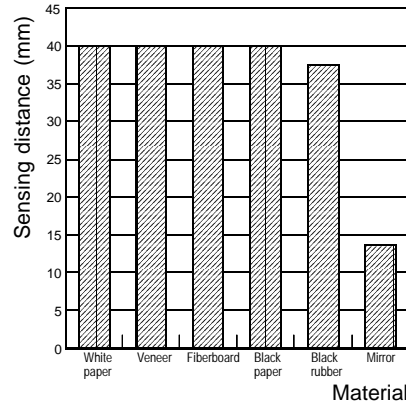

E3G-L1V (at 50-mm Setting Distance)

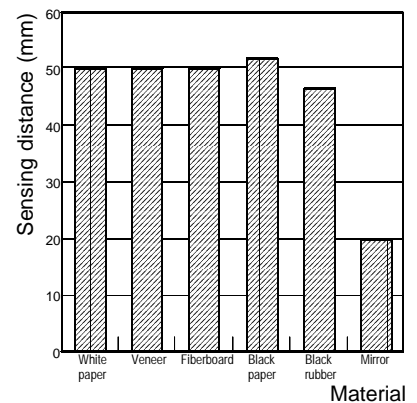

E3G-L3j (at 50-mm Setting Distance)

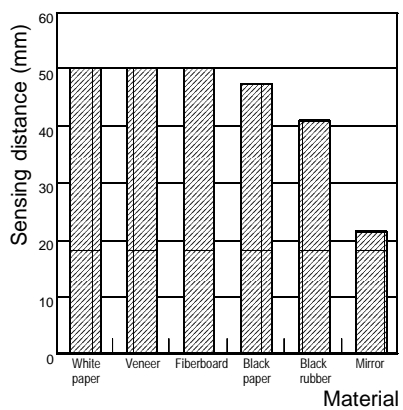

E3G-L3j (at 100-mm Setting Distance)

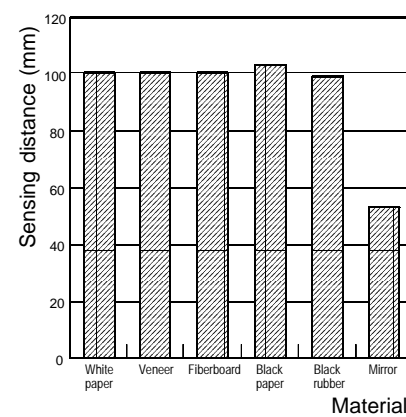

E3G-L3j (at 150-mm Setting Distance)

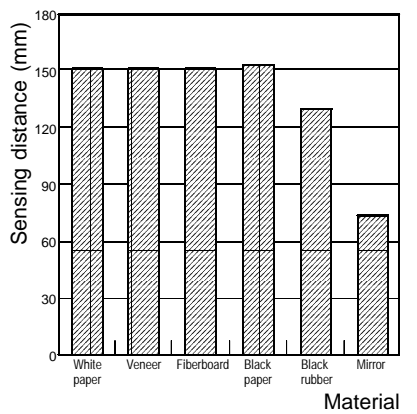

Nomenclature

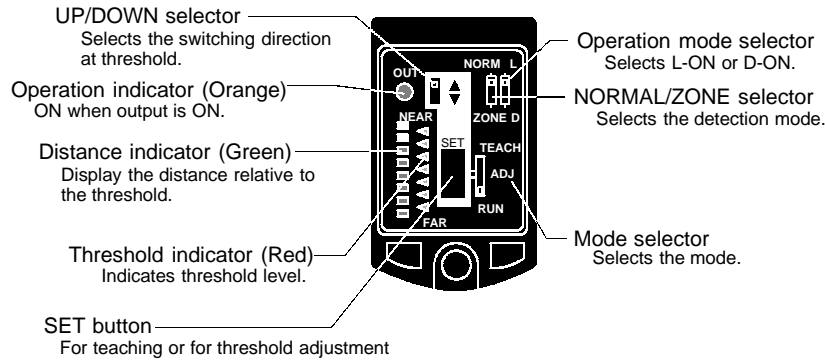

Installation

Designing

Do not pull cables with tensile strength exceeding 50 N for the cable pull-out or connector types.

High-tension Lines

Do not wire power lines or high-tension lines alongside the lines of the Sensor in the same conduit, otherwise the Sensor may be damaged or may malfunction due to induction. Be sure to wire the lines of the Sensor separated from power lines or high-tension lines or laid in an exclusive, shielded conduit.

Turning the Power ON

The Sensor needs 100 ms to be ready to operate after it is turned ON. The devices connected to the Photoelectric Sensor must wait until the Sensor is ready to operate. If the Sensor and load are connected to separate power supplies, be sure to turn ON the Sensor first.

Power Supply

If a standard switching regulator is used, be sure to ground the FG (frame ground) and G (ground) terminals, otherwise the Sensor may malfunction due to the switching noise of the regulator.

Wiring

Cable

- The bending radius of the cable should be 25 mm min.
- In a case where the cable is extended, use a wire with 0.3 mm² min. The total length of the cable should be 100 m max.

Avoiding Malfunctions

If using the photoelectric sensor with an inverter or servomotor, be sure to ground the FG (frame ground) and G (ground) terminals, otherwise the Sensor may malfunction.

Mounting

Mounting Conditions

- If Sensors are mounted face-to-face, make sure that no optical axes cross each other. Otherwise, mutual interference may result.
- Be sure to install the Sensor carefully so that the directional angle range of the Sensor will not be directly exposed to intensive light, such as sunlight, fluorescent light, or incandescent light.
- Do not strike the Photoelectric Sensor with a hammer or any other tool during the installation of the Sensor, or the Sensor will lose its water-resistive properties.
- Use M3 screws to mount the Sensor.
- When mounting the case, make sure that the tightening torque applied to each screw does not exceed 0.54 N·m.

M8 Connector

- Be sure to connect or disconnect the M8 connector after turning OFF the Sensor.
- Be sure to hold the connector cover when connecting or disconnecting the M8 connector.
- Secure the M8 connector by hand. Do not use any pliers, otherwise the connector may be damaged.
- If the M8 connector is not connected securely, the M8 connector may be disconnected by vibration or the proper degree of protection of the Sensor may not be maintained.

Mounting Directions

Make sure that the sensing side of the Sensor is parallel with the surface of each sensing object. Do not incline the Sensor towards the sensing object.

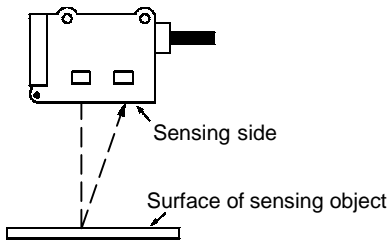

If the sensing object has a glossy surface, incline the Sensor by 5° to 10° as shown below, provided that the Sensor is not influenced by any background objects.

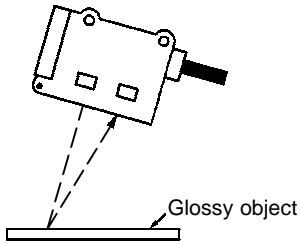

If there is a mirror-like object below the Sensor, the Sensor may not be in stable operation. Therefore, incline the Sensor or keep the Sensor a distance away from the mirror-like object as shown below.

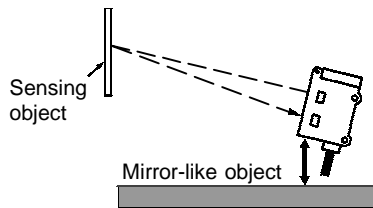

Make sure not to install the Sensor in the incorrect direction. Refer to the following.

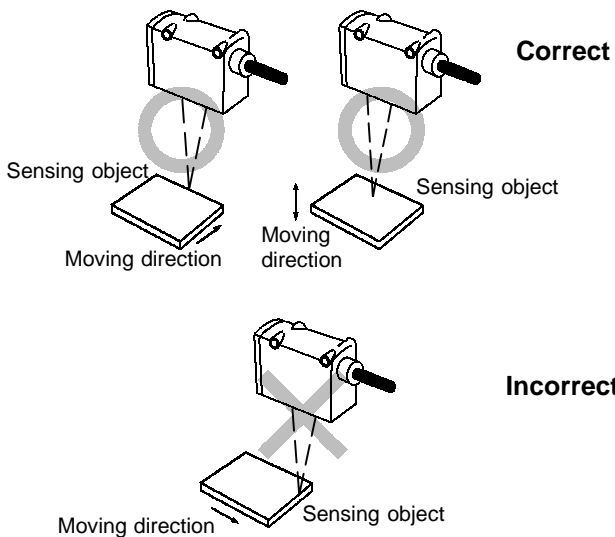

Install the Sensor as shown in the following if each sensing object greatly differs in color or material.

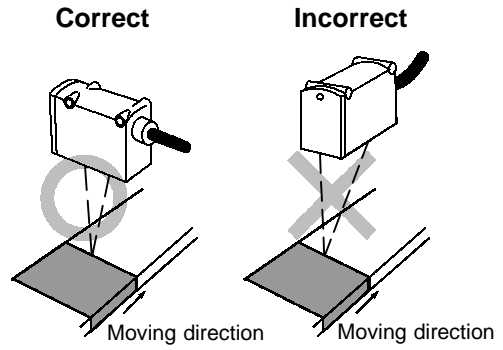

Adjustments

If the Sensor is not in stable operation due to color differences, make a fine adjustment of the threshold level and confirm that the Sensor operates in stable state.

Refer to *Manual Teaching (Fine Distance Setting)* Page 12

Adjustments

Adjustment Steps

1	Install, wire, and turn on the Sensor.
2	Perform distance setting (teaching). Refer to <i>Distance Setting (Teaching)</i> below.
3	Make a fine adjustment of the threshold, if necessary. Refer to <i>Manual Teaching (Fine Distance Setting)</i> . → Page 12
4	Check that the mode selector is set to RUN.

Distance Setting (Teaching)

Select the most appropriate teaching method in reference to the following descriptions.

Application	1	2	3
	Teaching without sensing objects (i.e., Teaching the background).	<ul style="list-style-type: none"> Detection of slight differences in surface level. Setting a threshold in the middle between the background and sensing object for operation. 	<ul style="list-style-type: none"> Detection of glossy objects in front of the background.

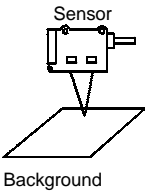
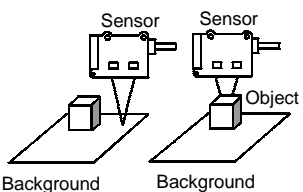
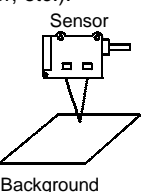
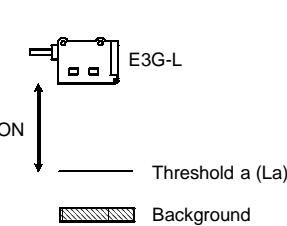
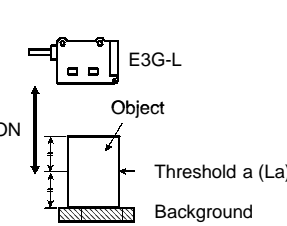
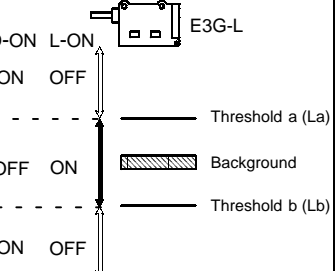
Teaching	1	2	3
Setting method	Normal one-point teaching Press the TEACH button with the background object. 	Normal two-point teaching Press the TEACH button with the background object and with the sensing object. 	Zone one-point teaching Press the TEACH button with the background object (conveyor, etc.). 
Set threshold	Threshold (a) is set immediately in front of the background.	Threshold (a) is set approximately in the middle between the background and sensing object.	A pair of thresholds, (a) and (b), are set.
Output ON range	The output is ON between the Sensor and La. 	The output is ON between the Sensor and La. 	The output is ON between La and Lb. 

La: Distance equivalent to threshold (a)

Lb: Distance equivalent to threshold (b)

- The following settings are also possible:
 - Setting the maximum sensing distance of the Sensor.: Maximum distance setting.
 - Setting the minimum differential travel of the Sensor.: Minimum distance setting.
- Distance from sensor to background must not exceed the values shown below during normal one-point or zone one-point teaching.

Model	Distance from sensor to background
E3G-L1j	32 mm min.
E3G-L3j	55 mm min.

- Maximum sensing distance of E3G-L3 type may differ by color of the sensing object when setting distance is more than 150 mm. Confirm the operation of the Sensor before actual operation.

Adjustments

1. Normal One-point Teaching

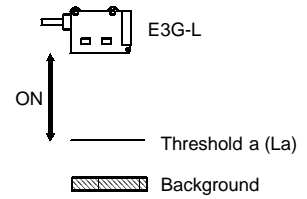
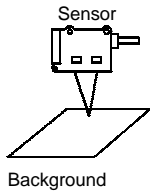

Procedure	Operation	Panel Status
1	Set the mode selector to TEACH.	<p>Threshold indicator (red) turns ON.</p>
2	Set the NORMAL/ZONE mode selector to NORMAL.	
3	Press the SET button with the background. The threshold indicator (red) will turn ON.	
4	Set the mode selector to RUN.	
5	Set to L-ON or D-ON mode with the operation mode selector. L-ON: Output ON between background and sensor. D-ON: Output OFF between background and sensor.	
Application Example 1 Adjusting the Sensor differential travel to the minimum distance.		<p>Threshold indicator (red) turns ON.</p> <p>Distance Indicator (green) turns ON.</p>
1	Set the mode selector to TEACH.	
2	Set the NORMAL/ZONE mode selector to NORMAL.	
3	Set the UP/DOWN selector to down.	
4	Press the SET button for 3 s or more. The threshold indicator (red) will turn ON.	
5	The distance indicator (green) will turn ON. This means that teaching is successful. Set the mode selector to RUN to complete the teaching operation.	
6	Set to L-ON or D-ON mode with the operation mode selector. (Refer to <i>Normal One-point Teaching</i>)	
Application Example 2 Setting the Sensor to the maximum distance.		<p>Threshold indicator (red) turns ON.</p> <p>Distance Indicator (green) turns ON.</p>
1	Set the mode selector to TEACH.	
2	Set the NORMAL/ZONE mode selector to NORMAL.	
3	Set the UP/DOWN selector to up.	
4	Press the SET button for 3 s or more. The threshold indicator (red) will turn ON.	
5	The distance indicator (green) will turn ON. This means that teaching is successful. Set the mode selector to RUN to complete the teaching operation.	
6	Set to L-ON or D-ON mode with the operation mode selector. (Refer to <i>Normal One-point Teaching</i>)	

La: Distance equivalent to threshold (a)

2. Normal Two-point Teaching

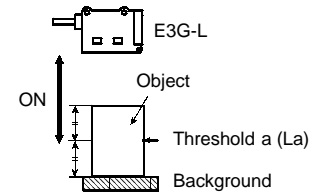
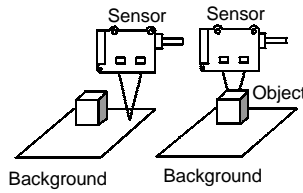

Procedure	Operation	Panel Status
1	Set the mode selector to TEACH.	
2	Set the NORMAL/ZONE mode selector to NORMAL.	
3	Press the SET button with a sensing object located at sensing position. The threshold indicator (red) will turn ON.	
4	Move the sensing object and press the SET button with the background. If the teaching is successful, the distance indicator (green) will turn ON. If the teaching is not successful, the threshold indicator (red) will start to flash.	
5	If the teaching is successful, set the mode selector to RUN to complete the teaching operation. If the teaching is not successful, change the position of the object and setting distance that have been set and repeat from the above step 3.	
6	Set to L-ON or D-ON mode with the operation mode selector.	

La: Distance equivalent to threshold (a)

3. Zone One-point Teaching

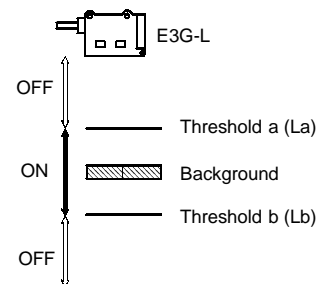
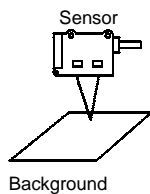

Procedure	Operation	Panel Status
1	Set the mode selector to TEACH.	
2	Set the NORMAL/ZONE mode selector to ZONE.	
3	Press the SET button with the background. All threshold indicators (Red) will turn ON while the SET button is pressed. When the SET button is released: • If the teaching is successful, the distance indicator (green) will turn ON. • If the teaching is not successful, the threshold indicator (red) will start to flash.	
4	Set the mode selector to RUN.	
5	Set to L-ON or D-ON mode with the operation mode selector. L-ON: Output ON with the background. D-ON: Output OFF with the background.	

La: Distance equivalent to threshold (a)

Adjustments

Manual Teaching (Fine Distance Setting)

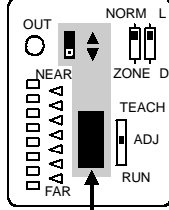
Procedure	Operation	Panel Status																																																																
<p>Fine adjustment of the threshold is possible after teaching.</p>																																																																		
1	Set the mode selector to ADJ.	 <p>SET pressed with UP/DOWN selector set to UP. Threshold increases.</p> <p>SET pressed with UP/DOWN selector set to DOWN. Threshold decreases.</p>																																																																
2	Set the adjustment direction in the ADJ mode with the UP/DOWN selector. The threshold changes each time the SET button is pressed. The setting can be made in up to 13 levels (for normal one-point or two-point teaching).	<p>Threshold Indicator Display During Distance Adjustment</p> <p>Max. 13 adjustment levels for normal teaching.</p> <table border="1" data-bbox="922 667 1385 875"> <tr> <td>▲▲▲▲</td><td>▲▲▲▲</td><td>▲▲▲▲</td><td>▲▲▲▲</td><td>▲▲▲▲</td><td>▲▲▲▲</td><td>▲▲▲▲</td><td>▲▲▲▲</td><td>▲▲▲▲</td><td>▲▲▲▲</td><td>▲▲▲▲</td><td>▲▲▲▲</td><td>▲▲▲▲</td> </tr> <tr> <td>▲▲▲▲</td><td>▲▲▲▲</td><td>▲▲▲▲</td><td>▲▲▲▲</td><td>▲▲▲▲</td><td>▲▲▲▲</td><td>▲▲▲▲</td><td>▲▲▲▲</td><td>▲▲▲▲</td><td>▲▲▲▲</td><td>▲▲▲▲</td><td>▲▲▲▲</td><td>▲▲▲▲</td> </tr> <tr> <td>1</td><td>2</td><td>3</td><td>4</td><td>5</td><td>6</td><td>7</td><td>8</td><td>9</td><td>10</td><td>11</td><td>12</td><td>13</td> </tr> </table> <p>Five adjustment levels for zone teaching.</p> <table border="1" data-bbox="922 920 1107 1122"> <tr> <td>▲▲</td><td>▲▲</td><td>▲▲</td><td>▲▲</td><td>▲▲</td> </tr> <tr> <td>▲▲</td><td>▲▲</td><td>▲▲</td><td>▲▲</td><td>▲▲</td> </tr> <tr> <td>▲▲</td><td>▲▲</td><td>▲▲</td><td>▲▲</td><td>▲▲</td> </tr> <tr> <td>▲▲</td><td>▲▲</td><td>▲▲</td><td>▲▲</td><td>▲▲</td> </tr> <tr> <td>1</td><td>2</td><td>3</td><td>4</td><td>5</td> </tr> </table>	▲▲▲▲	▲▲▲▲	▲▲▲▲	▲▲▲▲	▲▲▲▲	▲▲▲▲	▲▲▲▲	▲▲▲▲	▲▲▲▲	▲▲▲▲	▲▲▲▲	▲▲▲▲	▲▲▲▲	▲▲▲▲	▲▲▲▲	▲▲▲▲	▲▲▲▲	▲▲▲▲	▲▲▲▲	▲▲▲▲	▲▲▲▲	▲▲▲▲	▲▲▲▲	▲▲▲▲	▲▲▲▲	▲▲▲▲	1	2	3	4	5	6	7	8	9	10	11	12	13	▲▲	▲▲	▲▲	▲▲	▲▲	▲▲	▲▲	▲▲	▲▲	▲▲	▲▲	▲▲	▲▲	▲▲	▲▲	▲▲	▲▲	▲▲	▲▲	▲▲	1	2	3	4	5
▲▲▲▲	▲▲▲▲	▲▲▲▲	▲▲▲▲	▲▲▲▲	▲▲▲▲	▲▲▲▲	▲▲▲▲	▲▲▲▲	▲▲▲▲	▲▲▲▲	▲▲▲▲	▲▲▲▲																																																						
▲▲▲▲	▲▲▲▲	▲▲▲▲	▲▲▲▲	▲▲▲▲	▲▲▲▲	▲▲▲▲	▲▲▲▲	▲▲▲▲	▲▲▲▲	▲▲▲▲	▲▲▲▲	▲▲▲▲																																																						
1	2	3	4	5	6	7	8	9	10	11	12	13																																																						
▲▲	▲▲	▲▲	▲▲	▲▲																																																														
▲▲	▲▲	▲▲	▲▲	▲▲																																																														
▲▲	▲▲	▲▲	▲▲	▲▲																																																														
▲▲	▲▲	▲▲	▲▲	▲▲																																																														
1	2	3	4	5																																																														
3	After the adjustment is complete, set the mode selector to RUN.																																																																	

Threshold and Distance Indicator Displays

Display for distance setting with normal one-point or two-point teaching

The distance indicators show the distance level. The distance indicators show distances relative to the threshold. The threshold can be shifted using the UP/DOWN selector and SET button. The differential travel is fixed.

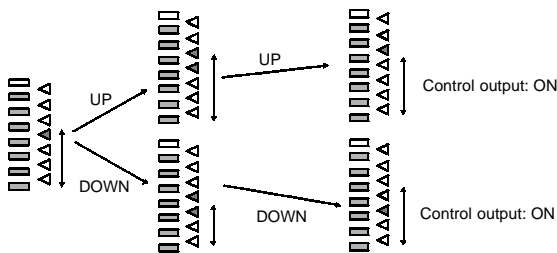

Display for distance setting with zone teaching

The distance indicators show the current distance band. The distance indicators show distances relative to the threshold. The ON range can be shifted using the UP/DOWN selector and SET button. The differential travel is fixed.

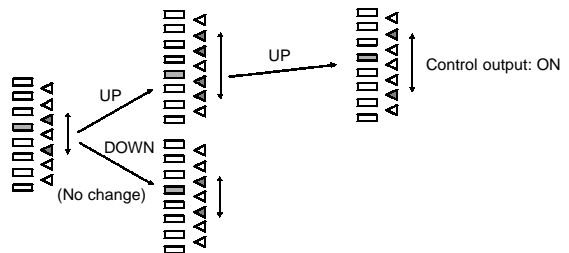

Maintenance and Inspection

Cleaning

- Paint thinner damages the casing of the Sensor. Do not apply paint thinner to clean the Sensor.

Others

Operating Environment

Do not install the Sensor in the following locations, otherwise the Sensor may malfunction.

- Places with excessive dust.
- Places with corrosive gases.
- Locations directly exposed to sprays of water, oil, or chemicals.

- Locations where the product is directly exposed to vibration or shock.

E2P-ROM Writing Error

- If a teaching data error occurs with the operation indicator flashing due to a power failure or static noise, perform the teaching operation of the Sensor again.

Water Resistivity

- Although conforming to IP67, do not use the Sensor in water, in the rain, or outdoors.
- To ensure the water resistivity of the Sensor, tighten the screws of the operation panel cover to a torque of 0.2 to 0.3 N·m.

Dimensions

Note: All units are in millimeters unless otherwise indicated.

■ Sensors

Pre-wired Models

E3G-L11/L31
E3G-L12/L32

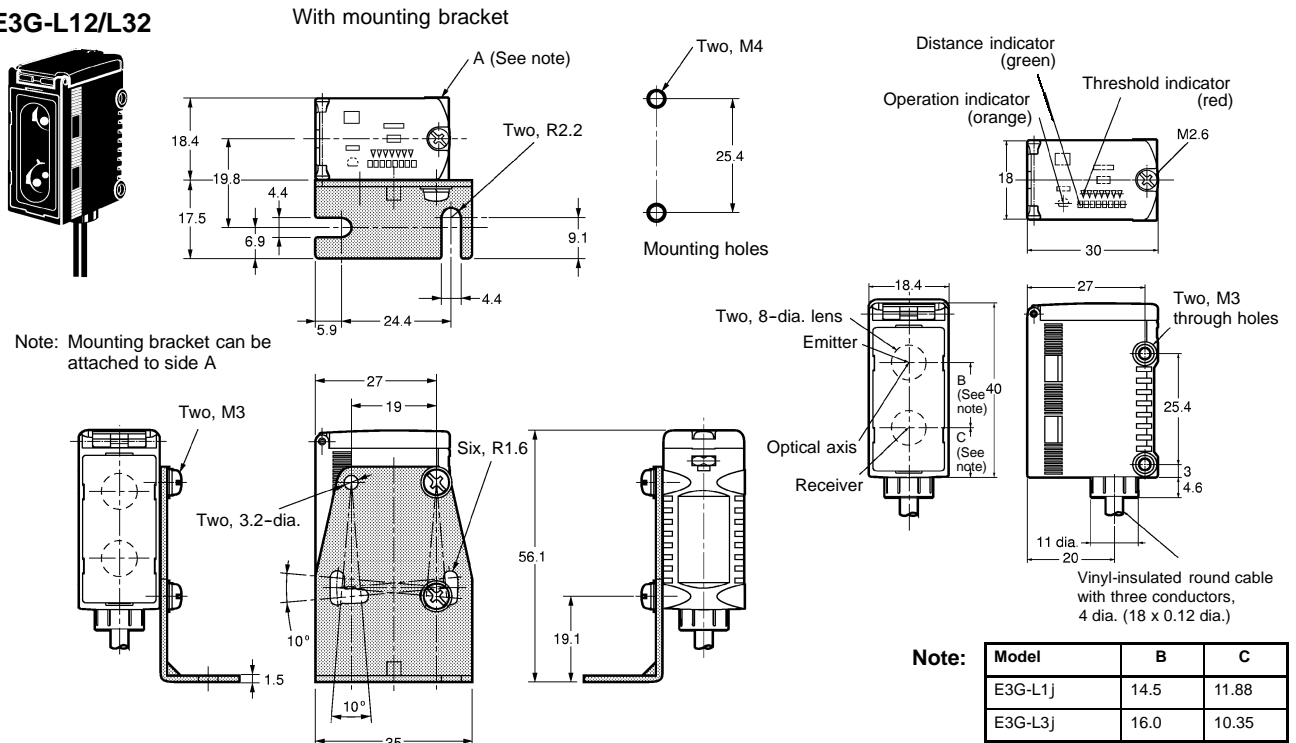

Connector Models

E3G-L15/L35
E3G-L16/L36

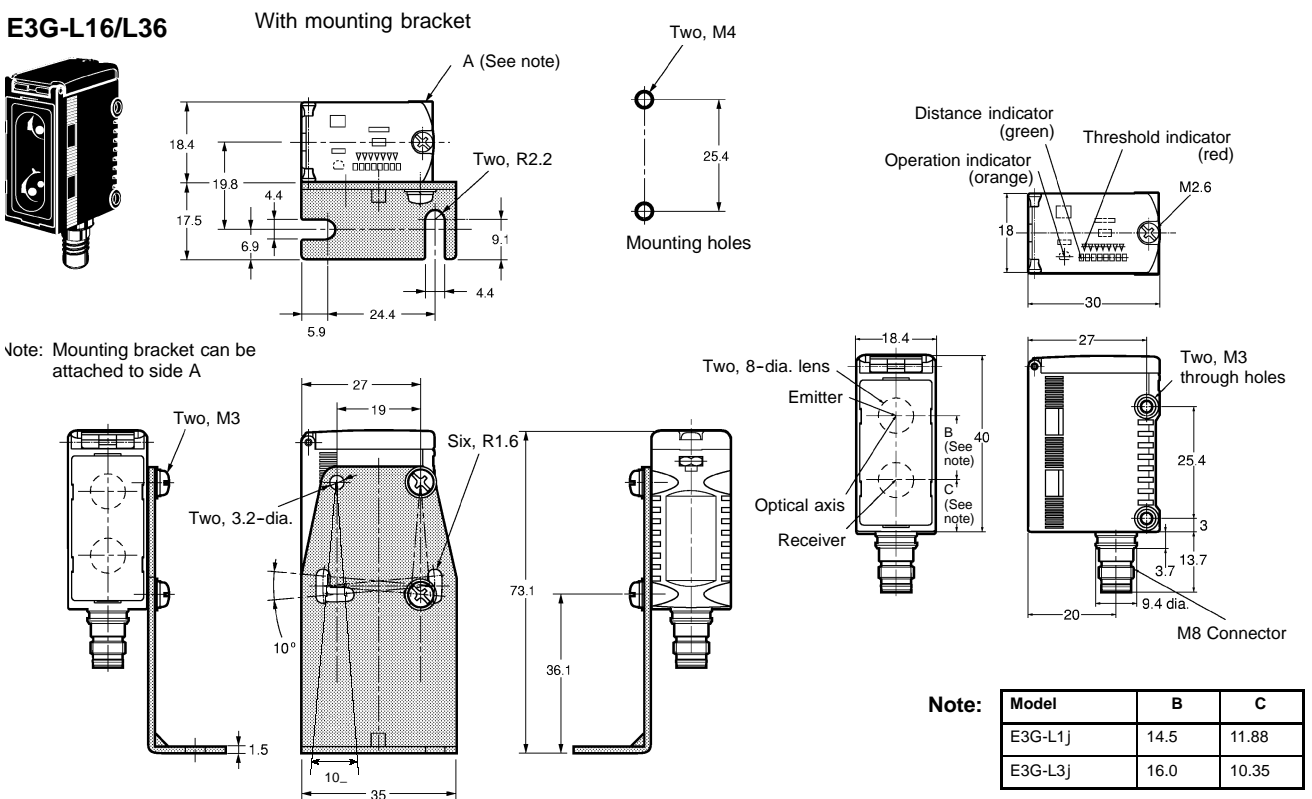

■ Accessories (Order Separately)

Mounting Brackets

E39-L139

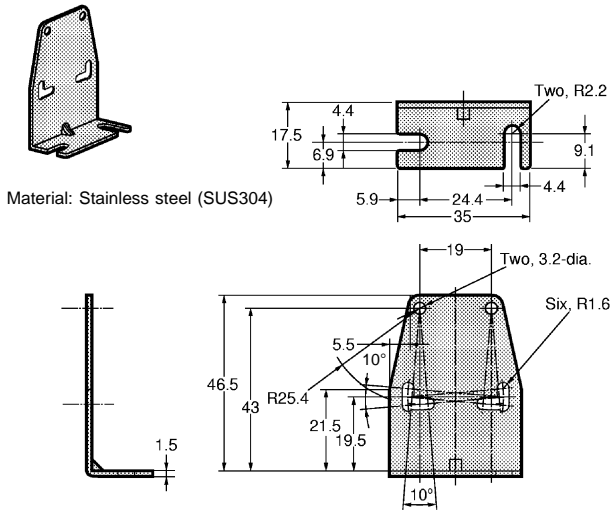

Note: Provided with E3G-Lj 1/-Lj 2

E39-L140

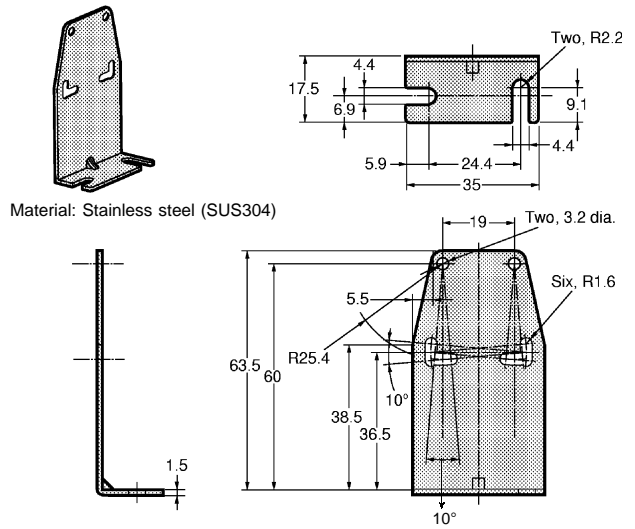

Note: Provided with E3G-Lj 5/-Lj 6

Sensor I/O Connectors

Vibration-proof Robot Cable
Straight

XS3F-M421-402-R (L = 2 m)

XS3F-M421-405-R (L = 5 m)

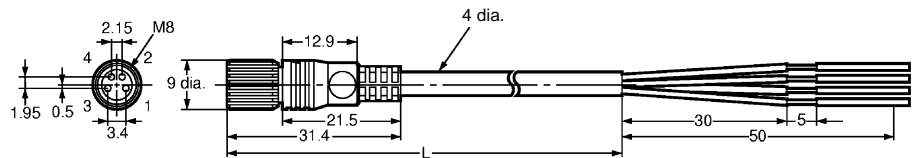

L-shaped

XS3F-M422-402-R (L = 2 m)

XS3F-M422-405-R (L = 5 m)

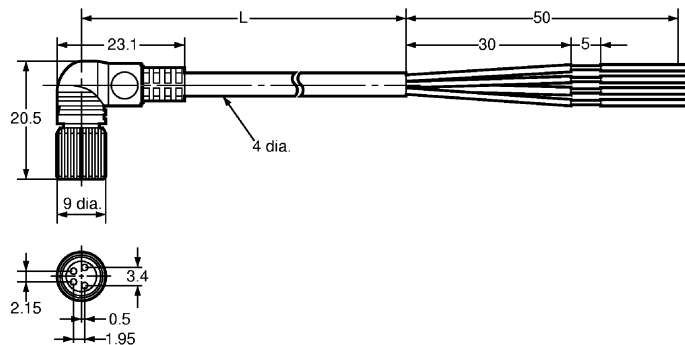
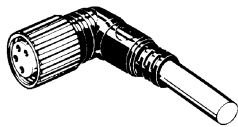

Precautions

Be sure to heed the following precautions to fully utilize the capabilities of the Sensor.

General

- Do not impose any voltage exceeding the rated voltage on the Sensor. Do not impose 100 VAC or more on models that operate with DC. In both cases, the Sensor may be damaged.
- Do not short-circuit the load connected to the Sensor, otherwise the Sensor may be damaged.
- The load must be connected to the Sensor in operation, otherwise the Sensor may be damaged.
- When supplying power to the Sensor, make sure that the polarity of the power is correct, otherwise the Sensor may be damaged.
- Do not use the Sensor under the environment with explosive or ignition gas.

ALL DIMENSIONS SHOWN ARE IN MILLIMETERS.

To convert millimeters into inches, multiply by 0.03937. To convert grams into ounces, multiply by 0.03527.

Cat. No. E900-E1-2 **In the interest of product improvement, specifications are subject to change without notice.**

OMRON Corporation

Industrial Sensors Division
Sensing Devices and Components Division H.Q.
28th Fl., Crystal Tower Bldg.,
1-2-27, Shiromi, Chuo-ku,
Osaka 540-6028 Japan
Phone: (81)6-6949-6012 Fax: (81)6-6949-6021

Printed in Japan
0199-3M (0199) 