

BERNSTEIN

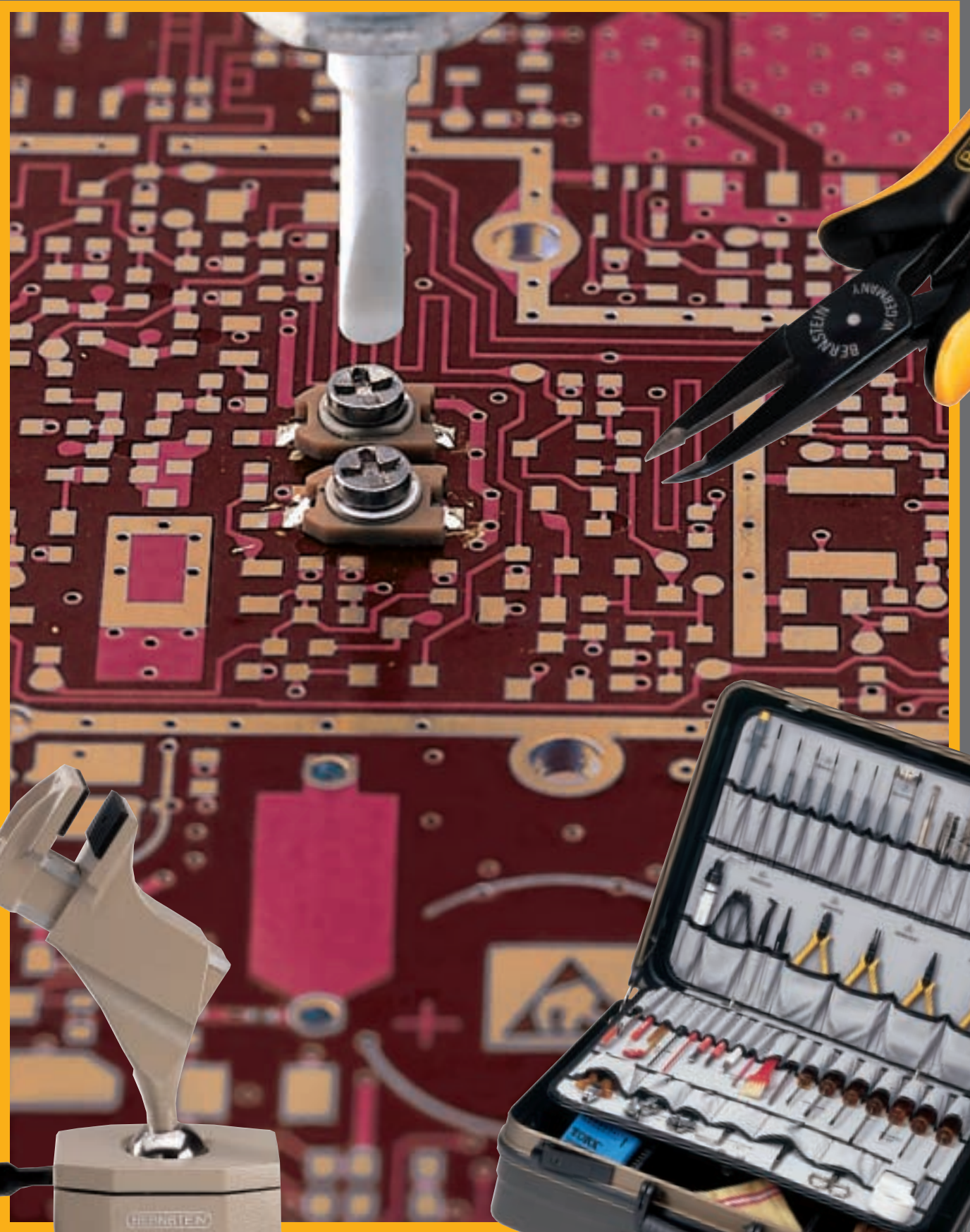

Electronic-Tools



INDEX

SERVICE CASES, SERVICE SETS

page 3 - 41



ADJUSTING AND SPECIAL TOOLS, DEMAGNETIZING THROTTLES

page 43 - 57



PLIERS

page 59 - 83



SCREWDRIVERS

page 85 - 95

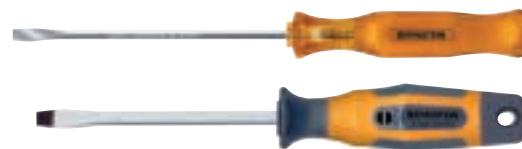

TWEEZERS, FILES, SCISSORS, KNIVES, STRIPPING TOOLS

page 97 - 107



WRENCHES, SOCKET WRENCHES, WRENCH KEYS, SPECIAL WRENCHES, TORX-SCREWDRIVERS, HAND-TOOLS, MEASURING TOOLS

page 109 - 119

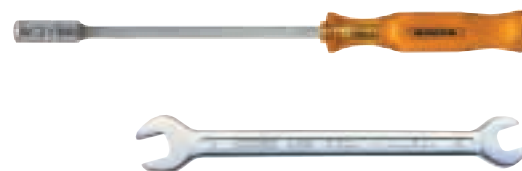

WORKSHOP EQUIPMENT, SPANNFIX VICES, ANTISTATIC COVERINGS AND ACCESSORIES, CONTROL MIRRORS, MAGNIFYING LAMPS, OFFICE LAMPS, SOLDERING AND DESOLDERING EQUIPMENT

page 121 - 137





TOP 1000 ELECTRONIC SERVICE CASE

The small attractive service case with special design



1000 **BERNSTEIN** TOP with tool set

1015 **BERNSTEIN** TOP without tool set

Description:

The BERNSTEIN TOP is an elegant, handsomely styled black case made from deep-drawn, impact-resistant plastic shells with inside pad and steel stiffened frame, closed by a nylon zipper with bidirectional sliders. It has loops at the sides for attaching a shoulder strap.

26 precision tools are clearly arranged on a swivel-tool-tray. The bottom contains a deep-drawn tray which provides five different partitions, 30 mm deep, for spare parts, also for a plastic box for components. When removing this tray, it is possible to place a notebook in the bottom.

The inside cover is provided with pockets for documents, 3.5" disks, pencils etc.

Outside dimensions: 400 x 320 x 90 mm

Weight without tools: approx. 2.000 kg

Weight with tools: approx. 2.700 kg

Tool set:

No. Description of individual tools

1-552	Adjusting screwdriver , 120 x 2 mm
2-126	Desoldering lever , with plastic handle, slotted at one end
2-127	Tin knife , with plastic handle, 115 mm
2-155	Claw-type gripper , nickel-plated brass, with 4 wire claws, small version with clip
2-166	Glass fibre contact cleaner
2-265	2 Test prods , red and black, extremely slim, pointed and flexible, blade made from 1 mm steel wire
2-275	Repair mirror , 21 mm Ø
2-601	IC tweezers , nickel-plated, 125 mm, for gripping, inserting and removing IC's
2-620	PLCC extractor , for easy removal of plug-in PLCC's
3-109-2	Side cutters , 120 mm, with wide, pointed head, special flat cutting edge, compression spring, for flush cutting, for soft wire up to 1.5 mm, chrome-plated, with transparent insulation
3-127-2	"Slimline" side cutters , 115 mm, for soft wire up to 1.0 mm, extremely slim head, box joint, compression spring, chrome-plated, with transparent insulation
3-445-2	Micro flat nose pliers , 120 mm, extremely slim, box joint, chrome-plated, with transparent insulation
3-481-2	Snipe nose pliers , 120 mm, angular, box joint, compression spring, chrome-plated, with transparent insulation
3-565	Water pump pliers , 120 mm, chrome-plated

No. Description of individual tools

4-103 S	Engineer's screwdriver with special square BERNSTEIN handle, blade made from chrome vanadium, chrome-plated, 100 x 4 mm
4-162	Electronics screwdriver with special handle and swivel top, blade chrome vanadium, chrome-plated, with black tip, 40 x 1.5 mm
4-163	Electronics screwdriver as above, blade 40 x 2.0 mm
4-165	Electronics screwdriver as above, blade 50 x 3.0 mm
4-282	Electronics cross-recess screwdriver with special handle and swivel top, blade chrome vanadium, chrome-plated, with black tip, 40 x 2.0 mm, size 00
4-283	Electronics cross-recess screwdriver as above, size 0
4-406	Retaining screwdriver , 80 x 4 mm
5-006	Component tweezers , nickel-plated, with insulated jaws, for easy insertion and removal of plug-in transistors of various sizes
5-107	Engineer's tweezers made from steel, with bent tips, 150 mm, nickel-plated
5-131	Watchmaker's tweezers , 110 mm, stainless, sharply-pointed
5-301	Special scissors , for cutting sheet-metal and wires, with serration, extremely slim, 110 mm, nickel-plated

To complete the set we recommend:

9-325	Plastic box , with hinged lid and adjustable compartments, 200 x 130 x 30 mm
	Shoulder strap

HANDY 1500 ELECTRONIC SERVICE CASE

The small and very handy service case with big space inside



1500 **BERNSTEIN** **HANDY** with tool set

1515 **BERNSTEIN** **HANDY** without tool set

Description:

Case-body made from deep-drawn, impact-resistant, grained black plastic shells, pressed on a stable alu-frame, dustproof and rainproof, acid- and scratch-resistant. It has loops at the sides for attaching a shoulder strap.

Fixed by stretch-ribbons, 41 special tools are clearly arranged on two swivel-tool-trays. A special pocket in the case-lid offers a lot of space for documents, pencils etc.. The bottom contains a stable plastic insert of 75 mm depth for spare parts, measuring instruments and soldering irons. 4 adjustable partitions allow a flexible division. For security purposes the case is equipped with 2 key-locks.

Outside dimensions: 340 x 360 x 180 mm

Weight without tools: approx. 3.300 kg

Weight with tools: approx. 4.300 kg

Tool set:

No.	Description of individual tools
1-152	Adjusting screwdriver , blade 40 x 4 mm
2-126	Desoldering lever , slotted at one end, with plastic handle
2-127	Tin knife , with plastic handle, 115 mm
2-132	Spring hook , nickel-plated and insulated, 175 mm
2-166	Contact cleaner , made from glass fibre
2-265	2 Test prods , red and black, extremely slim, pointed and flexible, blade made from 1 mm steel wire
2-275	Repair mirror , 21 mm Ø
2-601	IC tweezers , nickel-plated, 125 mm, for gripping, inserting and removing IC's
2-620	PLCC extractor , for easy removal of plug-in PLCC's
3-127-2	„Slimline“ side cutters , 115 mm, for soft wire up to 1.0 mm, extremely slim head, box joint, compression spring, chrome-plated, with transparent insulation
3-131-1	Side cutters , 120 mm, chrome-plated, for hard wire up to 0.8 mm, for soft wire up to 1.5 mm, with BERNSTEINIT insulation
3-445-2	Micro flat nose pliers , 120 mm, extremely slim, box joint, chrome-plated, with transparent insulation
3-481-2	Snipe nose pliers , 120 mm, angular, box joint, compression spring, chrome-plated, with transparent insulation
4-103 S	Engineer's screwdriver with special square BERNSTEIN handle, blade made from chrome vanadium, chrome-plated, 100 x 4 mm
4-271	Cross-recess screwdriver , Supadriv/Pozidriv, size 0, with special square pattern BERNSTEIN handle, blade made from chrome vanadium, nickel-plated, with black tip
4-272	Cross-recess screwdriver , Supadriv/Pozidriv, size 1, with special square pattern BERNSTEIN handle, blade made from chrome vanadium, nickel-plated, with black tip

No.	Description of individual tools
4-301	Miniature screwdriver , with plastic handle, blade nickel-plated 40 x 1.8 mm
4-311	Screwdriver for headless screws , with plastic handle, blade made from chrome vanadium, nickel-plated, 80 x 2.8 mm
4-343 VDE	Voltage tester , blade 60 x 3 mm
4-366	Cross-recess watchmaker's screwdriver , size 00
4-391	Watchmaker's screwdriver , nickel-plated, with 4 interchangeable blades, 1.5, 2.0, 2.5 and 3.0 mm
4-407	Retaining screwdriver , 110 x 4 mm
4-775	Plastic handle , 6 mm, for socket wrenches
5-006	Component tweezers , nickel-plated, with insulated jaws, for easy insertion and removal of plug-in transistors of various sizes
5-107	Engineer's tweezers made from steel, with bent tips, 150 mm, nickel-plated
5-181	Wire scraper , for wires 0.6 mm Ø, interchangeable cutter
5-301	Special scissors , for cutting sheet-metal and wires, with serrations, extremely slim, 110 mm, nickel-plated
5-515	Universal blade knife , with adjustable blade
6-202	Socket wrench , C.V. nickel-plated, 5.5 mm A/F, without handle
6-204	Socket wrench , C.V. nickel-plated, 7.0 mm A/F, without handle
6-771	Adjustable wrench , jaws opening 0 - 12 mm, total length 100 mm
6-820	Set of wrench keys , 8 pieces, in plastic wallet, 1.5, 2.0, 2.5, 3.0, 4.0, 5.0, 5.5 and 6.0 mm
7-425	Dust brush

TELE 1100 SERVICE CASE

The ideal case for the ambitious engineer



1100 **BERNSTEIN** TELE with tool set

1115 **BERNSTEIN** TELE without tool set

Description:

Attractive case made from deep-drawn, impact-resistant, dark brown grained plastic sections with a continuous bronze anodised aluminium frame, dustproof and rainproof, acid-resistant, scratch-resistant and non-slip.

Twenty tools are arranged handily on a hinged panel.

The back of the panel has elastic loops to take documents, measuring instruments, pcb's, etc. The lid of the case is padded with foam rubber.

The split plastic tray in the bottom of the case, which is intended to take spares, measuring and soldering equipment up to approx. 60 mm height, is covered by a foam padded perforated plate. 50 clips and 1 metre of elastic are provided to allow individual tool arrangements on this plate.

The case has a lock strip with 2 locks and is centrally lockable. It has loops at the sides for attaching a carrying strap.

Outside dimensions: 460 x 350 x 170 mm

Weight without tools: approx. 3.600 kg

Weight with tools: approx. 4.200 kg

Tool set:

No.	Description of individual tools	No.	Description of individual tools
1-335	Adjusting key , with bronze insert at both ends 1.7 x 0.7 mm	4-271	Cross-recess screwdriver , as above, Supadriv/Pozidriv, size 0, black tip
1-355	Adjusting key , with bronze insert at both ends 2.0 x 1.0 mm	4-272	Cross-recess screwdriver , as above, Supadriv/Pozidriv, size 1, black tip
1-909	Engineer's mirror with handle, made entirely from BERNSTEINIT	4-301	Miniature screwdriver , blade nickel-plated, 40 x 1.8 mm
2-127	Tin knife , with plastic handle, 115 mm	4-775	Plastic handle , 6 mm, for socket wrenches
2-265-1	Test prod , red, especially thin, pointed and flexible, blade made from 1 mm steel wire	5-107	Engineer's tweezers , made from steel, with bent tips, 150 mm, nickel-plated
2-265-2	Test prod , black, as above	5-121	Steel tweezers , straight, round, pointed, 120 mm, nickel-plated
3-126-2	Side cutters , 120 mm, for soft wire up to 1.0 mm, chrome-plated, with transparent insulation	5-261	Contact file , 150 mm
3-235-1	Telephone pliers with wire cutters, 145 mm, chrome-plated, with BERNSTEINIT insulation	6-202	Socket wrench , nickel-plated, 5.5 mm A/F, without handle
3-731-1	Combination pliers , 135 mm, chrome-plated, with BERNSTEINIT insulation	6-204	Socket wrench , nickel-plated, 7.0 mm A/F, without handle
4-103 S	Engineer's screwdriver with special square BERNSTEIN handle, blade made from chrome vanadium, chrome-plated, 100 x 4 mm	7-425	Dust brush

TELE 1150 SERVICE CASE

with the special tool set



1150 **BERNSTEIN** TELE with tool set

Description:

The case is equivalent to No. 1100, only the perforated plate has additional 18 tools, all together 38 tools.

Outside dimensions: 460 x 350 x 170 mm

Weight without tools: approx. 3.600 kg

Weight with tools: approx. 5.000 kg

Tool set:

No. Description of individual tools

1-335	Adjusting key , with bronze insert at both ends 1.7 x 0.7 mm
1-355	Adjusting key , with bronze insert at both ends 2.0 x 1.0 mm
1-909	Engineer's mirror with handle, made entirely from BERNSTEINIT
2-127	Tin knife , with plastic handle, 115 mm
2-132	Spring hook , nickel-plated and insulated, 175 mm
2-166	Contact-cleaner , made from glass fibre
2-265-1	Test prod , red, especially thin, pointed and flexible, blade made from 1 mm steel wire
2-265-2	Test prod , black, as above
2-601	IC tweezers for gripping, inserting and removing, especially suitable for narrow components, nickel-plated
3-126-2	Side cutters , 120 mm, for soft wire up to 1.0 mm, chrome-plated, with transparent insulation
3-235-1	Telephone pliers with wire cutters, 145 mm, chrome-plated, with BERNSTEINIT insulation
3-731-1	Combination pliers , 135 mm, chrome-plated, with BERNSTEINIT insulation
4-103 S	Engineer's screwdriver with special square BERNSTEIN handle, blade made from chrome vanadium, chrome-plated, 100 x 4 mm
4-222	Screwdriver , as above, 260 x 3.0 mm, black tip
4-223	Screwdriver , as above, 260 x 4.5 mm, black tip
4-227	Cross-recess screwdriver , as above, size 1, blade 300 mm, black tip
4-271	Cross-recess screwdriver , as above, Supadriv/Pozidriv, size 0, black tip

No. Description of individual tools

4-272	Cross-recess screwdriver , as above, Supadriv/Pozidriv, size 1, black tip
4-301	Miniature screwdriver , blade nickel-plated, 40 x 1.8 mm
4-343 VDE	Voltage tester , blade 60 x 3 mm
4-366	Cross-recess watchmaker's screwdriver , size 00
4-367	Cross-recess watchmaker's screwdriver , size 0
4-368	Cross-recess watchmaker's screwdriver , size 1
4-404	Retaining screwdriver , 295 x 4 mm
4-775	Plastic handle , 6 mm, for socket wrenches
5-006	Component tweezers , nickel-plated, with insulated jaws
5-107	Engineer's tweezers , made from steel, with bent tips, 150 mm, nickel-plated
5-115	Heat dissipating tweezers , 165 mm, nickel-plated
5-121	Steel tweezers , straight, round, pointed, 120 mm, nickel-plated
5-261	Contact file , 150 mm
5-301	Special sheet-metal scissors , serrated, extremely slim, 110 mm, nickel-plated
6-202	Socket wrench , nickel-plated, 5.5 mm A/F, without handle
6-204	Socket wrench , nickel-plated, 7.0 mm A/F, without handle
6-962	TORX-screwdriver , with special square BERNSTEIN handle, blade made from chrome vanadium, chrome-plated, black tip, size T 7
6-963	TORX-screwdriver , as above, size T 8
6-965 L	TORX-screwdriver , as above, size T 10
6-966 L	TORX-screwdriver , as above, size T 15
7-425	Dust brush

PRESTIGE 1200 SERVICE BOX

Multi-purpose aluminium box for the discerning service engineer



1200 **BERNSTEIN** PRESTIGE with tool set

1215 **BERNSTEIN** PRESTIGE without tool set

Description:

Box made from distortion-free aluminium, dustproof and rainproof. Box lining made from black, grained Aero-Fiber.

Tools, technical documents, soldering iron (naturally also when hot) etc. can be housed in a clear arrangement in the lid and on the hinged tools cover plate.

A thick foamed plastic pad on the back of the cover plate protects delicate equipment in the bottom of the box from being damaged.

The bottom of the box can be divided up to suit individual requirements. Grid spacings of 10 mm permit adjustment to any size.

Two longitudinal dividers and 7 partitions supplied as standard.

The box has 2 locks.

Outside dimensions: 435 x 375 x 155 mm

Weight without tools: approx. 4.500 kg

Weight with tools: approx. 6.200 kg

Tool set:

No.	Description of individual tools	No.	Description of individual tools
1-180	7-piece adjusting screwdriver set in plastic case. Contents: 1-151 Adjusting screwdriver, blade 40x3.0 mm 1-152 Adjusting screwdriver, blade 40x4.0 mm 1-153 Adjusting screwdriver, blade 130x2.0 mm 1-155 Adjusting screwdriver, blade 130x3.5 mm 1-181 Adjusting key, hexagonal jaw at one end, 1.85 mm A/F opposite end rectangular, 1.5 mm A/F 1-182 Adjusting key, hexagonal jaw at one end, 2.6 mm A/F, opposite end rectangular, 3.0 mm A/F 1-306 Adjusting screwdriver, blade 80 mm long, with bronze insert 1.7x0.7 mm	4-102 S	Engineer's screwdriver with special square BERNSTEIN handle, blade made from chrome vanadium, chrome-plated, 75x3.5 mm
1-909	Engineer's mirror with handle, made entirely from BERNSTEINIT	4-103 S	Engineer's screwdriver as above, blade 100x4 mm
2-265	2 test prods , red and black, especially thin, pointed and flexible, blade made from 1 mm steel wire	4-104 S	Engineer's screwdriver as above, blade 150x5 mm
3-127-2	Slimline side cutters , 115 mm, for soft wire up to 1.0 mm, extremely narrow head, box joint, compression spring, chrome-plated, with transparent insulation	4-115 S	Engineer's screwdriver as above, blade 200x3 mm
3-133-1	Side-cutters , 145 mm, for hard wire, chrome-plated, with BERNSTEINIT insulation	4-251	Cross-recess screwdriver with plastic handle, blade made from chrome vanadium, nickel-plated, size 0
3-215-1	Engineer's pliers , 185 mm, bent snipe nose, box joint, chrome-plated, with BERNSTEINIT insulation	4-252	Cross-recess screwdriver as above, size 1
3-235-1	Telephone pliers , 145 mm, with wire cutter, chrome-plated with BERNSTEINIT insulation	4-301	Miniature screwdriver with plastic handle, blade nickel-plated, 40x1.8 mm
3-455-2	Mikro pointed pliers , 120 mm, extremely light and slim, box joint, chrome-plated, with transparent insulation	4-311	Screwdriver for grub screws with plastic handle, blade made from chrome vanadium, nickel-plated, 80x2.8 mm
3-565	Water pump pliers , 120 mm, chrome-plated	4-343 VDE	Voltage tester , blade 60x3 mm
3-732-1	Combination pliers , 160 mm, chrome-plated, with BERNSTEINIT insulation	4-391	Watchmaker's screwdriver , nickel-plated, with 4 interchangeable blades, 1.5, 2.0, 2.5 and 3.0 mm
		4-407	Screw holder , 110 x 4 mm
		5-006	Transistor tweezers , nickel-plated, with insulation jaws, for easy removal and insertion of plug-in transistors of various sizes
		5-107	Steel tweezers with bent tips, 150 mm, nickel-plated
		5-117	Steel tweezers , straight - flat - wide, 145 mm, nickel-plated
		5-261	Contact file
		5-301	Special sheet-metal scissors , serrated, extremely slim, 110 mm, nickel-plated
		6-155	Socket wrench with plastic handle, blade made from chrome vanadium, nickel-plated, 100 x 5.5 mm A/F
		6-157	Socket wrench as above, blade 100x7 mm A/F
		7-425	Dust brush
		8-401	Carded solder , approx. 1 m
		8-145	ERSA Soldering iron 30 W, 220 V, with plastic handle
	To complete the set we recommend:		
9-325	Plastic box with hinged lid and adjustable compartments, 200x130x30 mm		

PRAXIS 1750 ELECTRONIC SERVICE CASE

Flat tool case with special styling

1750 **BERNSTEIN** PRAXIS with tool set

1755 **BERNSTEIN** PRAXIS without tool set

Description:

Elegant briefcase in impact-resistant, double-walled grained black plastic. The tools are clearly arranged in 2 pivoting tool trays. A document compartment is provided on the back of one tool tray. The bottom of the case has a deep-drawn tray, 30 mm high, with dividers of differing sizes and a special holder for a hot soldering iron. The case has 2 locks.



Outside dimensions: 435 x 325 x 85 mm

Weight without tools: approx. 3.000 kg

Weight with tools: approx. 4.200 kg

Tool set:

No.	Description of individual tools	No.	Description of individual tools
1-151	Adjusting screwdriver , blade 40x3 mm	4-343 VDE	Voltage tester , blade 60x3 mm
2-126	Desoldering lever , slotted at one end, with plastic handle	4-351	Offset screwdriver , chrome vanadium, nickel-plated, 100x5 mm
2-132	Spring hook , nickel-plated and insulated, 175 mm	4-366	Cross-recess watchmaker's screwdriver , size 00
2-265	2 Test prods , red and black, extremely slim, pointed and flexible, blade made from 1 mm steel wire	4-391	Watchmaker's screwdriver , nickel-plated, with 4 interchangeable blades, 1.5, 2.0, 2.5, 3.0 mm
3-127-2	Slimline side cutters , 115 mm, for soft wire up to 1 mm, extremely slim head, box joint, compression spring, chrome-plated, with transparent insulation	4-407	Screw holder , 110x4 mm
3-131-1	Side cutters , 120 mm, for hard wire up to 0.8 mm, for soft wire up to 1.5 mm, chrome-plated, with BERNSTEINIT insulation	4-775	Plastic handle , 6 mm, for socket-spanner
3-445-2	Micro flat-nose pliers , 120 mm, box joint, chrome-plated, with transparent insulation	5-006	Component tweezers , nickel-plated, with insulated jaws, for easy insertion and removal of plug-in transistors of various sizes
3-455-2	Micro snipe-nose pliers , 120 mm, oval-pointed design, box joint, chrome-plated, with transparent insulation	5-107	Engineer's tweezers , made from steel, with bent tips, 150 mm, nickel-plated
3-565	Miniature water-pump pliers , 120 mm, chrome-plated	5-115	Heat dissipating tweezers , 165 mm, nickel-plated, for use when soldering transistors, gold-bonded diodes etc.
4-102 S	Engineer's screwdriver with special square pattern BERNSTEIN handle, blade made from chrome vanadium, chrome-plated, 75 x 3.5 mm	5-117	Engineer's tweezers , made from steel, straight-flat-wide, 145 mm, nickel-plated
4-103 S	Engineer's screwdriver as above, blade 100x4 mm	5-201/6	Needle files , set of 6 pieces
4-104 S	Engineer's screwdriver as above, blade 150x5 mm	5-301	Special scissors for cutting sheet-metal and wires, with serration, extremely slim, 110 mm, nickel-plated
4-271	Cross-recess screwdriver , Supadriv/Pozidriv, size 0, with special square pattern BERNSTEIN handle, blade made from chrome vanadium, nickel-plated, with black tip	5-501	Cable knife
4-272	Cross-recess screwdriver , Supadriv/Pozidriv, as above, size 1	6-202	Socket spanner , without handle, 5.5 mm, made from chrome vanadium, nickel-plated
4-301	Miniature screwdriver , with plastic handle, blade nickel-plated, 40x1.8 mm	6-204	Socket spanner as above, 7.0 mm
4-311	Screwdriver for headless screws , with plastic handle, blade made from chrome vanadium, nickel-plated, 80x2.8 mm	6-820	Set of allen hex sockets , 8 pieces, in plastic wallet, 1.5, 2.0, 2.5, 3.0, 4.0, 5.0, 5.5, 6.0 mm
		7-425	Dust brush
		7-505	Roller tape measure , 1 m

To complete the set we recommend:

9-325 **Plastic box** with hinged lid and adjustable compartments, 200x130x30 mm

ELECTRONICA 2000 SERVICE SET

The practical service case for the electronics engineer



2000 **BERNSTEIN ELECTRONICA** with tool set

2024 **BERNSTEIN ELECTRONICA** with tool set and ERSA Multitip soldering iron 15 W, 220 V (No. 8-135)

2001 Case with zip fastener, without tools

Description:

Elegant case with zip fastener made from black imitation leather with pockets for tools and notes. The case, which contains 18 clearly arranged special tools, can also carry a soldering iron. In addition to writing materials, the writing case side has room in its 3 compartments for a writing block, leaflets and technical documents. There is also a transparent window for visiting cards or calendars and a pocket for small parts.

Outside dimensions: 330 x 235 x 50 mm (when closed)

Weight with tools: approx. 1.050 kg

Tool set:

No.	Description of individual tools	No.	Description of individual tools
1-303	Adjusting screwdriver , blade 155 x 2.8 mm, with bronze insert 2.5 x 0.5 mm	3-445-2	Micro flat nose pliers , 120 mm, box joint, extremely light and slim, chrome-plated, with transparent insulation
1-304	Adjusting screwdriver , blade 155 x 2.8 mm, with bronze insert 1.7 x 0.7 mm	3-455-2	Micro pointed pliers , 120 mm, snipe nose, box joint, extremely light and slim, chrome-plated, with transparent insulation
1-305	Adjusting screwdriver , blade 80 x 2.5 mm, with bronze insert 1.1 x 0.5 mm	4-102 S	Engineer's screwdriver with special square BERNSTEIN handle, blade made from chrome vanadium, chrome-plated, 75 x 3.5 mm
1-971	Adjusting screwdriver , blade 80 x 2.0 mm, blade made from hard special plastic	4-301	Miniature screwdriver with plastic handle, blade nickel-plated, 40 x 1.8 mm
2-126	Desoldering bar , slotted at one end, nickel-plated, insulated, with plastic handle	4-311	Screwdriver for grub screws , with plastic handle, blade made from chrome vanadium, nickel-plated, 80 x 2.8 mm
2-127	Tin knife with pointed, sharp blade, high quality steel, for cutting circuit paths and for burring	5-006	Transistor tweezers , nickel-plated, with insulated jaws; for easy removal and insertion of plug-in transistors of various sizes, 140 mm
2-165	Contact cleaner , brush-shaped, with wire bristles	5-107	Steel tweezers with bent tips, 150 mm, nickel-plated
3-125-2	Micro side cutters , 110 mm, for soft wire up to 0.8 mm, slim, pointed head, box joint, compression spring, chrome-plated, with transparent insulation	5-115	Heat dissipating tweezers , made from steel, the flat, wide points of the tweezers are narrow and provided with copper jaws, for use when soldering transistors, gold-bonded diodes etc., 165 mm, nickel-plated
3-165-2	End cutters for electronics , 160 mm, with angular tip and cutting edge for soft wire up to 1.0 mm, box joint, chrome-plated, with transparent insulation		
3-435-2	Micro round nose pliers , 120 mm, box joint, extremely light and slim, chrome-plated, with transparent insulation		

2100 TELEVISION SERVICE CASE

The service tool case for the quick service



2100 **BERNSTEIN** TELEVISION SERVICE CASE with tool set

2101 Case with zip fastener, without tools

Description:

Black imitation leather case with all-round zip fastener and black and red lining. A good assortment of 22 tools for the television engineer is clearly arranged in pockets. There are also 2 flap pockets for tin solder, fuses, spares etc.

Outside dimensions: 335 x 260 x 55 mm (when closed)

Weight with tools: approx. 1.500 kg

Tool set:

No.	Description of individual tools	No.	Description of individual tools
1-151	Adjusting screwdriver , blade 40 x 3.0 mm	4-104 S	Engineer's screwdriver with special square BERNSTEIN handle, blade made from chrome vanadium, chrome-plated, 150 x 5.0 mm
1-153	Adjusting screwdriver , blade 130 x 2.0 mm	4-255	Cross recess screwdriver with special square BERNSTEIN handle, blade made from chrome vanadium, chrome-plated, with black tip, size 0
1-157	Adjusting screwdriver , blade 190 x 3.0 mm	4-301	Miniature screwdriver with plastic handle, blade nickel-plated, 40 x 1.8 mm
1-181	Double-ended adjusting key with hexagon = 1.85 mm A/F and square = 1.5 mm A/F blade	4-311	Screwdriver for grub screws , with plastic handle, blade made from chrome vanadium, nickel-plated, 80 x 2.8 mm
1-909	Engineer's mirror with extending handle, made entirely from BERNSTEINIT	4-343VDE	Voltage tester according to VDE, nickel-plated, fully insulated, blade 60 x 3.0 mm
2-127	Tin knife with pointed, sharp blade, high quality steel, for cutting circuit paths and for burring	4-407	Retaining screwdriver , nickel-plated, blade 110 x 4.0 mm
2-236	Tapping hammer from BERNSTEINIT, 170 mm long	5-117	Steel tweezers , straight, flat, wide, 145 mm, nickel-plated
3-132-1	Side cutters , 130 mm, for hard wire up to 1.0 mm, chrome-plated, polished, with BERNSTEINIT insulation	5-261	Contact file
3-235-1	Telephone pliers with wire cutter, 145 mm, chrome-plated, polished, with BERNSTEINIT insulation	7-425	Dust brush
3-565	Water pump pliers , 120 mm, chrome-plated, polished	8-401	Carded solder , approx. 1 m
4-103 S	Engineer's screwdriver with special square BERNSTEIN handle, blade made from chrome vanadium, chrome-plated, 100 x 4.0 mm	8-145	ERSA Soldering iron 30 W, 220 V

ANTISTATIC 2200 SERVICE-SET

The tool set for mobile use at electrostatically endangered components



2200 **BERNSTEIN** SERVICE-SET ANTISTATIC with tool set

2201 Case with zip fastener, without tools

Description:

Elegant, black zipper case, with wine red lining and transparent pockets for 12 tools and a foldable antistatic workbench pad with accessories.

Outside dimensions: 320 x 250 x 50 mm (when closed)

Weight with tools: approx. 0.950 kg

Tool set:

No.	Description of individual tools	No.	Description of individual tools
2-620	PLCC extractor	4-622	Cross-recess screwdriver with conductive handle, blade from chrome vanadium, chrome-plated, with black tip, size 00
3-601-13	Side cutters , 125 mm, for hard wire up to 0.4 mm, for soft wire up to 1.0 mm, steel-polished, box joint, double leaf spring, with conductive black hand-guard	4-623	Cross-recess screwdriver with conductive handle, blade from chrome vanadium, chrome-plated, with black tip, size 0
3-632-13	Flat nose pliers , 125 mm, steel-polished, box joint, double leaf spring, with conductive black hand-guard	5-191	Tweezers , made from conductive plastic material, reinforced with glassfibre, 120 mm, with straight, rounded tips
3-633-13	Snipe nose pliers , 125 mm, steel-polished, box joint, double leaf spring, with conductive black hand-guard	5-192	Tweezers , made from conductive plastic material, reinforced with glassfibre, 120 mm, with straight, 3 mm flat-hand tips
4-601	Screwdriver with conductive handle, blade from chrome vanadium, chrome-plated, with black tip, 50 x 0.8 mm	9-354	ESD handling set , consisting of: foldable, green workbench pad (surface resistance according to DIN 53482: approx. 10 ⁹ ohm), 500 x 400 x 0.35 mm, contact bracelet 9-342, earth wire 2500 mm long with 1 Mohm safety resistor
4-605	Screwdriver with conductive handle, blade from chrome vanadium, chrome-plated, with black tip, 60 x 2.0 mm		
4-606	Screwdriver with conductive handle, blade from chrome vanadium, chrome-plated, with black tip, 60 x 2.5 mm		
4-621	Cross-recess screwdriver with conductive handle, blade from chrome vanadium, chrome-plated, with black tip, size 000		

ESD/EGB 2300 SERVICE SET

Special tool set for repair and maintenance of electrostatically endangered components



2300 **BERNSTEIN** ESD/EGB Service set with tools

Description:

The foldable green portfolio at the same time serves as an electrically conductive workbench pad of 680 x 680 x 0.35 mm. The surface resistance according to DIN 53482 is approx. 10⁹ ohm.

The workbench pad has 3 press-stud receptacles for connecting the contact bracelet and the earth wire. With 2 additional press-buttons the pad may be closed as tool bag.

The 2 patch pockets carry the contact bracelet and the earth wire. Furthermore 16 conductive tools are placed in pockets, ready to hand.

Outside dimensions: 330 x 240 x 20 mm (when closed)

Weight with tools: approx. 0.850 kg

Tool set:

No.	Description of individual tools	No.	Description of individual tools
2-166	Glass fibre contact cleaner , with rotary mechanism, plastic casing	5-191	Tweezers made from conductive, black plastic material, reinforced with glass fibre, 120 mm, with rounded tips
2-620	PLCC-extractor	5-194	Tweezers made from conductive, black plastic material, reinforced with glass fibre, 120 mm, with bent, pointed tips
3-601-13	Side cutters , 125 mm, for hard wire up to 0.4 mm, for soft wire up to 1.0 mm, steel-polished, box joint, double leaf spring, with conductive black hand-guard	6-616	Socket wrench with conductive handle, blade made from chrome vanadium, nickel-plated, A/F 3.5 mm
3-633-13	Snipe nose pliers , 125 mm, steel-polished, box joint, double leaf spring, with conductive black hand-guard	6-661	TORX screwdriver with conductive handle, blade made from chrome vanadium, chrome-plated, with black tip, T 5
4-601	Screwdriver with conductive handle, blade made from chrome vanadium, with black tip, 50 x 0.8 mm	6-664	TORX screwdriver with conductive handle, blade made from chrome vanadium, chrome-plated, with black tip, T 8
4-605	Screwdriver with conductive handle, blade made from chrome vanadium, with black tip, 60 x 2.0 mm	6-666 L	TORX screwdriver with conductive handle, blade made from chrome vanadium, chrome-plated, with black tip, T 10
4-606	Screwdriver with conductive handle, blade made from chrome vanadium, with black tip, 60 x 2.5 mm	9-342	Contact bracelet cloth armband, allergy-free, edges and surface insulating, spiral cord, 1 Mohm safety resistor, combined press-stud and terminal connection, to DIN EN 100 015/1
4-621	Cross-recess screwdriver with conductive handle, blade made from chrome vanadium, chrome-plated, with black tip, size 000	9-346	Earth wire with 1 Mohm safety resistor, 2500 mm long, with terminal connection resp. press-stud, for connecting workbench pad and floor cover and connection to an earth potential
4-622	Cross-recess screwdriver with conductive handle, blade made from chrome vanadium, chrome-plated, with black tip, size 00		
4-623	Cross-recess screwdriver with conductive handle, blade made from chrome vanadium, chrome-plated, with black tip, size 0		

ELECTRONIC-SERVICE TOOL SETS

Special service sets for the maintenance and repairing of mobile phones and other high sensitive IT- instruments

The tools are clearly arranged in handy black imitation leather cases with zip fastener and velvet grey lining.

2251 Case with zip fastener, without tools

Outside dimensions: 190 x 135 x 35 mm (when closed)

2250 **BERNSTEIN** CARAT with tool set

9-piece set **conductive tools** from the series EUROline-Conductive, with bright-burnished, fine-polished pliers and bi-coloured conductive hand-guard, to meet the most exacting standards.

Weight with tools: approx. 0.360 g



2260 **BERNSTEIN** SELECT with tool set

9-piece set of tools from the series EUROline, with high quality tools

Weight with tools: approx. 0.360 kg

Tool set:

No.	Description of individual tools
3-651-14	EUROline-mini side cutters 120 mm, for copper wire up to 1.2 mm and soft wire up to 0.6 mm, fine polished - bright burnished, with bi-coloured hand-guard
3-683-14	EUROline-snipe nose pliers , 130 mm, plain jaws, bright burnished
4-161	Screwdriver for slotted screws , chrome vanadium, blade 40 x 1.0 mm, chrome plated, with special handle and swivel top
4-163	Screwdriver for slotted screws , chrome vanadium, blade 40 x 2.0 mm, chrome-plated, with special handle and swivel top
4-281	Cross-recess screwdriver , size 000, chrome vanadium, chrome-plated, with special handle and swivel top
4-283	Cross-recess screwdriver , size 0, chrome vanadium, chrome-plated, with special handle and swivel top
5-121	Engineer's tweezers , straight, round-pointed, 120 mm, nickel-plated
6-681	TORX-Screwdriver T 5 , chrome vanadium, chrome-plated, with special handle and swivel top
6-682	TORX-Screwdriver T 6 , chrome vanadium, chrome-plated, with special handle and swivel top

2270 **BERNSTEIN** ACCENT with tool set

9-piece set **conductive tools** with bright steel polished pliers and black, conductive hand-guard

Weight with tools: approx. 0.360 kg



Tool set:

No.	Description of individual tools
3-672-15	End cutters EUROline-Conductive , 130 mm, for copper wire up to 0.6 mm, fine polished - bright burnished
3-683-15	Snipe nose pliers EUROline-Conductive , 130 mm, plain jaws, fine polished - bright burnished
4-601	Screwdriver for slotted screws with conductive handle, chrome vanadium, chrome-plated, blade 50 x 0.8 mm
4-603	Screwdriver for slotted screws with conductive handle, chrome vanadium, chrome-plated, blade 50 x 1.5 mm
4-621	Cross-recess screwdriver , size 000, with conductive handle, chrome vanadium, chrome-plated
4-623	Cross-recess screwdriver , size 0, with conductive handle, chrome vanadium, chrome-plated
5-191	Tweezers made from conductive and acid-resistant black plastic, glassfibre reinforced
6-661	TORX-Screwdriver T 5 , with conductive handle, chrome vanadium, chrome-plated, with black tip
6-663	TORX-Screwdriver T 7 , with conductive handle, chrome vanadium, chrome-plated, with black tip



Tool set:

No.	Description of individual tools
3-601-13	Side cutter , 120 mm, for hard wire up to 0.4 mm and soft wire up to 1.0 mm
3-633-13	Snipe nose pliers , 120 mm, plain jaws
4-601	Screwdriver for slotted screws , with conductive handle, chrome vanadium, chrome-plated, blade 50 x 0.8 mm
4-603	Screwdriver for slotted screws , with conductive handle, chrome vanadium, chrome-plated, blade 50 x 1.5 mm
4-621	Cross-recess screwdriver , size 000, with conductive handle, chrome vanadium, chrome-plated
4-623	Cross-recess screwdriver , size 0, with conductive handle, chrome vanadium, chrome-plated
5-191	Tweezers made from conductive and acid-resistant black plastic, glassfibre reinforced
6-661	TORX-Screwdriver T 5 , with conductive handle, chrome vanadium, chrome-plated, with black tip
6-663	TORX-Screwdriver T 7 , with conductive handle, chrome vanadium, chrome-plated, with black tip

RADIO-TV-SERVICE TOOL ROLLS

The tool rolls are made from a durable cotton canvas, outside black, inside grey

2400 **BERNSTEIN** TV Service tool roll with 24 piece tool set

2401 Tool roll without tools

Weight with tools: approx. 1.700 kg

Tool set:

No.	Description of individual tools
1-459	Adjusting screwdriver , 200 mm long, blade widths 3.5 and 5.0 mm
2-234	High voltage mains tester , 190 mm long
2-236	Tapping hammer
3-132-1	Side cutter , 130 mm, for hard wire, chrome-plated, insulated
3-205-1	Engineer's flat pliers , 185 mm, box joint, chrome-plated, insulated
3-215-1	Engineer's pliers , 180 mm, bent snipe nose, chrome-plated, insulated
3-225-1	Engineer's precision pliers , 135 mm, snipe nose, chrome-plated, insulated
3-335-1	Adjusting pliers , 135 mm, straight, flat, wide, chrome-plated, insulated
3-565	Water pump pliers , 120 mm, chrome-plated
4-103 S	Engineer's screwdriver , with special square BERNSTEIN handle, blade made from chrome vanadium, chrome-plated, 100 x 4 mm
4-104 S	Engineer's screwdriver as above, blade 150 x 5 mm
4-105 S	Engineer's screwdriver as above, blade 200 x 6 mm
4-115-1 S	Engineer's screwdriver as above, blade 200 x 3 mm, insulated
4-311	Screwdriver for grub screws , blade C.V., 80 x 2.8 mm
4-408	Screw holder , nickel-plated, blade 200 x 4 mm
5-107-1	Steel tweezers with bent tips, 150 mm, nickel-plated
5-231	Flat file with handle
5-261	Contact file
5-301	Special sheet-metal scissors , serrated, extremely slim, 110 mm
6-105	Socket wrench , blade C.V., chrome-plated, 140 x 5.5 mm A/F
6-107	Socket wrench as above, blade 140 x 7 mm A/F
7-425	Dust brush
8-145	Soldering iron , 30 W, 220 V
8-401	Carded solder , approx. 1 m



2800 **BERNSTEIN** tool roll with 18-piece tool set

2801 Tool roll without tools

Weight with tools: approx. 1.450 kg

Tool set:

No.	Description of individual tools
2-236	Tapping hammer
3-133-1	Side cutter , 145 mm, for hard wire, chrome-plated, insulated
3-205-1	Engineer's flat pliers , 185 mm, box joint, chrome-plated, insulated
3-245-1	Telephone pliers with wire cutters, 200 mm, snipe nose, long, straight
3-255-1	Telephone pliers with wire cutters, 200 mm, long, bent snipe nose
3-732-1	Combination pliers , 160 mm, chrome-plated, insulated
4-102 S	Engineer's screwdriver , blade chrome-plated, 75 x 3.5 mm
4-103 S	Engineer's screwdriver as above, blade 100 x 4 mm
4-104 S	Engineer's screwdriver as above, blade 150 x 5 mm
4-105 S	Engineer's screwdriver as above, blade 200 x 6 mm
4-311	Screwdriver for grub screws , blade C.V., 80 x 2.8 mm
4-316	Radio screwdriver , nickel-plated blade 60 x 3 mm
5-107	Steel tweezers with bent tips, 150 mm, nickel-plated
5-121	Steel tweezers straight, round and pointed, 120 mm, nickel-plated
5-125	Sheet-metal tweezers straight, flat and pointed, 110 mm, nickel-plated
5-261	2 contact files
5-301	Special sheet-metal scissors , serrated, extremely slim, 110 mm



2850 **BERNSTEIN** tool roll with 10-piece tool set

2851 Tool roll without tools

Weight with tools: approx. 0.900 kg

Tool set:

No.	Description of individual tools
2-236	Tapping hammer
3-132-1	Side cutter , 130 mm, for hard wire, chrome-plated, insulated
3-205-1	Engineer's flat pliers , 185 mm, box joint, chrome-plated, insulated
3-235-1	Telephone pliers with wire cutters, 145 mm, chrome-plated, insulated
3-255-1	Telephone pliers with wire cutters, 200 mm, long, bent snipe nose
4-102 S	Engineer's screwdriver , blade chrome-plated, 75 x 3.5 mm
4-103 S	Engineer's screwdriver as above, blade 100 x 4 mm
4-104 S	Engineer's screwdriver as above, blade 150 x 5 mm
4-311	Screwdriver for grub screws , blade C.V., 80 x 2.8 mm
5-107	Steel tweezers with bent tips, 150 mm, nickel-plated



EUROline 2600 SERVICE SET

The high quality service equipment for the electronics engineer



2600 **BERNSTEIN** EUROline with tool set

2601 Case with zip fastener, without tools

Description:

Black imitation leather case with zip fastener and velvet grey lining.

22 tools are clearly arranged in pockets made from black imitation leather. For taking CD-ROM, discs or other documents an elastic loop is fixed.

The selected electronics pliers and screwdrivers are from the BERNSTEIN „EUROline“-range.

The CD in the above picture is not included.

Outside dimensions: 320 x 250 x 50 mm (when closed)

Weight with tools: approx. 0.900 kg

Tool set:

No.	Description of individual tools	No.	Description of individual tools
1-735	Adjusting screwdriver handle , double-ended, for blades with 3 mm Ø	4-162	Electronics screwdriver with special handle and swivel top, blade made from chrome vanadium, chrome-plated, with black tip, 40 x 1.5 mm
1-738	Special hard plastic bit , blade Ø 3 mm, tip 1.5 x 0.5 mm	4-165	Electronics screwdriver as above, 50 x 3.0 mm
1-739	Special hard plastic bit , blade Ø 3 mm, tip 3.0 x 0.5 mm	4-281	Electronics cross-recess screwdriver as above, size 000
2-127	Tin knife with plastic handle, 115 mm	4-282	Electronics cross-recess screwdriver as above, size 00
2-166	Glass fibre contact cleaner	4-283	Electronics cross-recess screwdriver as above, size 0
2-265	2 test prods , red and black, extremely slim, pointed and flexible, blade made from 1 mm steel wire	5-006-7	Component tweezers , stainless, non-reflective, with insulated jaws, 140 mm
2-620	PLCC extractor	5-051	SMD tweezers , anti-magnetic, non-reflective, straight, pointed, 115 mm
3-655-14	EUROline side cutters , 120 mm, with slim, rounded head, without side face, box joint, double leaf spring, fine-polished and bright-burnished, bicolour insulation	5-052	SMD tweezers , anti-magnetic, non-reflective, bent, very sharply pointed, 110 mm
3-672-14	EUROline end cutters , 130 mm, 20° angular without side face, box joint, double leaf spring, fine-polished and bright-burnished, bicolour insulation	5-062	SMD tweezers , anti-magnetic, non-reflective, bent, flat tips, with gripping cavity, 115 mm
3-683-14	EUROline snipe nose pliers , 130 mm, plain jaws, box joint, double leaf spring, fine-polished and bright-burnished, bicolour insulation	6-681	TORX screwdriver with special handle and swivel top, blade made from chrome vanadium, chrome-plated, with black tip, size T 5
		6-683	TORX screwdriver with special handle and swivel top, blade made from chrome vanadium, chrome-plated, with black tip, size T 7

NETWORK 2700 SERVICE SET

The set with all essential tools for the assembly and maintenance of networks



2700 **BERNSTEIN** NETWORK with tool set

2701 Case with zip fastener, without tools

Description:

In an elegant black nylon case with zip fastener and velvet grey lining 23 special tools are clearly arranged in pockets.

Outside dimensions: 320 x 250 x 100 mm (when closed)

Weight with tools: 2.750 kg

Tool set:

No.	Description of individual tools	No.	Description of individual tools
2-601	IC-tweezers, nickel-plated , 125 mm, for gripping, inserting and removing IC's	5-161	Clamping scissors , 130 mm, stainless, with serrated gripping jaws
3-125-1	Micro side cutters , 110 mm, for soft wire up to 0.8 mm and hard wire up to 0.3 mm, chrome-plated, with BERNSTEINIT-insulation	5-0601	Rotary coaxial cable stripper for cable types RG 58, RG 59 and RG 62
3-235-1	Telephone pliers , 145 mm, chrome-plated, with BERNSTEINIT-insulation	4-775	Plastic sprung handle for socket wrenches
3-815-1	Wire strippers , 155 mm, with adjusting screw for all wire thicknesses, chrome-plated, with BERNSTEINIT-insulation	6-203	Socket wrench , 6.0 mm, chrome vanadium, nickel plated, without handle
3-0605	Combination-crimping pliers for connector types, 6P/6C, 6P/4C, 6P/2C, 8P/8C	6-205	Socket wrench , 8.0 mm, chrome vanadium, nickel plated, without handle
3-0611	Crimping pliers for BNC- and TNC-coaxial connectors	6-207	Socket wrench , 10.0 mm, chrome vanadium, nickel plated, without handle
4-141	Screwdriver with special square BERNSTEIN handle, blade made from chrome vanadium, 75 x 3.5 mm, chrome-plated, with black tip	6-772	Adjustable wrench , chrome vanadium, 150 mm, jaw opening 0 - 18 mm
4-143	Screwdriver as above, 125 x 5.5 mm, chrome-plated, with black tip	6-965 L	TORX-Screwdriver , size T 10, with bore-hole in the tip, with special square BERNSTEIN handle, blade made from chrome vanadium, chrome-plated, black tip
4-255	Cross-recess screwdriver size 0, with special square BERNSTEIN handle, blade made from chrome vanadium, chrome-plated, with black tip, blade length 60 mm	6-966 L	TORX-Screwdriver , size T 15, as above, with bore-hole in the tip
4-256	Cross-recess screwdriver size 1, as above, blade length 80 mm	6-967 L	TORX-Screwdriver , size T 20, as above, with bore-hole in the tip
4-257	Cross-recess screwdriver size 2, as above, blade length 100 mm	8-390	Desoldering pump , 195 mm long, 20 mm Ø
		8-396	Gas soldering iron , 10 - 60 W

MASTER 3000 SERVICE CASE

The indispensable pouch-style service case for the discerning engineer



3000 **BERNSTEIN** MASTER with tool set

3015 **BERNSTEIN** MASTER without tool set

Description:

Elegant black grained leather case with all-round zip fastener and red plastic lining. The set comprises 19 of the most important BERNSTEIN tools for service work. The BERNSTEIN Master can be kept at hand in the glove compartment of your car.

Outside dimensions: 245 x 130 x 60 mm (when closed)

Weight with tools: approx. 1.250 kg

Tool set:

No. Description of individual tools

1-153	Adjusting screwdriver , blade 130 x 2 mm
1-154	Adjusting screwdriver , blade 130 x 3 mm
3-131-1	Side cutters , 120 mm, for hard wire up to 0.8 mm, for soft wire up to 1.5 mm, chrome-plated, with BERNSTEINIT insulation
3-235-1	Telephone pliers with wire cutters, 145 mm, chrome-plated, with BERNSTEINIT insulation
3-511-1	Flat pliers , 120 mm, chrome-plated, with BERNSTEINIT insulation
3-565	Water pump pliers , 120 mm, chrome-plated
4-103 S	Engineer's screwdriver , with special square BERNSTEIN handle, blade made from chrome vanadium, chrome-plated, 100 x 4 mm
4-311	Screwdriver for grub screws with plastic handle, blade made from chrome vanadium, nickel-plated, 80 x 2.8 mm

No. Description of individual tools

4-331	Assembly screwdriver with plastic handle, nickel-plated blade, 45 x 6 mm
4-391	Watchmaker's screwdriver , nickel-plated, with 4 interchangeable blades 1.5, 2.0, 2.5 and 3.0 mm
4-407	Screw holder , nickel-plated, blade 110 x 4 mm
5-107	Steel tweezers , with bent tips, 150 mm, nickel-plated
5-117	Steel tweezers , straight, flat and wide, 145 mm, nickel-plated
5-261	Contact file
5-301	Special sheet-metal scissors , serrated, extremely slim, 110 mm, nickel-plated
5-511	Pocket knife
7-505	Tape measure , 1 m
8-135	ERSA-soldering iron "Multitip" , 15 W, 220 V
	Wire solder

SPRINTER 3100 SERVICE CASE

The handy tool case for service-inspection of the electronics engineer



- 3100 **BERNSTEIN** SPRINTER with tool set
- 3110 **BERNSTEIN** SPRINTER with tool set but without gas solder
- 3115 **BERNSTEIN** SPRINTER without tool set

Description:

Elegant black grained leather case with all-round zip fastener and red plastic lining. The set comprises 19 BERNSTEIN tools for service work. The BERNSTEIN Sprinter has a handy size for the pocket of the smock.

Outside dimensions: 205 x 120 x 50 mm (when closed)

Weight with tools: approx. 0.750 kg

Tool set:

No.	Description of individual tools
1-151	Adjusting screwdriver , blade 40 x 3 mm
1-305	Adjusting screwdriver , blade 80 x 2.4 mm with bronze insert 1.1 x 0.5 mm
1-307	Adjusting screwdriver , blade 80 x 2.4 mm, with bronze tip 2.0 x 0.5 mm
2-127	Tin knife with plastic handle, 115 mm
2-166	Contact-cleaner , made from glass fibre
2-265-1	Test prod , red, especially thin, pointed and flexible, blade made from 1 mm steel wire
2-265-2	Test prod , black, especially thin, pointed and flexible, blade made from 1 mm steel wire
2-275	Repair mirror , 21 mm Ø
3-127-2	"Slimline" side cutters , 115 mm, for soft wire up to 1.0 mm, extremely slim head, box joint, compression spring, chrome-plated, with transparent insulation
3-445-2	Micro snipe-nose pliers , 120 mm, oval pointed design, box joint, chrome-plated, with transparent insulation

No.	Description of individual tools
4-102 S	Engineer's screwdriver , with special square pattern BERNSTEIN handle, blade made from chrome vanadium, chrome-plated, 75 x 3.5 mm
4-271	Cross-recess screwdriver , Supadriv/Pozidriv, size 0 with special square pattern BERNSTEIN handle, blade made from chrome vanadium, nickel-plated, with black tip
4-311	Screwdriver for headless screws , with plastic handle, blade made from chrome vanadium, nickel-plated, 80 x 2.8 mm
4-393	Watchmaker's screwdriver , with 5 interchangeable blades 1.5, 2.0, 2.5, cross-recess blades size 00 and 000
4-406	Screw holder , nickel-plated, blade 80 x 4 mm
5-107	Steel tweezers , with bent tips, 150 mm, nickel-plated
5-131	Watchmaker's tweezers , 110 mm, stainless, sharply-pointed
6-771	Adjustable wrench , jaw opening 0-12 mm, total length 100 mm
8-396	Gas-soldering-iron , 10 - 60 W

PROFI 5500 ELECTRICIAN'S CASE

The electrician's case thought out to the very last detail



5500 **BERNSTEIN** PROFI electrician's case with tool set

5515 **BERNSTEIN** PROFI electrician's case without tool set

Description:

Body of case made from textured ABS material, cover flaps made from best, black, grained cowhide. The locks are on the top of the case. The handle is slotted through the flap, thereby distributing the load over the entire area of the cover. Inside on the right and on the left, there are each 5 adjustable loops. A special plastic holder mounted on the back is particularly suitable for holding screwdrivers, chisels etc. The 7 compartments sewn into the cover of the case are used for holding pliers. The set comprises 33 tools. The bottom of the case acts as a tray. There is plenty of room for a drill and sundry accessories.

Outside dimensions: 430 x 340 x 190 mm

Weight without tools: 2.000 kg

Weight with tools: 6.100 kg

Tool set:

No.	Description of individual tools	No.	Description of individual tools
3-133-1	Side cutters , 145 mm, for hard wire, chrome-plated, with BERNSTEINIT insulation	5-271	Workshop file , 200 mm, flat and blunt, with wooden handle
3-235-1	Telephone pliers , 145 mm, chrome-plated, with BERNSTEINIT insulation	5-274	Workshop file , 200 mm, half-round, with wooden handle
3-522-1	Round pliers , 145 mm, chrome-plated with BERNSTEINIT insulation	5-309	Cable-stripping scissors , 190 mm, stainless, with plastic handles
3-575-6	Water pump pliers , 240 mm, nickel-plated, with insulation	5-501	Cable knife
3-733-1	Combination pliers , 180 mm, chrome-plated, with BERNSTEINIT insulation	7-116	Engineer's hammer , 300 g
3-815-1	Wire strippers , 155 mm, chrome-plated, with BERNSTEINIT insulation	7-202	Firmer chisel , blade width 16 mm
4-103 S	Engineer's screwdriver with special square BERNSTEIN handle blade made from chrome vanadium, chrome-plated, 100 x 4 mm	7-235	Flat chisel , chrome vanadium, 200 x 16 x 20 mm
4-104 S	Engineer's screwdriver as above, blade 150 x 5 mm	7-255	Electrician's chisel , chrome vanadium, 200 x 8 x 10 mm
4-105 S	Engineer's screwdriver as above, blade 200 x 6 mm	7-303	Twist gimlet , 3 mm Ø
4-135 S	Engineer's screwdriver as above, blade 150 x 8 mm	7-315	Drill rasp , with plastic handle, blade 175 x 4 mm Ø
4-252	Cross-recess screwdriver with plastic handle, blade made from chrome vanadium, nickel-plated, size 1	7-316	Punch , with plastic handle, 6 mm Ø
4-253	Cross-recess screwdriver as above, size 2	7-405	Trowel , with wooden handle, blade width 50 mm
4-311	Screwdriver for grub screws with plastic handle, blade made from chrome vanadium, nickel-plated, 80 x 2.8 mm	7-410	Slicker trowel , with round shank, blade width 16 mm
4-344 VDE	Voltage tester , blade 100 x 3.5 mm	7-415	Rubber beaker for plaster , round
4-351	Offset screwdriver , C.V., nickel-plated, 100 x 5 mm	7-425	Dust brush
		7-502	Folding rule , 2 m
		7-535	Spirit level , 220 mm, with 3 levels: horizontal, vertical and 45° angle
		7-615	Pocket hack saw "Puk" with fixed wooden handle and saw blade

MULTI 5600 ELECTRICIAN'S CASE

The handy, spacious electrician's tool case



5600 **BERNSTEIN** MULTI with tool set

5615 **BERNSTEIN** MULTI without tool set

Description:

Stable case, body made from textured ABS material, side and cover flaps made from best, black, grained cowhide. The handle is slotted through the flap, thereby distributing the load over the entire area of the cover. When opening, the side flaps are held by bands. This enables the user to survey all the tools easily.

37 tools are held by compartments, adjustable loops and a special holder. The bottom of the case is a plastic tray which may carry additional tools. The case has 2 locks.

Outside dimensions: 430 x 340 x 195 mm

Weight without tools: approx. 2.900 kg

Weight with tools: approx. 6.900 kg

Tool set:

No.	Description of individual tools	No.	Description of individual tools
3-133-1	Side cutters , 145 mm, for hard wire, chrome-plated with BERNSTEINIT insulation	5-271	Workshop file , 200 mm, flat and blunt, with wooden handle
3-235-1	Telephone pliers , 145 mm, chrome-plated, with BERNSTEINIT insulation	5-274	Workshop file , 200 mm, half-round, with wooden handle
3-575-6	Water pump pliers , 240 mm, nickel-plated, with insulation	5-309	Cable-stripping scissors , 190 mm, stainless, with plastic handles
3-732-1	Combination pliers , 160 mm, chrome-plated, with BERNSTEINIT insulation	5-501	Cable knife
3-815-1	Wire strippers , 155 mm, chrome-plated, with BERNSTEINIT insulation	5-505	Wire-stripping knife for cable 8-28 mm Ø
4-125 S	Engineer's screwdriver with special square BERNSTEIN handle, blade made from chrome vanadium, chrome-plated, 100 x 6 mm	6-820	8-pieces set offset hexagon key wrenches , 1.5 to 6 mm A/F, in plastic case
4-135 S	Engineer's screwdriver as above, blade 150 x 8 mm	7-116	Engineer's hammer , 300 g
4-311	Screwdriver for grub screws with plastic handle, blade made from chrome vanadium, nickel-plated, 80 x 2.8 mm	7-202	Firmer chisel , blade width 16 mm
4-344 VDE	Voltage tester , blade 100 x 3.5 mm	7-235	Flat chisel , chrome vanadium, 200 x 16 x 20 mm
14-603 VDE	Insulated screwdriver , blade 100 x 4.0 mm	7-255	Electrician's chisel , chrome vanadium, 200 x 8 x 10 mm
14-604 VDE	Insulated screwdriver as above, blade 125 x 5.5 mm	7-303	Twist gimlet , 3 mm Ø
14-606 VDE	Insulated screwdriver as above, blade 150 x 6.5 mm	7-306	Twist gimlet , 6 mm Ø
14-632 VDE	Insulated cross-recess screwdriver , size 1	7-316	Punch , with plastic handle, 6 mm Ø
14-633 VDE	Insulated cross-recess screwdriver as above, size 2	7-405	Trowel , with wooden handle, blade width 50 mm
5-107-6	Steel tweezers with fine, bent tips, 150 mm, nickel-plated, strong PVC-insulated	7-410	Slicker trowel , with round shank, blade width 16 mm
5-117-6	Steel tweezers , straight, flat and wide, 145 mm, nickel-plated, strong PVC-insulated	7-415	Rubber beaker for plaster , round
		7-502	Folding rule , 2 m
		7-535	Spirit level , 220 mm, with 3 levels: horizontal, vertical and 45° angle
		7-616	Pocket hack saw "Puk" with adjustable wooden handle, saw blade and plastic wallet

To complete the set we recommend:

- 8-145 **ERSA soldering iron**, 30 W, 220 V
- 8-403 **Soldering wire**, 250 g spool, 1.5 mm Ø

JUMBO HOUSEHOLD ELECTRONICS SERVICE CASE

The universal case with tools for the installation of domestic appliances and fittings, with VDE-tools for the electrical installation inside the house, with special tools for the repair of domestic appliances as well as bearings in washing machines and dryers. A complete case for the electrician in household electronics.

5700 **BERNSTEIN JUMBO** with tool set

5715 **BERNSTEIN JUMBO** without tool set

Description

The case is made from deep-drawn plastic shells with a sturdy aluminium frame and replaceable protective rubber edges. In the lid of the case is a pocket for documents with different divisions. 43 tools are clearly arranged in pockets on 2 tool trays and in the plastic tray with adjustable partitions in the bottom of the case.

The tool trays are fixed to the case with a special clip system.

The case is locked by a central safety code.

Outside dimensions: 480 x 350 x 210 mm

Weight without tools: approx. 6.340 kg

Weight with tools: approx. 12.000 kg

Tool set:

No.	Description of individual tools	No.	Description of individual tools
3-575-6	Water pump pliers, 240 mm, nickel-plated, with red insulation	14-602 VDE	Safety insulated screwdriver, VDE-insulation, blade 100 x 3.5 mm
3-578-6	Siphon water pump pliers, 240 mm, with 4 adjustments, nickel-plated, with red insulation, opening up to 70 mm	14-604 VDE	Safety insulated screwdriver, VDE-insulation, blade 125 x 5.5 mm
4-950	Interchangeable screwdriver set, TORX / TRI WING, 11-piece set, in a wallet, chrome vanadium, TW 1, TW 2, TW 3, TW 4, T 10, T 15, T 20, T25, T 27, T 30 and interchangeable handle	14-606 VDE	Safety insulated screwdriver, VDE-insulation, blade 150 x 6.5 mm
5-309	Cable stripping shears 190 mm, stainless, with plastic handles	14-632 VDE	Cross-recess screwdriver, size 1, with VDE safety insulation, blade length 80 mm
5-505	Insulation stripping tool for cable diameter of 8 up to 28 mm	14-633 VDE	Cross-recess screwdriver, size 2, with VDE safety insulation, blade length 100 mm
6-781	Fitting wrench, with protection jaws, 270 mm, jaw opening 55 mm, jaw length 47 mm, for chrome plated fittings	15-522 VDE	Cable stripping knife, with protection for the blade, blade length 35 mm
7-116	Engineer's hammer, 300 g	16-505 VDE	Single-ended open-jaw wrench with two-colour multilayered safety insulation, 10 mm A/F
7-235	Flat chisel, chrome vanadium, 200 x 16 x 20 mm	16-506 VDE	Single-ended open-jaw wrench with two-colour multilayered safety insulation, 11 mm A/F
7-255	Electrician's chisel, chrome vanadium, 200 x 8 x 10 mm	16-507 VDE	Single-ended open-jaw wrench, with two-colour multilayered safety insulation, 12 mm A/F
7-316	Punch with impact-resistant plastic handle, blade 6 mm Ø	16-508 VDE	Single-ended open-jaw wrench, with two-colour multilayered safety insulation, 13 mm A/F
7-410	Slicker trowel with round shank, blade width 16 mm	16-509 VDE	Single-ended open-jaw wrench, with two-colour multilayered safety insulation, 14 mm A/F
7-502	Folding rule, 2 m	16-512 VDE	Single-ended open-jaw wrench, with two-colour multilayered safety insulation, 17 mm A/F
7-616	Pocket saw, with adjustable wooden handle, in a wallet	16-513 VDE	Single-ended open-jaw wrench, with two-colour multilayered safety insulation, 19 mm A/F
13-106 VDE	Side cutters, 160 mm, for steel wire up to 1.6 mm Ø, chrome-plated, with two- colour multilayered safety insulation	03-0055	Pipe Cutter, 210 mm, for cutting of composite pipes with a diameter of 12 - 20 mm and protective pipes with a diameter of 18 - 35 mm
13-207 VDE	Telephone pliers, 205 mm, snipe nose, long, straight jaws, chrome-plated, with two- colour multilayered safety insulation	03-0051	Pliers wrench, 180 mm, jaw opening up to 35 mm, for gripping, holding, pressing and bending of workpieces
13-707 VDE	Combination pliers, 190 mm, chrome-plated, with two-colour multilayered safety insulation	03-0052	Pliers wrench, 250 mm, jaw opening up to 35 mm, for gripping, holding, pressing and bending of workpieces
13-806 VDE	Wire strippers, 165 mm, chrome-plated, with two-colour multilayered safety insulation		

To complete the set we recommend:

7-032	Mechanical 2-arm puller, clamping capacity 15 - 85 mm, length of jaws 85 mm
7-033	Mechanical 2-arm puller, clamping capacity 20 - 150 mm, length of jaws 80 mm
7-036	Mechanical 3-arm puller, clamping capacity 15 - 85 mm, length of jaws 85 mm
7-037	Mechanical 3-arm puller, clamping capacity 20 - 150 mm, length of jaws 80 mm
16-440 VDE	Sockets, 9-piece set, in a wallet, sockets and T-bar with two-colour multilayered insulation, 10.0, 11.0, 12.0, 13.0, 14.0, 15.0, 17.0, 19.0 mm A/F
17-531 VDE	Voltage tester „Steinel Volt Check 3“

JUMBO 5700 HOUSEHOLD ELECTRONICS SERVICE CASE

The universal case for outdoor-service in household electronics



PC-CONTACT ELECTRONIC SERVICE CASE

The clearly arranged tool case for the prompt and efficient servicing of computers

6100 **BERNSTEIN** PC-CONTACT with tool set

6115 **BERNSTEIN** PC-CONTACT without tool set

Description:

Elegant, hard-wearing case made from deep-drawn, impact-resistant, grained dark brown plastic with a continuous bronze anodised aluminium frame, dustproof and rainproof, acid-resistant, scratch-resistant and non-slip.

65 tools are clearly arranged in pockets on one swiveling and one removable tray.

The back of the panel has elastic loops to take documents, discs, pcb's, measuring instruments etc.

The lid of the case is padded with foam rubber. The split plastic tray in the bottom of the case, which is intended to take spare parts, measuring instruments and soldering equipment, is 60 mm high.

The case has a lock strip with 2 locks and is centrally lockable. It has loops at the sides for attaching a carrying strap.

Outside dimensions: 460 x 350 x 170 mm

Weight without tools: approx. 3.700 kg

Weight with tools: approx. 5.400 kg

Tool set:

No.	Description of individual tools	No.	Description of individual tools
2-127	Tin knife , with plastic handle, 115 mm	4-272	Cross-recess screwdriver , Supadriv/Pozidriv as above, size 1
2-132	Spring hook , nickel-plated and insulated, 175 mm	4-281	Electronics cross-recess screwdriver with special black handle and swivel top, size 000, blade chrome vanadium, chrome-plated, with black tip
2-161	Magnetic bar with double ball- and socket joint, slewable, 215 mm	4-282	Electronics cross-recess screwdriver as above, size 00
2-166	Contact cleaner , made from glass fibre, 115 mm	4-283	Electronics cross-recess screwdriver as above, size 0
2-265	2 Test prods , red and black, extremely slim, pointed and flexible, blade made from 1 mm steel wire, 155 mm	4-284	Electronics cross-recess screwdriver as above, size 1
2-601	IC tweezers , nickel-plated, 125 mm, for gripping, inserting and removing IC's	4-335	Screwdriver for special screws on cabinets
2-620	PLCC extractor for easy removal of plug-in PLCC's	4-343 VDE	Voltage tester , blade 60 x 3 mm
2-275	Repair mirror , 21 mm Ø, with handle, 180 mm long	4-407	Retaining screwdriver , 110 x 4 mm
3-901-12	Side cutters , 120 mm, for hard wire up to 0.4 mm, for soft wire up to 1.0 mm, burnished, with orange insulation	5-107	Engineer's tweezers , made from steel, with bent tips, 150 mm
3-906-12	End cutters , 120 mm, for soft wire up to 0.8 mm, burnished, with orange insulation	5-117	Engineer's tweezers , straight-flat-wide, 145 mm, nickel-plated
3-932-12	Flat nose pliers , 120 mm, burnished, with orange insulation	5-210	Needle files , 6-piece set
3-933-12	Snipe nose pliers , 120 mm, burnished, with orange insulation	5-305	Combination scissors , stainless, serrated, compression spring, plastic handles, 140 mm
3-945-12	Snipe nose pliers , 145 mm, angular long jaws, burnished with orange insulation	6-190	Socket spanner set , 8 pieces, in plastic case, 1 plastic handle, 7 socket spanners 1/8", 5/32", 3/16", 7/32", 1/4", 5/16", 3/8"
4-102 S	Engineer's screwdriver with special square BERNSTEIN handle, blade made from chrome vanadium, chrome-plated, 75 x 3.5 mm	6-750	Special open-end wrenches , 6-piece set, nickel-plated, 3 x 3.5, 4 x 4.5, 5 x 5.5, 6 x 6.5, 7 x 8, 9 x 10 mm, material thickness 1.5 resp. 2.0 mm
4-103 S	Engineer's screwdriver as above, blade 100 x 4 mm	6-771	Adjustable wrench , jaw opening 0 - 12 mm, total length 100 mm
4-161	Electronics screwdriver with special handle and swivel top, blade chrome vanadium, chrome-plated, with black tip, blade 40 x 1.0 mm	6-880	Set of wrench keys , 8 pieces in plastic case, 1/16", 5/64", 3/32", 1/8", 5/32", 3/16", 7/32", 1/4"
4-162	Electronics screwdriver as above, blade 40 x 1.5 mm	6-964 L	TORX screwdriver with special square BERNSTEIN handle, blade made from chrome vanadium, chrome-plated, black tip, size T 9 with hole
4-163	Electronics screwdriver as above, blade 40 x 2.0 mm	6-965 L	TORX screwdriver as above, size T 10 with hole
4-165	Electronics screwdriver as above, blade 50 x 3.0 mm	6-966 L	TORX screwdriver as above, size T 15 with hole
4-271	Cross-recess screwdriver , Supadriv/Pozidriv, Size 0, with special square pattern BERNSTEIN handle, blade made from chrome vanadium, chrome-plated, with black tip	7-425	Dust brush

To complete the set we recommend:

8-135	ERSA "Multitip" soldering iron , 15 W, 220 V
8-390	Desoldering pump , length 195 mm, 20 mm Ø
8-407	Soldering wire coil , 250 g, 0.8 mm Ø
8-413	SPIRIG desoldering wire 1.5 mm x 1.5 m
9-325	Plastic box , with hinged lid and adjustable compartments, 200 x 130 x 30 mm

PC-CONTACT 6100 ELECTRONIC SERVICE CASE

Elegant, modern tool case for the most exacting standards



The service case

for the computer technology
with the current tool assortment

ELECTRONIC SERVICE CASE DATA

The handy tool case for quick service in data systems engineering

6300 **BERNSTEIN** DATA with tool set

6315 **BERNSTEIN** DATA without tool set

Description:

Case made from deep-drawn, grained plastic, with a black aluminium frame, rainproof, impact-, acid- and scratch-resistant. The 34 tools are placed at hand on a pivoting tool tray. The lid of the case has a pocket for documents. In the bottom is a plastic-tray with adjustable partitions for measuring instruments, soldering tools and components to the height of 60 mm. The case has 2 locks.

Outside dimensions: 460 x 310 x 120 mm

Weight without tools: approx. 3.800 kg

Weight with tools: approx. 4.700 kg

Tool set:

No.	Description of individual tools	No.	Description of individual tools
1-909	Engineer's mirror , with handle, made entirely from BERNSTEINIT	4-271	Cross-recess screwdriver , Supadriv/Pozidriv, size 0 with special square pattern BERNSTEIN handle, blade made from chrome vanadium, nickel-plated, with black tip
2-127	Tin knife , with plastic handle, 115 mm	4-272	Cross-recess screwdriver , Supadriv/Pozidriv, size 1, with special square pattern BERNSTEIN handle, blade made from chrome vanadium, nickel-plated, with black tip
2-132	Spring hook , nickel-plated and insulated, 175 mm	4-311	Screwdriver for headless screws , with plastic handle, blade made from chrome vanadium, nickel-plated, 80 x 2.8 mm
2-166	Contact cleaner , made from glass fibre, 115 mm	4-343 VDE	Voltage tester , blade 60 x 3 mm
2-265-1	Test prod , black, especially thin, pointed and flexible, blade made from 1 mm steel wire, 155 mm	4-366	Cross-recess watchmaker's screwdriver , size 00
2-265-2	Test prod , black, especially thin, pointed and flexible, blade made from 1 mm steel wire, 155 mm	4-391	Watchmaker's screwdriver , nickel-plated, with 4 interchangeable blades, 1.5, 2.0, 2.5, 3.0 mm
2-291	Plastic magnifying glass	5-107	Engineer's tweezers , made from steel, with bent tips, 150 mm, nickel-plated
2-601	IC tweezers , nickel-plated, 125 mm, for gripping, inserting and removing IC's	5-117	Engineer's tweezers , made from steel, straight-flat-wide, 145 mm, nickel-plated
3-127-2	"Slimline" side cutters , 115 mm, for soft wire up to 1,0 mm, extremely slim head, box joint, compression spring, chrome-plated, with transparent insulation	5-121	Engineer's tweezers , made from steel, straight, with narrow pointed tips, 120 mm, nickel-plated
3-131-1	Side cutters , 120 mm, chrome-plated, for hard wire up to 0.8 mm, for soft wire up to 1.5 mm, with BERNSTEINIT insulation	5-301	Special scissors for cutting sheet-metal and wires, with serration, extremely slim, 110 mm, nickel-plated
3-455-2	Micro pointed pliers , 120 mm, extremely light and slim, box joint, chrome-plated, with transparent insulation	6-820	Set of allen hex sockets , 8 pieces, in plastic wallet, 1.5, 2.0, 2.5, 3.0, 4.0, 5.0, 5.5, 6.0, mm
4-102 S	Engineer's screwdriver with special square BERNSTEIN handle, blade made from chrome vanadium, chrome-plated, 75 x 3.5 mm	6-771	Adjustable wrench , jaw opening 0-12 mm, total length 100 mm
4-103-1 S	Engineer's screwdriver , with special square pattern BERNSTEIN handle, insulated blade, made from chrom vanadium, chrome-plated 100 x 4 mm	7-505	Roller tape measure , 1 m
		7-512	Miniature caliper square , stainless, measuring range 100 mm

To complete the set we recommend:

- 9-325 **Plastic box** with hinged lid and adjustable compartments, 200 x 130 x 30 mm
- 8-390 **Desoldering pump**, length 195 mm, 20 mm Ø
- 8-135 **ERSA "Multitip" soldering iron**, 15 W, 220 V

DATA 6300 ELECTRONIC SERVICE CASE

The practical assistant for the successful data systems engineer



TECHNIK ELECTRONIC SERVICE CASE

Service case with a comprehensive tool kit for data systems engineering

- 6400 **BERNSTEIN** **TECHNIK** with tool set
- 6415 **BERNSTEIN** **TECHNIK** without tool set
- 6400 Z **BERNSTEIN** **TECHNIK** with central safety code and tool set
- 6415 Z **BERNSTEIN** **TECHNIK** with central safety code without tool set

Description:

Case made from deep-drawn, impact-resistant, grained plastic, with a sturdy aluminium frame, dustproof and rainproof, acid- and scratch-resistant. Three removable trays with pockets hold 82 tools, one tray has a double pocket on the back for documents. In the bottom of the case is a plastic tray, 60 mm high, with adjustable partitions for measuring instruments, soldering iron and various accessories. The case has 2 locks.

Outside dimensions: 470 x 360 x 180 mm

Weight without tools: approx. 4.700 kg

Weight with tools: approx. 7.600 kg

Tool set:

No.	Description of individual tools	No.	Description of individual tools
1-909	Engineer's mirror , with handle, made entirely from BERNSTEINIT	4-311	Screwdriver for headless screws , with plastic handle, blade made from chrome vanadium, nickel-plated, 80 x 2.8 mm
2-126	Desoldering lever , slotted at one end, with plastic handle	4-321	Chubby screwdriver , 25 x 4.5 mm
2-127	Tin knife , with plastic handle, 115 mm	4-343 VDE	Voltage tester , blade 60 x 3 mm
2-128	Tin scraper , with plastic handle, 115 mm	4-351	Offset screwdriver , chrome vanadium, nickel-plated, 100 x 5 mm
2-132	Spring hook , nickel-plated and insulated, 175 mm	4-366	Cross-recess watchmaker's screwdriver , size 00
2-145	Screwdriver with guide sleeve for slotted axles up to 3.2 mm Ø	4-391	Watchmaker's screwdriver , nickel-plated, with 4 interchangeable blades, 1.5, 2.0, 2.5, 3.0 mm
2-161	Magnetic bar with double ball- and socket joint, slewable, 215 mm	4-407	Retaining screwdriver , 110 x 4 mm
2-265	2 Test prods , red and black, extremely slim, pointed and flexible, blade made from 1 mm steel wire	5-006	Component tweezers , nickel-plated, with insulated jaws, for easy insertion and removal of plug-in transistors of various sizes
2-601	IC tweezers , nickel-plated, 125 mm, for gripping, inserting and removing IC's	5-107	Engineer's tweezers , made from steel, with bent tips, 150 mm, nickel-plated
3-127-2	"Slimline" side cutters , 115 mm, for soft wire only up to 1.0 mm, extremely slim head, box joint, compression spring, chrome-plated, with transparent insulation	5-115	Heat dissipating tweezers , 165 mm, nickel-plated, for use when soldering transistors, gold-bonded diodes etc.
3-131-1	Side cutters , 120 mm, chrome-plated, for hard wire up to 0.8 mm, for soft wire up to 1.5 mm, with BERNSTEINIT insulation	5-117	Engineer's tweezers , straight-flat-wide, 145 mm, nickel-plated
3-461-2	Round nose pliers , 130 mm, slim, box joint, compression spring, chrome-plated, with transparent insulation	5-131	Watchmaker's tweezers , 110 mm, stainless, sharply-pointed
3-462-2	Flat nose pliers , 130 mm, slim, box joint, compression spring, chrome-plated, with transparent insulation	5-161	Clamping scissors , 130 mm, stainless
3-481-2	Snipe nose pliers , 120 mm, angular, box joint, compression spring, chrome-plated, with transparent insulation	5-181	Wire scraper , for wires 0.6 mm Ø, interchangeable cutters
3-565	Miniature water pump pliers , 120 mm, chrome-plated	5-210	Needle files , 6-piece set
3-732-1	Combination pliers , 160 mm, chrome-plated, with BERNSTEINIT insulation	5-301	Special scissors for cutting sheet-metal and wires, with serration, extremely slim, 110 mm, nickel-plated
3-761-10	Special assembly pliers for clamping rings, 1.5 mm – 2.8 mm, 140 mm, burnished, with adjusting screw	5-501	Cable knife
3-835-2	Wire strippers , 165 mm, narrow and slim, with adjusting screw and compression spring, chrome-plated, with transparent insulation	6-200	Socket spanner set , chrome vanadium, nickel-plated, 1 plastic handle, 7 socket spanners, 4.0, 5.5, 6.0, 7.0, 8.0, 9.0, 10.0 mm
4-102-1 S	Engineer's screwdriver , with special square pattern BERNSTEIN handle, insulated blade, made from chrome vanadium, chrome-plated, 75 x 3.5 mm	6-750	Special open-end wrenches , 6-piece set, nickel-plated, material thickness 1.5 or 2 mm, 3 x 3.5, 4 x 4.5, 5 x 5.5, 6 x 6.5, 7 x 8, 9 x 10 mm
4-103-1 S	Engineer's screwdriver , as above, blade 100 x 4 mm	6-820	Set of allen hex sockets , 8 pieces, in plastic wallet, 1.5, 2.0, 2.5, 3.0, 4.0, 5.0, 5.5, 6.0, mm
4-104-1 S	Engineer's screwdriver , as above, blade 150 x 5 mm	6-860	Electronic socket spanner set , in transparent box, 6 pieces, 3.0, 3.5, 4.0, 4.5, 5.0 mm
4-261	Cross-recess screwdriver , size 01, with plastic handle, blade made from chrome vanadium, 25 mm long, nickel-plated	7-425	Dust brush
4-271	Cross-recess screwdriver , Supadriv/Pozidriv, size 0, with special square pattern BERNSTEIN handle, blade made from chrome vanadium, 60 mm long, nickel-plated, with black tip	7-428	Duster
4-272	Cross-recess screwdriver , Supadriv/Pozidriv, as above, size 1, 80 mm long	7-435	Plastic-oiler , with standpipe made from brass
4-301	Miniature screwdriver , with plastic handle, blade nickel-plated, 40 x 1.8 mm	7-508	Steel tape measure , 30 cm, stainless
		7-511	Precision caliper square , stainless, in wallet, measuring range 160 mm, 1/20 nonius, separation mm/inches
		7-616	Pocket saw , in wallet

To complete the set we recommend:

- 9-325 **Plastic box** with hinged lid and adjustable compartments, 200 x 130 x 30 mm
- 8-390 **Desoldering pump**, length 195 mm, 20 mm Ø
- 8-135 **ERSA "Multitip" soldering iron**, 15 W, 220 V

TECHNIK 6400 ELECTRONIC SERVICE CASE

A toolcase as a bordcase for the travelling engineer



The service case

- for the computer technology
- with special tool assortment
- for the professional

Service case **Technik 6400 Z**
with central safety code



BOSS ELECTRONIC SERVICE CASE

The actual multi-purpose tool case with the vast assortment

6500 **BERNSTEIN BOSS** with tool set

6515 **BERNSTEIN BOSS** without tool set

Description:

Body of case made from deep-drawn, impact-resistant, grained black plastic, with a sturdy aluminium frame, dustproof and rainproof, acid- and scratch-resistant.

The 105-piece tool set comprises all required conventional and special tools for the servicing of electronic equipment, also for difficult repairs. The tools are clearly arranged in partitions on tool trays which are removable and folding and the swiveling parts are securable:
A variable tool chest in case-size!

A stable plastic tray, 90 mm high, with 6 partition walls for a variable arrangement of the divisions offers a lot of space to carry spare parts, measuring instruments and soldering irons. The lid of the case has a pocket for documents. The case has 2 locks.

Outside dimensions: 490 x 410 x 190 mm

Weight without tools: approx. 6.500 kg

Weight with tools: approx. 10.600 kg

Tool set:

No.	Description of individual tools	No.	Description of individual tools
1-151	Adjusting screwdriver , blade 40 x 3 mm	4-281	Electronics cross-recess screwdriver with special grey handle and swivel top, blade chrome vanadium, chrome-plated, with black tip, 40 x 2.0 mm, size 000
1-153	Adjusting screwdriver , blade 130 x 2 mm	4-282	Electronics cross-recess screwdriver as above size 00
1-155	Adjusting screwdriver , blade 130 x 3.5 mm	4-283	Electronics cross-recess screwdriver as above, blade 50 x 3.0 mm, size 0
1-909	Engineer's mirror , with handle, made entirely from BERNSTEINIT	4-343 VDE	Voltage tester , blade 60 x 3 mm
2-126	Desoldering lever , slotted at one end, with plastic handle	4-351	Offset screwdriver , chrome vanadium, nickel-plated, 100 x 5 mm
2-127	Tin knife with plastic handle, 115 mm	4-391	Watchmaker's screwdriver , nickel-plated, with 4 interchangeable blades, 1.5, 2.0, 2.5, 3.0 mm
2-128	Tin scraper with plastic handle, 115 mm	4-407	Retaining screwdriver , 110 x 4 mm
2-132	Spring hook , nickel-plated and insulated, 175 mm	5-006	Component tweezers , nickel-plated, with insulated jaws, for easy insertion and removal of plug-in transistors of various sizes
2-152	Tool holder , nickel-plated brass, with collets at both ends for holding tools from 0 to 3 mm Ø	5-107	Engineer's tweezers made from steel, with bent tips, 150 mm, nickel-plated
2-155	Claw-type gripper , nickel-plated brass, with 4 wire claws, small version with clip	5-107-6	Engineer's tweezers , as above, strong PVC-insulated
2-161	Magnetic bar with double ball- and socket joint, slewable, 215 mm	5-115	Heat dissipating tweezers , 165 mm, nickel-plated, for use when soldering transistors, gold-bonded diodes etc.
2-166	Contact cleaner , made from glass fibre	5-117	Engineer's tweezers , straight-flat-wide, 145 mm, nickel-plated
2-265	2 Test prods , red and black, extremely slim, pointed and flexible, blade made from 1 mm steel wire	5-131	Watchmaker's tweezers , 110 mm, stainless, sharply-pointed
2-295	Hand magnifier with light	5-161	Clamping scissors , 130 mm, stainless
2-601	IC tweezers , nickel-plated, 125 mm, for gripping, inserting and removing IC's	5-181	Wire scraper , for wires 0.6 mm Ø, interchangeable cutter
2-620	PLCC extractor , for easy removal of plug-in PLCC'S	5-191	ESD/EGB tweezers , 120 mm, conductive, with straight, rounded tips
3-127-2	"Slimline" side cutters , 115 mm, for soft wire up to 1.0 mm, extremely slim head, box joint, compression spring, chrome-plated, with transparent insulation	5-194	ESD/EGB tweezers , 120 mm, conductive, with bent, pointed tips
3-132-1	Side cutters , 130 mm, for hard wire, chrome-plated, with BERNSTEINIT-insulation	5-210	Needle files , 6-piece set
3-235-1	Telephone pliers with wire cutters, 145 mm, chrome-plated with BERNSTEINIT-insulation	5-301	Special scissors , for cutting sheet-metal and wires, with serration, extremely slim, 110 mm, nickel-plated
3-462-2	Flat nose pliers , 130 mm, slim, box joint, compression spring, chrome-plated, with transparent insulation	5-305	Combination scissors , stainless, serrated, compression spring, plastic handles, 140 mm
3-463-2	Snipe nose pliers , 130 mm, slim, box joint, compression spring, chrome-plated, with transparent insulation	5-501	Electrician knife
3-482-2	Snipe nose pliers , 140 mm, angular, slim, box joint, compression spring, chrome-plated, with transparent insulation	6-200	Socket spanner set , chrome vanadium, nickel-plated, 8-piece set, 1 plastic handle, 7 socket spanners, 4.0, 5.5, 6.0, 7.0, 8.0, 9.0, 10.0 mm
3-565	Water pump pliers , 120 mm, chrome-plated	6-750	Special open-end wrench , 6-piece set, nickel-plated, 3 x 3.5, 4 x 4.5, 5 x 5.5, 6 x 6.5, 7 x 8, 9 x 10 mm, material thickness 1.5 or 2.0 mm,
3-742-1	Electrician's combination pliers , 160 mm, chrome-plated, with BERNSTEINIT-insulation	6-771	Adjustable wrench , jaw opening 0 - 12 mm, total length 100 mm
3-761-10	Special assembly pliers for clamping rings, 1.5 mm - 2.8 mm, 140 mm, burnished, with adjusting screw	6-830	Set of wrench keys , 11 pieces in plastic case, 1 handle, 10 wrench keys 1.0, 1.2, 1.5, 2.0, 2.5, 3.0, 4.0, 4.5, 5.0 and 6.0 mm
3-815-1	Wire strippers , 155 mm, chrome-plated, with BERNSTEINIT-insulation	6-880	Set of wrench keys , 8 pieces in plastic wallet, 1/16", 5/64", 3/32", 1/8", 5/32", 3/16", 7/32", 1/4"
3-0856	Crimp tool for insulated and uninsulated terminals, 230 mm	6-964 L	TORX screwdriver , with special square BERNSTEIN handle, blade made from chrome vanadium, chrome-plated, black tip, size T 9 with hole
3-871-6	Pressing pliers for multicore cable and for sleeves from 0.25 - 2.5 mm ²	6-965 L	TORX screwdriver as above, size T 10 with hole
4-103 S	Engineer's screwdriver with special square BERNSTEIN handle, blade made from chrome vanadium, chrome-plated, 100 x 4 mm	6-966 L	TORX screwdriver as above, size T 15 with hole
4-104 S	Engineer's screwdriver as above, blade 150 x 5 mm	7-425	Dust brush
4-161	Electronics screwdriver with special handle and swivel top, blade chrome vanadium, chrome-plated, with black tip, blade 40 x 1.0 mm	7-428	Duster
4-162	Electronics screwdriver as above, blade 40 x 1.5 mm	7-438	Drip oiler for dropet oiling
4-164	Electronics screwdriver as above, blade 50 x 2.5 mm	7-506	Roller tape measure 2 m
4-165	Electronics screwdriver as above, blade 50 x 3.0 mm	7-508	Steel measure , 30 mm, stainless
4-272	Crosspoint-screwdriver , Supadriv/Pozidriv, size 1, with special square pattern BERNSTEIN handle, blade made from chrome vanadium, nickel-plated, with black tip	7-511	Precision caliper square , stainless, in wallet, measuring range 160 mm, 1/20 nonius, separation mm/inches
		7-616	Pocket hack saw "Puk" with adjustable wooden handle, in wallet

To complete the set we recommend:

8-135	ERSA "Multitip" soldering iron , 15 W/220 V
8-390	Desoldering pump , length 195 mm, 20 mm Ø
8-402	Soldering wire coil , 100 g, 1.5 mm Ø
9-325	Plastic box , with hinged lid and adjustable compartments, 200 x 130 x 30 mm

BOSS 6500 ELECTRONIC SERVICE CASE

A variable tool chest in case size



TELECOM ELECTRONIC SERVICE CASE

The actual case with special tools and testing instruments for the installation and maintenance of complex telecommunication systems

6600 **BERNSTEIN TELECOM** with tool set

6615 **BERNSTEIN TELECOM** without tool set

Description:

Case made from deep-drawn, impact-resistant, grained black plastic, with a sturdy aluminium frame, dustproof and rainproof, acid- and scratch-resistant. With 118 tools the case contains a complete equipment of tools especially for the electrical and electronical connecting and maintenance operations at distribution boards in the telecommunication technique.

The tools are clearly arranged in the case on 3 removable tool trays and in a stable plastic tray in the bottom of the case that grants by adjustable partitions additional place for further instruments.

The case has 2 locks.

Outside dimensions: 490 x 410 x 190 mm

Weight without tools: approx. 5.800 kg

Weight with tools: approx. 12.900 kg

Tool set

No.	Description of individual tools	No.	Description of individual tools
2-265	2 test prods, red and black, extremely slim, pointed and flexible, blade made from 1 mm steel wire	4-407	Retaining screwdriver, for inserting slotted screws, nickel-plated, blade 110 x 4.0 mm
2-275	Repair mirror, stainless, magnifying, concave mirror 21 mm Ø, with BERNSTEINIT handle	4-437	Retaining screwdriver for inserting and tightening cross-recess screws size 1, nickel-plated, insulated, blade length 150 mm
2-601	IC-tweezers, nickel-plated, 125 mm, for gripping, inserting and removing IC's	5-107	Engineer's tweezers, made from steel, with bent tips, 150 mm, nickel-plated
2-620	PLCC-extractor	5-117	Engineer's tweezers, made from steel, straight-flat-wide, 145 mm, nickel-plated
2-655	Pocket inspection lamp watertight, with pre-focused reflector	5-122	Engineer's tweezers, made from steel, straight, with narrow pointed tips, 155 mm, nickel-plated
2-701	Insertion tool with sensor for connecting the wires and simultaneously cutting off the residual wire	5-240	Warding files, 6-piece set, with wooden handles, in plastic wallet
2-702	Insertion tool for system MDF 71 for connecting the cable conductors and jumper wires	5-505	Insulation stripping tool for cable diameter of 8 up to 28 mm
2-751	Test headphones, 1 x 600 ohm, switchable from 600 to 10.000 ohm, with fine control	6-103	Socket wrench 4.5 mm, chrome vanadium, chrome-plated, with square handle
3-112-2	Side cutters, 120 mm, for soft wire up to 1.0 mm, with rounded head, double leaf spring, chrome-plated, with red insulation	6-104	Socket wrench 5.0 mm, chrome vanadium, chrome-plated, with square handle
3-134 VDE	Side cutters, 160 mm, for steel wire up to 1.6 mm Ø, chrome-plated, with VDE safety insulation	6-105	Socket wrench 5.5 mm, chrome vanadium, chrome-plated, with square handle
3-235-1	Telephon pliers, 145 mm, chrome-plated, with BERNSTEINIT-insulation	6-320	Socket wrench-set 16-piece set in a metal case, first rate quality
3-532-1	Flat nose pliers, 160 mm, with long jaws, chrome-plated, with BERNSTEINIT-insulation	6-500-12	Double open-ended wrench, 12 x 13 mm, chrome vanadium, chrome-plated
3-585-1	Quick-action water pump pliers, 175 mm, made from chrome vanadium, chrome-plated, with BERNSTEINIT-insulation	6-500-18	Double open-ended wrench, 18 x 19 mm, chrome-vanadium, chrome-plated
3-732-1	Combination pliers, 160 mm, chrome-plated, with BERNSTEINIT-insulation	6-600	Combination ring-and open-ended wrench, 7-piece set, 6.0, 7.0, 8.0, 9.0, 10.0, 11.0, 13.0 mm, chrome vanadium, chrome-plated
3-0605	Combination crimping pliers, 200 mm, for connector types 6P/6C, 6P/4C, 6P/2C, 8P/8C	6-600-12	Combination ring-and open-ended wrench, 12 mm, chrome vanadium, chrome-plated
4-141	Screwdriver with special square BERNSTEIN handle, blade made from chrome vanadium, chrome-plated, 75 x 3.5 mm, with black tip	6-600-17	Combination ring-and open-ended wrench, 17 mm, chrome vanadium, chrome plated
4-142	Screwdriver with special square BERNSTEIN handle, blade made from chrome vanadium, chrome-plated, 100 x 4.0 mm, with black tip	6-600-19	Combination ring-and open-ended wrench, 19 mm, chrome vanadium, chrome-plated
4-143	Screwdriver with special square BERNSTEIN handle, blade made from chrome vanadium, chrome-plated, 125 x 5.5 mm, with black tip	6-880	Hexagon wrench keys 8-piece set, in a wallet, 1/16", 5/64", 3/32", 1/8", 5/32", 3/16", 7/32", 1/4"
4-222	Screwdriver with special square BERNSTEIN handle, blade made from chrome vanadium, chrome-plated, 260 x 3.0 mm, with black tip	6-950	Ballpoint wrench keys, hexagon, 8-piece set, in a wallet, 1.5, 2.0, 2.5, 3.0, 4.0, 5.0, 6.0, 8.0 mm
4-227	Cross-recess screwdriver, size 1, with special square BERNSTEIN handle, blade made from chrome vanadium, chrome-plated, blade length 300 mm, with black tip	6-995	TORX-screwdrivers with bore hole in the tip 8-piece set, in a box, T 9, T 10, T 15, T 20, T 25, T 27, T 30, T 40
4-228	Cross-recess screwdriver, size 2, as above, blade length 300 mm, with black tip	7-114	Engineer's hammer, 200 g
4-255	Cross-recess screwdriver, size 0, as above, blade length 60 mm, with black tip	7-425	Duster
4-256	Cross-recess screwdriver, size 1, as above, blade length 80 mm, with black tip	7-429	Insulating tape
4-257	Cross-recess screwdriver, size 2, as above, blade length 100 mm, with black tip	7-506	Roller tape, 2 m
4-258	Cross-recess screwdriver, size 3, as above, blade length 150 mm, with black tip	7-616	Pocket saw, with adjustable wooden handle, in a wallet
4-370	Watchmaker's screwdrivers from metal, 6-piece set, in metal box, 1.0, 1.5, 2.0, 2.5, 3.0, 3.5 mm	8-110	ERSA-fine soldering iron Tip 260 BN/230 V/16 W
		8-139	Spare soldering tip 162 LN
		8-385	ERSA VAC3 desoldering pump
		8-407	Solder wire spool, 250 g, 0.8 mm Ø
		9-316/5	5 Chip-Container, conductive box with lid, black, internal dimensions: 118 x 32 x 14 mm
		14-601 VDE	Screwdriver with VDE-insulation, blade 75 x 2.5 mm
		14-602 VDE	Screwdriver with VDE-insulation, blade 100 x 3.5 mm
		14-632 VDE	Cross-recess screwdriver, size 1, with VDE-insulation, blade length 80 mm
		14-633 VDE	Cross-recess screwdriver, size 2, with VDE-insulation, blade length 100 mm
			Mini-piece

TELECOM 6600 ELECTRONIC SERVICE CASE

The professional toolcase for the telecommunication



TELEDATA ELECTRONIC SERVICE CASE

The case with a basic equipment of special tools for the installation and maintenance of complex telecommunication systems and data networks.

6700 **BERNSTEIN** TELEDATA with tool set

6715 **BERNSTEIN** TELEDATA without tool set

Description:

Case made from deep-drawn, impact-resistant, grained black plastic, with sturdy aluminium frame, dustproof and rainproof, acid- and scratch-resistant. 80 tools are clearly arranged on two removable tool trays, one of it on both sides, and in the plastic tray with adjustable partitions in the bottom of the case. The basic equipment for special operations at telecommunication systems and data networks may efficiently be completed by special tools additionally recommended.

The case has 2 locks.

Outside dimensions: 470 x 340 x 170 mm

Weight without tools: approx. 4.600 kg

Weight with tools: approx. 8.700 kg

Tool set

No.	Description of individual tools	No.	Description of individual tools
2-265	2 test prods, red and black, extremely slim, pointed and flexible, blade made from 1 mm steel wire	6-103	Socket wrench 4.5 mm, chrome vanadium, chrome-plated, with square handle
2-601	IC-tweezers, nickel-plated, 125 mm, for gripping, inserting and removing IC's	6-104	Socket wrench 5.0 mm, chrome vanadium, chrome-plated, with square handle
2-620	PLCC-extractor	6-105	Socket wrench 5.5 mm, chrome-vanadium, chrome-plated, with square handle
2-701	Insertion tool with sensor for connecting the wires and simultaneously cutting off the residual wire	6-500-12	Double open-ended wrench, 12 x 13 mm, chrome vanadium, chrome-plated
3-112-2	Side cutters, 120 mm, for soft wire up to 1.0 mm, with rounded head, double leaf spring, chrome-plated, with red insulation	6-500-18	Double open-ended wrench, 18 x 19 mm, chrome vanadium, chrome-plated
3-134 VDE	Side cutters, 160 mm, for steel wire up to 1.6 mm Ø, chrome-plated, with VDE safety insulation	6-600	Combination ring- and open-ended wrench, 7-piece set, chrome vanadium, chrome-plated, 6.0, 7.0, 8.0, 9.0, 10.0, 11.0, 13.0 mm
3-235-1	Telephone pliers, 145 mm, chrome-plated, with BERNSTEINIT-insulation	6-600-12	Combination ring- and open-ended wrench, 12 mm, chrome vanadium, chrome-plated
3-532-1	Flat nose pliers, 160 mm, with long jaws, chrome-plated, with BERNSTEINIT-insulation	6-600-17	Combination ring- and open-ended wrench, 17 mm, chrome vanadium, chrome-plated
3-585-1	Quick-action water pump pliers, 175 mm, made from chrome vanadium, chrome-plated, with BERNSTEINIT-insulation	6-600-19	Combination ring- and open-ended wrench, 19 mm, chrome vanadium, chrome-plated
3-732-1	Combination pliers, 160 mm, chrome-plated, with BERNSTEINIT-insulation	6-880	Hexagon wrench keys, 8-piece set, in a wallet, 1/16", 5/64", 3/32", 1/8", 5/32", 3/16", 7/32", 1/4"
3-0605	Combination crimping pliers, 200 mm, for connector types 6P/6C, 6P/4C, 6P/2C, 8P/8C	6-950	Ballpoint wrench keys, hexagon, 8-piece set, in a wallet, 1.5, 2.0, 2.5, 3.0, 4.0, 5.0, 6.0, 8.0 mm
4-222	Screwdriver with special square BERNSTEIN handle, blade made from chrome vanadium, chrome-plated, 260 x 3.0 mm, with black tip	6-995	Torx screwdrivers with bore-hole in the tip, 8-piece set, in a box, T 9, T 10, T 15, T 20, T 25, T 27, T 30, T 40
4-227	Crosspoint-screwdriver, size 1, with special square BERNSTEIN handle, blade made from chrome vanadium, chrome-plated, 300 mm, with black tip	7-425	Duster
4-228	Crosspoint-screwdriver, size 2, with special square BERNSTEIN handle, blade made from chrome vanadium, chrome-plated, 300 mm, with black tip	7-506	Roller tape measure, 2 m
4-431	Retaining screwdrivers for inserting and tightening slotted screws, blade made from chrome vanadium, nickel-plated, insulated, 100x3.0 mm	7-616	Pocket saw, with adjustable wooden handle, in a wallet
4-437	Retaining screwdriver for inserting and tightening cross-recess screws size 1 blade made from chrome vanadium, nickel-plated, insulated	9-316/5	5 Chip-Container, conductive box with lid, black, internal dimensions: 118 x 32 x 14 mm
5-107	Engineer's tweezers, made from steel, with bent tips, 150 mm, nickel-plated	14-601 VDE	Screwdriver with VDE-insulation, blade 75 x 2.5 mm
5-117	Engineer's tweezers, made from steel, straight-flat-wide, 145 mm, nickel-plated	14-602 VDE	Screwdriver with VDE-insulation, blade 100 x 3.5 mm
5-240	Warding files, 6-piece set, with wooden handles, in plastic wallet	14-603 VDE	Screwdriver with VDE-insulation, blade 100 x 4.0 mm
5-505	Insulation stripping tool for cable diameter of 8 up to 28 mm	14-631 VDE	Cross-recess screwdriver, size 0, with VDE-insulation, blade length 60 mm
		14-632 VDE	Cross-recess screwdriver, size 1, with VDE-insulation, blade length 80 mm
		14-633 VDE	Cross-recess screwdriver, size 2, with VDE-insulation, blade length 100 mm
		14-634 VDE	Cross-recess screwdriver, size 3, with VDE-insulation, blade length 150 mm

To complete the set we recommend:

2-751	Test headphones 1 x 600 ohm, switchable from 600 to 10.000 ohm	8-139	Spare soldering tip 162 LN
2-702	Insertion tool for systems MDF 71 for connecting the cable conductors and jumper wires	8-385	ERSA VAC3 desoldering pump
8-110	ERSA fine soldering iron Tip 260 BN/230 V/16 W	8-407	Solder wire spool, 250 g, 0.8 mm Ø

TELEDATA 6700 ELECTRONIC SERVICE CASE

The service case for the ambitious Telecommunication engineer



COMPACT-MOBIL 7000 ELECTRONIC SERVICE CASE

The trolley case as bordcase for world-wide service



The service-case

- with high quality tools for electronics
- with telescopic handle, length up to 950 mm
- mobile on installed stable rolls



COMPACT-MOBIL ELECTRICIAN'S SERVICE CASE

The multi-purpose trolley case for the assembly and maintenance of electric devices

7200 **BERNSTEIN COMPACT-MOBIL** with tool assortment 7030, 7040 and 7050

7215 **BERNSTEIN COMPACT-MOBIL** without tools

7300 **BERNSTEIN COMPACT-MOBIL** with tool assortment 7040, 7050 and 7060

Description:

as service case 7000

This tool case is also equipped with 3 removable tool trays: No. 7030, 7040 and 7050.

The trays contain all together 32 tools.

On request the tray No. 7030 may be exchanged for No. 7060 (VDE-tools).

Outside dimensions: 500 x 400 x 200 mm
(bordcase-size)

Weight without tools: approx. 7.900 kg

Weight with tools 7200: approx. 11.500 kg
Weight with tools 7300: approx. 11.600 kg

Tool set:

No. Description of individual tools

No.	Description of individual tools
Tool tray No. 7030	
3-133-1	Side cutters , 145 mm, for hard wire up to 1.25 mm Ø, for soft wire up to 2.5 mm Ø, chrome-plated, BERNSTEINIT-insulation
3-235-1	Telephone pliers , 145 mm, chrome-plated, with BERNSTEINIT-insulation
3-732-1	Combination pliers , 160 mm, chrome-plated, with BERNSTEINIT-insulation
4-103 S	Engineer's screwdriver , with special square BERNSTEIN handle, blade made from chrome vanadium, chrome-plated, 100 x 4.0 mm
4-104 S	Engineer's screwdriver , as above, blade 150 x 5.0 mm
4-135 S	Engineer's screwdriver , as above, blade 150 x 8.0 mm
4-256	Cross-recess screwdriver , as above, size 1, with black tip
4-257	Cross-recess screwdriver , as above, size 2, with black tip
4-344 VDE	Voltage tester , for 220 - 250 V, blade 100 x 3.5 mm
5-0605	Universal stripping tool
6-105	Socket wrench , with special square BERNSTEIN handle, blade made from chrome vanadium, chrome-plated, 5.5 mm A/F
6-107	Socket wrench , as above, 7.0 mm A/F
Tool tray No. 7040	
3-575-6	Water pump pliers , 240 mm, chrome-plated, with insulation
3-815-1	Wire strippers , 155 mm, chrome-plated, with BERNSTEINIT insulation
4-272	Cross-recess screwdriver Supadriv/Pozidriv, size 1, blade made from chrome vanadium, chrome-plated, with special square BERNSTEIN handle
4-273	Cross-recess screwdriver , Supadriv/Pozidriv, as above, size 2
5-304	Combination cutters , 190 mm, stainless
5-309	Cable stripping shears , 190 mm, stainless, with plastic handles
5-501	Cable knife
7-410	Slicker trowel with round shank, blade width 16 mm
7-535	Spirit level , length 225 mm, with 3 levels: horizontal, vertical and 45° angle

No. Description of individual tools

No.	Description of individual tools
Tool tray No. 7050	
5-107-6	Steel tweezers , bent, nickel-plated, safety-insulated, 150 mm
5-117-6	Steel tweezers , straight-flat-wide, safety-insulated, 145 mm
5-505	Insulation stripping tool for cable 8 - 28 mm Ø
7-114	Engineer's hammer , 200 g
7-202	Firmer chisel , blade width 16 mm
7-235	Flat chisel , 200 x 16 x 22 mm, chrome vanadium
7-255	Electrician's chisel , 200 x 8 x 10 mm, chrome vanadium
7-315	Drill rasp , bore-Ø 4 mm, length of blade 175 mm, with plastic handle
7-316	Punch , 6 mm Ø, with plastic handle
7-502	Folding rule , 2 m
7-616	Pocket saw „PUK“ in a wallet
alternatively to 7030	
Tool tray No. 7060 (VDE)	
3-134 VDE	Side cutters , 160 mm, for steel wire up to 1.6 mm Ø, chrome-plated, with VDE safety insulation
3-244 VDE	Telephone pliers , 165 mm, snipe nose, long straight jaws, with cutting edge for hard wire, chrome-plated, with VDE safety insulation
3-732 VDE	Combination pliers , 160 mm, with wire cutter, for hard wire up to 1.6 mm Ø, chrome-plated, with VDE safety insulation
4-344 VDE	Voltage tester , 220 - 250 V, blade 100 x 3.5 mm
14-602 VDE	Screwdriver , with VDE safety insulation, blade 100 x 3.5 mm
14-604 VDE	Screwdriver , with VDE safety insulation, blade 125 x 5.5 mm
14-606 VDE	Screwdriver , with VDE safety insulation, blade 150 x 6.5 mm
14-632 VDE	Cross-recess screwdriver , size 1, with VDE insulation, blade length 80 mm
14-633 VDE	Cross-recess screwdriver , size 2, with VDE insulation, blade length 100 mm
15-522 VDE	Cable stripping knife , with blade protection, blade length 35 mm
16-402 VDE	Socket wrench , with VDE insulation, 5.5 mm A/F
16-404 VDE	Socket wrench , with VDE insulation, 7.0 mm A/F

To complete the set we recommend for the bottom of the case:

5-240	Warding file set , 6 pieces, wooden handles in a wallet
6-810	Set of allen hex sockets on a ring, 8 pieces
7-405	Trowel , 50 mm
7-415	Rubber beaker for plaster
8-145	ERSA soldering iron 30 S/330 KN/30 W/230 V
8-402	Solder wire (spool) , 100 g, 1.5 mm Ø

COMPACT-MOBIL 7200 ELECTRICIAN'S SERVICE CASE

The trolley case as bordcase for world-wide service



alternative with
VDE-tools
7060



SAFETY 8100 VDE TOOL CASE

A case full of safety for working under voltage up to 1000 V



8100 **BERNSTEIN** SAFETY with tool set

8115 **BERNSTEIN** SAFETY without tool set

Description:

Extremely stable case made from cowhide, red safety-colour. The hinged front plate allows to grip easily the 35 tools placed in partitions and in the tray in the bottom. Behind the tool set there is a partition for protective gloves, security grip etc.. Furthermore there is a separate pocket for connection diagrams and other documents. The case has two locks. At the side it has loops for attaching a carrying strap.

Outside dimensions: 440 x 175 x 310 mm

Weight without tools: approx. 3.000 kg

Weight with tools: approx. 7.500 kg

Tool set:

BERNSTEIN safety tools are produced in accordance with specification EN 60.900 of the Association of German Electrical Engineers (VDE) - the guarantee of optimal safety. The two-colour multilayered insulation (outside red - inside yellow) allows a simple safety-control, practicable at any time: damages of the external red insulation immediately become visible by the yellow layer below.

No.	Description of individual tools
4-344 VDE	Voltage tester , blade 100 x 3.5 mm
13-106 VDE	Side cutter , for piano wire, 165 mm, chrome-plated, with two-colour multilayered insulation
13-207 VDE	Telephone pliers , straight, 210 mm, chrome-plated, with two-colour multilayered insulation
13-208 VDE	Telephone pliers , bent, 205 mm, chrome-plated, with two-colour multilayered insulation
13-707 VDE	Combination pliers , 185 mm, chrome-plated, with two-colour multilayered insulation
13-806 VDE	Wire strippers , 165 mm, chrome-plated, with two-colour multilayered insulation
14-602 VDE	Screwdriver , insulated, blade 100 x 3.5 mm
14-603 VDE	Screwdriver , insulated, blade 100 x 4.0 mm
14-604 VDE	Screwdriver , insulated, blade 125 x 5.5 mm
14-606 VDE	Screwdriver , insulated, blade 150 x 6.5 mm
14-608 VDE	Screwdriver , insulated, blade 175 x 8.0 mm
14-632 VDE	Cross-recess screwdriver , insulated, size 1
14-633 VDE	Cross-recess screwdriver , insulated, size 2
15-522 VDE	Cable stripping knife with blade-protection, blade 35 mm
16-441 VDE	Socket , 10 mm A/F, with two-colour multilayered insulation
16-442 VDE	Socket , as above, 11 mm A/F
16-443 VDE	Socket , as above, 12 mm A/F

No.	Description of individual tools
16-444 VDE	Socket , as above, 13 mm A/F
16-445 VDE	Socket , as above, 14 mm A/F
16-447 VDE	Socket , as above, 17 mm A/F
16-448 VDE	Socket , as above, 19 mm A/F
16-449 VDE	Socket , as above, 22 mm A/F
16-451 VDE	Socket , as above, 24 mm A/F
16-471 VDE	Reversible ratchet , 260 mm long, with two-colour multilayered insulation
16-476 VDE	Rigid extension with locking device, length 125 mm, with two-colour multilayered insulation
16-503 VDE	Single-ended open-jaw wrench , 8 mm A/F, with two-colour multilayered insulation
16-504 VDE	Single-ended open-jaw wrench , as above, 9 mm A/F
16-505 VDE	Single-ended open-jaw wrench , as above, 10 mm A/F
16-506 VDE	Single-ended open-jaw wrench , as above, 11 mm A/F
16-507 VDE	Single-ended open-jaw wrench , as above, 12 mm A/F
16-508 VDE	Single-ended open-jaw wrench , as above, 13 mm A/F
16-509 VDE	Single-ended open-jaw wrench , as above, 14 mm A/F
17-501 VDE	Electrician's protective gloves , size 10
17-521 VDE	Plug-in grip with leather gauntlet for NH-fuses
17-523 VDE	Plastic clip , 170 mm long, with internal spiral spring

VDE TOOL SETS 8150 AND 8160

Safety tools at hand in a plastic case

Description:

Black plastic case made from fracture-proof ABS material. The tools are clearly arranged in foamed plastic recesses. The case has two locks and a handle which may be turned down.

Outside dimensions: 395 x 290 x 90 mm

BERNSTEIN safety tools are produced in accordance with specification EN 60.900 of the Association of German Electrical Engineers (VDE) - the guarantee of optimal safety. The two-colour multilayered insulation (outside red - inside yellow) allows a simple safety control, practicable at any time: damages of the external red insulation immediately become visible by the yellow layer below.

8150 **BERNSTEIN** 24-piece VDE tool set

Weight with tools: 4.100 kg

No.	Description of individual tools
-----	---------------------------------

13-106 VDE	Side cutters for piano wire , 165 mm, chrome-plated, with two-colour multilayered insulation
13-708 VDE	Combination pliers , 205 mm, chrome-plated, with two-colour multilayered insulation
14-601 VDE	Screwdriver , insulated, blade 75 x 2.5 mm
14-606 VDE	Screwdriver , insulated, blade 150 x 6.5 mm
14-632 VDE	Cross-recess screwdriver , insulated, size 1
14-633 VDE	Cross-recess screwdriver , insulated, size 2
15-521 VDE	Cable knife with blade protection, blade length 50 mm
15-522 VDE	Cable stripping knife with blade protection, blade length 35 mm
16-441 VDE	Socket , 10 mm A/F, with two-colour multilayered insulation
16-442 VDE	Socket , as above, 11 mm A/F
16-443 VDE	Socket , as above, 12 mm A/F
16-444 VDE	Socket , as above, 13 mm A/F
16-445 VDE	Socket , as above, 14 mm A/F
16-447 VDE	Socket , as above, 17 mm A/F
16-448 VDE	Socket , as above, 19 mm A/F
16-475 VDE	T-bar , 1/2" square drive, 200 mm, with two-colour multilayered insulation
16-505 VDE	Single-ended open-jaw wrench , 10 mm A/F, with two-colour multilayered insulation
16-506 VDE	Single-ended open-jaw wrench , as above, 11 mm A/F
16-507 VDE	Single-ended open-jaw wrench , as above, 12 mm A/F
16-508 VDE	Single-ended open-jaw wrench , as above, 13 mm A/F
16-509 VDE	Single-ended open-jaw wrench , as above, 14 mm A/F
16-512 VDE	Single-ended open-jaw wrench , as above, 17 mm A/F
16-513 VDE	Single-ended open-jaw wrench , as above, 19 mm A/F
17-531 VDE	Voltage tester 'Steinel Volt Check 3'



8160 **BERNSTEIN** 12-piece VDE tool set

Weight with tools: 2.800 kg

No.	Description of individual tools
-----	---------------------------------

13-106 VDE	Side cutters for piano wire , 165 mm, chrome-plated, with two-colour multilayered insulation
13-207 VDE	Telephone pliers , straight, 210 mm, chrome-plated, with two-colour multilayered insulation
13-707 VDE	Combination pliers , 185 mm, chrome-plated, with two-colour multilayered insulation
13-806 VDE	Wire strippers , 165 mm, chrome-plated, with two-colour multilayered insulation
14-601 VDE	Screwdriver , insulated, blade 75 x 2.5 mm
14-602 VDE	Screwdriver , insulated, blade 100 x 3.5 mm
14-604 VDE	Screwdriver , insulated, blade 125 x 5.5 mm
14-606 VDE	Screwdriver , insulated, blade 150 x 6.5 mm
14-632 VDE	Cross-recess screwdriver , insulated, size 1
14-633 VDE	Cross-recess screwdriver , insulated, size 2
15-521 VDE	Cable knife with blade protection, blade length 50 mm
15-522 VDE	Cable stripping knife with blade protection, blade length 35 mm





BERNSTEIN

Electronic-Tools

Quality for the specialist



ADJUSTING AND SETTING IN ELECTRONICS

A large number of electrical and electronic appliances or assemblies must be adjusted and set after the production process. Even when servicing, when fitting new components or when electrical values have altered owing to age, adjustment is usually necessary in order to restore the optimum functioning of the appliance. Although this should be reduced to a minimum by design measures and technological processes, in order to save costs and to attain a high degree of reliability, adjustment cannot be eliminated completely.

The number of examples which can be quoted is vast: pulse generators in digital systems have a quartz crystal whose nominal frequency is set by a trimming capacitor (this is the case in each digital clock). The offset adjustment in operational amplifiers is carried out using helis. The band-pass filter curve of selective amplifiers must be set in accordance with specific regulations by adjusting the inductances. The list of these problems is endless.

Trimming potentiometers, ten-turn trimmers, adjusting capacitors, inductor cores, adjusting hands of shell-type cores etc. can be set.

Not just any screwdriver should be used. There are special tools which ensure that the setting mechanism is not damaged and that sensitive setting can be carried out. The use of special materials prevents the electrical functioning of the appliance from being affected.

BERNSTEIN use a high-quality, fully insulated plastic material with the trademark "BERNSTEINIT", which is hard and flexible, for adjusting screwdrivers and keys. A material made from hard special plastic is available to satisfy the stringent requirements with regard to torsional strength. BERNSTEIN supply adjusting screwdrivers and keys with inserts made from resilient hard bronze for cores which are especially difficult to remove. This material is true to size even with the smallest dimensions. Since it is only used as small cutting tips in conjunction with BERNSTEINIT material, detuning by the resilient hard bronze is virtually eliminated.

For the industrial adjustment and the work with electrostatically endangered components, BERNSTEIN manufacture a variety of high-grade ceramic bits as well as tweezers with ceramic tips. These ceramic bits made from zirconium oxide (ZrO_2) meet highest standards due to their excellent mechanical, thermic and electrical features. The hardness and breaking strength of the material allows the fabrication and use even in smallest dimensions with greatest possible resistance to wear. BERNSTEIN ceramic bits are extremely resistant and merely show a low thermal conductivity. The blades are non-magnetic, anti-static and electrically insulating, the electric resistance is approx. $10^{10} \Omega/cm$.

In addition to the types indicated in the catalogue, on request BERNSTEIN also manufacture special wanted dimensions or forms also in smaller quantities.

Examples of special tools for adjustment



Sample 97, cross 3 x 0.8 mm



Sample 38, elongated hole 4 x 3 mm



Sample 69, internal bronze blades, 4 and 3 mm



Sample 60, 1 mm slot and edge with inside radius of 2°



Sample 35, hexagon 1.85 mm A/F



Sample 36, triangular adjusting key



Sample 77, bronze insert 1.4 x 0.5 mm



Handle for interchangeable blades 1-725 with cross-recess ceramic bit 3 x 0.6 mm



Sample 372, handle for interchangeable blades with ceramic bit 1-776



Sample 411, double-ended handle for interchangeable blades with ceramic bits



Sample 377, 3 x 1 mm ceramic blade



Sample 386, cross 1.55 x 0.4



Sample 401, bit 0.95 x 0.55 mm



Sample 378, bit 2.2 x 1.2 mm

TRIMMING WITH CERAMIC

Antistatic – antimagnetic – electrically insulating

Ceramic Bits for handles 1-725 or 1-735

Material:

BERNSTEIN ceramic blades belong to the group of oxide ceramic materials (zirconium oxide) which, thanks to their very fine grained structure, provide the highest breaking strength and toughness values obtainable with ceramic materials, namely: great hardness and wear resistance with constantly smooth, sharp edges, high torque, non-magnetic, antistatic and electrically insulating.

1-750 **BERNSTEIN** Ceramic adjusting screwdrivers set 13-pieces in a box with hinged lid

Contents: double-ended handle 1-735 and 12 ceramic bits

Weight: 90 g

Measurements of the ceramic bits in box 1-750

No.	Blade length mm	Blade tip mm	Weight g
1-751	32	0.90 x 0.30	1
1-752	32	1.30 x 0.30	1
1-753	32	1.50 x 0.30	1
1-754	32	1.80 x 0.30	1
1-755	32	1.95 x 0.35	1
1-756	32	2.50 x 0.70	1
1-757	32	3.00 x 0.30	1
1-761	32	1.95 AF	1
1-762	32	2.45 AF	1
1-765	32	size 00	1
1-766	32	size 0	1
1-767	32	2.40 x 0.80	1

Measurements of further ceramic bits

No.	Blade length mm	Blade tip mm	Weight g
1-758	32	3.00 x 0.70	1
1-763	32	2.60 AF	1
1-764	32	size 000	1
1-773	32	0.70 x 1.40	1
1-774	32	3.00 x 1.00	1
1-775	32	1.20 x 1.20	1
1-776	32	1.30 x 0.40	1

ADJUSTING SCREWDRIVERS

with blades from ceramic and antistatic handle, non insulating, with centre top

No.	Overall length mm	Blade tip mm	Weight g
1-851	110	0.90 x 0.30	10
1-852	110	1.30 x 0.30	10
1-853	110	1.50 x 0.30	10
1-854	110	1.80 x 0.30	10
1-855	110	1.95 x 0.35	10
1-856	110	2.50 x 0.70	10
1-857	110	3.00 x 0.30	10
1-858	110	3.00 x 0.70	10
1-861	110	1.95 AF	10
1-862	110	2.45 AF	10
1-863	110	2.60 AF	10
1-864	110	size 000	10
1-865	110	size 00	10
1-866	110	size 0	10
1-867	110	2.40 x 0.80	10
1-873	110	0.70 x 1.40	10
1-874	110	3.00 x 1.00	10
1-875	110	1.20 x 1.20	10
1-876	110	1.30 x 0.40	10



ADJUSTING KEYS

For special trimming

Adjusting screwdrivers with metal inserts

For extremely firm cores or extremely small dimensions

Material:

handle and blade made from flexible BERNSTEINIT with tip from resilient hard bronze



No.	Overall length mm	Blade length mm	Blade Ø mm	Bronze insert mm	Weight g
1-571	120	75	2.5	1.1 x 0.5	4
1-572	120	75	2.5	1.4 x 0.5	4
1-573	120	75	2.5	1.7 x 0.5	4
1-574	120	75	3.0	2.0 x 0.5	4
1-575	120	75	3.0	2.5 x 0.5	4
1-576	120	75	5.0	3.5 x 0.5	5
1-577	120	75	2.5	1.7 x 0.7	4
1-578	120	75	5.0	4.0 x 0.4	5
1-579	120	75	5.0	4.0 x 0.7	5
1-581	120	75	3.0	2.0 x 1.0	4
1-582	120	75	5.0	4.0 x 1.0	5

Double-ended adjusting keys

made from BERNSTEINIT, overall length 135 mm, one end with outside bronze tip, other end with inside bronze insert



No.	Handle length x Ø mm	Blade length x Ø mm	Bronze insert outside/mm	Blade length x Ø mm	Bronze insert inside/mm	Weight g
1-601	85 x 6	20 x 3	1.4 x 0.5	30 x 3	1.4 x 0.5	5
1-602	85 x 6	20 x 3	2.0 x 0.5	30 x 3	2.0 x 0.5	5
1-603	85 x 6	20 x 4	2.5 x 0.5	30 x 4	2.5 x 0.5	5
1-604	85 x 6	20 x 4	3.0 x 0.3	30 x 4	3.0 x 0.3	5
1-605	85 x 6	20 x 5	3.5 x 0.5	30 x 5	3.5 x 0.5	6

Double-ended adjusting keys

made from BERNSTEINIT, overall length 135 mm, both ends with inside bronze insert



No.	Handle length x Ø mm	Blade length x Ø mm	Bronze insert inside/mm	Blade length x Ø mm	Bronze insert inside/mm	Weight g
1-616	85 x 6	20 x 3	2.0 x 0.5	30 x 4	3.0 x 0.3	5
1-617	85 x 6	20 x 4	2.5 x 0.5	30 x 5	3.5 x 0.5	5
1-618	85 x 6	20 x 4	3.0 x 0.3	30 x 5	4.0 x 1.0	6

For industrial trimming

1-725 **Adjusting screwdriver handle for interchangeable blades,** made from BERNSTEINIT with swivel top for 3 mm Ø blades

5

1-735 **Adjusting screwdriver handle for interchangeable blades,** double-ended, for 3 mm Ø blades

6



Interchangeable blades for handles

No.	Blade material	Overall length mm	Blade Ø mm	Blade tip mm	Weight g
1-738	special hard plastic	32	3	1.5 x 0.5	1
1-739	special hard plastic	32	3	3.0 x 0.5	1



Further finish and measurements available on request

ADJUSTING KEYS

For adjusting and setting work of all kinds, e. g. inductor cores and trimming capacitors

Double-ended adjusting keys

Centre section made from flexible BERNSTEINIT with inserts made from special hard plastic

No.	overall length mm	blade Ø mm	blade tips mm	weight g
1-181	180	3.0	Hexagon =1.85 A/F	4
1-182	180	3.0	Square =1.5 A/F	4
1-183	180	4.0	Hexagon =2.6 A/F	4
1-184	180	2.7	Square =3.0 A/F	4
1-185	180	2.4	Slot 1.3	4
			Slot 0.8	4
			3.0 x 0.5	4
			2.4 x 0.3	4
			Bronze 1.1 x 0.5	4
			Bronze 1.7 x 0.7	4

1-280 **5-piece set of adjusting keys**, as above, in a plastic case

Double-ended adjusting keys

made from BERNSTEINIT with screwdriver inserts made from resilient hard bronze

No.	overall length mm	blade Ø mm	bronze inserts mm	weight g
1-335	150	2.5	1.7 x 0.7	1
1-345	150	3.0	1.7 x 0.7	1
1-355	150	4.0	2.0 x 1.0	3
1-365	150	5.0	4.0 x 1.0	4

"Special" adjusting screwdrivers

with blades made entirely from hard special plastic

No.	overall length mm	blade length mm	Ø and blade width mm	weight g
1-415	185	140	2.4	4
1-425	240	195	3.0	5
1-435	240	195	4.0	5

Tuning keys

made from flexible BERNSTEINIT, insert at one end made from hard special plastic

No.	overall length mm	blade Ø mm	blade widths mm	weight g
1-445	350	3.0	3.0 and 2.0	3
1-446	350	4.0	4.0 and 3.0	5

Adjusting screwdrivers

made entirely from BERNSTEINIT, ground at both ends

No.	overall length mm	blade Ø mm	blade widths mm	weight g
1-458	130	5.0	5.0 and 3.5	3
1-459	200	5.0	5.0 and 3.5	5

Adjusting screwdrivers

made entirely from hard special plastic, ground at both ends

No.	overall length mm	blade Ø mm	blade widths mm	weight g
1-465	130	2.0	2.0	1
1-475	200	2.4	2.4	1
1-485	200	3.0	3.0	2
1-495	200	4.0	4.0	3

Adjusting key (slotted key)

made entirely from hard special plastic, slotted at both ends

No.	overall length mm	blade Ø mm	slot width mm	weight g
1-505	120	3.0	1.0	1



ADJUSTING KEYS

For special trimming

Adjusting keys for elongated hole

made entirely from flexible BERNSTEINIT

No.	overall length mm	blade Ø mm	blade tip mm	weight g
1-511	120	3.5	3.5 x 2	4
1-512	120	4.0	4.0 x 3	4

Adjusting key for elongated hole

handle and blade made from flexible BERNSTEINIT
with insert made from special plastic

No.	overall length mm	blade Ø mm	insert Ø mm	blade tip mm	weight g
1-515	120	3.0	2.0	2.0 x 1.4	4

Hexagonal adjusting keys

handle and blade made from flexible BERNSTEINIT
with insert made from special plastic

No.	overall length mm	blade Ø mm	insert Ø mm	hex. mm	weight g
1-521	120	3.0	2.0	1.5 A/F	4
1-522	120	4.0	2.7	1.85 A/F	4
1-523	120	4.0	2.7	1.95 A/F	4
1-524	120	4.0	2.7	2.0 A/F	5
1-525	120	4.0	3.0	2.6 A/F	5

Crosspoint adjusting keys

handle and blade made from flexible BERNSTEINIT
with insert made from special plastic

No.	overall length mm	blade Ø mm	insert Ø mm	cross mm	weight g
1-531	120	3.0	2.4	2.4 x 0.4	4
1-532	120	3.5	2.7	2.7 x 0.8	4
1-533	120	4.0	3.0	3.0 x 0.8	4
1-534	120	5.0	4.0	4.0 x 1.5	5

Square adjusting keys

handle and blade made from flexible BERNSTEINIT
with insert made from special plastic

No.	overall length mm	blade Ø mm	insert Ø mm	square mm	weight g
1-541	120	3.0	2.0	1.5	4
1-542	120	3.5	2.7	2.0	4
1-543	120	5.0	4.0	3.0	5

Screwdriver adjusting keys

handle and blade made from flexible BERNSTEINIT
with insert made from special plastic

No.	overall length mm	blade Ø mm	insert Ø mm	blade tip mm	weight g
1-551	120	3.0	1.4	1.4 x 0.4	4
1-552	120	3.0	2.0	2.0 x 0.4	4
1-553	120	3.5	2.4	2.4 x 0.5	4
1-554	120	3.5	2.7	2.7 x 0.5	4
1-555	120	4.0	3.0	3.0 x 0.6	4

Cross adjusting socket spanner

made entirely from BERNSTEINIT, head black

No.	overall length mm	head Ø mm	inside cross mm	weight g
1-561	120	8.0	4.8 x 1.5	5



RADIO-TV-ADJUSTING SETS

Tools made from high quality BERNSTEINIT material, combined with inserts of hard special plastic

(German Federal Registered Pattern)

1-170 **BERNSTEIN** Television adjusting screwdrivers 7-piece set in a plastic case

Weight: 50 g

No.	Description of individual tools	weight
1-151	Short, single-ended screwdriver, 85 mm, blade made from special plastic, 40 x 3 mm	3 g
1-172	Double-ended screwdriver made from BERNSTEINIT, 65 mm long, one end with bronze insert 3.5 x 0.5 mm, in BERNSTEINIT guide, other end 5 mm wide screwdriver	2 g
1-173	Double-ended adjusting key made from BERNSTEINIT, 165 mm long, one end hexagon key 2.6 mm, other end blunt screwdriver for 2 mm wide slot	4 g
1-174	Feeler gauge made from BERNSTEINIT, 150 mm long, one end with H. F. iron core, other end with brass core, 3 mm Ø	3 g
1-175	Double-ended screwdriver made from BERNSTEINIT, 185 mm long, one end with bronze insert 3.5 x 0.5 mm, other end 4 mm wide screwdriver made from special plastic	5 g
1-176	Double-ended screwdriver made from BERNSTEINIT, 180 mm long, one end with bronze insert 3.5 x 0.5 mm, in BERNSTEINIT guide, other end 3 mm wide screwdriver made from special plastic	3 g
1-177	Double-ended screwdriver made from BERNSTEINIT, 230 mm long, one end with insert for slotted head screws 3 mm, other end screwdriver made from special plastic 3 mm	4 g

1-160 **BERNSTEIN** Television adjusting screwdrivers 7-piece set, made entirely from BERNSTEINIT, in a plastic case

Weight: 45 g

Measurements as per set 1-170

1-900 **BERNSTEIN** Radio adjusting tools 21-piece set in a tool roll

Weight: 200 g

No.	Description of individual tools	weight
1-901	Socket wrench, 6 mm, single-ended, overall length 60 mm	3 g
1-902	Screwdriver, 3.5 mm, with 2 mm wide slot in handle, overall length 150 mm	5 g
1-903	Wrench with pivot, overall length 60 mm	5 g
1-904	Special screwdriver with pivot blade, other end 2.8 mm screwdriver blade, overall length 130 mm	11 g
1-905	Combined socket wrench 4.5 mm A/F, with inserted bronze screwdriver blade 3.5 mm	4 g
1-906	Screwdriver double-ended, widths 5 mm and 3 mm	2 g
1-909	Engineer's mirror with extension handle, made entirely from BERNSTEINIT, overall length 260 mm	9 g
	Double-ended hexagonal adjusting socket wrenches, one end BERNSTEINIT, other end brass, overall length 140 mm. The metal and plastic socket wrenches are extremely thin in order to penetrate deep into each coil core.	
1-911	2.5 mm,	2 g
1-912	3.0 mm,	3 g
1-913	3.5 mm,	3 g
1-914	4.0 mm,	5 g
1-915	4.5 mm,	6 g
1-916	5.0 mm,	7 g
1-917	5.5 mm,	7 g
1-918	6.0 mm,	9 g
1-174	Feeler gauge for radio, one end H. F. iron core, other end brass core, 150 x 4 mm Ø	5 g
2-265-1	Black test prod with banana plug connection	9 g
2-265-2	Red test prod with banana plug connection	9 g
5-107	Engineer's steel tweezers with bent tips, length 150 mm	22 g
4-311	Screwdriver for grub screws, 2.8 mm, blade chrome vanadium	10 g



ADJUSTING SCREWDRIVERS

For all adjusting work which requires a ground blade

Adjusting screwdrivers with blade-tip made from special hard plastic

Material:

BERNSTEINIT with insert made from special plastic (German Federal Registered Pattern)

The BERNSTEINIT blade makes the screwdriver flexible, and the hard special plastic insert at the tip gives the blade exceptional torsional strength.

No.	overall length mm	blade length mm	blade Ø mm	blade width mm	weight g
1-151	85	40	3.0	3.0	3
1-152	85	40	4.0	4.0	3
1-153	175	130	3.0	2.0	4
1-154	175	130	4.0	3.0	5
1-155	175	130	5.0	3.5	6
1-156	175	130	5.0	4.0	6
1-157	225	180	4.0	3.0	6

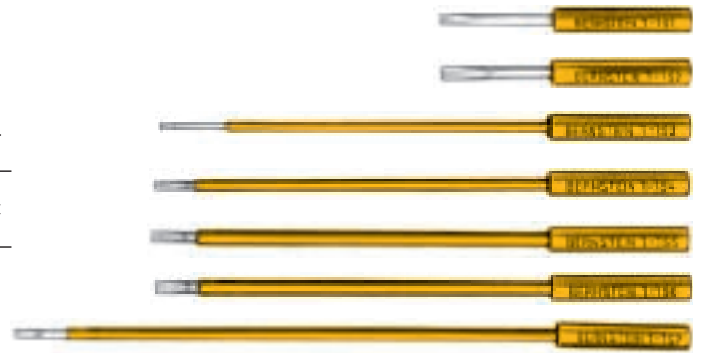

1-150 **BERNSTEIN** Adjusting screwdrivers
7-piece set, as described above, clearly arranged in a plastic case
Weight: 55 g



Adjusting screwdrivers with metal inserts made from resilient hard bronze

For extremely firm cores or extremely small dimensions

Material:

Handle made from BERNSTEINIT, blades made from special plastic with bronze tips

No.	overall length mm	blade length mm	blade Ø mm	bronze insert mm	weight g
1-301	200	155	2.7	1.4 x 0.5	4
1-302	200	155	2.7	2.0 x 0.5	4
1-303	200	155	2.7	2.5 x 0.5	4
1-304	200	155	2.7	1.7 x 0.7	4
1-305	125	80	2.4	1.1 x 0.5	3
1-306	125	80	2.4	1.7 x 0.7	3
1-307	125	80	2.4	2.0 x 0.5	3



1-300 **BERNSTEIN** Adjusting screwdrivers,
7-piece set, as described above, clearly arranged in a plastic case
Weight: 50 g



Interchangeable adjusting screwdrivers

made from BERNSTEINIT, insert at one end made from hard special plastic, blade supplied loose (no. 1-456) or with screw-headed handle for inserting the blade (No. 1-455) either way

No.	handle length mm	blade length mm	Ø and blade widths mm	weight g
1-455	60	110	3.0 and 2.0	9
1-456	-	110	3.0 and 2.0	1
4-776	Screw-headed handle, 3 mm			8



ADJUSTING TOOL SETS

1-180 **BERNSTEIN** **Adjusting tools**
7-piece set in a plastic case
Weight: 50 g



No.	Description of individual tools
	Adjusting screwdrivers made from BERNSTEINIT with hard special plastic insert
1-151	Overall length 85 mm, blade 40 x 3.0 mm
1-152	Overall length 85 mm, blade 40 x 4.0 mm
1-153	Overall length 175 mm, blade 130 x 2.0 mm
1-155	Overall length 175 mm, blade 130 x 3.5 mm
1-181	Double-ended adjusting key made from BERNSTEINIT with hard special plastic inserts, overall length 180 mm, one end hexagonal 1.85 mm A/F, other end square 1.5 mm A/F
1-182	Double-ended adjusting key made from BERNSTEINIT with hard special plastic inserts, overall length 180 mm, one end hexagonal 2.6 mm A/F, other end square 3.0 mm A/F
1-306	Adjusting screwdriver made from special plastic, overall length 125 mm, blade 80 x 2.5 mm, with bronze insert 1.7 x 0.7 mm

1-190 **BERNSTEIN** **Adjusting tools**
7-piece set
in an imitation leather case
Weight: 60 g



No.	Description of individual tools
	Adjusting screwdrivers made from BERNSTEINIT with hard special plastic insert
1-153	Overall length 175 mm, blade 130 x 2.0 mm
1-154	Overall length 175 mm, blade 130 x 3.0 mm
1-155	Overall length 175 mm, blade 130 x 3.5 mm
1-181	Double-ended adjusting key made from BERNSTEINIT with hard special plastic inserts, overall length 180 mm, one end hexagonal 1.85 mm A/F, other end square 1.5 mm A/F
1-182	Double-ended adjusting key made from BERNSTEINIT with hard special plastic inserts, overall length 180 mm, one end hexagonal 2.6 mm A/F, other end square 3.0 mm A/F
1-306	Adjusting screwdriver made from special plastic, overall length 125 mm, blade 80 x 2.5 mm, with bronze insert 1.7 x 0.7 mm
1-505	Slotted key made from special plastic, 120 x 3 mm Ø, slot at both ends 1 mm

1-970 **BERNSTEIN** **Adjusting tools**
21-piece set in a tool roll
Weight: 240 g

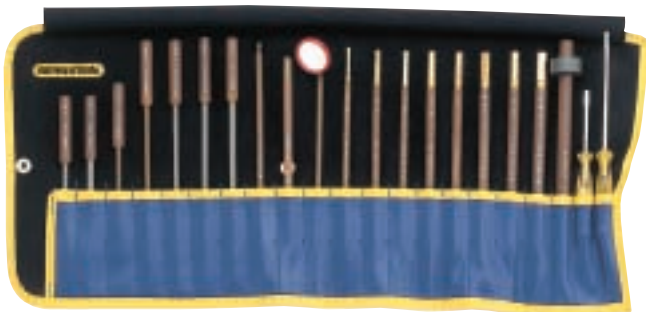

No.	Description of individual tools
	Adjusting screwdrivers, made entirely from hard special plastic, No. 1-971 and 1-972 made from BERNSTEINIT, tip made from hard special plastic
1-151	Overall length 85 mm, blade 40 x 3.0 mm
1-152	Overall length 85 mm, blade 40 x 4.0 mm
1-971	Overall length 125 mm, blade 80 x 2.0 mm
1-972	Overall length 175 mm, blade 130 x 2.0 mm
1-973	Overall length 180 mm, blade 135 x 3.0 mm
1-974	Overall length 180 mm, blade 135 x 3.5 mm
1-975	Overall length 180 mm, blade 135 x 4.0 mm
1-174	Feeler gauge for radio and television, 150 x 4 mm Ø
1-978	Engineer's mirror with extension handle, made entirely from BERNSTEINIT, with 6 mm screwdriver ground in handle
	Double-ended hexagonal adjusting socket wrenches, one end BERNSTEINIT, other end brass, overall length 140 mm. The metal and plastic socket wrenches are extremely slim so that they can engage deeply in every coil core
1-911	Adjusting socket wrench 2.5 mm
1-912	Adjusting socket wrench 3.0 mm
1-913	Adjusting socket wrench 3.5 mm
1-914	Adjusting socket wrench 4.0 mm
1-915	Adjusting socket wrench 4.5 mm
1-916	Adjusting socket wrench 5.0 mm
1-917	Adjusting socket wrench 5.5 mm
1-918	Adjusting socket wrench 6.0 mm
2-236	Valve tapping hammer
4-315	Radio screwdriver 40 x 3 mm
4-311	Screwdriver for grub screws 80 x 2.8 mm

ADJUSTING TOOL SETS

1-250 **BERNSTEIN** Special tools and adjusting tools 15-piece set in a leather case Weight: 180 g

No.	Description of individual tools
1-151	Adjusting screwdriver made from BERNSTEINIT, with blade made from hard special plastic, overall length 85 mm, blade 40 x 3.0 mm
1-153	Adjusting screwdriver made from BERNSTEINIT, with hard special plastic insert, overall length 175 mm, blade 130 x 2.0 mm
1-154	Adjusting screwdriver made from BERNSTEINIT, with hard special plastic insert, overall length 175 mm, blade 130 x 3.0 mm
1-181	Double-ended adjusting key made from BERNSTEINIT, with hard special plastic inserts, overall length 180 mm, one end hexagonal 1.85 mm A/F, other end square 1.5 mm A/F
1-182	Double-ended adjusting key made from BERNSTEINIT, with hard special plastic inserts, overall length 180 mm, one end hexagonal 2.6 mm A/F, other end square 3.0 mm A/F
1-305	Adjusting screwdriver made from special plastic, overall length 125 mm, blade 80 x 2.5 mm, with bronze insert 1.1 x 0.5 mm
1-307	Adjusting screwdriver as above, with bronze insert 2.0 x 0.5 mm
1-978	Engineer's mirror with extension handle, made entirely from BERNSTEINIT, handle ground as 6 mm screwdriver
2-126	Desoldering lever, slotted at one end, nickel-plated and insulated, with plastic handle
2-135	Core remover, for easy removal of damaged cores
2-265	Pair of test prods, red and black, extremely slim, pointed and flexible, 155 mm, blade made from 1 mm steel wire, with banana plug connection, fully insulated
4-301	Miniature screwdriver, overall length 85 mm, blade 40 x 1.8 mm
4-311	Screwdriver for grub screws, overall length 140 mm



1-200 **BERNSTEIN** Special tools and adjusting tools 12-piece set in an imitation leather case Weight: 150 g

No.	Description of individual tools
1-153	Adjusting screwdriver made from BERNSTEINIT, with hard special plastic insert, overall length 175 mm, blade 130 x 2.0 mm
1-181	Double-ended adjusting key made from BERNSTEINIT, with hard special plastic inserts, overall length 180 mm, one end hexagonal 1.85 mm A/F, other end square 1.5 mm A/F
1-182	Double-ended adjusting key made from BERNSTEINIT, with hard special plastic inserts, overall length 180 mm, one end hexagonal 2.6 mm A/F, other end square 3.0 mm A/F
1-301	Adjusting screwdriver made from special plastic, overall length 200 mm, blade 155 x 2.7 mm, with bronze insert 1.4 x 0.5 mm
1-304	Adjusting screwdriver as above, bronze insert 1.7 x 0.7 mm
1-505	Slotted key made from special plastic, 120 x 3 mm Ø, 1 mm slot at both ends
1-978	Engineer's mirror with extension handle, made entirely from BERNSTEINIT, handle ground as screwdriver
2-265	Pair of test prods, red and black, extremely slim, pointed and flexible, 155 mm, blade made from 1 mm steel wire, with banana plug connection, fully insulated
4-301	Miniature screwdriver, overall length 85 mm, blade 40 x 1.8 mm
5-107	Steel tweezers with bent tips, 150 mm long
5-301	Special sheet-metal scissors, serrated, 110 mm long



SPECIAL TOOLS



No.	Description	Length	Weight
2-265	Test prods , extremely slim, pointed and flexible, blade made from 1 mm steel wire, with banana plug connection, fully insulated, available in red (2-265-1) and black (2-265-2)	155 mm	9 g
2-125	Desoldering lever for lifting fixed components when desoldering, ends at different angles (40°/70°), slotted at both ends, nickel-plated, insulated	125 mm	7 g
2-126	Desoldering lever , slotted at one end, nickel-plated, round, insulated shank and hexagonal plastic handle	115 mm	10 g
2-127	Tin knife with pointed, sharp blade, for cutting circuit paths and working printed circuit boards, round, insulated shank and hexagonal plastic handle	115 mm	14 g
2-128	Tin scraper with blade of sharp parting tool shape for scraping off excess solder and solder bridges, round, insulated shank and hexagonal plastic handle	115 mm	14 g
2-101	Tin knife with ceramic blade for working printed circuit boards, handle from conductive black plastic	105 mm	9 g
2-135	Core remover for easy removal of damaged cores in coils etc., flexible metal tip 1.5 x 0.5 x 30 mm, nickel-plated blade, BERNSTEINIT handle	175 mm	8 g
2-145	Screwdriver with guide sleeve for easy and accurate setting of spindle resistors and potentiometers with slotted axles up to 3.2 mm Ø, nickel-plated blade, plastic-handle	140 mm	12 g
2-151	Triangular scraper in brass tool holder, nickel-plated, triangular blade made from hollow ground special steel (80 mm long), insertable at both ends and adjustable in holder	90 mm	26 g
2-152	Tool holder , nickel-plated brass, with collets at both ends for holding tools from 0 to 3 mm Ø	110 mm	32 g
2-155	Claw-type gripper , nickel-plated brass, with 4 wire claws, small version with clip	120 mm	21 g
2-157	Flexible claw-type grip with 4 sprung claws, to reach inaccessible areas with free play, nickel-plated, long version	600 mm	75 g
2-161	Magnetic bar with double ball-and-socket joint, slewable into any position, diameter of bar 8 mm	215 mm	34 g
2-165	Contact cleaner , brush-type, with wire bristles, nickel-plated	35 mm	2 g
2-166	Glass fibre contact cleaner brush with rotary mechanism, plastic casing	115 mm	10 g
2-167	Replacement glass fibre for 2-166	40 mm	1 g
2-234	High voltage tester made from BERNSTEINIT with steel tip	190 mm	15 g
2-236	Valve tapping hammer made from BERNSTEINIT	170 mm	15 g
2-245	Resilient adjusting key for bending and adjusting fine contacts, nickel-plated blade, BERNSTEINIT handle	135 mm	11 g

SPECIAL TOOLS

No.	Description	Length	Weight
1-909	Engineer's mirror , magnifying, concave mirror 23 mm Ø, with extension handle, made entirely from BERNSTEINIT, fully insulated version	145/260 mm	9 g
1-978	Engineer's mirror as above, but extension handle with ground 6 mm screwdriver blade, made from BERNSTEINIT	145/260 mm	9 g
2-275	Repair mirror , stainless, magnifying, concave mirror 21 mm Ø, with BERNSTEINIT handle	180 mm	7 g
2-281	Double-jointed mirror , slewable into any position, nickel-plated, with insulated handle and clip, mirror 30 mm Ø	195 mm	33 g
2-282	Telescopic mirror with double joint, slewable into any position, nickel-plated, pocket clip, mirror 23 mm Ø	150-460 mm	26 g
2-285	Inspection mirror with illuminated mirror area and double joint, slewable into any position, nickel-plated, pocket clip, for 2 batteries type Mignon 1.5 V	200 mm	45 g
2-291	Plastic magnifying glass with biconvex lens, 5 x magnification, 30 mm Ø, short, practical shape	70 mm	6 g
2-293	Hand magnifier , light metal surround, biconvex lens, 65 mm Ø, 3.0 x magnification	115 mm	52 g
2-295	Hand magnifier, illuminated with bi-aspherical PMX-light-weight lens, 35 mm Ø, 4x magnification, 16.0 Dpt., with 2 batteries type Mignon 1.5 V	125 mm	80 g
2-655	Pocket inspection lamp MITILITE LASER SPOT with bent fibre optic adaptor for close inspection of small, tight, hard-to-see areas. The most powerful pocket lite with pre-focused reflector, clip and magnet, handy, watertight and unbreakable incl. 2 Alkaline-batteries ea. 1.5 V	125 mm	50 g
2-655-80	Pocket inspection lamp as discribed above, with additional straight fibre optic adaptor, 80 mm long		



SPECIAL TOOLS



No.	Description	Length	Weight
2-130	Set of spring hooks , 6-piece, nickel-plated, for gripping and straightening, inserting and removing tension and compression springs of various kinds, hook screwing onto handle, in a plastic case	hook with handle 205 mm	39 g
2-131	Spring hook , nickel-plated and insulated, for inserting and removing tension and compression springs	205 mm	10 g
2-132	Spring hook , nickel-plated and insulated, for inserting and removing tension springs	175 mm	10 g
2-133	Spring hook with ring , nickel-plated, for inserting and removing strong tension springs	195 mm	13 g
2-306	Extractor with self-centring extractor hook to remove small bearings and similar parts. Span 60 mm, grip depth 50 mm	105 mm	200 g
2-307	Double lamp extractor , nickel-plated, for plug-in lamps in long-distance data transmission systems etc., suitable for cap-type lamps T5.5 / T5.5K / T6.8 / B7s, in accordance with DIN 49838	100 mm	11 g
2-601	IC tweezers for gripping, inserting and removing, especially suitable for narrow components, nickel-plated	125 mm	20 g
2-605	PLCC-puller for lifting out plug-in PLCC's	135 mm	6 g
2-620	PLCC extractor for easy removal of plug-in PLCC's	100 mm	22 g
2-701	Insertion tool with sensor , wire connection, without soldering, screwing and stripping, cutting the remaining length, all in one operation	185 mm	60 g
2-702	Insertion tool for system MDF 71 to connect cable and switch wire	165 mm	60 g

DEMAGNETIZING THROTTLES

Indispensable for the service

2-305 Demagnetizing throttle

complete with 2 m connecting cable and Euro-flat plug

The device removes unwanted magnetism from sound heads, which can cause disturbing extraneous noise and losses of high-frequency sound.

Also suitable for erasing magnetic tapes.

Technical data: Dimensions: 105 mm x 40 mm Ø
Voltage: 220 V = 50 Hz
Low voltage on request

Weight: 300 g



2-505 Demagnetizing throttle

for **colour televisions**
and **colour monitors**

complete with 4 m connecting cable and Euro-flat plug

When servicing colour televisions, the most important requirement for setting the purity of colour and convergence accurately is the demagnetisation of the colour television tube.

There are colour televisions and colour monitors which are so strongly magnetized that the intern demagnetisation is not successful enough. For these cases the demagnetizing throttle 2-505 is used, which neutralizes even the strongest magnetic fields. An installed thermo-element interrupts as protection of overheating after approx. 1.5 min.

Technical data: Diameter: 350 mm
Voltage: 220 V
Current consumption: approx. 2 A
Thermo-element

Weight: approx. 1.000 g



TESTING TOOLS

2-705 Contact-free voltage detector "Voltstick"

Quick and accurate detection of cable breaks, blown fuses and damaged switches by optical and acoustic indication

Power supply: 2 batt. typ AAA, 1.5 V
Weigh: 40 g

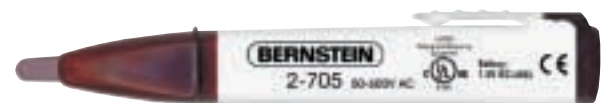

2-751 Test headphone

Usable for

- the check of switching circuitry
- the connection to the line without drawing loop current (monitor)
- verification the presence of DC current and permission to follow a tone on different pairs

Technical data:
1 x 600 ohm, changeable from 600 up to 10.000 ohm,
with fine adjuster, cable length including test prods 1450 mm,
maximum load 2 W

Weight: 240 g





BERNSTEIN

Electronic-Tools

Quality for the specialist



BERNSTEIN-Pliers are made from specially selected top-quality special steels. The blanks are drop-forged and are then further processed in accordance with the latest production techniques.

BERNSTEIN pliers are oil-hardened and all cutting pliers additionally undergo subsequent induction hardening. All pliers are carefully produced for the cutting capacities indicated, either with a side face for cutting hard and soft wire or without a side face for flush cutting soft wire only.

BERNSTEIN pliers without side faces are marked with a dot on the head of the pliers. In the case of pliers for electronic engineers, the cutting capacities are indicated on the handle.

All BERNSTEIN pliers are guaranteed tools. Defective pliers will be replaced if they contain material or production defects.

Special design features

Most BERNSTEIN pliers for electronic engineers are produced with a **box joint**.



As a result of this expensive design, optimum parallel guiding edges is obtained and the service lives are long.

The decision to produce a **lap joint**



or a **lay-on joint**



is made according to the type of pliers and the use.

Finishes

BERNSTEIN-pliers are supplied as standard in the following finishes:

Bright-polished chrome-plated
Fine-polished and bright-burnished
Bright steel-polished
Nickel-plated
Burnished

Additional insulation or other types of finish are indicated by a suffix after the article number

Finish	No.suffix
chrome-plated, polished	without
with transparent hand-guard (=BERNSTEINIT-insulation)	-1
with transparent or coloured insulation	-2
with conductive black hand-guard	-13
with yellow-grey hand-guard	-20
nickel-plated	-3
with transparent hand-guard (=BERNSTEINIT-insulation)	-4
with coloured hand-guard insulation	-5
with coloured insulation	-6
steel-polished	
with coloured hand-guard insulation	-8
with coloured insulation	-9
with conductive black hand-guard	-13
burnished	-10
with coloured insulation	-12
bright-burnished, fine-polished	
with yellow-grey hand-guard	-14
with conductive black-yellow hand-guard	-15
Safety insulation	
VDE-safety insulation	-VDE
two-colour multilayered insulation	-VDE
ESD/EGB-insulations	
conductive black hand-guard	-13
conductive black-yellow hand-guard	-15

Only the finishes indicated in the descriptions of the pliers are available from stock, all other finishes are available on request.

Packing

All pliers are supplied in skin packs as standard. Packing in plastic bags can also be selected if required. Both are for recycling. Quantities of 10 pairs of pliers per type are packed in a 3-coloured covered box and are clearly labelled.



SPECIAL ELECTRONIC PLIERS EUROline

Box joint

Double leaf spring

High quality steel

Fine polished and bright burnished

For dazzle-free working, high corrosion protection

Ergonomically formed bicoloured hand-guard from anti-slide material



3-651-14



3-651-14 DR



3-652-14



3-653-14



3-654-14



3-656-14



3-671-14



3-672-14



3-673-14



3-674-14

CUTTING PLIERS

No.	Length		Finish	Cutting capacity mm Ø			Weight g
	mm	inches		Copper-wire	Soft-wire	Hard-wire	

EUROline mini side cutters

with very slim, rounded head for finest operations

3-651-14	120	4 3/4	without side face	1.2	0.6	-	55
3-651-14 DR	120	4 3/4	without side face with wire retaining spring	1.2	0.6	-	55

EUROline mini side cutters

with very slim, pointed head for finest operations

3-652-14	120	4 3/4	without side face	1.0	0.6	-	55
3-653-14	120	4 3/4	without side face, with special flat cutting edge	1.0	0.6	-	55

EUROline side cutters

with slim rounded head, available with or without side face

3-654-14	125	5	with side face	1.5	1.0	0.4	60
3-655-14	125	5	without side face	1.5	1.0	-	60

EUROline side cutters

with slim, pointed head, available with or without side face

3-656-14	125	5	with side face	1.2	1.0	0.4	60
3-657-14	125	5	without side face	1.2	1.0	-	60

EUROline end cutters

extremely slim, without side face, for precision work at points difficult to reach

3-671-14	130	5 1/8	straight	0.6	-	-	60
3-672-14	130	5 1/8	cutting edge 20° angular	0.6	-	-	60

EUROline top cutters

extremely slim, without side face, head 45° angular, for flush cutting directly in front of and behind the components

3-673-14	130	5 1/8	cutting edge inside	0.6	-	-	60
3-674-14	130	5 1/8	cutting edge outside	0.6	-	-	60

SPECIAL ELECTRONIC PLIERS EUROline

Box joint 
 Double leaf spring
 High quality steel
 Fine polished and bright burnished
 For dazzle free working, high corrosion protection
 Ergonomically formed bicoloured hand-guard
 from anti-slide material



3-681-14

ROUND, FLAT AND SNIPE NOSE PLIERS

No.	mm	length inches	finish	weight g
-----	----	------------------	--------	-------------

EUROline round nose pliers

extremely slim

3-681-14	130	5 1/8	plain jaws	60
----------	-----	-------	------------	----

EUROline flat nose pliers

extremely slim

3-682-14	130	5 1/8	plain jaws	60
----------	-----	-------	------------	----

EUROline snipe nose pliers

extremely slim

3-683-14	130	5 1/8	plain jaws	55
----------	-----	-------	------------	----



3-682-14



3-683-14

3-670 EUROline Set of pliers, 4 pieces

in black imitation leather case
 with zip fastener and velvet grey lining

Weight: 390 g

Tool set:

No.	Description of individual tools
3-651-14	Mini side cutters , 120 mm, without side face, for soft wire up to 0.6 mm, copper wire up to 1.2 mm
3-672-14	End cutters , 130 mm, cutting edge 20° angular, for copper wire up to 0.6 mm
3-682-14	Flat nose pliers , 130 mm, plain jaws
3-683-14	Snipe nose pliers , 130 mm, plain jaws



SPECIAL ELECTRONIC PLIERS EUROline-Conductive



Box joint 
Double leaf spring
High quality steel

Fine polished and bright burnished, for dazzle free working
Ergonomically formed bicoloured hand-guard from
conductive anti-slide material

The pliers of this program have been tested with good results
by a well-known electronic group adequate to IEC 61340



CUTTING PLIERS

No.	Length		Finish	cutting capacity mm Ø			Weight g
	mm	inches		Copper-wire	Soft wire	Hard wire	

Mini side cutters EUROline-Conductive

with very slim, rounded head for finest operations

3-651-15	120	4 3/4	without side facee	1.2	0.6	-	55
3-651-15 DR	120	4 3/4	without side face, with retaining spring	1.2	0.6	-	55

Mini side cutters EUROline-Conductive

with very slim, pointed head for finest operations

3-652-15	120	4 3/4	without side face	1.0	0.6	-	55
3-653-15	120	4 3/4	without side face, with special flat cutting edge	1.0	0.6	-	55

Side cutters EUROline-Conductive

with slim, rounded head,
available with or without side face

3-654-15	125	5	with side face	1.5	1.0	0.4	60
3-655-15	125	5	without side face	1.5	1.0	-	60

Side cutters EUROline-Conductive

with slim, pointed head,
available with or without side face

3-656-15	125	5	with side face	1.2	1.0	0.4	60
3-657-15	125	5	without side face	1.2	1.0	-	60

End cutters EUROline-Conductive

extremely slim, without side face, for precision
work at points difficult to reach

3-671-15	130	5 1/8	straight	0.6	-	-	60
3-672-15	130	5 1/8	cutting edge 20° angular	0.6	-	-	60

Top cutters EUROline-Conductive

extremely slim, without side face, head 45° angular,
for flush cutting directly in front of and
behind the components.

3-673-15	130	5 1/8	cutting edge inside	0.6	-	-	60
3-674-15	130	5 1/8	cutting edge outside	0.6	-	-	60

SPECIAL ELECTRONIC PLIERS EUROline-Conductive

Box joint 

Double leaf spring

High quality steel

Fine polished and bright burnished, for dazzle free working

Ergonomically formed bicoloured hand-guard from conductive anti-slide material



3-681-15

ROUND, FLAT AND SNIPE NOSE PLIERS

No.	mm	Length inches	Finish	Weight g
-----	----	------------------	--------	-------------

Round nose pliers EUROline-Conductive

extremely slim

3-681-15	130	5 1/8	plain jaws	60
----------	-----	-------	------------	----



3-682-15

Flat nose pliers EUROline-Conductive

extremely slim

3-682-15	130	5 1/8	plain jaws	60
----------	-----	-------	------------	----



3-683-15

Snipe nose pliers EUROline-Conductive

extremely slim

3-683-15	130	5 1/8	plain jaws	55
----------	-----	-------	------------	----

3-680 EUROline-Conductive Set of pliers, 4 pieces

in black imitation leather case with zip fastener and velvet grey lining

Weight: 390 g



Tool set:

No.	Description of individual tools
3-651-15	Mini side cutters , 120 mm, without side face, for soft wire up to 0.6 mm, copper wire up to 1.2 mm
3-672-15	End cutters , 130 mm, cutting edge 20° angular, for copper wire up to 0.6 mm
3-682-15	Flat nose pliers , 130 mm, plain jaws
3-683-15	Snipe nose pliers , 130 mm, plain jaws



SPECIAL ESD/EGB ELECTRONIC PLIERS

Box joint 
 Double leaf spring
 Bright steel-polished
 With conductive black hand-guard



CUTTING PLIERS

No.	Length		Finish	Cutting capacity mm Ø		Weight g
	mm	inches		Soft wire	Hard wire	

Side cutters

with slim, rounded head, available with or without side face

3-601-13	120	4 3/4	with side face	1.0	0.4	70
3-602-13	120	4 3/4	without side face	1.0	-	70

Side cutters

with slim, pointed head, available with or without side face

3-603-13	120	4 3/4	with side face	0.8	-	65
3-604-13	120	4 3/4	without side face	0.8	-	65

End cutters

with angular tips and oblique cutting edge,
 for flush cutting, for soft wire only

3-606-13	120	4 3/4	without side face	0.4	-	55
----------	-----	-------	-------------------	-----	---	----

ROUND, FLAT AND SNIPE NOSE PLIERS

No.	article	Length		Finish	Weight g
		mm	inches		
3-631-13	Round nose pliers	120	4 3/4	plain jaws	55
3-632-13	Flat nose pliers	120	4 3/4	plain jaws	55
3-633-13	Snipe nose pliers	120	4 3/4	plain jaws	55
3-634-13	Snipe nose pliers, angular	120	4 3/4	plain jaws	55

SETS OF ELECTRONIC PLIERS

3-650 Set of conductive pliers, 5 pieces

in a practical table support from antistatic material

Tool set:

Weight: 320 g

No.	Description of individual tools
3-601-13	Side cutters , 120 mm, for hard wire up to 0.4 mm, for soft wire up to 1.0 mm
3-631-13	Round nose pliers , 120 mm, plain jaws
3-632-13	Flat nose pliers , 120 mm, plain jaws
3-633-13	Snipe nose pliers , 120 mm, plain jaws
3-634-13	Snipe nose pliers , angular, 120 mm, plain jaws

3-630 Set of conductive pliers, 3 pieces

in a wallet of recycable nylon

Tool set:

Weight: 240 g

No.	Description of individual tools
3-601-13	Side cutters , 120 mm, for hard wire up to 0.4 mm, for soft wire up to 1.0 mm
3-632-13	Flat nose pliers , 120 mm, plain jaws
3-633-13	Snipe nose pliers , 120 mm, plain jaws



3-601-13

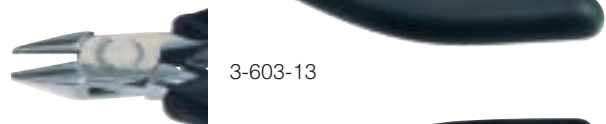

3-603-13



3-606-13



3-631-13

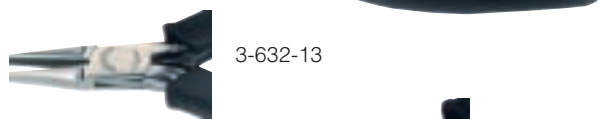

3-632-13

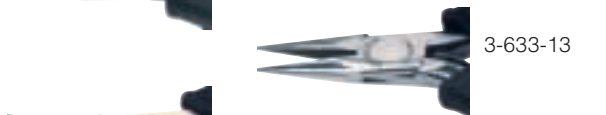

3-633-13

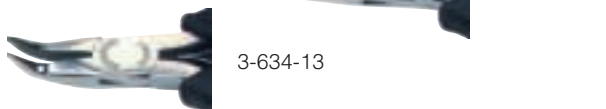

3-634-13



SPECIAL ESD/EGB ELECTRONIC PLIERS

Lap joint



Double leaf spring

Bright polished - chrome-plated

With conductive black handguard



CUTTING PLIERS

No.	Length		Finish	Cutting capacity mm Ø		Weight g
	mm	inches		Soft wire	Hard wire	

Side cutters

with slim, rounded head

3-901-13	125	5	chrome-plated bright polished, with conductive black hand-guard	1.0	0.4	75
----------	-----	---	---	-----	-----	----

Side cutters

with slim, pointed head and special flat cutting edge,
for soft wire only

3-902-13	125	5	chrome-plated bright polished, with conductive black hand-guard	0.8	-	75
----------	-----	---	---	-----	---	----

Top cutters

with 3 mm wide cutting edge, jaw length 20 mm,
without side face, for flush cutting, for soft wire only

3-905-13	125	5	chrome-plated bright polished, with conductive black hand-guard	0.8	-	80
----------	-----	---	---	-----	---	----

End cutters

with angular tips and oblique cutting edge,
without side face, for flush cutting, for soft wire only

3-906-13	125	5	chrome-plated bright polished, with conductive black hand-guard	0.8	-	80
----------	-----	---	---	-----	---	----

ROUND, FLAT AND SNIPE NOSE PLIERS

No.	Length		Finish	Weight g
	mm	inches		

Round nose pliers with plain jaws

3-931-13	125	5	chrome-plated bright polished, with conductive black hand-guard	80
----------	-----	---	---	----

Flat nose pliers with plain jaws

3-932-13	125	5	chrome-plated bright polished, with conductive black hand-guard	80
----------	-----	---	---	----

Snipe nose pliers with plain jaws

3-933-13	125	5	chrome-plated bright polished, with conductive black hand-guard	80
----------	-----	---	---	----



3-901-13



3-902-13



3-905-13



3-906-13



3-931-13



3-932-13



3-933-13

SPECIAL ELECTRONIC PLIERS

Box joint 

Compression spring, Special steel

Especially light and slim, designed for the Electronic engineers working on small printed circuits



3-051-2

No.	Length		Finish	Cutting capacity mm Ø		Weight g
	mm	inches		Soft wire	Hard wire	

Side cutters

with recess in the cutting edge, for gripping components not to be worked on, cutting area 3.3 mm wide, without side face, for flush cutting, for soft wire only



3-052-2

3-051-2	120	4 3/4	chrome-plated bright polished, with transparent insulation	0.8	-	70
---------	-----	-------	--	-----	---	----



Oblique cutters

with recess in the cutting edge, for gripping components not to be worked on, cutting area 4.0 mm wide, without side face, for flush cutting, for soft wire only



3-053-2

3-052-2	120	4 3/4	chrome-plated bright polished, with transparent insulation	1.0	-	70
---------	-----	-------	--	-----	---	----



Oblique cutters

with 4.0 mm wide recessed cutting edge, ends of wire are shortened uniformly to 1.5 mm, for soft wire only



3-058-2

3-053-2	120	4 3/4	chrome-plated bright polished, with transparent insulation	0.8	-	70
---------	-----	-------	--	-----	---	----

Mini top cutters

with cutting edge only 2.0 mm wide, jaw length 20 mm, without side face, for flush cutting, for precision work, for soft wire only

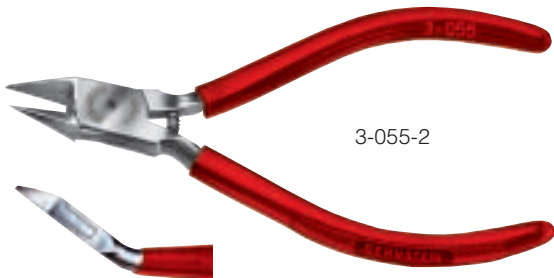

3-055-2

3-058-2	120	4 3/4	chromed-plated bright polished, with transparent insulation	0.4	-	40
---------	-----	-------	---	-----	---	----

Side cutters

with angular handles (25°), straight cutting edge, without side face, for flush cutting, for soft wire only



3-055-2	120	4 3/4	chrome-plated bright polished, with transparent insulation	0.8	-	70
---------	-----	-------	--	-----	---	----

Mini end cutters

with angular tips and oblique cutting edge, without side face, for flush cutting, for precision work at points difficult to reach, for soft wire only



3-057-2

3-057-2	120	4 3/4	chrome-plated bright polished, with transparent insulation	0.6	-	45
3-164-2	140	5 1/2	chrome-plated bright polished, with transparent insulation	0.8	-	80

SPECIAL ELECTRONIC PLIERS

Box joint 

Compression spring, Special steel

Especially light and slim, designed for the Electronic engineers working on small printed circuits

No.	Length		Finish	Cutting capacity mm Ø		Weight g
	mm	inches		Soft wire	Hard wire	

Side cutters

with slim, pointed head, available with or without side face

3-061-2	120	4 3/4	chrome-plated bright polished, with transparent insulation with side face	1.2	0.4	75
3-062-2	120	4 3/4	without side face	1.2	-	75

Side cutters

with slim, pointed head and **straight** cutting edge available with or without side face

3-063-2	120	4 3/4	chrome-plated bright polished, with transparent insulation with side face	1.2	0.4	70
3-064-2	120	4 3/4	without side face	1.2	-	70

Side cutters

with slim, rounded head, available with or without side face

3-065-2	120	4 3/4	chrome-plated bright polished, with transparent insulation with side face	1.2	0.4	75
3-066-2	120	4 3/4	without side face	1.2	-	75

Electronics side cutters

for continuous heavy work, with inserted carbid cutting edges, **only** for tough nickel and electrode wires

3-124-1	110	4 3/8	chrome-plated bright polished, with BERNSTEINIT-insulation	-	0.8	70
3-124-2	110	4 3/8	with transparent insulation -		0.8	60
3-067-2	120	4 3/4	with transparent insulation -		1.0	70

Mini side cutters

with extremely narrow, pointed head, without side face, for flush cutting, for precision work, for soft wire only

3-068-2	115	4 1/2	chrome-plated bright polished, with transparent insulation	0.6	-	45
---------	-----	-------	--	-----	---	----

Mini side cutters

with extremely narrow, rounded head, without side face, for flush cutting, for precision work, for soft wire only

3-069-2	115	4 1/2	chrome-plated bright polished, with transparent insulation	0.8	-	45
---------	-----	-------	--	-----	---	----



3-061-2



3-063-2



3-065-2



3-067-2



3-068-2



3-069-2

SPECIAL ELECTRONIC PLIERS

Lap joint
Special steel

(excluding 3-105)



3-105-1

No.	Length		Finish	Cutting capacity mm Ø		Weight g
	mm	Inches		Soft wire	Hard wire	

All-purpose side cutters

small, handy model with excellent cutting capacity for steel wire up to 1.0 mm Ø, lay-on joint

3-105	140	5 1/2	chrome-plated bright polished	2.0	1.0	150
3-105-1	140	5 1/2	with BERNSTEINIT insulation	2.0	1.0	175

Side cutters

with wide, pointed head, special flat cutting edge, compression spring, without side face, for flush cutting, for soft wire only

3-108-2	120	4 3/4	chrome-plated bright polished, with transparent insulation	1.5	-	85
---------	-----	-------	--	-----	---	----

Side cutters

with wide, rounded head, special flat cutting edge, compression spring, without side face, for flush cutting, for soft wire only

3-109-2	120	4 3/4	chrome-plated bright polished, with transparent insulation	1.5	-	90
---------	-----	-------	--	-----	---	----

Side cutters

with slim, pointed head, special flat cutting edge, double leaf spring, without side face, for flush cutting, for soft wire only

3-111-2	120	4 3/4	chrome-plated bright polished, with red insulation	0.8	-	65
---------	-----	-------	--	-----	---	----

Side cutters

with slim, rounded head, double leaf spring, without side face, for flush cutting, for soft wire only

3-112-2	120	4 3/4	chrome-plated bright polished, with red insulation	1.0	-	70
---------	-----	-------	--	-----	---	----

Special side cutters

for plastic, with rounded head, special flat cutting edge, double leaf spring, without side face, for flush cutting of plastic sprues, circuit boards etc.

3-115-2	145	5 3/4	chrome-plated bright polished, with transparent insulation	-	-	120
---------	-----	-------	--	---	---	-----

Side cutters

with especially slim, rounded head, without side face, for flush cutting, for soft wire only

3-126	120	4 3/4	chrome-plated bright polished	1.0	-	60
3-126-1	120	4 3/4	with BERNSTEINIT- insulation	1.0	-	80
3-126-2	120	4 3/4	with transparent insulation	1.0	-	70



3-108-2

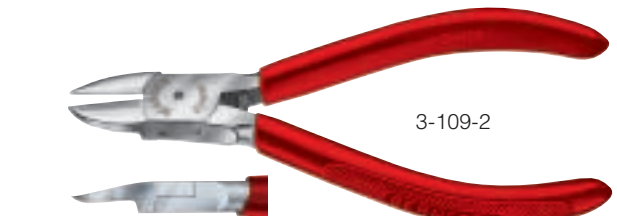

3-109-2

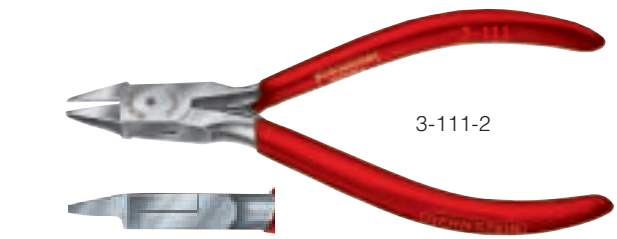

3-111-2

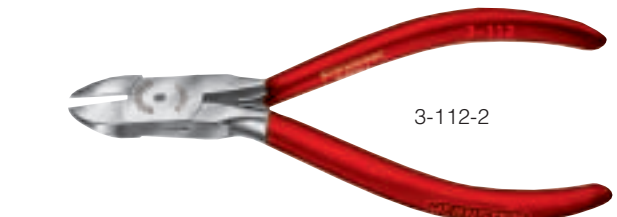

3-112-2

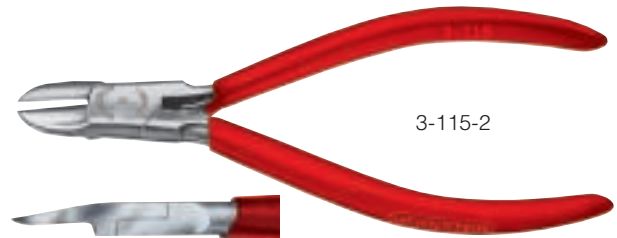

3-115-2



3-126

SPECIAL ELECTRONIC PLIERS

Box joint



Compression spring, Special steel

Especially light and slim

No.	Length		Finish	Cutting capacity mm Ø		Weight g
	mm	inches		Soft wire	Hard wire	
Micro side cutters						
with slim, pointed head and fine side face						
3-125	115	4 1/2	chrome-plated bright polished	0.8	0.3	55
3-125-1	115	4 1/2	with BERNSTEINIT- insulation	0.8	0.3	70
3-125-2	115	4 1/2	with transparent insulation	0.8	0.3	60
Slimline side cutters						
with slim, rounded head and fine side face						
3-127-2	115	4 1/2	chrome-plated bright polished, with transparent insulation	1.0	0.4	60
Slimline side cutters						
with slim, rounded head and fine side face, with wire retaining spring (to hold the wire clippings)						
3-127-2 DR	115	4 1/2	chrome-plated bright polished, with transparent insulation	1.0	0.4	60
Slimline oblique top cutters						
with slim head, without side face, for flush cutting, for soft wire only						
3-128-2	120	4 3/4	chrome-plated bright polished, with transparent insulation	0.8	0.3	65
Slimline top cutters						
with slim head, without side face, for flush cutting, for soft wire only						
3-129-2	115	4 1/2	chrome-plated bright polished, with transparent insulation	1.0	0.4	80
IC top cutters						
for cutting IC connections, without side face						
3-130-2	120	4 3/4	chrome-plated bright polished, with transparent insulation	-	-	65
Slimline end cutters						
with angular tip and oblique cutting edge, without side face, for flush cutting, for precision work at points difficult to reach, for soft wire only						
3-164-2	140	5 1/2	chrome-plated bright polished, with transparent insulation	0.8	-	80
End cutters						
with angular tip and cutting edge, without compression spring, for soft wire only						
3-165	165	6 1/2	chrome-plated	1.0	-	95
3-165-1	165	6 1/2	with BERNSTEINIT- insulation	1.0	-	115
3-165-2	165	6 1/2	with transparent insulation	1.0	-	105



3-125-2



3-127-2



3-127-2 DR



3-128-2



3-129-2



3-130-2



3-164-2



3-165-1

SPECIAL ELECTRONIC PLIERS

Box joint 

Compression spring, Special steel



3-161-2



3-162-2



3-172-2



3-175-2



3-056-2

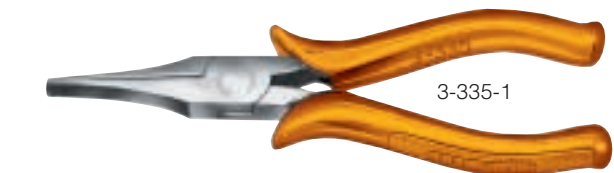

3-335-1

No.	mm	Length inches	Finish	Weight g
-----	----	------------------	--------	-------------

Snipe nose pliers

with wire cutter for soft wire up to 0.6 mm Ø, particularly slim, pointed model with fine serrated jaws

3-161-2	145	5 3/4	chrome-plated, polished, with transparent insulation	75
---------	-----	-------	--	----

Telephone pliers

with wire cutter for soft wire up to 0.8 mm Ø, especially slim, pointed model with fine serrated jaws

3-162-2	150	6	chrome-plated, polished, with transparent insulation	75
---------	-----	---	--	----

COMPONENT PLIERS

For bending, cutting and squeezing connecting wires on components

Crimping and bending pliers

crimp the wire in one operation without changing the parallelism of the ends of the wire, especially slim model

3-172-2	130	5 1/8	chrome-plated, polished, with transparent insulation	75
---------	-----	-------	--	----

Cutting and squeezing pliers

cut and squeeze soft wire up to 1.2 mm Ø in one operation, wire ends are shortened up to 1.5 mm and squeezed flat, cutting edge width 4.0 mm

3-175-2	125	5	chrome-plated, polished, with transparent insulation	70
---------	-----	---	--	----

Cutting and bending pliers

cut and bend soft wire up to 0.8 mm Ø in one operation, wire ends are shortened to 1.5 mm and bent through 45°, cutting edge width 2.0 mm, especially slim model

3-056-2	125	5	chrome-plated, polished, with transparent insulation	75
---------	-----	---	--	----

ADJUSTING PLIERS

Lap joint 

Special steel

Produced accurately, extremely resilient

Adjusting pliers bent at right angles

3-315	135	5 1/2	chrome-plated, polished,	70
3-315-1	135	5 1/2	with BERNSTEINIT-insulation	85

Adjusting pliers bent at an obtuse angle

3-325	135	5 1/2	chrome-plated, polished,	70
3-325-1	135	5 1/2	with BERNSTEINIT-insulation	85

Adjusting pliers straight, flat and wide

3-335	135	5 1/2	chrome-plated, polished,	70
3-335-1	135	5 1/2	with BERNSTEINIT-insulation	85

Adjusting pliers straight, pointed nose

3-345	135	5 1/2	chrome-plated, polished,	70
3-345-1	135	5 1/2	with BERNSTEINIT-insulation	85



3-315



3-325



3-345

SPECIAL ELECTRONIC PLIERS

Box joint



Special steel

Especially light and slim

Plain jaws

No.	Length		Finish	Weight g
	mm	inches		

Micro round nose pliers

extremely light and slim

3-435	120	4 3/4	chrome-plated, bright polished	40
3-435-2	120	4 3/4	with transparent insulation	45

Micro flat nose pliers

extremely light and slim

3-445	120	4 3/4	chrome-plated, bright polished	45
3-445-2	120	4 3/4	with transparent insulation	50

Micro snipe nose pliers

extremely light and slim

3-455	120	4 3/4	chrome-plated, bright polished	45
3-455-2	120	4 3/4	with transparent insulation	50

Round nose pliers

slim model, with compression spring

			chrome-plated, bright polished, with transparent insulation	
3-461-2	130	5 1/8	short jaws	70
3-471-2	145	5 3/4	long jaws	70

Flat nose pliers

slim model, with compression spring

			chrome-plated, bright polished, with transparent insulation	
3-462-2	130	5 1/8	short jaws	80
3-472-2	145	5 3/4	long jaws	80

Snipe nose pliers

slim model, with compression spring

			chrome-plated, bright polished, with transparent insulation	
3-463-2	130	5 1/8	short jaws	75
3-473-2	145	5 3/4	long jaws	85

Snipe nose pliers

angular, slim model, with compression spring

			chrome-plated, bright polished, with transparent insulation	
3-481-2	130	5 1/8	short jaws	50
3-482-2	140	5 1/2	long jaws	80



3-435-2



3-445-2



3-455-2



3-461-2



3-472-2



3-473-2



3-482-2

SIDE CUTTERS

Lap joint, lay-on joint or box joint

Special steel



3-132-1

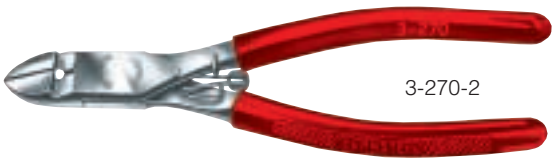

3-270-2



3-138-2



3-141-1



3-151-2



3-152-1

No.	Length		Finish	Cutting capacity mm Ø		Weight g
	mm	Inches		Soft wire	Hard wire	

Side cutters

swedish design, lap joint, special steel

3-131	120	4 3/4	chrome-plated, polished	1.5	0.8	90
3-131-1	120	4 3/4	with BERNSTEINIT-ins.	1.5	0.8	110
3-132	130	5 1/8	chrome-plated, polished	2.0	1.0	110
3-132-1	130	5 1/8	with BERNSTEINIT-ins.	2.0	1.0	130
3-133	145	5 3/4	chrome-plated, polished	2.5	1.25	120
3-133-1	145	5 3/4	with BERNSTEINIT-ins.	2.5	1.25	160

Electronic side cutters

slim model, with long handles, lay-on joint, special steel, with expanding spring

3-270-2	130	5 1/8	chrome-plated bright polished, with transparent insulation	1.0	0.5	70
---------	-----	-------	--	-----	-----	----

Special side cutters

slim, pointed head, box joint, compression spring, special steel, without side face, for flush cutting, for soft wire only

3-138	130	5 1/8	chrome-plated, polished	1.25	-	85
3-138-2	130	5 1/8	with transparent insulation	1.25	-	90

Power side cutters

powerful, handy model, with excellent cutting capacity for steel wire, lay-on joint, special steel

3-141	145	5 3/4	chrome-plated, polished	2.5	1.25	150
3-141-1	145	5 3/4	with BERNSTEINIT-ins.	2.5	1.25	180
3-142	160	6 1/4	chrome-plated, polished	3.0	1.5	210
3-142-1	160	6 1/4	with BERNSTEINIT-ins.	3.0	1.5	245

TOP CUTTERS

Top cutters

small, handy model, lap joint, special steel

3-151	120	4 3/4	chrome-plated, polished	2.0	1.0	85
3-151-1	120	4 3/4	with BERNSTEINIT-ins.	2.0	1.0	110
3-151-2	120	4 3/4	with transparent ins.	2.0	1.0	90

Top cutters

powerful, handy model, lay-on joint, special steel

3-152	130	5 1/8	chrome-plated, polished	2.5	1.25	125
3-152-1	130	5 1/8	with BERNSTEINIT-ins.	2.5	1.25	150
3-153	160	6 1/4	chrome-plated, polished	3.0	1.6	200
3-153-1	160	6 1/4	with BERNSTEINIT-ins.	3.0	1.6	230

ENGINEER'S PLIERS

Box joint  Special steel
Fine, slim design, with fine serrated jaws

No.	Length mm	inches	Finish	Weight g
Long nose pliers flat, slim				
3-205	185	7 1/2	chrome-plated, polished	120
3-205-1	185	7 1/2	with BERNSTEINIT-insulation	140

Snipe long nose pliers oval-pointed, bent

3-215	185	7 1/2	chrome-plated, polished	125
3-215-1	185	7 1/2	with BERNSTEINIT-insulation	145

Snipe nose pliers oval-pointed

3-225	130	5 1/8	chrome-plated, polished	65
3-225-1	130	5 1/8	with BERNSTEINIT-insulation	80

TELEPHONE PLIERS

Lap joint  Special steel
Serrated jaws Wire cutters

Telephone pliers snipe nose,
short jaws, with cutting edge for hard wire

3-235	145	5 3/4	chrome-plated, polished	95
3-235-1	145	5 3/4	with BERNSTEINIT-insulation	115

Telephone pliers snipe nose, long
straight jaws, with cutting edge for hard wire

3-245	200	8	chrome-plated, polished	160
3-245-1	200	8	with BERNSTEINIT-insulation	190

Telephone pliers snipe nose,
long bent jaws, with cutting edge for hard wire

3-255	200	8	chrome-plated, polished	160
3-255-1	200	8	with BERNSTEINIT-insulation	190

FLAT AND ROUND NOSE PLIERS

Lap joint  Special steel
Serrated jaws

Flat nose pliers with short jaws

3-511	120	4 3/4	chrome-plated, polished	70
3-511-1	120	4 3/4	with BERNSTEINIT-insulation	85
3-512	140	5 1/2	chrome-plated, polished	105
3-512-1	140	5 1/2	with BERNSTEINIT-insulation	125

Round nose pliers with short jaws

3-521	120	4 3/4	chrome-plated, polished	65
3-521-1	120	4 3/4	with BERNSTEINIT-insulation	80
3-522	140	5 1/2	chrome-plated, polished	110
3-522-1	140	5 1/2	with BERNSTEINIT-insulation	130

Flat nose pliers with long jaws

3-531	140	5 1/2	chrome-plated	90
3-531-1	140	5 1/2	with BERNSTEINIT-insulation	110
3-532	160	6 1/4	chrome-plated	140
3-532-1	160	6 1/4	with BERNSTEINIT-insulation	160



3-205-1



3-215-1



3-225-1



3-235-1



3-245-1



3-255-1

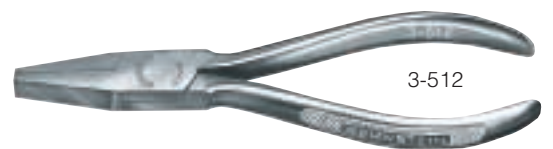

3-512



3-522-1



3-531

COMBINATION PLIERS



3-732-1



3-742-1



3-565-1



3-575-6



3-578-6



3-385



3-761-10



3-771-10

No.	Length		Finish	Weight g
	mm	inches		

Combination pliers with wire cutter, for hard wire

3-715	115	4 1/2	chrome-plated, polished	70
3-715-1	115	4 1/2	with BERNSTEINIT-insulation	90
3-731	140	5 1/2	chrome-plated, polished	135
3-731-1	140	5 1/2	with BERNSTEINIT-insulation	155
3-732	165	6 1/2	chrome-plated, polished	190
3-732-1	165	6 1/2	with BERNSTEINIT-insulation	220
3-733	180	7	chrome-plated, polished	225
3-733-1	180	7	with BERNSTEINIT-insulation	260

Electrician's combination pliers, extra quality

chrome-vanadium steel, with wire cutter for piano wire

cutting capacity: No. 3-742 up to 1.6 mm Ø

No. 3-743 up to 2.0 mm Ø

3-742	160	6 1/4	chrome-plated, polished	185
3-742-1	160	6 1/4	with BERNSTEINIT-insulation	215
3-743	180	7	chrome-plated, polished	250
3-743-1	180	7	with BERNSTEINIT-insulation	285

WATER PUMP PLIERS

Miniature water pump pliers with 3 adjustments

3-565	130	5 1/8	chrome-plated, polished	85
3-565-1	130	5 1/8	with BERNSTEINIT-insulation	105

Water pump pliers

3-575-6	240	9 1/2	nickel-plated with red insulation	360
---------	-----	-------	--------------------------------------	-----

Siphon pliers chrome-vanadium steel, opening up to 70 mm

3-578-6	240	9 1/2	nickel-plated with red insulation	360
---------	-----	-------	--------------------------------------	-----

Quick-action water pump pliers

chrome-vanadium steel, toothed box joint,
excellent design with extremely high stability

3-585	175	7	chrome-plated, polished	165
3-585-1	175	7	with BERNSTEINIT-insulation	185
3-586	250	10	chrome-plated, polished	470
3-586-1	250	10	with BERNSTEINIT-insulation	505

SPECIAL ASSEMBLY PLIERS

No.	Length		for clamping rings	Finish	Weight g
	mm	inches			

Model with adjusting screw and sprung handles

for clamping rings on shafts without grooves

3-761-10	140	5 1/2	1.5-2.8 mm	fine burnished	90
----------	-----	-------	------------	----------------	----

Model with cylindrical tips (for bores)

for fitting internal circlips to DIN 472, 984 etc.

for circlips Bore-Ø					
3-771-10	140	5 1/2	8-25 mm	burnished, straight	90
3-772-10	130	5 1/8	8-25 mm	burnished, offset	90

Model with cylindrical tips, sprung handles (for shafts)

for fitting external circlips to DIN 471, 983 etc..

for circlips Shaft-Ø					
3-781-10	140	5 1/2	3-10 mm	burnished, straight	90
3-782-10	140	5 1/2	10-25 mm	burnished, straight	90
3-783-10	135	5 1/4	3-10 mm	burnished, offset	90
3-784-10	135	5 1/4	10-25 mm	burnished, offset	90

WIRE STRIPPERS

Lap joint
Special steel



No.	Length mm	inches	Finish	Weight g
"Record" wire strippers				
Spring system enables safe working with automatic adjustment to the wire size. Easy to use: insert wire - close pliers - remove insulation				
3-805-4	160	6 1/4	for wire thicknesses from 0.5 to 5 mm Ø nickel-plated with BERNSTEINIT-insulation	175
3-806-4	160	6 1/4	for wire thicknesses from 0.3 to 1.2 mm Ø nickel-plated with BERNSTEINIT-insulation	175

Wire strippers with adjusting screw

for all wire thicknesses, with compression spring

3-815	155	6 1/8	chrome-plated, polished	130
3-815-1	155	6 1/8	with BERNSTEINIT-insulation	165

Wire strippers for use in electronics

especially narrow and slim, with internal adjusting screw and compression spring

3-834-2	135	5 1/2	chrome-plated, polished with transparent insulation	85
3-835-2	160	6 1/4	chrome-plated, polished with transparent insulation	120

PRESSING PLIERS

Lay-on joint
Carbon steel



Pressing pliers for multicore cable end

combined with cable cutter and stripping-prism for different cable dimensions for sleeves of 0.25 - 2.5 mm².

3-871-6	155	6	nickel-plated, with red insulation	160
---------	-----	---	------------------------------------	-----

Pressing pliers for multicore cable end

combined with cable cutter and stripping-prism for different cable dimensions for sleeves of 0.50 - 16.0 mm².

3-875-6	225	9	nickel-plated, with red insulation	285
---------	-----	---	------------------------------------	-----

SETS OF ELECTRONICS PLIERS

in wallets of recycable nylon

Contents: Black burnished pliers, with orange insulation

3-940 Set consisting of 4 pliers

No.	Description of individual tools	Weight: 350 g
3-901-12	Side cutters , 120 mm, for soft wire up to 1.0 mm, for hard wire up to 0.4 mm Ø	
3-906-12	End cutters , 125 mm, with angular tips and oblique cutting edge, without side face, for flush cutting, for soft wire only up to 0.8 mm Ø	
3-932-12	Flat nose pliers , 120 mm	
3-933-12	Snipe nose pliers , 125 mm	

3-930 Set consisting of 3 pliers

No.	Description of individual tools	Weight: 275 g
3-901-12	Side cutters , 120 mm, for soft wire up to 1.0 mm, for hard wire up to 0.4 mm Ø	
3-932-12	Flat nose pliers , 120 mm	
3-933-12	Snipe nose pliers , 125 mm	



3-805-4



3-815



3-834-2



3-871-6



3-875-6



SPECIAL ELECTRONIC PLIERS

Black burnished
Lap joint
Double leaf spring



CUTTING PLIERS

No.	Length		Finish	Cutting capacity mm Ø		Weight g
	mm	inches		Soft wire	Hard wire	

Side cutters

with slim, rounded head

3-901-12	120	4 3/4	burnished orange insulation	1.0	0.4	70
----------	-----	-------	--------------------------------	-----	-----	----

Side cutters

with slim, pointed head, special flat cutting edge, for soft wire only

3-902-12	120	4 3/4	burnished orange insulation	0.8	-	70
----------	-----	-------	--------------------------------	-----	---	----

Top cutters

with 3 mm wide cutting edge, jaw length 20 mm, without side face, for flush cutting, for soft wire only

3-905-12	125	5	burnished orange insulation	0.8	-	70
----------	-----	---	--------------------------------	-----	---	----

End cutters

with angular tips and oblique cutting edge, without side face, for flush cutting, for soft wire only

3-906-12	125	5	burnished orange insulation	0.8	-	75
----------	-----	---	--------------------------------	-----	---	----

ROUND-FLAT-SNIPE NOSE PLIERS

No.	Length		Finish	Weight g
	mm	inches		

Round nose pliers

with short, plain jaws

3-931-12	120	4 3/4	burnished orange insulation	70
----------	-----	-------	--------------------------------	----

Flat nose pliers

with short, plain jaws

3-932-12	120	4 3/4	burnished orange insulation	75
----------	-----	-------	--------------------------------	----

Flat nose pliers

slim model, with long, serrated jaws

3-942-12	145	5 3/4	burnished orange insulation	90
----------	-----	-------	--------------------------------	----

Snipe nose pliers

with short, plain jaws

3-933-12	125	5	burnished orange insulation	70
----------	-----	---	--------------------------------	----

Snipe nose pliers

slim model, with long, serrated jaws

3-943-12	145	5 3/4	burnished orange insulation	85
----------	-----	-------	--------------------------------	----

Snipe nose pliers

angular, slim model, with long, serrated jaws

3-945-12	145	5 3/4	burnished orange insulation	85
----------	-----	-------	--------------------------------	----



3-901-12



3-902-12

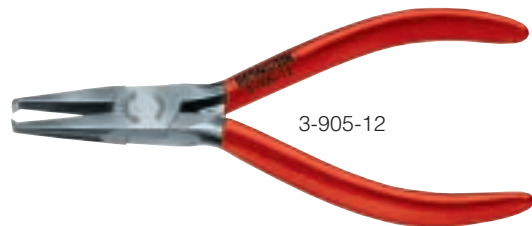

3-905-12

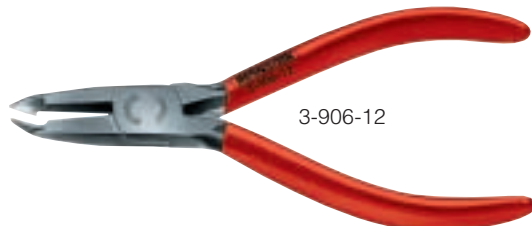

3-906-12

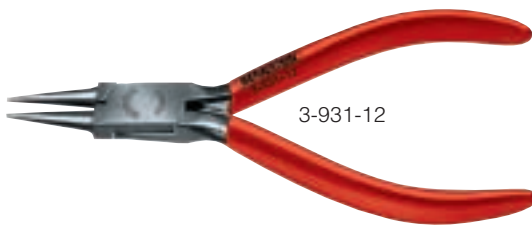

3-931-12

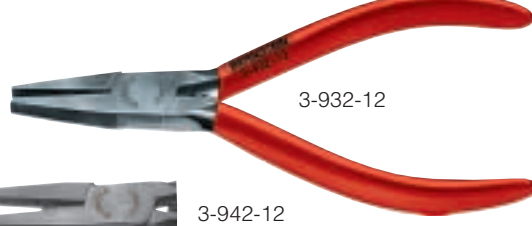

3-932-12

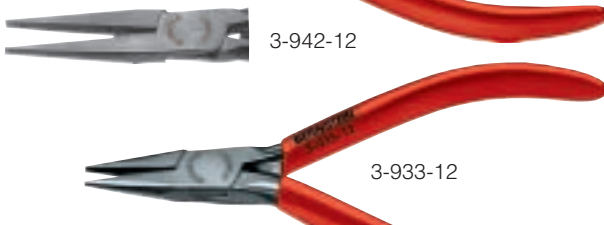

3-942-12

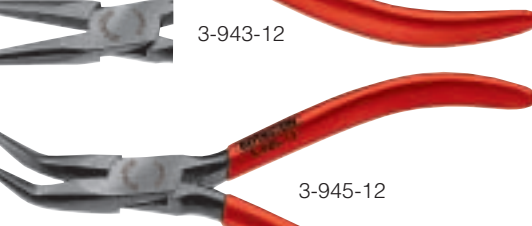

3-933-12

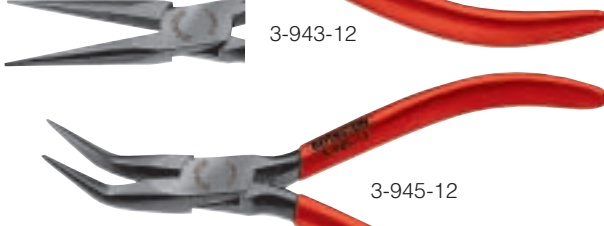

3-943-12



3-945-12

SPECIAL ELECTRONIC PLIERS

Bright steel polished
Box joint
Double leaf spring



CUTTING PLIERS

No.	Length		Finish	Cutting capacity mm Ø		Weight g
	mm	inches		Soft wire	Hard wire	
Side cutters						
with slim, rounded head, available with or without side face						
			bright steel-polished with red hand-guard			
3-601-8	120	4 3/4	with side face	1.0	0.4	70
3-602-8	120	4 3/4	without side face	1.0	-	70

Side cutters						
with slim, pointed head, available with or without side face						
			bright steel-polished with red hand-guard			
3-603-8	120	4 3/4	with side face	0.8	0.3	70
3-604-8	120	4 3/4	without side face	0.8	-	70

End cutters						
with angular tips and oblique cutting edge, without side face, for flush cutting, for soft wire only						
			bright steel-polished with red hand-guard			
3-606-8	120	4 3/4	without side face	0.8	-	60

ROUND-FLAT-SNIPE NOSE PLIERS

No.	Length mm	Length inches	Finish	Weight g
Round nose pliers with plain jaws				
3-631-8	120	4 3/4	bright steel-polished with red hand-guard	60

Flat nose pliers with plain jaws				
3-632-8	120	4 3/4	bright steel-polished with red hand-guard	60

Snipe nose pliers with plain jaws				
3-633-8	120	4 3/4	bright steel-polished with red hand-guard	60

Snipe nose pliers angular, with plain jaws				
3-634-8	120	4 3/4	bright steel-polished with red hand-guard	60

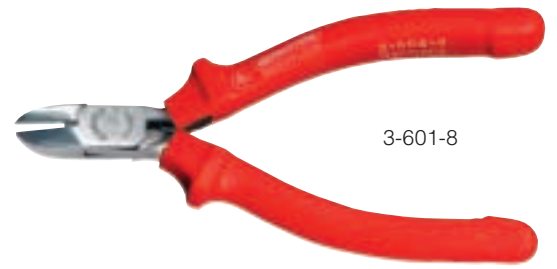

3-601-8

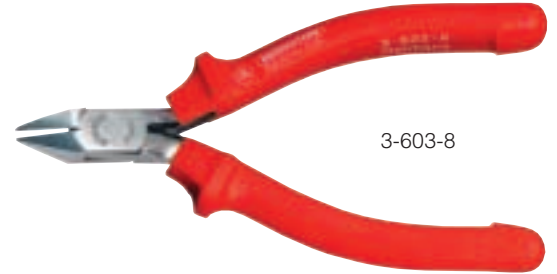

3-603-8

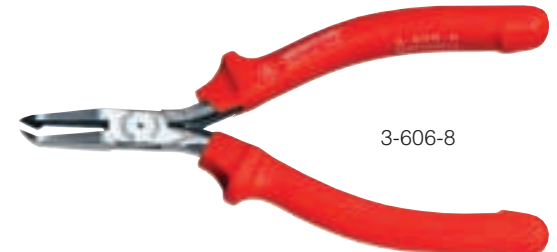

3-606-8

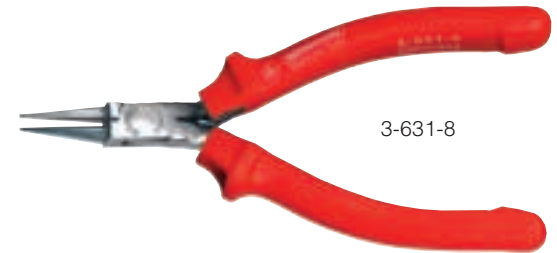

3-631-8

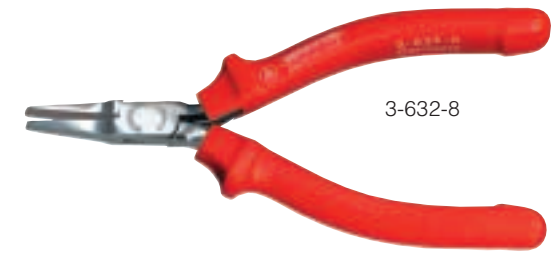

3-632-8

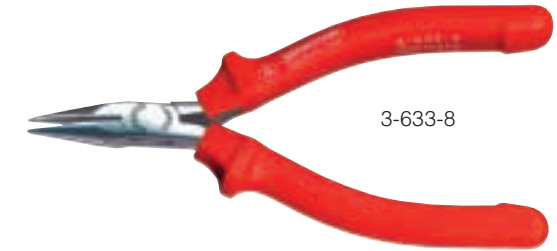

3-633-8

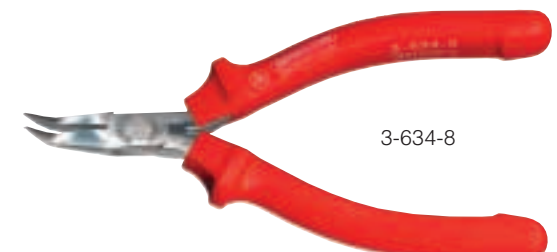

3-634-8



SAFETY INSULATED PLIERS

Produced in accordance with specification EN 60.900 of the Association of German Electrical Engineers (VDE).

Permissible voltage at which the VDE pliers can be used: 1000 V a.c. or 1500 V d.c.

The guarantee of optimum safety

No.	mm	Length inches	Finish	Weight g
-----	----	------------------	--------	-------------

Side cutters

for steel wire up to 1.6 mm Ø, swedish design, special steel

3-134 VDE	160	6 1/4	chrome-plated, polished, with VDE safety insulation	265
-----------	-----	-------	---	-----

Power side cutters

for steel wire up to 1.6 mm Ø, special steel

3-142 VDE	170	6 3/4	chrome-plated, polished, with VDE safety insulation	265
-----------	-----	-------	---	-----

Telephone pliers

snipe nose, long, straight jaws, with cutting edge for hard wire, serrated jaws, special steel

3-244 VDE	165	6 1/2	chrome-plated, polished, with VDE safety insulation	175
3-245 VDE	205	8	chrome-plated, polished, with VDE safety insulation	235

Telephone pliers

snipe nose, long, bent jaws, with cutting edge for hard wire, serrated jaws, special steel

3-254 VDE	165	6 1/2	chrome-plated, polished, with VDE safety insulation	175
3-255 VDE	205	8	chrome-plated, polished, with VDE safety insulation	235

Round nose pliers

with long, round, serrated jaws

3-541 VDE	185	7 1/4	chrome-plated, polished, with VDE safety insulation	230
-----------	-----	-------	---	-----

Flat nose pliers

with long, flat, serrated jaws

3-545 VDE	185	7 1/4	chrome-plated, polished, with VDE safety insulation	235
-----------	-----	-------	---	-----

Combination pliers

with wire cutter, for hard wire up to 1.6 mm Ø

3-732 VDE	170	6 3/4	chrome-plated, polished, with VDE safety insulation	230
3-733 VDE	185	7 1/4	chrome-plated, polished, with VDE safety insulation	290

„Record“ wire strippers

with automatic adjusting to the wire size, for wire thicknesses from 0.5 to 5 mm Ø

3-805 VDE	165	6 1/2	chrome-plated, polished, with VDE safety insulation	195
-----------	-----	-------	---	-----

Wire strippers

with adjusting screw

3-815 VDE	160	6 1/4	chrome-plated, polished, with VDE safety insulation	180
-----------	-----	-------	---	-----

SAFETY INSULATED PLIERS

Insulated and piece-checked in accordance with specification EN 60.900 of the Association of German Electrical Engineers (VDE) Permissible voltage at which the VDE pliers can be used: 1000 V a.c. or 1500 V d.c.

 1000 V **EN 60.900**

No.	Length mm	Zoll	Finish	Weight g
-----	--------------	------	--------	-------------

Side cutters

Special steel, cutting capacity: 13-906 VDE for steel wire up to 1.6 mm Ø
13-908 VDE for steel wire up to 2.0 mm Ø

13-906 VDE	160	6 1/4	chrome-plated, polished, with safety insulation	210
13-908 VDE	180	7	chrome-plated, polished, with safety insulation	290

Telephon pliers

snipe nose, long, straight jaws, with cutting edge for hard wire up to 1.6 mm Ø, serrated jaws, special steel

13-915 VDE	160	6 1/4	chrome-plated, polished, with safety insulation	155
13-917 VDE	200	8	chrome-plated, polished, with safety insulation	220

Telephon pliers

snipe nose, long, bent jaws, with cutting edge for hard wire up to 1.6 mm Ø, serrated jaws, special steel

13-916 VDE	160	6 1/4	chrome-plated, polished, with safety insulation	150
13-918 VDE	200	8	chrome-plated, polished, with safety insulation	220

Round nose pliers

with long, round, serrated jaws

13-926 VDE	160	6 1/4	chrome-plated, polished, with safety insulation	165
------------	-----	-------	--	-----

Flat nose pliers

with long, flat, serrated jaws

13-927 VDE	160	6 1/4	chrome-plated, polished, with safety insulation	180
------------	-----	-------	--	-----

Combination pliers

with wire cutter for hard wire up to 1.6 mm Ø

13-936 VDE	160	6 1/4	chrome-plated, polished, with safety insulation	220
13-937 VDE	185	7 1/4	chrome-plated, polished, with safety insulation	280
13-938 VDE	205	8	chrome-plated, polished, with safety insulation	350

Wire strippers

with adjusting screw

13-946 VDE	160	6 1/4	chrome-plated, polished, with safety insulation	190
------------	-----	-------	--	-----

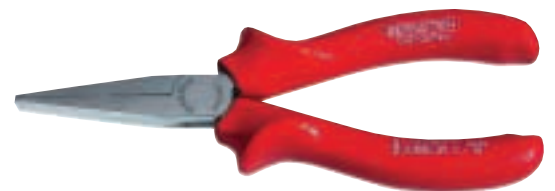



SAFETY INSULATED PLIERS

Insulated and piece-checked in accordance with specification EN 60.900 of the Association of German Electrical Engineers (VDE). Permissible voltage at which the safety pliers can be used: 1000 V a.c. or 1500 V d.c. Two-colour multilayered insulation, outside red - inside yellow. Damages of the external red insulation immediately become visible by the yellow layer below.

The advantage: simple safety control, practical at any time



13-106 VDE



13-207 VDE



13-506 VDE



13-516 VDE



13-707 VDE



13-806 VDE

No.	Length mm	Length inches	Finish	Weight g
-----	--------------	------------------	--------	-------------

Side cutters

special steel, cutting capacity: 13-106 VDE for steel wire up to 1.6 mm Ø
13-108 VDE for steel wire up to 2.0 mm Ø

13-106 VDE	160	6 1/4	chrome-plated, polished, with VDE safety insulation	210
13-108 VDE	195	7 3/4	chrome-plated, polished, with VDE safety insulation	300

Telephone pliers

snipe nose, long, straight jaws, with cutting edge for hard wire up to 1.6 mm Ø, serrated jaws, special steel

13-207 VDE	205	8	chrome-plated, polished, with VDE safety insulation	235
------------	-----	---	--	-----

Telephone pliers

snipe nose, long, bent jaws, with cutting edge for hard wire up to 1.6 mm Ø, serrated jaws, special steel

13-208 VDE	205	8	chrome-plated, polished, with VDE safety insulation	235
------------	-----	---	--	-----

Round nose pliers

with long, round, serrated jaws

13-506 VDE	165	6 1/2	chrome-plated, polished, with safety insulation	225
------------	-----	-------	--	-----

Flat nose pliers

with long, flat, serrated jaws

13-516 VDE	165	6 1/2	chrome-plated, polished, with safety insulation	185
------------	-----	-------	--	-----

Combination pliers

with wire cutter, for hard wire up to 1.6 mm Ø

13-707 VDE	190	7 1/2	chrome-plated, polished, with VDE safety insulation	300
13-708 VDE	210	8 1/4	chrome-plated, polished, with VDE safety insulation	365

Wire strippers

with adjusting screw

13-806 VDE	165	6 1/2	chrome-plated, polished, with VDE safety insulation	210
------------	-----	-------	--	-----

CRIMPING PLIERS FOR MODULAR CONNECTORS

No.	mm	Length inches	for connector types	Weight g
-----	----	------------------	---------------------	-------------

Crimping pliers

solid metal type, with interchangeable blades, spring and closed lock, for cutting, cable stripping and crimping of the most current connector types

3-0601	190	7 1/2	4P/4C, 4P/2C	215
3-0602	190	7 1/2	6P/6C, 6P/4C, 6P/2C	215
3-0603	200	8	8P/8C	270

Combination crimping pliers

solid metal pliers, with interchangeable blades, spring and closed lock, for cutting, cable stripping and crimping

3-0605	200	8	6P/6C, 6P/4C, 6P/2C, 8P/8C	320
--------	-----	---	-------------------------------	-----

Universal crimping pliers

light execution, ergonomically formed plastic casing, for cutting, cable stripping and crimping

3-0608	205	8 1/4	4P/4C, 4P/2C, 6P/6C, 6P/4C, 6P/2C, 8P/8C, 8P/6C, 8P/4C, 8P/2C	160
--------	-----	-------	--	-----

Crimping pliers

for BNC- and TNC-coaxial connectors, with forced locking device and automatic release, for inner contacts and outside sleeves

Pressing range	Crimping length	Inner-Ø
Hexagon for all inner contacts	2.3 mm	.068" 1.72 mm
Small hexagon for RG 58	10.0 mm	.213" 5.41 mm
Medium-sized hexagon for RG 59/62	10.0 mm	.256" 6.50 mm
Large hexagon RG 6	10.0 mm	.319" 8.10 mm

No.	mm	Length inches	Finish	Weight g
3-0611	220	8 3/4	burnished-insulated	480

Crimp tool

for insulated and uninsulated terminals

3-0856	230	9 1/4	black-insulated	295
--------	-----	-------	-----------------	-----

CUTTING TOOLS

No.	mm	Length inches	Finish	Weight g
-----	----	------------------	--------	-------------

Cabel cutters

especially for coaxial cable, robust execution with closed lock, for cable up to 10.5 mm Ø

3-0648	160	6 1/4	burnished-insulated	150
--------	-----	-------	---------------------	-----

Electronics side cutters

with spring, without side face, for CU-wires up to 1.0 mm Ø

3-0641	130	5 1/8	burnished-insulated	70
--------	-----	-------	---------------------	----

Stripping side cutters

standard-execution, with spring, without side face, for CU-wires up to 0.8 mm Ø

3-0645	125	5	burnished-insulated	60
--------	-----	---	---------------------	----

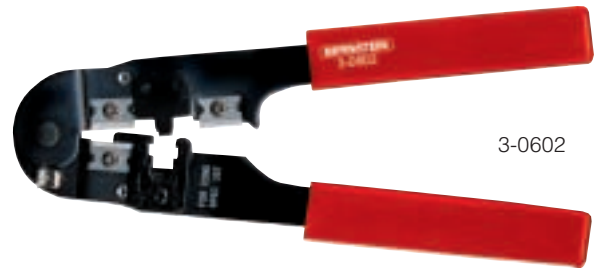

3-0602



3-0605



3-0608



3-0611



3-0856



3-0648



3-0641



3-0645



BERNSTEIN

Electronic-Tools

Quality for the specialist



BERNSTEIN screwdrivers and wrenches with special square pattern Bernstein handle

Special features:

long square pattern handle, very shape, with tapered hexagon at the end

Material:

impact resistant transparent plastic

Colour:

amber



BERNSTEIN screwdrivers with EUROline-Power-handle

Special features:

ergonomically formed hexagon handle with slip off protection for sturdy and safety screwing

Material:

combined hard- and soft plastic

Colour:

grey-yellow

SCREWDRIVERS

with special square pattern Bernstein handle
from impact-resistant, transparent yellow plastic

Engineer's screwdrivers

Blade: chrome vanadium, hardened over its full length, chrome-plated

No.	Blade length mm	Blade width mm	Blade thickness mm	Handle size mm	Weight
4-102 S	75	3.5	0.6	86 x 19	37 g
4-103 S	100	4.0	0.6	92 x 21	46 g
4-104 S	150	5.0	0.8	100 x 23	75 g
4-105 S	200	6.0	1.0	110 x 25	112 g
4-115 S	200	3.0	0.5	86 x 19	40 g
4-125 S	100	6.0	1.0	110 x 25	90 g
4-135 S	150	8.0	1.2	110 x 25	133 g

Screwdrivers to DIN 5265

Blade: chrome vanadium, hardened over its full length, chrome-plated, black tip

No.	Blade length mm	Blade width mm	Blade thickness mm	Handle size mm	Weight
4-141	75	3.5	0.6	86 x 19	35 g
4-142	100	4.0	0.8	92 x 21	46 g
4-143	125	5.5	1.0	100 x 23	75 g
4-144	150	6.5	1.2	110 x 25	110 g
4-145	150	8.0	1.2	110 x 25	144 g

Swiss standard screwdrivers

Blade: chrome vanadium, hardened over its full length, chrome-plated, black tip

No.	Size	Blade length mm	Blade width mm	Blade thickness mm	Handle size mm	Weight
4-151	0	80	2.5	0.4	86 x 19	30 g
4-152	1	90	3.5	0.5	86 x 19	35 g
4-153	2	100	4.0	0.6	92 x 21	46 g
4-154	3	120	5.5	0.8	100 x 23	70 g
4-155	4	140	6.5	1.0	110 x 25	100 g
4-156	5	160	8.0	1.2	110 x 25	120 g
4-157	6	180	10.0	1.6	110 x 25	150 g

Cross-recess screwdrivers

Blade: chrome vanadium, hardened over its full length, chrome-plated, black tip

No.	Size	Blade length mm	Blade-Ø mm	Handle size mm	Weight
4-255	0	60	3.0	86 x 19	25 g
4-256	1	80	4.5	92 x 21	49 g
4-257	2	100	6.0	100 x 23	78 g
4-258	3	150	8.0	110 x 25	137 g

Cross-recess screwdrivers Pozidriv

Blade: chrome vanadium, hardened over its full length, chrome-plated, black tip

No.	Size	Blade length mm	Blade-Ø mm	Handle size mm	Weight
4-271	0	60	3.0	86 x 19	25 g
4-272	1	80	4.5	92 x 21	49 g
4-273	2	100	6.0	100 x 23	78 g
4-274	3	150	8.0	110 x 25	140 g

Very long screwdrivers

Blade: chrome vanadium, hardened over its full length, chrome-plated, black tip

No.	Blade length mm	Blade width mm	Blade thickness mm	Handle size mm	Weight
4-222	260	3.0	0.5	92 x 21	50 g
4-223	260	4.5	1.0	92 x 21	70 g
4-224	300	5.5	1.2	100 x 23	108 g

Cross-recess screwdrivers

4-227	300	size 1	blade Ø 4.5	100 x 23	87 g
4-228	300	size 2	blade Ø 6.0	100 x 23	120 g
4-229	300	size 3	blade Ø 8.0	110 x 25	190 g

All screwdrivers can be supplied with insulated blades.
In this case the article number gets the suffix "-1".



SCREWDRIVERS

Cross-recess screwdrivers

Blade: chrome vanadium, hardened over its full length, nickel-plated

Handle: impact-resistant, transparent plastic

No.	Size	Blade length mm	Blade-Ø mm	Handle size mm	Weight
4-251	0	60	3.0	80 x 16	20 g
4-252	1	80	4.5	90 x 18	36 g
4-253	2	100	6.0	98 x 21	60 g
4-254	3	150	8.0	103 x 24	125 g
4-261	01	25	4.5	50 x 29	43 g
4-262	02	25	6.0	55 x 30	46 g

Electrician's screwdrivers

Blade: chrome vanadium, plane-parallel, hardened over its full length, nickel-plated

Handle: impact-resistant, transparent yellow plastic

No.	Blade length mm	Blade width mm	Blade thickness mm	Handle size mm	Weight
4-201	75	3.0	0.4	80 x 16	21 g
4-202	100	3.0	0.4	80 x 16	23 g
4-203	150	3.0	0.4	90 x 18	31 g
4-204	100	4.0	0.5	90 x 18	34 g
4-205	150	4.0	0.6	98 x 21	49 g
4-206	150	5.0	0.8	98 x 21	58 g
4-207	200	5.0	0.8	98 x 21	66 g

Chubby screwdrivers

Blade: chrome vanadium, nickel-plated

Handle: impact-resistant, transparent plastic

4-321	25	4.0	0.8	55 x 30	41 g
4-322	25	6.5	1.2	55 x 30	46 g

Miniature screwdriver

Blade: special steel, nickel-plated

Handle: transparent yellow plastic

4-301	40	1.8	0.5	45 x 9	3 g
-------	----	-----	-----	--------	-----

Screwdriver for grub screws

Blade: chrome vanadium, plane-parallel, nickel-plated

Handle: impact-resistant, transparent yellow plastic

4-311	80	2.8	0.6	60 x 11	10 g
-------	----	-----	-----	---------	------

Radio screwdrivers

Blade: chrome vanadium, nickel-plated

Handle: transparent yellow plastic

4-315	40	3.0	0.8	60 x 11	8 g
4-316	60	3.0	0.8	60 x 11	9 g
4-317	80	3.0	0.8	60 x 11	10 g

Mechanic's screwdriver

Blade: special steel, nickel-plated

Handle: impact-resistant, transparent plastic

4-331	45	6.0	1.0	80 x 16	26 g
-------	----	-----	-----	---------	------

Special screwdriver for cabinet screws

Blade: special steel, chrome-plated

Handle: impact-resistant, transparent yellow plastic

4-335	70	9.0	1.0	92 x 21	43 g
-------	----	-----	-----	---------	------

Screwdrivers with voltage tester (Export models)

No. 4-341 for 110 - 380 V, No. 4-342 for 100 - 500 V

Blade: chrome vanadium, nickel-plated, fully insulated

Handle: transparent yellow plastic

4-341	40	3.0	0.6	72 x 14	14 g
4-342	95	4.0	0.8	85 x 18	33 g

VDE-voltage testers, 220 - 250 V, to VDE regulations 0426

Blade: chrome vanadium, nickel-plated, fully insulated

Handle: transparent plastic

4-343 VDE	60	3.0	0.7	76 x 15	15 g
4-344 VDE	100	3.5	0.7	92 x 18	31 g

Offset screwdrivers

Material: chrome vanadium, nickel-plated

No.	Total length mm	Blade width mm	Blade thickness mm	Blade-Ø mm	Weight
4-351	100	5.0	0.65	4.5	15 g
4-352	125	6.0	0.80	6.0	32 g



SCREWDRIVERS EUROLINE-POWER

The ergonomical formed hexagon handle consisting of hard and soft two-coloured components enables by a good power transmission a sparingly use of strength in operation.

Furthermore the slip off protection guarantees a sturdy and safety screwing.

Blade: chrom vanadium, hardened over its full length, matt chrome-plated, with black tip

Handle: impact-resistant, two-coloured plastic, with slip off protection and practical hanging up hole

Workshop-Screwdrivers



No.	Blade length mm	Blade width mm	Blade thickness mm	Handle size mm	Weight
4-502	75	3.0	0.5	94 x 26	36 g
4-503	100	4.0	0.8	94 x 26	42 g
4-504	100	5.0	1.0	105 x 30	64 g
4-506	125	6.0	1.2	117 x 33	98 g
4-508	150	7.0	1.2	117 x 33	120 g
4-509	175	8.0	1.2	128 x 36	166 g



Electrician's Screwdrivers



No.	Blade length mm	Blade width mm	Blade thickness mm	Handle size mm	Weight
4-522	75	3.0	0.5	94 x 26	36 g
4-523	100	4.0	0.8	94 x 26	40 g
4-524	150	5.0	1.0	105 x 30	72 g
4-525	200	5.0	1.0	105 x 30	80 g



Cross-recess screwdrivers



No.	Size	Blade length mm	Blade-Ø mm	Handle size mm	Weight
4-532	0	60	3.0	94 x 26	34 g
4-533	1	80	4.5	105 x 30	56 g
4-534	2	100	6.0	117 x 33	84 g
4-535	3	150	8.0	128 x 36	158 g



Cross-recess screwdrivers Pozidriv



No.	Size	Blade length mm	Blade-Ø mm	Handle size mm	Weight
4-542	0	60	3.0	94 x 26	34 g
4-543	1	80	4.5	105 x 30	56 g
4-544	2	100	6.0	117 x 33	84 g
4-545	3	150	8.0	128 x 36	158 g



TORX-Screwdrivers



No.	Size	Blade-length mm	for metric Thread	Handle size mm	Weight
6-981	T 6	50	M 2	94 x 26	36 g
6-982	T 7	50	M 2.5	94 x 26	36 g
6-983	T 8	60	M 2.5	94 x 26	38 g
6-984 L	T 9	60	M 3	94 x 26	38 g
6-985 L	T 10	80	M 3-3.5	94 x 26	40 g
6-986 L	T 15	80	M 3.5-4	105 x 30	54 g
6-987 L	T 20	100	M 4-5	105 x 30	56 g
6-988 L	T 25	100	M 4.5-5	105 x 30	60 g
6-989 L	T 27	115	M 4.5-5-6	105 x 30	68 g
6-991 L	T 30	115	M 6-7	117 x 33	96 g



from size T 9 with bore-hole in the tip



ESD/EGB ELECTRONICS SCREWDRIVERS



with slim, ergonomically formed handles from black **conductive** plastic. The centring head guarantees a precise working without exhaustion.

Blade: chrome vanadium, hardened over its full length, chrome-plated, with black tip

Handle: impact-resistant **conductive**, black plastic, electrostatic discharge according to DIN EN 100015/1

Screwdrivers

No.	Blade length mm	Blade width mm	Blade thickness mm	Blade Ø mm	Handle length mm	Weight
4-601	50	0.8	0.20	2.5	90	12 g
4-602	50	1.2	0.25	2.5	90	12 g
4-603	50	1.5	0.25	2.5	90	12 g
4-604	50	1.8	0.25	2.5	90	12 g
4-605	60	2.0	0.40	2.5	90	12 g
4-606	60	2.5	0.40	2.5	90	12 g
4-607	60	3.0	0.50	3,0	90	14 g

Cross-recess Screwdrivers

PH

No.	Size	Blade length mm	Blade Ø mm	Handle length mm	Weight
4-621	000	50	2.5	90	12 g
4-622	00	50	2.5	90	12 g
4-623	0	50	3.0	90	14 g

4-610 6-piece screwdriver set

in a practical table support from **conductive** material

Contents: 6 screwdrivers No. 4-601, 4-603, 4-604, 4-605, 4-606, 4-607

Weight: 141 g

4-620 6-piece screwdriver and cross-recess screwdriver set

in a practical table support from **conductive** material

Contents: 3 screwdrivers No. 4-602, 4-605, 4-607

3 cross-recess screwdrivers No. 4-621, 4-622, 4-623

Weight: 145 g

ESD/EGB SCREWDRIVERS

with special-square pattern handle from impact-resistant, **conductive** black plastic

Blade: chrome vanadium, hardened over its full length, chrome-plated, with black tip

Handle: impact-resistant, **conductive**, black plastic, electrostatic discharge according to DIN EN 100015/1

Screwdrivers

No.	Blade length mm	Blade width mm	Blade thickness mm	Handle size mm	Weight
4-632	100	4.0	0.8	92 x 21	46 g
4-633	125	5.5	1.0	100 x 23	75 g
4-643	300	5.5	1,2	100 x 23	108 g

Cross-recess screwdrivers

PH

No.	Size	Blade length mm	Blade Ø mm	Handle size mm	Weight
4-652	1	80	4.5	92 x 21	49 g
4-653	2	100	6.0	100 x 23	78 g

Cross-recess screwdrivers Pozidriv

PZ

No.	Size	Blade length mm	Blade Ø mm	Handle size mm	Weight
4-662	1	80	4.5	92 x 21	49 g
4-663	2	100	6.0	100 x 23	78 g



ELECTRONICS SCREWDRIVERS

with slim, ergonomically formed handles and swivel top

Blade: chrome vanadium, hardened over its full length, chrome-plated, with black tip

Handle: impact-resistant, grey plastic material, swivel top, amber-coloured

Screwdrivers

No.	Blade length mm	Blade width mm	Blade thickness mm	Blade Ø mm	Handle length mm	Weight
4-161	40	1.0	0.20	2.5	100	11 g
4-162	40	1.5	0.25	2.5	100	11 g
4-163	40	2.0	0.40	2.5	100	11 g
4-164	50	2.5	0.40	2.5	100	11 g
4-165	50	3.0	0.50	3.0	100	13 g
4-166	100	2.0	0.40	2.0	100	11 g
4-167	100	2.5	0.40	2.5	100	13 g
4-169	150	3.0	0.50	3.0	100	18 g

Cross-recess screwdrivers

PH 

No.	Size	Blade length mm	Blade Ø mm	Handle length mm	Weight
4-281	000	40	2.5	100	11 g
4-282	00	40	2.5	100	11 g
4-283	0	50	3.0	100	13 g
4-284	1	60	4.0	100	23 g
4-285	1	150	4.0	100	27 g

TORX-Screwdrivers



No.	Size mm	Blade length mm	for metric thread	Handle length mm	Weight
6-679	T 4	40	M 1.4-1.6	100	10 g
6-681	T 5	40	M 1.6-2	100	10 g
6-682	T 6	40	M 2	100	11 g
6-683	T 7	40	M 2.5	100	11 g
6-684	T 8	40	M 2.5	100	12 g
6-685 L	T 9	50	M 3	100	12 g
6-686 L	T 10	50	M 3-3.5	100	13 g

from Size T 9 with bore-hole in the tip



4-170 6-piece screwdriver and cross-recess screwdriver set

in a practical table support

Contents: 4 Screwdrivers No. 4-162, 4-163, 4-164 + 4-165
2 Cross-recess screwdrivers No. 4-282 + 4-283

Weight: 125 g

4-180 6-piece screwdriver and cross-recess screwdriver set

in a practical table support

Contents: 3 Screwdrivers No. 4-161, 4-162 + 4-163
3 Cross-recess screwdrivers No. 4-281, 4-282 + 4-283

Weight: 115 g

4-190 6-piece screwdriver and cross-recess screwdriver set

in a practical table support

Contents: 5 Screwdrivers No. 4-161, 4-162, 4-163,
4-164 + 4-165,

1 Cross-recess screwdriver No. 4-284

Weight: 135 g

6-680 6-piece TORX-Screwdriver set

in a practical table support

Contents: 6 TORX-Screwdrivers No. 6-681, 6-682, 6-683,
6-684, 6-685 + 6-686

Weight: 155 g



SCREWDRIVER SETS



4-910 9-piece interchangeable screwdriver set

double-ended screwdrivers in a useful folding plastic box for setting up or hanging up at the workshop place

Blades: chrome vanadium, hardened over their full lengths, matt-chrome plated, double ended, overall length 120 mm

Handle: for interchangeable blades with large absorption capacity, gripping collet and swivel top

Contents: handle as described above
screwdriver blade widths: 1.5 / 3.0 mm, 2.0 / 3.5 mm,
2.5 / 4.0 mm
cross-recess blades: size 000 / 00, size 0 / 1
TORX-screwdriver blades: T 6 / T 8, T 7 / T 9, T 10 / T 15

Weight: 150 g



4-950 11-piece interchangeable screwdriver set TRI WING / TORX

10 interchangeable blades and 1 handle packed in a sturdy canvas wallet with stick fastener

Blades: chrome vanadium, hardened over their full length, matt-polished, overall length 140 mm

Handle: for interchangeable blades with large absorption capacity, gripping collet and swivel top

Contents: handle as described above
TRI WING- blades: TW 1, TW 2, TW 3, TW 4
TORX-blades: T 10, T 15, T 20, T 25, T 27, T 30

Weight: 375 g



4-800 60-piece radio-screwdriver stand

Contents: 20 screwdrivers each No. 4-311, 4-315, 4-316, with chrome vanadium blades and transparent yellow plastic handles

Weight: 600 g

4-810 60-piece screwdriver stand

Contents: 20 screwdrivers each with tool steel blades, 40 x 3.0 mm, 60 x 3.0 mm and 80 x 3.0 mm and coloured plastic handles

Weight: 580 g

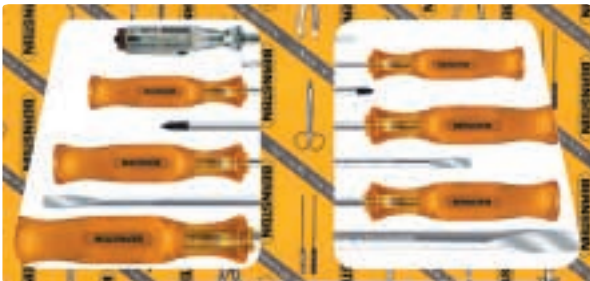

4-820 60-piece miniature screwdriver stand

Contents: 60 screwdrivers with tool steel blades, 40 x 1.8 mm and transparent yellow plastic handles

Weight: 235 g

4-850 7-piece screwdriver set

with special square pattern Bernstein handles visible packed in a carton box

Contents: 1 screwdriver each No. 4-102 S, 4-103 S, 4-104 S, 4-125 S, 4-271, 4-272 and 1 voltage tester No. 4-343 VDE

Weight: 470 g



4-530 6-piece screwdriver set

from series EUROline-Power, visible packed in a carton box

Contents: 1 workshop screwdriver each No. 4-504, 4-506
1 electrician's screwdriver each No. 4-523, 4-524
1 cross-recess screwdriver PH No. 4-533, 4-534

Weight: 540 g

WATCHMAKER'S SCREWDRIVERS

Cross-recess watchmaker's screwdrivers

Blade: chrome vanadium, burnished

Handle: metal, nickel-plated, with swivel top

No.	Size	Blade length mm	Total length mm	Weight
4-364	000	21	92	9 g
4-366	00	21	92	9 g
4-367	0	21	105	18 g
4-368	1	21	117	34 g

Watchmaker's screwdrivers

Blade: chrome vanadium, burnished

Handle: metal, nickel-plated, with swivel top

No.	Blade length mm	Blade width mm	Total length mm	Weight
4-371	14	1.0	85	7 g
4-372	18	1.5	90	7 g
4-373	21	2.0	105	18 g
4-374	24	2.5	108	18 g
4-375	24	3.0	120	37 g
4-376	27	3.5	123	38 g

4-360 3-piece watchmaker's screwdriver set

in a plastic wallet

Contents: 2 watchmaker's screwdrivers No. 4-372 + 4-374

1 cross-recess watchmaker's screwdriver No. 4-367

Weight: 68 g

4-365 3-piece watchmaker's screwdriver set

in a plastic wallet

Contents: 3 cross-recess screwdrivers No. 4-366, 4-367 + 4-368

Weight: 66 g

4-370 6-piece watchmaker's screwdriver set

in a metal case

Contents: 6 watchmaker's screwdrivers No. 4-371 - 4-376

Weight: 480 g

Watchmaker's screwdrivers

Blade: chrome vanadium, burnished

Handle: black plastic, with swivel top and colour coding

No.	Blade length mm	Blade width mm	Total length mm	Weight
4-381	18	1.0	104	5 g
4-382	18	1.5	104	6 g
4-383	18	2.0	104	6 g
4-384	18	2.5	104	6 g
4-385	18	3.0	104	6 g

4-380 5-piece watchmaker's screwdriver set

in a plastic box

Contents: 5 watchmaker's screwdrivers No. 4-381 - 4-385

Weight: 64 g

Watchmaker's storage screwdrivers with interchangeable blades

Blades: chrome vanadium, burnished

Handle: metal magazine, nickel-plated, with swivel top

4-391 Watchmaker's screwdriver magazine with 4 bits

1.5 – 2.0 – 2.5 – 3.0 mm blade width

Weight: 31 g

4-392 Watchmaker's screwdriver magazine with 4 bits

1.5 – 2.0 – 2.5 – 3.0 mm blade width

and 1 cross-recess blade size 0

Weight: 32 g

4-393 Watchmaker's screwdriver magazine with 3 bits

1.5 – 2.0 – 2.5 mm blade width and 2 cross-recess blades

Size 00 and 000

Weight: 32 g



RETAINING SCREWDRIVERS

TRIC screw holders

for inserting slotted screws into places difficult to reach

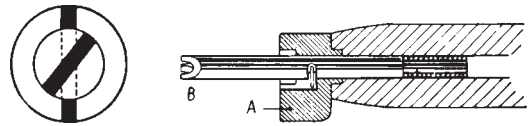

"TRIC" is especially easy to use. Push lever A as far as the stop with your thumb; insert blade B into the screw slot and release lever A. The screw is tight and can now be inserted into the hole. Release the holder by pressing lever A lightly in the same direction.

Special advantage:

Projecting controls do not hamper vision

Blade: special steel, plane-parallel, nickel-plated

Handle: impact-resistant, transparent yellow plastic

Do not use for tightening or undoing screws!

No.	Blade length mm	Blade width mm	Blade-Ø mm	Handle size mm	Weight
4-401	40	6.0	6.0	98 x 19	44 g
4-402	140	6.0	6.0	98 x 19	65 g
4-403	180	6.0	6.0	98 x 19	76 g
4-404	295	4.0	4.0	70 x 15	42 g
4-405	40	4.0	4.0	70 x 15	18 g
4-406	80	4.0	4.0	70 x 15	22 g
4-407	110	4.0	4.0	70 x 15	25 g
4-408	200	4.0	4.0	70 x 15	35 g
4-409	295	6.0	6.0	98 x 19	98 g

On request, all screw holders can be supplied with insulated blades.

Retaining screwdrivers

for inserting and tightening **slotted screws**

Blade: chrome vanadium, burnished, insulated

Handle: impact-resistant, transparent yellow plastic or black plastic for VDE-types

No.	Blade length mm	Blade width mm	Blade thickness mm	Handle size mm	Weight
4-431	100	3.0	0.5	90 x 18	35 g
4-432	125	4.0	0.6	100 x 22	65 g
4-433	150	5.0	0.8	105 x 24	93 g
4-441 VDE	100	3.0	0.5	90 x 18	34 g
4-442 VDE	125	4.0	0.6	100 x 22	58 g
4-443 VDE	150	5.0	0.8	105 x 24	88 g

Retaining screwdrivers

for inserting and tightening **cross-recess screws**

Blade: chrome vanadium, burnished, insulated

Handle: impact-resistant, transparent yellow plastic or black plastic for VDE-types

No.	Size	Blade length mm	Blade-Ø mm	Handle size mm	Weight
4-436	0	125	4.0	100 x 22	63 g
4-437	1	150	5.0	105 x 24	93 g
4-438	2	175	6.0	105 x 24	117 g
4-446 VDE	0	125	4.0	100 x 22	58 g
4-447 VDE	1	150	5.0	105 x 24	88 g
4-448 VDE	2	175	6.0	105 x 24	110 g

Screwdriver with guide sleeve

for easy, reliable adjustment of screw-type resistors and potentiometers with slotted shanks of 3.2 mm Ø

Blade: chrome vanadium, nickel-plated

Handle: impact-resistant, transparent yellow plastic

No.	Blade length mm	Blade width mm	Handle size mm	Weight
2-145	80	2.8	60 x 11	12 g

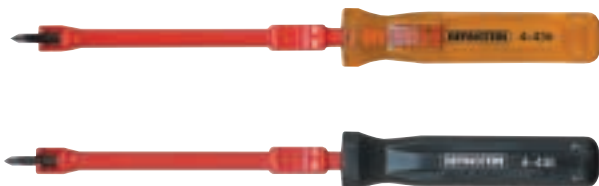
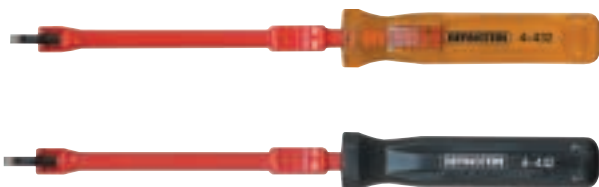

SAFETY TOOLS

BERNSTEIN VDE screwdrivers and VDE cross-recess screwdrivers are monitored by the VDE Test Centre.

Random samples are taken and type tests are performed in accordance with the regulations.

Permissible voltage at which the VDE screwdrivers can be used:
1000 V a.c. or 1500 V d.c.

The handle and blade insulation is moulded in one piece and is therefore permanently connected.



Safety insulated screwdrivers

to DIN 5265 VDE regulations EN 60.900

Blade: chrome vanadium, hardened over its full length, burnished

Handle: impact-resistant, red coated plastic

No.	Blade length mm	Blade width mm	Blade thickness mm	Handle size mm	Weight
14-601 VDE	75	2.5	0.4	80 x 18	18 g
14-602 VDE	100	3.5	0.5	80 x 18	24 g
14-603 VDE	100	4.0	0.6	80 x 18	27 g
14-604 VDE	125	5.5	0.8	100 x 24	64 g
14-606 VDE	150	6.5	1.0	100 x 24	83 g
14-608 VDE	175	8.0	1.2	110 x 26	133 g



Safety insulated cross-recess Phillips screwdrivers

to DIN 5262 VDE regulations EN 60.900

Blade: chrome vanadium, hardened over its full length, burnished

Handle: impact-resistant, red coated plastic

No.	Size	Blade length mm	Blade Ø mm	Handle size mm	Weight
14-631 VDE	0	60	3.0	80 x 18	20 g
14-632 VDE	1	80	4.5	90 x 21	35 g
14-633 VDE	2	100	6.0	100 x 24	62 g
14-634 VDE	3	150	8.0	110 x 26	125 g



Safety insulated Pozidriv cross-recess screwdrivers

to VDE regulations EN 60.900

Blade: chrome vanadium, hardened over its full length, burnished

Handle: impact-resistant, red coated plastic

No.	Size	Blade length mm	Blade Ø mm	Handle size mm	Weight
14-641 VDE	0	60	3.0	80 x 18	20 g
14-642 VDE	1	80	4.5	90 x 21	34 g
14-643 VDE	2	100	6.0	100 x 24	62 g
14-644 VDE	3	150	8.0	110 x 26	115 g



14-600 VDE 7-piece VDE screwdriver set

visibly packed in a carton box

- Contents:
- 14-601 VDE 2.5 x 0.4 mm screwdriver
 - 14-602 VDE 3.5 x 0.5 mm screwdriver
 - 14-604 VDE 5.5 x 0.8 mm screwdriver
 - 14-606 VDE 6.5 x 1.0 mm screwdriver
 - 14-631 VDE cross-recess screwdriver, size 0
 - 14-632 VDE cross-recess screwdriver, size 1
 - 4-343 VDE voltage tester, 150 V - 250 V

Weight: 350 g

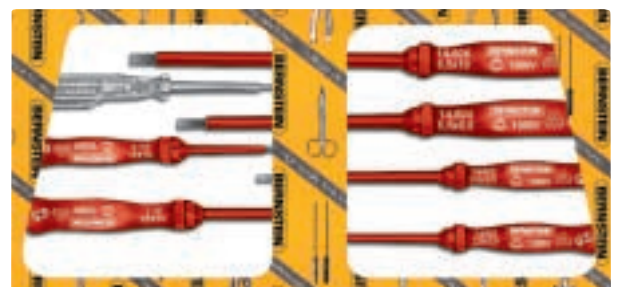



BERNSTEIN

Electronic-Tools

Quality for the specialist

ELECTRONIC-TWEEZERS

No.	Length		Finish	Weight
	mm	inches		

Component tweezers

made from steel, with insulated jaws, a special tool for easy insertion and removal of plug-in transistors of various sizes

5-006	140	5 1/2"	nickel-plated	25 g
5-006-7	140	5 1/2"	stainless-non-reflective	25 g

Component tweezers

made from steel, with semi-circular jaws, 5 mm wide, to facilitate the insertion and removal of horizontally positioned components of various sizes

5-007	140	5 1/2"	nickel-plated	25 g
5-007-7	140	5 1/2"	stainless-non-reflective	25 g

Component tweezers

made from steel, with jaws bent inwards at right angles, 5 mm wide, to facilitate the removal of round or cube-shaped components

5-008	140	5 1/2"	nickel-plated	25 g
5-008-7	140	5 1/2"	stainless-non-reflective	25 g

Component tweezers

made from steel, with insulated jaws, 5.5 mm wide, for gripping flat components

5-009	140	5 1/2"	nickel-plated	25 g
5-009-7	140	5 1/2"	stainless-non-reflective	25 g

No.	Length		Gripping cavity width		Finish	Weight
	mm	inches	width	Ø mm		

Miniature component tweezers

made from anti-magnetic steel, stainless and acid-resistant to facilitate the insertion and removal of components

Gripping cavity straight

5-011	120	4 3/4"	3.0	0.75	polished	13 g
5-012	120	4 3/4"	3.5	1.50	polished	13 g
5-013	120	4 3/4"	3.5	3.50	polished	14 g
5-014	120	4 3/4"	5.0	6.50	polished	14 g

Gripping cavity diagonal

5-015	120	4 3/4"	4.0	3.50	polished	14 g
-------	-----	--------	-----	------	----------	------

No.	Length		Finish	Weight
	mm	inches		

Contact tweezers

made from anti-magnetic steel, stainless and acid-resistant, with bent, flat jaws

5-018	110	4 3/8"	polished	11 g
-------	-----	--------	----------	------

IC-tweezers

for gripping, insertion and removal of IC's

2-601	125	5"	nickel-plated	20 g
-------	-----	----	---------------	------



SPECIAL-TWEEZERS

No.	Length		Finish	Weight
	mm	inches		

Engineer's tweezers

made from steel, with fine, bent tips, finely serrated

5-107	150	6"	nickel-plated	22 g
5-107-1	150	6"	polished, with antiallergical coating	23 g
5-107-6	150	6"	nickel-plated, strong PVC-insulated	27 g
5-107-7	150	6"	stainless, matt-non-reflective	25 g

Heat dissipating tweezers

made from steel, for use when soldering transistors, gold-bonded diodes etc., the flat, wide points of the tweezers are narrow and provided with copper jaws

5-115	165	6 1/2"	nickel-plated	35 g
-------	-----	--------	---------------	------

Engineer's tweezers

made from steel, heavy type, straight, flat and wide, tips with serration

5-116	120	4 3/4"	nickel-plated	17 g
5-117	145	5 3/4"	nickel-plated	25 g
5-117-1	145	5 3/4"	polished, with antiallergical coating	26 g
5-117-6	145	5 3/4"	nickel-plated, strong PVC insulated	31 g
5-117-7	145	5 3/4"	stainless, matt-non-reflective	26 g

Jewellerie's tweezers

made from steel, fine-rounded tips, with X-serration

5-119	140	5 1/2"	nickel-plated	21 g
5-120	160	6 1/4"	nickel-plated	25 g

Engineer's tweezers

made from steel, straight, with narrow pointed tips, finely serrated

5-121	120	4 3/4"	nickel-plated	14 g
5-121-1	120	4 3/4"	polished, with antiallergical coating	14 g
5-121-6	120	4 3/4"	nickel-plated, strong PVC-insulated	17 g
5-121-7	120	4 3/4"	stainless, matt-non-reflective	13 g
5-122	155	6 1/8"	nickel-plated	20 g

Sheet-metal tweezers

straight, flat and pointed

5-125	110	4 3/8"	nickel-plated	12 g
5-125-1	110	4 3/8"	polished, with antiallergical coating	13 g

Sheet-metal tweezers

with sliding fastener for a firm grip, straight, with narrow pointed tips

5-126	160	6 1/4"	nickel-plated	22 g
-------	-----	--------	---------------	------



SPECIAL ELECTRONIC-TWEEZERS

No.	Length mm inches	Gripping cavity width Ø mm	Finish	Weight
-----	---------------------	-------------------------------	--------	--------

Miniature component tweezers

teflon-coated (green), made from steel, to facilitate insertion and removal of components, with straight gripping cavity

5-021-9	120 4 3/4"	3.0 0.75	teflon-coated	11 g
---------	------------	----------	---------------	------

No.	Length mm inches	Finish	Weight
-----	---------------------	--------	--------

Watchmaker's tweezers

teflon-coated (green), made from steel, very sharply pointed, straight

5-027-9	110 4 3/8"	teflon-coated	13 g
---------	------------	---------------	------

Engineer's tweezers

teflon-coated (green), made from steel, with fine bent tips, finely serrated

5-107-9	150 6"	teflon-coated	22 g
---------	--------	---------------	------

Engineer's tweezers

teflon-coated (green), made from steel, heavy type, straight, flat and wide, with serration

5-117-9	145 5 3/4"	teflon-coated	25 g
---------	------------	---------------	------

Jewellerie's tweezers

teflon-coated (green), made from steel, fine-rounded tips, finely serrated

5-119-9	140 5 1/2"	teflon-coated	19 g
---------	------------	---------------	------

Engineer's tweezers

teflon-coated (green), made from steel, straight, with narrow pointed tips, finely serrated

5-121-9	120 4 3/4"	teflon-coated	13 g
---------	------------	---------------	------

SPECIAL-TWEEZERS FROM CERAMIC

Ceramic tweezers meet highest standards due to their excellent mechanical, thermic and electrical features. Ceramic tweezers are harder than conventional tweezers, therefore the tips have a longer durability. They are non magnetic, antistatic, acid-resistant and alkaliproof, solder-repellent and heat-resistant.

No.	mm	Length inches	Finish	Weight
-----	----	------------------	--------	--------

Ceramic tweezers

5-081	130	5 1/8"	straight, pointed	15 g
5-082	130	5 1/8"	straight, microscopic-pointed	16 g

Ceramic-tipped tweezers

5-095	130	5 1/8"	especially slim and pointed	6 g
5-096	130	5 1/8"	slim - 2 mm flat tips	6 g



SPECIAL TWEEZERS

No.	Length		Finish	Weight
	mm	inches		

Watchmaker's tweezers

made from stainless **or** anti-magnetic steel, straight, very sharply pointed

5-131	110	4 3/8"	polished-stainless, sharply pointed	11 g
5-132	110	4 3/8"	polished-anti-magnetic, stainless and acid-resistant, sharply pointed	13 g

Watchmaker's tweezers

made from stainless **or** anti-magnetic steel, bent, very sharply pointed

5-134	115	4 1/2"	polished-stainless	12 g
5-135	115	4 1/2"	polished-anti-magnetic, stainless and acid-resistant	12 g

Engineer's tweezers

made from steel, straight, with flat, 2 mm wide tips

5-136	120	4 3/4"	polished-nickel-plated	17 g
-------	-----	--------	------------------------	------

Anti-magnetic tweezers

straight, with flat, pointed tips

5-145	130	5 1/8"	polished-anti-magnetic stainless and acid-resistant	18 g
-------	-----	--------	--	------

Crossed tweezers (self-locking tweezers)

made from steel, jaws 5 mm wide, finely serrated

5-155	160	6 1/4"	polished-nickel-plated	35 g
5-155-1	160	6 1/4"	polished, with antiallergical coating	36 g

Crossed soldering tweezers (self-locking tweezers)

made from steel, with bent tips and gripping well hand guard

5-156	160	6 1/4"	polished-nickel-plated	29 g
-------	-----	--------	------------------------	------

TITAN TWEEZERS

Tweezers made from Titan are for highest demands, have a light weight, immunity to corrosion, even to aggressive acids, they are antimagnetic, antibacterial, especially conductive, solder-repellent and non-reflective. The melting point is 1677°C.

No.	Length		Finish	Weight
	mm	inches		

5-031	110	4 3/8"	matt-stainless, sharply pointed	9 g
5-035	120	4 3/4"	matt-stainless, sharply pointed	9 g
5-036	145	5 3/4"	matt-stainless, straight – round – wide, tips with fine serration	15 g
5-037	150	6"	matt-stainless, fine bent tips, tips with fine serration	15 g



SPECIAL-TWEEZERS FOR THE SMD-TECHNIQUE

stainless – matt finish – non-reflective – anti-magnetic – acid-resisting

No.	Length		Finish	Weight
	mm	inches		
5-051	115	4 1/2"	straight, pointed	15 g
5-052	110	4 3/8"	bent, very sharply pointed	13 g
5-053	110	4 3/8"	obliquely angled, very sharply pointed	13 g
5-054	120	4 3/4"	sickle-shaped curved, very sharply pointed	16 g
5-057	120	4 3/4"	self-locking, straight, pointed	13 g
5-058	120	4 3/4"	self-locking, bent, pointed	13 g
5-061	115	4 1/2"	bent, 2 mm wide, flat tips	16 g
5-062	115	4 1/2"	bent, flat tips, with gripping cavity	16 g
5-071	85	3 3/8"	straight, pointed	8 g
5-075	135	5 3/8"	straight, very sharply pointed, grip surface offset	13 g

ESD/EGB TWEEZERS

made from antistatic, black plastic material, reinforced with glassfibre conductive and acid-resistant

No.	Length		Finish	Weight
	mm	inches		
5-191	120	4 3/4"	straight, rounded tips	5 g
5-192	120	4 3/4"	straight, 3 mm flat-hand tips, grip surface offset	4 g
5-193	120	4 3/4"	straight, 6 mm flat, and wide tips	5 g
5-194	120	4 3/4"	bent, pointed tips	5 g
5-195	120	4 3/4"	straight, pointed tips, grip surface offset	4 g

5-190 6-piece set of ESD/EGB tweezers

in a practical table support from **conductive** material

Contents: 5 tweezers made from conductive black plastic material, reinforced with glass fibre No. 5-191, 5-192, 5-193, 5-194, 5-195

1 tweezers with ceramic tips No. 5-095

Weight: 120 g

5-090 5-piece set of ESD/EGB tweezers

in a practical table support from **conductive** material

Contents: 5 tweezers made from conductive black plastic material, reinforced with glass fibre No. 5-191, 5-192, 5-193, 5-194, 5-195

Weight: 94 g



SETS OF SPECIAL TWEEZERS

in wallets of recycable nylon

5-030 3-piece set of electronic tweezers from titan

matt-stainless - super-light - immunity to corrosion - acid-resistant - solder-repellent - antibacterial - especially conductive - non-reflective

Weight: 60 g

No.	Description of individual tools
-----	---------------------------------

- | | |
|-------|---|
| 5-031 | Titan-tweezers , sharply pointed, 110 mm |
| 5-036 | Titan-tweezers , straight, round, wide, 145 mm, with serration |
| 5-037 | Titan-tweezers , fine bent tips, 150 mm |



5-050 6-piece set of special tweezers for the SMD-technique

stainless - matt finish - non-reflective - anti-magnetic - acid-resisting

Weight: 120 g

No.	Description of individual tools
-----	---------------------------------

- | | |
|-------|--|
| 5-051 | SMD-tweezers , straight pointed, 115 mm |
| 5-052 | SMD-tweezers , bent, very sharply pointed, 110 mm |
| 5-054 | SMD-tweezers , sickle-shaped curved, very sharply pointed, 120 mm |
| 5-058 | SMD-tweezers , crossed, bent, pointed, 120 mm |
| 5-061 | SMD-tweezers , bent, flat tips 2 mm wide, 115 mm |
| 5-062 | SMD-tweezers , bent, flat tips, with gripping cavity, 115 mm |



5-100 12-piece set special tweezers and tools

Weight: 360 g

No.	Description of individual tools
-----	---------------------------------

- | | |
|---------|---|
| 2-126 | Desoldering lever , slotted at one end, with plastic handle, 115 mm |
| 2-127 | Tin knife with plastic handle, 115 mm |
| 2-601 | IC-tweezers , nickel-plated, 125 mm, for gripping, inserting and removing IC,s |
| 5-006 | Component tweezers , nickel-plated, with insulated jaws, a special tool for easy insertion and removal of plug-in transistors of various sizes |
| 5-107 | Engineer's tweezers , made from steel, with bent tips, 150 mm, nickel-plated |
| 5-107-6 | Engineer's tweezers , as above, strong PVC-insulation |
| 5-115 | Heat dissipating tweezers , 165 mm, nickel-plated, for soldering transistors, gold-bonded diodes etc. |
| 5-117 | Engineer's tweezers , straight, flat, wide, 145 mm, nickel-plated |
| 5-117-6 | Engineer's tweezers , as above, strong PVC-insulation |
| 5-121 | Engineer's tweezers , straight, with narrow pointed tips, 120 mm, nickel-plated |
| 5-145 | Anti-magnetic tweezers , straight, with flat, pointed tips, 130 mm, polished, stainless and acid-resistant |
| 5-156 | Crossed soldering tweezers , (self-locking tweezers), made from steel, with bent tips and gripping well hand-guard, nickel-plated, 160 mm |



FILES - SCISSORS

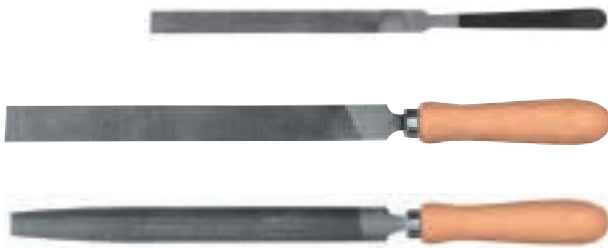
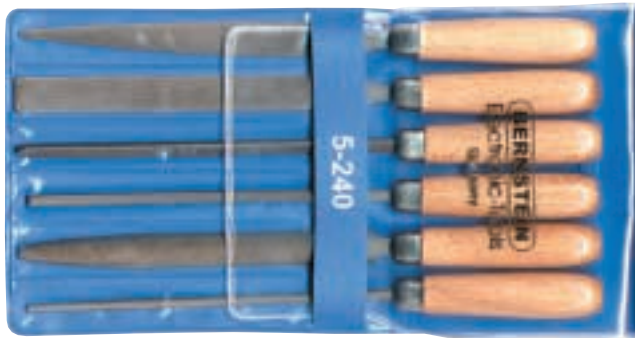
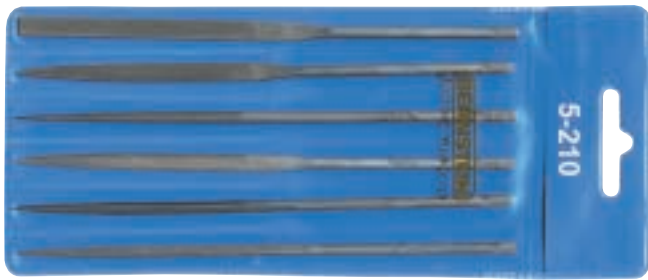

No.	Length		Finish	Weight
	mm	inches		

Needle files without handle

5-201	140	5 1/2"	flat-hand	7 g
5-202	140	5 1/2"	flat-entering	6 g
5-203	140	5 1/2"	round	6 g
5-204	140	5 1/2"	half round	6 g
5-205	140	5 1/2"	three square	6 g
5-206	140	5 1/2"	square	6 g

5-210 6-piece set of needle files

No. 5-201 – 5-206 in plastic wallet 47 g

Warding files with wooden handle

overall length 175 mm – 6 3/4"

5-231	100	4"	flat-hand	17 g
5-232	100	4"	flat-entering	14 g
5-233	100	4"	round	13 g
5-234	100	4"	half round	27 g
5-235	100	4"	three square	18 g
5-236	100	4"	square	15 g

5-240 6-piece set of warding files

No. 5-231 – 5-236 with wooden handle, in plastic wallet 113 g

Contact file

with fine cut

5-261	150	6"	flat-hand	9 g
-------	-----	----	-----------	-----

Engineer's files with wooden handle

heavy type, fine cut, overall length 320 mm – 13 1/4"

5-271	200	8"	flat-hand	148 g
5-274	200	8"	half round	153 g

Clamping scissors

made from stainless steel, with serrated gripping jaws

5-161	130	5 1/8"	polished	20 g
-------	-----	--------	----------	------

Special-scissors for cutting sheet-metal and wires, jaws extremely slim, serrated, for precision work

5-301	110	4 3/8"	nickel-plated	27 g
-------	-----	--------	---------------	------

Universal cutting shears

for wires and thin sheet materials

5-306	180	7"	black-lacquered polished head	85 g
-------	-----	----	----------------------------------	------

Telephone and cable shears

with one serrated blade

5-308	125	5"	nickel-plated	63 g
-------	-----	----	---------------	------

Domestic scissors

5-311	180	7"	nickel-plated, polished	85 g
-------	-----	----	-------------------------	------

SHEARS - SCISSORS - STRIPPING TOOLS

No.	Length		Finish	Weight
	mm	inches		

Ribbon cable cutter

made from steel, with handy plastic handles, for special cutting of ribbon cable, also suitable for cutting of ledges and profiles from plastic, with interchangeable one-way blade and plastic support with straight stop

5-307	220	8 3/4"	chrome-plated cutting length 55 mm	300 g
5-307-1			spare blade	3 g

Cable stripping shears

made from stainless steel, with handy plastic handles, compression spring, self-locking. The sheathing of round, flat and shield cables may be removed easily

5-309	190	7 1/2"	polished	125 g
-------	-----	--------	----------	-------

Combination cutters (general purpose cutters)

made from stainless steel, with serrated cutting edge, handy plastic handles and compression spring

5-304	190	7 1/2"	polished	110 g
5-305	140	5 1/2"	polished	52 g

Wire scraper tweezers

for stripping varnish or any other material on wires 0.6 mm Ø made from steel, with interchangeable cutters

5-181	130	5 1/8"	burnished	28 g
5-182			cutters (2 pieces)	2 g

Electrician's knife

with steel blade, wire scraper and wooden handle

5-501	200	8"	knife opened	81 g
	110	4 3/8"	knife closed	

Pocket knife

with one blade

5-511	180	7"	knife opened	44 g
	100	4"	knife closed	

Universal blade knife

made from plastic material with adjustable blade

5-515	140	5 1/2"		10 g
5-516			set of blades for 5-515 (10 pieces)	25 g
5-517	150	6"	heavy type	32 g
5-518			set of blades for 5-517 (10 pieces)	59 g

Rotary coaxial cable stripper

Handy plastic tool with adjustable cutters, for cable types RG 58, RG 59 and RG 62

5-0601	100	4"	black	51 g
--------	-----	----	-------	------

Universal stripping tool

Handy plastic tool with adjustable cutters, very easy to use
Weight: 47 g

5-0605	100	4"		
--------	-----	----	--	--

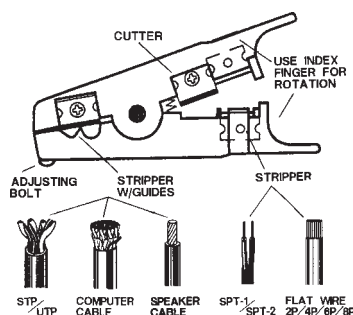

5-515



5-0601



5-0605

STRIPPING TOOLS

No.	Length mm	inches	Finish	Weight
-----	--------------	--------	--------	--------



Stripping and crimping tool

for easy stripping, crimping and cutting only with one tool, the special scanning system adjusts automatically to the wire diameter

5-532	160	6 1/4"	Working range: easy stripping from 0.5 to 6.0 mm ² stripping length 5 mm crimping ranges for terminals: 0.5 to 2.5 and 4.0 to 6.0 mm ² cutting capacity of the side cutters max. 6.0 mm ² , solid conductors max. 4.0 mm ²	120 g
-------	-----	--------	---	-------



Coax cable stripper

for two-or-three-level stripping of all common coaxial cables (e.g. antenna- and transmission cables) and flexible cables

5-535	110	4 3/8"	Working range: coax cable from 4.8 to 7.5 mm outside-Ø for flexible cable 3 x 0.75 mm ² , 10 mm ² and 16 mm ²	30 g
-------	-----	--------	---	------



Round cable stripper

with ergonomical handles

5-536	125	5"	Working range: round and continental type cable from 8 to 13 mm Ø e.g. NYM 3 x 1.5 mm ² up to 5 x 2.5 mm ²	45 g
-------	-----	----	---	------



Swivel-blade cable strippers

for accurate, fast and safe stripping of all common round cables of 4 - 28 mm Ø, cutting depth and adjustment via adjusting screw at end of handle, moving inner blade automatically adjusts itself from circular to longitudinal cuts

5-503	130	5 1/8"	Working range: without blade: 8 - 28 mm Ø	70 g
5-504	130	5 1/8"	without blade: 4 - 16 mm Ø	70 g
5-505	170	6 3/4"	hook blade: 8 - 28 mm Ø	80 g
5-506	180	7"	straight blade: 8 - 28 mm Ø	80 g



Automatic wire stripper Super

fully insulated automatic wire stripper for all common stranded and solid conductors of 0.2 - 6.0 mm², adjustable length stop of 5 - 12 mm, removable if required, built-in side cutters for max. 2 mm Ø

5-531	200	8"	plastic	130 g
-------	-----	----	---------	-------



BERNSTEIN

Electronic-Tools

Quality for the specialist



ESD/EGB SPECIAL-TOOLS



with slim, ergonomically formed handles from black, **conductive** plastic. The centring head guarantees a precise working without exhaustion.

Blade: chrome vanadium, hardened over its full length, chrome-plated, black tip,

Handle: impact-resistant, **conductive** black plastic, electrostatic discharge according to DIN EN 1000 15/1

TORX-screwdrivers



No.	Size	Blade length mm	for metric thread	Handle length mm	Weight
6-659	T 4	50	M 1.4-1.6	90	12 g
6-661	T 5	50	M 1.6-2	90	12 g
6-662	T 6	50	M 2	90	16 g
6-663	T 7	50	M 2.5	90	13 g
6-664	T 8	60	M 2.5	90	14 g
6-665 L	T 9	60	M 3	90	19 g
6-666 L	T 10	60	M 3-3.5	90	20 g

from size T 9 with bore-hole in the tip



6-660 6-piece TORX-screwdriver-set,

in a practical support from **conductive** material

Contents: 6 TORX-screwdrivers No. 6-661, 6-662, 6-663, 6-664, 6-665, 6-666

Weight: 163 g

Wrench keys



No.	A/F mm	Blade length mm	Handle length mm	Weight
6-631	0.7	50	90	11 g
6-632	0.9	50	90	12 g
6-633	1.3	50	90	12 g
6-634	1.5	50	90	12 g
6-635	2.0	60	90	12 g
6-636	2.5	60	90	14 g

6-630 6-piece wrench key set

in a practical support from **conductive** material

Contents: 6 wrench keys No. 6-631, 6-632, 6-633, 6-634, 6-635, 6-636

Weight: 142 g

Socket wrenches



No.	A/F mm	Blade length mm	Handle length mm	Weight
6-611	1.5	70	90	14 g
6-612	2.0	70	90	14 g
6-613	2.5	70	90	14 g
6-614	3.0	70	90	14 g
6-615	3.2	70	90	14 g
6-616	3.5	70	90	15 g
6-617	4.0	70	90	15 g
6-618	4.5	70	90	16 g
6-619	5.0	70	90	16 g
6-621	5.5	70	90	20 g

6-610 6-piece socket wrenches

in a practical support from **conductive** material

Contents: 6 Socket wrenches No. 6-612, 6-614, 6-617, 6-618, 6-619, 6-621

Weight: 156 g



SOCKET WRENCHES

Socket wrenches, long, with handle



Blade: chrome vanadium, hardened over its full length, chrome-plated
Handle: special square pattern Bernstein handle, impact-resistant, transparent yellow plastic

No.	A/F mm	Blade length mm	Handle size mm	Weight
6-101	3.5	140	92 x 21	70 g
6-102	4.0	140	92 x 21	72 g
6-103	4.5	140	92 x 21	72 g
6-104	5.0	140	92 x 21	75 g
6-105	5.5	140	92 x 21	77 g
6-106	6.0	140	92 x 21	77 g
6-107	7.0	140	92 x 21	92 g
6-108	8.0	140	92 x 21	94 g

6-100 8-piece socket wrench set in a plastic wallet

Contents: 8 socket wrenches No. 6-101 – 6-108
 Weight: 650 g

Socket wrenches, short, with handle



Blade: chrome vanadium, hardened over its full length, nickel-plated
Handle: impact-resistant, transparent yellow plastic

No.	A/F mm	Blade length mm	Handle size mm	Weight
6-151	3.5	100	98 x 21	57 g
6-152	4.0	100	98 x 21	60 g
6-153	4.5	100	98 x 21	60 g
6-154	5.0	100	98 x 21	65 g
6-155	5.5	100	98 x 21	65 g
6-156	6.0	100	98 x 21	65 g
6-157	7.0	100	98 x 21	70 g
6-158	8.0	100	98 x 21	70 g
6-159	9.0	140	103 x 24	106 g
6-161	10.0	140	103 x 24	110 g
6-162	11.0	140	103 x 24	130 g
6-163	12.0	140	103 x 24	135 g
6-164	13.0	140	103 x 24	135 g
6-165	14.0	140	103 x 24	144 g

6-150 8-piece socket wrench set in a plastic wallet

Contents: 8 socket wrenches No. 6-151 – 6-158
 Weight: 530 g

Socket wrenches without handles with tangs for interchangeability



Material: chrome vanadium, nickel-plated

No.	A/F mm	Wrench length mm	Inches for No. 6-190	Weight
6-201	4.0	140	1/8"	30 g
6-202	5.5	140	5/32"	35 g
6-203	6.0	140	3/16"	35 g
6-204	7.0	140	7/32"	40 g
6-205	8.0	140	1/4"	40 g
6-206	9.0	140	5/16"	43 g
6-207	10.0	140	3/8"	45 g

6-200 8-piece socket wrench in a plastic wallet

Contents: 7 socket wrenches No. 6-201 – 6-207
 1 plastic spring handle. 4-775
 Weight: 310 g

6-190 8-piece socket wrench set same as 6-200, but in imperial dimensions

6-210 6-piece socket wrench set in a plastic wallet

Contents: 5 socket wrenches No. 6-201 – 6-205
 1 plastic spring handle No. 4-775
 Weight: 225 g

6-360 17-piece combination socket wrench set in clear pack

Contents: 1 flexible holder No. 6-461 with special square pattern Bernstein handle
 1 adapter for bits No. 6-406
 7 sockets No. 6-301 - 6-307
 8 bits No. 6-411 - 6-412 - 6-413 - 6-421 - 6-422 - 6-431 - 6-432 - 6-433
 Weight: 340 g



6-108



6-205



6-360

SOCKET WRENCH DRIVES AND CONNECTORS

Sets of socket wrenches in metal cases

Typ: 1/4" square drive, chrome vanadium, chrome-plated

- 6-300 **12-piece socket wrench set in metal case**
 Contents: 11 sockets No. 6-301 – 6-312, 1 holder No. 6-331
 Weight: 630 g
- 6-310 **15-piece socket wrench set in metal case**
 Contents: 11 sockets No. 6-301 – 6-312, 1 holder No. 6-331
 1 sliding tee bar No. 6-332, 1 universal joint No. 6-333,
 1 rigid extension No. 6-337
 Weight: 744 g
- 6-320 **16-piece socket wrench set in metal case**
 Contents: 11 sockets No. 6-301 – 6-312, 1 holder No. 6-331
 1 sliding tee bar No. 6-332, 1 universal joint No. 6-333,
 1 reversible ratchet No. 6-334, 1 rigid extension No. 6-337
 Weight: 815 g
- 6-330 **16-piece socket wrench set in metal case**
 Contents: 11 sockets No. 6-301 – 6-312, 1 holder No. 6-331
 1 sliding tee bar No. 6-332, 1 universal joint No. 6-333,
 1 reversible ratchet No. 6-335, 1 rigid extension No. 6-337
 Weight: 830 g

Accessories

Typ: 1/4" square drive, chrome vanadium, chrome-plated

- 6-331 **Socket wrench holder** with special square pattern Bernstein handle Weight 65 g
- 6-332 **Sliding tee bar** 45 g
- 6-333 **Universal joint** 25 g
- 6-334 **Reversible ratchet, 150 mm long** 80 g
- 6-335 **Reversible ratchet, 150 mm long** 100 g
- 6-337 **Rigid extension, 100 mm long** 45 g

Sockets

Typ: 1/4" square drive, chrome vanadium, chrome-plated

No.	A/F mm	Total length mm	Weight	No.	A/F mm	Total length mm	Weight
6-301	4.0	25	10 g	6-307	8.0	25	13 g
6-302	4.5	25	10 g	6-308	9.0	25	16 g
6-303	5.0	25	10 g	6-309	10.0	25	19 g
6-304	5.5	25	10 g	6-311	11.0	25	27 g
6-305	6.0	25	10 g	6-312	13.0	25	31 g
6-306	7.0	25	11 g				

- on special request also in imperial dimensions available -

Bit holder with square drive and hexagonal location for bits

Material: chrome vanadium, chrome-plated

No.	Drive	Location	Total length mm	Weight
6-406	1/4"	1/4"	25	15 g

Screwdriver bits, 1/4" hexagon drive

Material: special steel, steel grey

No.	Blade width mm	Blade thickness mm	Total length mm	Weight
6-411	4.0	0.5	25	5 g
6-412	4.5	0.6	25	5 g
6-413	5.5	0.8	25	5 g
6-414	6.5	1.2	25	5 g
6-415	8.0	1.6	25	6 g

Cross-recess screwdriver bits

1/4" hexagon drive

Material: special steel, steel grey

No.	Size	Typ	Total length mm	Weight
6-421	1	PH	25	5 g
6-422	2	PH	25	5 g
6-423	3	PH	25	5 g
6-425	1	PZ	25	5 g
6-426	2	PZ	25	5 g
6-427	3	PZ	25	5 g
6-431	3.0 mm	hexagon for M4	25	5 g
6-432	4.0 mm	hexagon for M5	25	5 g
6-433	5.0 mm	hexagon for M6	25	5 g

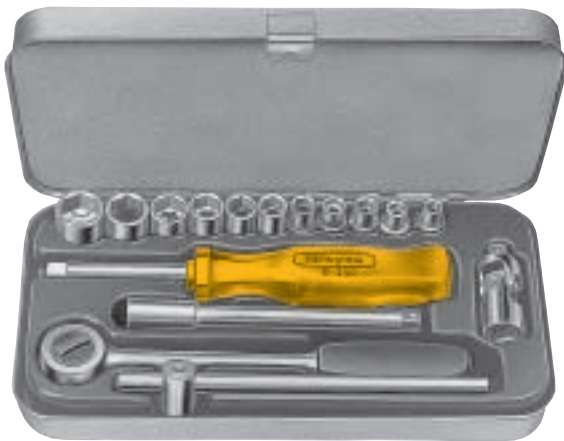

6-331

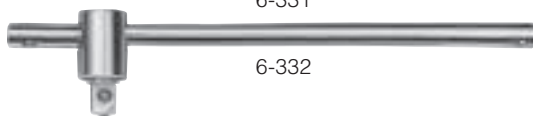

6-332



6-333



6-337



6-312



6-406



6-411



6-421



6-425



6-431

SCREWDRIVER BITS

Screwdriver bits

1/4" hexagon drive

Material: chrome vanadium, steel grey, DIN

6-410 7-piece Bit-Box

Handy plastic box with hexagon hole in the bottom for makeshift screwing

Contents: 1 bit each

- No. 6-413 \ominus 5.5 x 0.8 mm
- No. 6-415 \ominus 8.0 x 1.6 mm
- No. 6-421 \oplus Phillips size 1
- No. 6-422 \oplus Phillips size 2
- No. 6-425 \oplus Pozidriv size 1
- No. 6-426 \oplus Pozidriv size 2

1 universal bit holder
Weight: 70 g

6-440 7-piece Torx-Bit-Box

Handy plastic box with hexagon hole in the bottom for makeshift screwing

Contents: 6 Torx bits of the following sizes:
T 10, T 15, T 20, T 25, T 30, T 40,

1 universal bit holder
Weight: 70 g



WRENCHES

Sets of wrenches

Material: chrome vanadium, chrome-plated

6-500 5-piece double open-ended wrench set

Contents: 5 double open-ended wrenches 6 x 7 – 8 x 9 – 10 x 11 – 12 x 13 and 14 x 17 mm

Weight: 270 g

6-550 5-piece ring wrench set

double-offset

Contents: 5 ring wrenches 6 x 7 – 8 x 9 – 10 x 11 – 12 x 13 and 14 x 17 mm

Weight: 620 g

6-600 7-piece combination wrench set

Contents: 7 combination wrenches 6 – 7 – 8 – 9 – 10 – 11 and 13 mm

Weight: 230 g

6-650 5-piece ring wrench set

Contents: 5 ring wrenches 6 x 7 – 8 x 9 – 10 x 11 – 12 x 13 and 14 x 15 mm

Weight: 160 g

6-750 6-piece special double open-ended wrench set in plastic case

Material: chrome vanadium, bright nickel-plated, extra slim

Contents: 4 double open-ended wrenches 3.0 x 3.5 – 4.0 x 4.5 – 5.0 x 5.5 and 6.0 x 6.5 mm material thickness 1.5 mm, 120 mm long
2 double open-ended wrenches 7 x 8 and 9 x 10 mm material thickness 2 mm, 125 mm long

Weight: 90 g



Adjustable wrenches

Material: chrome vanadium, chrome-plated

No.	Jaw opening mm	Total length mm	Jaw length mm	Weight
6-771	0 – 12	100	12	55 g
6-772	0 – 18	150	22	145 g
6-773	0 – 23	200	25	230 g

Fitting wrench with protection jaws, for chrome-plated fittings

Material: chrome vanadium, burnished

No.	Jaw opening mm	Total length mm	Jaw length mm	Weight
6-781	55	270	47	720 g



SPECIAL WRENCHES

Wrench keys

angle-shaped screwdrivers for hex socket-head screws

Material: special steel, nickel-plated

No.	A/F mm	No.	Inches	A/F ≈ mm	Leg length mm		Weight
					A	B	
6-811	0.89	-	-	-	30 x 10	1 g	
6-812	1.0	6-851	3/64	1.19	46 x 10	1 g	
6-813	1.5	6-852	1/16	1.59	50 x 12	1 g	
6-814	2.0	6-853	5/64	1.98	55 x 15	2 g	
6-815	2.5	6-854	3/32	2.38	60 x 18	3 g	
6-816	3.0	6-855	1/8	3.18	65 x 20	5 g	
6-817	3.5	6-856	9/64	3.56	68 x 22	8 g	
6-818	4.0	6-857	5/32	3.97	72 x 25	11 g	
6-819	4.5	6-858	3/16	4.76	75 x 27	13 g	
6-821	5.0	-	-	-	80 x 28	19 g	
6-822	5.5	6-859	7/32	5.56	85 x 30	22 g	
6-823	6.0	6-861	1/4	6.35	90 x 32	28 g	
6-825	7.0	6-862	9/32	7.14	95 x 34	41 g	
6-826	8.0	6-863	5/16	7.94	100 x 36	60 g	
6-827	9.0	6-864	11/32	8.73	105 x 38	81 g	
6-828	10.0	6-865	3/8	9.53	112 x 40	105 g	

6-810 8-piece wrench key set

offset model, on ring

Contents: 8 wrench keys 2.0–2.5–3.0–4.0–5.0–6.0–8.0–10.0 mm

Weight: 255 g

6-820 8-piece wrench key set

offset model, in a plastic wallet

Contents: 8 wrench keys 1.5–2.0–2.5–3.0–4.0–5.0–5.5–6.0 mm

Weight: 100 g

Wrench keys without handles

with fitting tangs (figure 6-830)

Material: chrome vanadium, burnished, tangs nickel-plated

No.	A/F mm	No.	Inches	A/F ≈ mm	Blade length mm	Weight
6-832	1.2	6-872	1/16	1.59	140	16 g
6-833	1.5	6-873	5/64	1.98	140	16 g
6-834	2.0	6-874	3/32	2.38	140	17 g
6-835	2.5	6-875	1/8	3.18	140	18 g
6-836	3.0	6-876	9/64	3.56	140	19 g
6-837	4.0	6-877	5/32	3.97	140	28 g
6-838	4.5	6-878	3/16	4.76	140	30 g
6-839	5.0	6-879	7/32	5.56	140	32 g
6-841	6.0	6-881	1/4	6.35	140	42 g

6-830 11-piece wrench key set in a plastic wallet

Contents: 10 wrench keys 1.0–1.2–1.5–2.0–2.5–3.0–4.0–4.5–5.0–6.0 mm

1 spring handle in impact-resistant, transparent yellow plastic No. 4-775

Weight: 290 g

Sets of wrench keys (imperial dimensions)

6-840 10-piece wrench key set on ring

Contents: 10 wrench keys 1/16–5/64–3/32–1/8–5/32–3/16–7/32–1/4–5/16–3/8"

Weight: 220 g

6-880 8-piece wrench key set in a plastic wallet

Contents: 8 wrench keys 1/16–5/64–3/32–1/8–5/32–3/16–7/32–1/4"

Weight: 100 g

6-890 11-piece wrench key set in a plastic wallet

Contents: 10 wrench keys 3/64–1/16–5/64–3/32–1/8–9/64–5/32–3/16–7/32–1/4"

1 spring handle in impact-resistant, transparent yellow plastic No. 4-775

Weight: 315 g

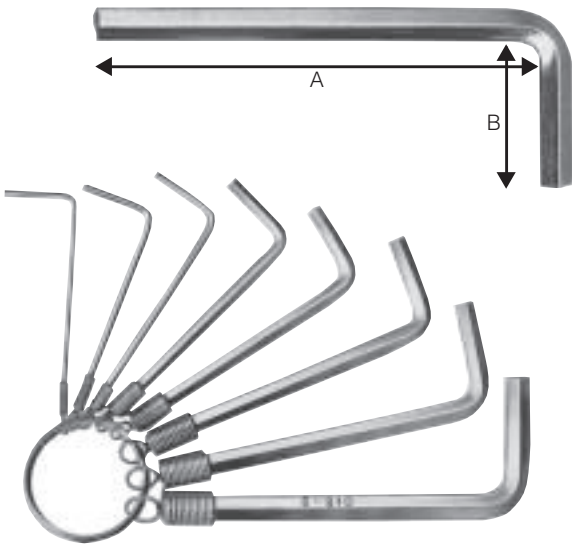

SPECIAL WRENCHES

Wrench keys

straight model and offset model to DIN 911

Blade: chrome vanadium, nickel-plated

Handle: impact-resistant, transparent plastic

Straight finish No.	A/F mm	Blade length mm	Weight	Offset finish No.	Leg length mm		Weight	Handle size mm
					A	B		
6-901	2.0	75	15 g	6-921	75 x 16	15 g	70 x 15	
6-902	2.5	75	17 g	6-922	75 x 18	17 g	70 x 15	
6-903	3.0	75	20 g	6-923	75 x 20	20 g	70 x 15	
6-904	4.0	75	30 g	6-924	75 x 25	35 g	80 x 17	
6-905	5.0	80	55 g	6-925	80 x 28	55 g	80 x 17	
6-906	6.0	80	60 g	6-926	80 x 32	70 g	90 x 20	
6-907	7.0	80	70 g	6-927	80 x 34	100 g	90 x 20	
6-908	8.0	120	115 g	6-928	120 x 36	130 g	100 x 23	
6-909	9.0	120	135 g	6-929	120 x 38	170 g	100 x 23	
6-911	10.0	120	180 g	6-931	120 x 40	210 g	110 x 26	
6-912	12.0	120	240 g	6-932	150 x 45	345 g	120 x 28	



Ballpoint wrench keys

with special square pattern Bernstein handle

Blade: chrome vanadium, hardened over its full length, chrome-plated

Handle: impact-resistant, transparent plastic

No.	Blade length mm	A/F mm	Handle size mm	Weight
6-941	100	3.0	86 x 19	34 g
6-942	100	4.0	86 x 19	41 g
6-943	100	5.0	92 x 21	56 g
6-944	125	6.0	110 x 25	100 g
6-945	150	8.0	110 x 25	146 g
6-946	150	10.0	110 x 25	194 g



6-950 8-piece ballpoint wrench key set, in a plastic wallet

Material: chrome vanadium, burnished, offset model

Contents: 8 wrench keys 1.5 – 2.0 – 2.5 – 3.0 – 4.0 – 5.0 – 6.0 – 8.0 mm

Weight: 210 g



TORX-screwdrivers

with special square pattern Bernstein handle

Blade: chrome vanadium, hardened over its full length, chrome-plated, black tip

Handle: impact-resistant, transparent plastic, amber coloured

No.	Size	Blade length mm	for metric thread	Handle size mm	Weight
6-961	T 6	50	M 2	86 x 19	32 g
6-962	T 7	50	M 2.5	86 x 19	32 g
6-963	T 8	60	M 2.5	86 x 19	32 g
6-964 L	T 9	60	M 3	92 x 21	44 g
6-965 L	T 10	80	M 3-3.5	92 x 21	46 g
6-966 L	T 15	80	M 3.5-4	92 x 21	46 g
6-967 L	T 20	100	M 4-5	100 x 23	61 g
6-968 L	T 25	100	M 4.5-5	100 x 23	63 g
6-969 L	T 27	115	M 4.5-5-6	110 x 25	85 g
6-971 L	T 30	115	M 6-7	110 x 25	95 g

from size T 9 with bore-hole in the tip

very long TORX-screwdrivers

6-974	T 8	100	M 2.5	86 x 19	34 g
6-975	T 10	300	M 3-3.5	92 x 21	60 g

6-995 8-piece TORX-wrench keys with bore-hole in a plastic box

Material: chrome vanadium, burnished, offset model

Contents: 8 TORX-wrench keys T 9, T 10, T 15, T 20, T 25, T 27, T 30, T 40

Weight: 200 g



SAFETY TOOLS

BERNSTEIN-VDE-socket wrenches and VDE-wrench keys are monitored by the VDE Test Centre.

Random samples are taken and type tests are performed in accordance with the regulations.

Permissible voltage at which the VDE socket wrenches and wrench keys can be used:

1000 V a.c. or 1500 V d.c.

The handle and blade insulation is moulded in one piece and is therefore permanently connected.



Safety insulated socket wrenches

to VDE regulations EN 60.900

Blade: chrome vanadium, hardened over its full length, to DIN 7445

Handle: impact-resistant, red coated plastic

No.	A/F mm	Blade length mm	Handle size mm	Weight
16-402 VDE	5.5	125	100 x 24	75 g
16-403 VDE	6.0	125	100 x 24	75 g
16-404 VDE	7.0	125	110 x 26	105 g
16-405 VDE	8.0	125	110 x 26	105 g
16-406 VDE	9.0	125	110 x 26	110 g
16-407 VDE	10.0	125	110 x 26	110 g
16-408 VDE	11.0	125	125 x 30	150 g
16-409 VDE	12.0	125	125 x 30	150 g
16-411 VDE	13.0	125	125 x 30	155 g



Safety insulated wrench keys

to VDE regulations EN 60.900

Blade: chrome vanadium, hardened over its full length, burnished, to DIN 7439

Handle: impact-resistant, red coated plastic

No.	A/F mm	Blade length mm	Handle size mm	Weight
16-701 VDE	2.5	75	100 x 24	35 g
16-702 VDE	3.0	75	100 x 24	40 g
16-703 VDE	4.0	75	100 x 24	45 g
16-704 VDE	5.0	75	110 x 26	65 g
16-705 VDE	6.0	100	110 x 26	80 g
16-706 VDE	8.0	100	125 x 30	130 g



Single-ended open-jaw wrenches

to DIN 7446, with two-colour multilayered insulation, 1000 V

No.	A/F mm	Weight	No.	A/F mm	Weight
16-501 VDE	6.0	25 g	16-507 VDE	12.0	65 g
16-502 VDE	7.0	25 g	16-508 VDE	13.0	75 g
16-503 VDE	8.0	35 g	16-509 VDE	14.0	95 g
16-504 VDE	9.0	40 g	16-511 VDE	15.0	100 g
16-505 VDE	10.0	50 g	16-512 VDE	17.0	110 g
16-506 VDE	11.0	55 g	16-513 VDE	19.0	185 g



Single-ended ring wrenches

to DIN 7447, with two-colour multilayered insulation, 1000 V

No.	A/F mm	Weight	No.	A/F mm	Weight
16-531 VDE	6.0	45 g	16-536 VDE	11.0	90 g
16-532 VDE	7.0	50 g	16-537 VDE	12.0	130 g
16-533 VDE	8.0	55 g	16-538 VDE	13.0	135 g
16-534 VDE	9.0	60 g	16-539 VDE	14.0	160 g
16-535 VDE	10.0	85 g	16-541 VDE	15.0	165 g

– other dimensions available on request –

16-440 VDE 9-piece set of sockets

in red imitation leather case

Contents: 8 sockets with two-colour multilayered insulation

A/F: 10.0 – 11.0 – 12.0 – 13.0 – 14.0 – 15.0 –

17.0 – 19.0 mm

1 T-socket wrench, 1/2" square drive, 200 mm with two-colour multilayered insulation

Weight: 1.120 kg



TOOLS

Engineer's hammers

with lacquered wooden handle

No.	Length mm	Head weight	Total weight
7-102	265	100	170 g
7-104	285	200	280 g
7-106	300	300	400 g
7-109	320	500	590 g

Engineer's hammers to DIN 1041

swaged, accurately slided, stem and path finish grinded, lacquered and rustproof, with lacquered ash-handle

7-112	260	100	155 g
7-114	280	200	260 g
7-116	300	300	435 g
7-119	320	500	615 g

Plastic hammers

with impact-resistant, cellidor plastic tops, lacquered wooden handle

No.	Head-Ø mm	Length mm	Weight
7-121	22	255	130 g
7-122	27	265	225 g
7-123	32	285	330 g

Firmer chisels to DIN 5139, with impact-resistant wooden handle

No.	Blade width mm	Blade length mm	Total length mm	Weight
7-201	10	120	235	90 g
7-202	16	130	240	130 g
7-203	20	140	250	155 g

Flat chisels

similar to DIN 6453, chrome vanadium, safety impact head

No.	Head width mm	Length mm	Ø mm	Weight
7-215	10	100	8	45 g
7-225	16	150	12	125 g
7-235	20	200	16	310 g

Electrician's chisels

chrome vanadium, safety impact head

7-245	8	200	6	55 g
7-255	10	200	8	95 g

Centre-punch to DIN 7250, chrome vanadium, safety impact head

No.	Head-Ø mm	Length mm	Ø mm	Weight
7-281	5.0	120	12	90 g

Twist gimlets

black lacquered, with knurled ring handle

No.	Bore-Ø mm	Length mm	Weight
7-303	3.0	125	10 g
7-304	4.0	140	20 g
7-306	6.0	170	30 g

Drill saw

with plastic handle

Nr.	Bore-Ø mm	Blade length mm	Total length mm	Weight
7-311	5.0	170	270	55 g
7-312	6.5	230	360	110 g

Drill rasp

with plastic handle

7-315	4.0	175	260	35 g
-------	-----	-----	-----	------

Punch

with impact-resistant plastic handle

No.	Blade-Ø mm	Blade length mm	Total length mm	Weight
7-316	6.0	100	185	75 g



TOOLS – OILER

Trowel with conical forged blade and wooden handle

No.	Blade width mm	Total length mm	Weight
7-405	50	200	65 g

Slicker trowel polished with round shank

7-410	16	220	25 g
-------	----	-----	------

Rubber beaker for plaster (without picture) round, conical form

No.	Ø mm	Height mm	Weight
7-415	130	95	125 g

Dust brush

with white bristles and plastic handle

No.	Bristles length mm	Bristles width mm	Total length mm	Weight
7-425	40	25	195	10 g

ESD/EGB-brush

with **conductive** handle, **natural** bristles with **conductive** fibres

No.	Typ	Bristles	Total length mm	Weight
7-421	round	6 mm Ø	150	7 g
7-422	flat	20 mm wide	150	26 g

Oiler

made from transparent plastic with brass rotating seal

No.	Contents ccm	Total length mm	Weight
7-435	20	110	15 g

Oiler

made from transparent plastic, with plastic seal

7-445	20	110	6 g
-------	----	-----	-----

Drip oiler

for droplet oiling

7-438	5	140	20 g
-------	---	-----	------

MEASURING TOOLS

Folding rule from wood, with steel spring

No.	Length m	Width mm	Weight
7-502	2	15.0	112 g

Tape measure

with impact-resistant plastic housing, steel tape for pulling out and in

7-505	1	6.5	18 g
7-506	2	13.0	71 g

Steel tape measure

stainless, lines and numbers etched and blank coloured

No.	Length mm	Cross section mm	Weight
7-508	300	13 x 0.5	16 g

Precision caliper square

hardened, stainless, with open slide and quick clamping, in a wallet

No.	Measuring range mm	Nose mm	Nonius mm	Weight
7-511	160	40	1/20	186 g

Miniature caliper square

hardened, stainless, with open slide and adjusting screw, in wallet

7-512	100	20	1/20	84 g
-------	-----	----	------	------



MEASURING TOOLS

Feeler gauge with conical leaves

No.	Measuring range mm	Blade length mm	Blade quantity	Weight
7-515	0.10 - 2.0	100	20	171 g

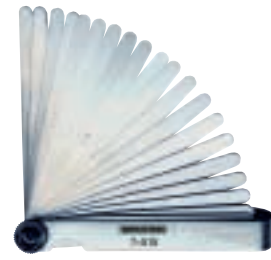

Scriber

with roughened nickeled handle, needles hardened and burnished, interchangeable

No.	Handle-Ø mm	Needles-Ø mm	Total length mm	Weight
7-521	6	2.5	200	26 g



Square for mechanics with bevel, plate, fine polished

No.	Sides of angle mm	Weight
7-523	150 x 100	250 g

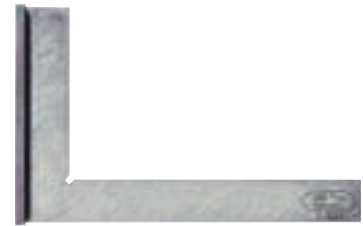

Spirit level, made from plastic

with 3 levels: horizontal, vertical and 45° angle

No.	Length mm	Weight
7-535	220	58 g



SAWS

No.	Blade length mm	Length mm	Weight
-----	-----------------	-----------	--------

Hack saw frame from flat steel for sawblades of 300 mm length, with saw blade

7-605	300	530	515 g
-------	-----	-----	-------



Hack saw blade both ends toothed, from Wolfram-steel

7-606	300	44 g
-------	-----	------

Pocket hack saw „Puk“ with fixed wooden handle and saw blade for wood and metal

7-615	150	300	94 g
-------	-----	-----	------



Pocket hack saw „Puk“ with adjustable wooden handle, with saw blade for wood and metal, in a plastic wallet

7-616	150	300	130 g
-------	-----	-----	-------

Hack saw blade special for „Puk“ hack saws and pocket hack saw 7-620

7-617	150	3 g
-------	-----	-----

Pocket hack saw with plastic handle and saw blade for wood and metal

7-620	150	260	215 g
-------	-----	-----	-------



PROTECTION SPECTACLE

Protection spectacle with colourless glasses from plastic, acc. to DIN-regulations

7-651	68 g
-------	------





BERNSTEIN

Electronic-Tools

Quality for the specialist



CLAMPING VICES SPANNFIX

BERNSTEIN clamping equipment is constructed on ball-and-socket joints, thus enabling it to be rotated and set firmly, in order to create maximum possibilities for work.

Small vice on ball-and-socket joint rotatable in any direction and capable of being set securely.

The "Spannfix" vice simplifies many jobs in precision engineering, in laboratories, in test rooms and all engineering and electronics workshops.



9-205



9-215



9-261



9-220



9-220



9-210



9-211

9-205 **BERNSTEIN SPANNFIX** screw-on vice

for work benches with a max. table thickness of 80 mm.

The small vice with ball-and-socket joint can be mounted quickly and easily onto a work bench or table. Slight pressure on the lever is sufficient, and the clamped workpiece can be moved into any suitable position.

Technical data:	Clamping pressure	150 kp
	Clamping capacity	70 mm
	Clamping depth	38 mm
	Jaw width	50 mm
	Jaws (interchangeable)	plastic

Weight: 1.450 kg

9-215 **BERNSTEIN SPANNFIX** for permanent mounting using bolts

Technical data: as 9-205

Size of base: 150 x 105 mm

Weight: 1.350 kg

9-261 **SPANNFIX** bench mounted base with universal ball joint and threaded stud M 12 x 1.5 for permanent mounting using bolts

Size of base: 150 x 105 mm

Weight: 0.800 kg

9-220 **BERNSTEIN SPANNFIX VICE** WITH VACUUM BASE for portable applications

Technical data: as 9-205

Size of base: 150 x 105 mm

Weight: 2.000 kg

9-210 **SPANNFIX VACUUM BASE** with ball joint and threaded stud M 12 x 1.5

(consisting of 9-211 and 9-261)

Weight: 1.500 kg

9-211 **SPANNFIX VACUUM BASE** only

to be used in conjunction with 9-215 or 9-261

Weight: 0.650 kg

CLAMPING EQUIPMENT SPANNFIX COMBINATIONS

9-250 **BERNSTEIN SPANNFIX-VARIO** assembly vice

5 piece set
with interchangeable screw-on work mounts
Weight: 2.000 kg

Description of individual components:

9-251 **Universal clamp mounting ball joint base**
for screwing onto work benches with a max. table thickness
of 80 mm
Weight: 0.950 kg

9-252 **Screw-on mounting vice**
Technical data: Clamping pressure 150 kp
Clamping capacity 70 mm
Clamping depth 38 mm
Jaw width 50 mm
Jaws (interchangeable) plastic
Weight: 0.560 kg

9-253 **Circuit board holder**
adjustable from 25 mm to 270 mm clamping capacity, can be
extended as required at any time, correct setting by adjusting
the centre position, protected against contact voltages, firm
clamping of the printed circuit by built-in resilience in the
locating arms, height of locating arms 70 mm.
Weight: 0.280 kg

If the circuit board holder is to be used with universal ball joint
base 9-251, we recommend that the combination is used with
angular adapter 9-255 or with rapid turning device 9-257 in order
to obtain a larger turning circle.

9-254 **Universal screw-on plate**
Slots made for commonly used standard bolts, for holding of e. g.
tuner, line output transformer, small loudspeaker etc. or prototypes
Weight: 0.120 kg

9-255 **Angular adapter**
to be used as an additional attachment with every work mount,
permits an even larger turning circle.
Weight: 0.095 kg

9-260 **BERNSTEIN SPANNFIX-VARIO** assembly vice

5-piece set
comparable with 9-250
only 9-251 Universal clamp ball joint base is changed into 9-261
Weight: 2.000 kg

9-261 **SPANNFIX bench mounted base with universal ball joint and
threaded stud M 12 x 1.5 for permanent mounting using bolts**
Size of base: 150 x 105 mm
Weight: 0.800 kg

All parts can also be obtained individually.



CLAMPING EQUIPMENT SPANNFIX COMBINATIONS

9-270 **BERNSTEIN** SPANNFIX-VARIO-PLUS clamping combination

Tailor-made combination of the following individual components:

- 9-251 Clamp mounting ball joint base
 - 9-257 Rapid turning device with permanently connected angular adapter
 - 9-253 Circuit board holder
 - 9-256 Clamping lid for circuit boards with components
- Weight: 1.800 kg



Accessories for the SPANNFIX-VARIO assembly vice

- 9-256 **Clamping lid for circuit boards with components**
covered with 20 mm thick foamed plastic. Components of different sizes are pressed in such a way that soldering can be carried out correctly after the circuit board holder has been turned.

Size of cover: 240 x 130 mm
Use: in conjunction with circuit board holder 9-253
Weight: 0.260 kg

- 9-257 **Rapid turning device**
with permanently connected angular adapter, permits swift rotation of the circuit board holder with the PCB and clamping lid through 180°.

Weight: 0.270 kg

- 9-263 **Large circuit board holder**
for industrial purposes
clamping width adjustable from 25 mm to 310 mm, clamping height up to 350 mm, correct setting by adjusting the centre position, protected against contact voltages, firm clamping of the circuit board through built-in resilience of the locating arms.

Weight: 0.400 kg

- 9-266 **Clamping lid for large circuit board holder**
robust version for industrial purposes
construction as 9-256

Size of cover: 315 x 330 mm
Use: in conjunction with circuit board holder 9-263
Weight: 0.900 kg

Accessories for SPANNFIX VICE

9-230 **ALLSPANN clamping device**

(patent applied for)
with rapidly interchangeable loose tools

Technical data:	Clamping capacity	approx. 370 mm
	Jaw width	160 mm
	Distance between uprights	65 and 130 mm
	Height of uprights	150 mm

Weight: 2.100 kg

"ALLSPANN" is an accessory for the Spannfix vice to enable the clamping capacity, clamping depth and jaw width to be extended and which, in addition, also permits the clamping of irregularly shaped bodies or workpieces.



9-256



9-257



9-263



9-230

CLAMPING VICES MAXI

Heavy-duty vice on ball-and-socket joint rotatable in any direction and capable of being set securely.

The same functioning as the Spannfix small vice also distinguishes the large models. To be used when working on larger and heavier workpieces.

9-225 **BERNSTEIN SPANNFIX VICE MAXI screw-on**

for work benches with a max. table thickness of 85 mm.

Technical data:	Clamping pressure	300 kp
	Clamping capacity	100 mm
	Clamping depth	50 mm
	Jaw width	100 mm
	Jaws (rotatable) steel, smooth and fluted (other clamping jaws on request)	

Weight: 4.000 kg



9-225

9-226 **BERNSTEIN SPANNFIX VICE MAXI** for permanent mounting using bolts

Technical data: as 9-225
Size of base: 190 x 155 mm
Weight: 3.600 kg



9-226

SPANNFIX FOR SPECIAL USE

9-227 **SPANNFIX MAXI universal clamp** mounting ball joint base, with threaded stud M 12 x 1.5 for screwing onto work benches with a max. table thickness of 85 mm.

Weight: 2.220 kg



9-227

9-228 **SPANNFIX MAXI bench mounted base** with universal ball joint and threaded stud M 12 x 1.5 for permanent mounting using bolts

Size of base: 190 x 155 mm
Weight: 1.850 kg



9-228

ESD-COVERINGS AND ACCESSORIES



9-342

9-343



9-356



9-357

9-359



9-361

9-342 Contact bracelet with spiral cord

adjustable elastical bracelet with woven silvered synthetic fibres, allergy-free, with 3 mm press-stud; high elastical spiral cord, 2400 mm long, 2 x 1 Mohm safety resistor, press-studs 3 mm for bracelet and 10 mm for earth wire; additionally insulated crocodile clip for terminal connection No. 9-353. (Weight: 60 g)

9-343 Earth wire

with 1 Mohm safety resistor, 1500 mm long, with 2 press-studs 10/10 mm, for connecting workbench pad and floor cover and connection to an earth potential; additionally insulated crocodile clip No. 9-535. (Weight: 40 g)

9-345 Floor cover

2000 x 1200 x 2.2 mm, **pebble grey**, with homogeneous, electrostatic conductive rear, wheelchair-proof, with 2 press-studs 10/10 mm; earth wire 4500 mm long, 1 Mohm safety resistance, with 2 press-studs 10/10 mm, (leakage resistance according to DIN IEC 61340-4-1 R_A : $10^6 - 10^7$ ohm); additionally insulated crocodile clip No. 9-353. (Weight: 7850 g)

9-346 Earth wire

with 1 Mohm safety resistance, 2500 mm long, mit 2 press-studs 10/10 mm, for connecting workbench pad and floor cover and connection to an earth potential; additionally crocodile clip for terminal connection No. 9-353. (Weight: 50 g)

9-351 ESD-handling set

consisting of:
workbench pad, 900 x 600 x 2.2 mm, **pebble grey**, with homogeneous, electrically conductive rear, (leakage resistance to DIN IEC 61340-4-1 R_A : $10^6 - 10^7$ ohm), with 2 press-studs 10/10 mm; contact bracelet No.9-342, earth wire No. 9-343 including crocodile clip No. 9-353. (Weight: 1850 g)

9-353 Crocodile clip

insulated clip with banana plug connection socket and 10 mm press-stud. (Weight: 20 g)

9-354 ESD-handling set foldable - especially for mobile use

consisting of:
workbench pad, 500 x 400 x 0.35 mm, **green**, electrically conductive, grained surface, (leakage resistance to DIN IEC 61340-4-1 R_A : ca. 10^8 ohm), with 2 press-studs 10/10 mm; contact bracelet No. 9-342, earth wire No. 9-346 including crocodile clip No. 9-353. (Weight: 160 g)

9-355 ESD-handling set foldable - especially for mobile use

consisting of:
workbench pad, 800 x 600 x 0.2 mm, **black**, electrically conductive, (leakage resistance to DIN IEC 61340-4-1 R_A below 10^6 ohm); contact bracelet No. 9-342, earth wire No. 9-346 including three crocodile clips No. 9-353. (Weight: 240 g)

9-356 ESD-handling set foldable - especially for mobile use

consisting of:
workbench pad with 2 patch pockets, 680 x 680 x 0.35 mm, **green**, electrically conductive, grained surface, (leakage resistance to DIN IEC 61340-4-1 R_A : ca. 10^8 ohm), with three press-studs 10/10/10 mm; contact bracelet No. 9-342, earth wire No. 9-346 including crocodile clip No. 9-353. (Weight: 480 g)

9-357 Earthing module

earthing box with 2 x 10 mm press-stud inputs and 1 x 4 mm safety socket input, per input 1 Mohm safety resistance, earth wire 2000 mm, with dummy Schuko-plug. (Weight: 90 g)

9-359 Earth wire with dummy Schuko-plug

spiral cord 2400 mm long, 1 Mohm safety resistance, one side press-stud 10 mm, other side dummy Schuko-plug. (Weight: 90 g)

9-360 ESD-handling set

consisting of:
workbench pad, **resistant to soldering tin**, 800 x 600 x 1.5 mm, **black**, from homogeneous, electrically conductive synthetic caoutchouc, slightly grained surface, (leakage resistance to DIN IEC 61340-4-1 R_A : $10^5 - 10^6$ ohm), with 2 press-studs 10/10 mm; contact bracelet No. 9-342, earth wire No. 9-343 including crocodile clip No. 9-353. (Weight: 1100 g)

9-361 ESD-handling set

consisting of:
workbench pad, **resistant to soldering tin**, 800 x 600 x 2.0 mm **platinum grey**, from conductive synthetic caoutchouc, slightly grained, with homogeneous, electrically conductive black rear, (leakage resistance to DIN IEC 61340-4-1 R_A : $10^5 - 10^7$ ohm), with 2 press-studs 10/10 mm; contact bracelet No. 9-342, earth wire No. 9-343 including crocodile clip No. 9-353. (Weight: 1300 g)

ESD COVERINGS AND ACCESSORIES

especially for EDP and cash-register

The workbench pads consist of antistatic synthetic caoutchouc, with homogeneous, conductive, black rear. The surface is slightly grained. The synthetic caoutchouc material is very wear- and heat-resistant, nonskid and lies very flat.

Technical data: material thickness 2 mm
leakage resistance (DIN IEC 61340-4-1) R_A : $10^5 - 10^7$ ohm
time of discharge from 5000 to 50 Volt: < 2 Sec.

Colour: **platinum grey**

- 9-348 **ESD set** / pad 800 x 600 mm
especially for cash-register, EDP-terminals
consisting of:
workbench pad with 1 press-stud 10 mm for the earthing connection;
earth wire No. 9-346 including crocodile clip No. 9-353. (Weight: 1350 g)
- 9-365 **ESD set** / pad 600 x 300 mm
especially for keyboards
consisting of:
workbench pad with 2 press-studs 10/10 mm for connecting the earth wire and
the junction to the mousepad; earth wire with dummy Schuko-plug No. 9-359.
(Weight: 550 g)
- 9-367 **ESD set** / pad 600 x 450 mm
especially for CPU (central processing units), printer, scanner
consisting of:
workbench pad with 1 press-stud 10 mm for the earthing connection;
earth wire with dummy Schuko-plug No. 9-359. (Weight: 750 g)
- 9-368 **ESD set** / pad 600 x 600 mm
especially for CPU (central processing unit), printer, scanner
consisting of:
workbench pad with 1 press-stud 10 mm for the earthing connection;
earth wire No. 9-346 including crocodile clip No. 9-353. (Weight: 930 g)



9-365

ESD ACCESSORIES

Grid mats made from solid rubber

repair support, in conductive execution, according to DIN 482

- 9-335 Grid mat size I, measure: 625 x 375 x 20 mm Weight: 2500 g
- 9-336 Grid mat size II, measure: 700 x 450 x 20 mm Weight: 3350 g

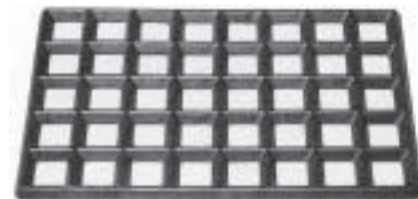

9-335

Boxes for SMD components

from black, conductive plastic, to be fit into one another at random, hinged cover, closed tightly by spring pull, in 3 different sizes

- 9-321 SMD box 16 x 12 x 15 mm (internal dimensions) Weight: 5 g
- 9-322 SMD box 37 x 12 x 15 mm (internal dimensions) Weight: 10 g
- 9-323 SMD box 41 x 37 x 15 mm (internal dimensions) Weight: 15 g

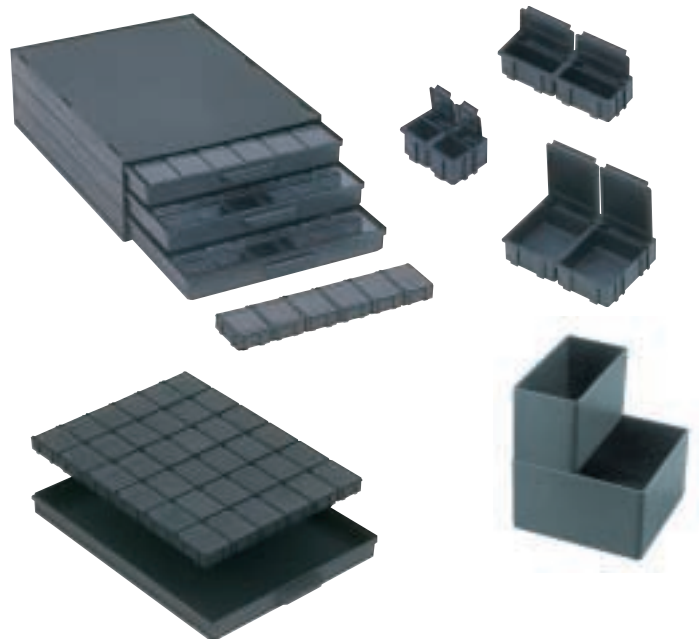

Cabinet for SMD boxes

9-320 from black, conductive plastic, with 3 removable drawers, each 340 x 250 x 22 mm suitable for:

- 432 boxes No. 9-321 (144 per drawer)
- 216 boxes No. 9-322 (72 per drawer)
- 108 boxes No. 9-323 (36 per drawer)

Weight: 1900 g

Storage boxes

electrically conductive interchangeable containers, black

- 9-311 box 108 x 54 x 63 mm (external dimension) Weight: 40 g
- 9-312 box 108 x 108 x 63 mm (external dimension) Weight: 70 g

Chip-container

electrically conductive, black, with lid a pin-cushion lining 5 mm thick, for pins of electrostatically endangered components

- 9-316 chip-container 118 x 32 x 14 mm (internal dimensions) Weight: 30 g
- 9-319 chip-container 54 x 25 x 14 mm (internal dimensions) Weight: 10 g



ESD/EGB tools please see the special sides in the article groups screwdriver, pliers, tweezers und socket wrenches resp. complete sets of conductive tools under service cases/service boxes.

MAGNIFYING LAMPS

Magnifying lamp with lens-cover and glare-protection

for 22 W fluorescent light source
with ideal viewing conditions
without excessive heat

Robust arm construction. Two spring-balanced arms with parallel movement. Springs and all moving mechanical parts built into the tubes and covered. The springs are of high-grade tempered steel calibrated to ensure perfect arm balance; with insulated parts in the joints for safety reasons. Qualified for vibrant working-places.

Technical data: Arm length: from bracket to center of lens 120 cm fully extended, reflector-Ø: 23 cm, lens-Ø: 125 mm, lens: fixed 3 diopter bi-convex, magnification: 1 : 1 3/4 or 175 % at a working-distance of 25 cm, Schuko-contact-cable 1.5 m, protection class I. Through additional lens approx. magnification of 1 : 3 3/4 or 375 % possible. Colour: pearl grey

- 9-100 **Magnifying lamp with stand trolley and sliding bracket**
- 9-101 **Magnifying lamp with bracket (table) standard**
- 9-102 **Magnifying lamp with bracket (wall)**
- 9-103 **Magnifying lamp with bracket (screw-down mount)**
- 9-105 **Magnifying lamp with bracket (drawing-board or any slanting surface)**

All lamps will be delivered without circular fluorescent tube.

Accessories:

- 9-106 **5-feet-stand with trolley and sliding bracket**
- 9-107 **Additional lens 4 diopter, magnification 1 : 2 3/4**
- 9-108 **Additional lens 8 diopter, magnification 1 : 3 3/4**
- 9-109 **Fluorescent ring lamp 22 W, white**

Magnifying lamp with plastic reflector

for 22 W fluorescent ring light

Good equilibrated arm construction enables maximal setting. It's easy to bring this lamp in the wanted position by the open spring-balanced arms.

Technical data: Total arm length: 105 cm, reflector-Ø 22 cm, lens-Ø 125 mm, lens: fixed 3.0 diopter bi-convex, magnification: 1 : 1 3/4 or 175 %, at a working-distance of 25 cm, Schuko-contact-cable 2.5 m, protection class I, fluorescent tube protected by prism cover. Colour: light grey

- 9-191 **Magnifying lamp with bracket (table) standard**
- 9-192 **Magnifying lamp with bracket (wall)**
- 9-193 **Magnifying lamp with bracket (screw-down mount)**
- 9-195 **Magnifying lamp with bracket (drawing-board or any slanting surface)**

All lamps will be delivered without circular fluorescent tube.

- 9-109 **Fluorescent ring lamp 22 W, white**



MAGNIFYING LAMPS OFFICE LAMPS

Magnifying lamp with plastic reflector

for compact fluorescent tube 9 W

Four-tube spring balanced arm from lacquered steel pipe, open chrome-plated springs, twist protection, 1.5 m cable, protection class II.

Technical data: Total arm length 96 cm, table version 60 cm, lens 150 x 60 mm, 3 diopter, magnification 1: 1 3/4 at a working-distance of 20 cm, reflector 220 x 160 mm.

Colour: white

9-171 **Magnifying lamp with table stand**

9-172 **Magnifying lamp with bracket**

All lamps will be delivered without tubes.

Accessories:

9-179 **Fluorescent tube 9 W**



Magnifying lamp with plastic reflector

for 40 W incandescent bulb

Four-tube spring balanced arm from lacquered steel pipe, open chrome-plated springs, twist protection, 1.5 m cable, protection class II.

Technical data: Total arm length 95 cm, lens-Ø 100 mm, 3 diopter, magnification 1: 1 3/4 at a working-distance of 20 cm.

Colour: white

9-181 **Magnifying lamp with bracket (table) standard**

9-182 **Magnifying lamp with bracket (wall)**

9-183 **Magnifying lamp with bracket (screw-down mount)**

All lamps will be delivered without incandescent bulb.



Office and industry lamp

for 15 W fluorescent tubes (2 pieces)

The reflector is designed to distribute a shadow-free light over a large area with a minimum of heat and glare. The two 15 W fluorescent tubes give a light output equivalent to that of a 150 W incandescent bulb. The lamp head is mounted on a heavy-duty arm with built-in springs and parts, with insulated parts in the joints, turnable into any position. Qualified for vibrant working-places, Schuko-contact-cable 1.5 m, protection class I.

Technical data: Total arm length 120 cm, reflector 48 x 10 cm.

Colour: white

9-131 **Fluorescent lamp with bracket (table) standard**

9-132 **Fluorescent lamp with bracket (wall)**

9-133 **Fluorescent lamp with bracket (screw-down mount)**

9-135 **Fluorescent lamp with bracket (drawing-board or any slanting surface)**

All lamps will be delivered without fluorescent tubes.

Accessories:

9-139 **Fluorescent tubes 15 W (2 pieces), white**



Office lamp

for halogen lamp 15 W / 12 V base GY 6.35

Four-tube spring balanced arm from thermo lacquered steel pipe, chrome-plated steel springs, reflector with twist protection. Halogen lamp protected by security glass. Intensity of light variable in 2 steps.

Technical data: Total arm length 105 cm, reflector-Ø 90 mm, 1.8 m cable, protection class II

Colour: black

9-116 **Office lamp with bracket inclusive halogen lamp 50 W**



MAGNIFIER AND MICROSCOPE



Professional illuminated magnifier
for compact fluorescent tubes 7 W (2 pieces)

This magnifier with rectangular lens permits viewing with both eyes. It is the ideal combination of light and magnifier because of two individual light sources and separate switches for individual operation. With single tube operation, three-dimensional viewing is possible. Shadow-free illumination is provided when both fluorescent tubes are operating.

A spring-balanced arm with parallel motion permits exact positioning of the magnifier making it flexible for every working situation.

Technical data: Arm length: from bracket to center of lens 60 cm Ø, reflector 15 x 29 cm, asymmetrical light distribution, lens 17 x 11 cm, 3 diopter, magnification 1 : 1 3/4 or 175 % at a working distance of 25 cm, Schuko-contact-cable 1.5 m, protection class I.
Colour: light grey

9-121 **Professional illuminated magnifier with table bracket inclusive 2 tubes 7 W**

Accessories:

9-127 **Additional lens 4 diopter, magnification 1 : 2 3/4**

9-128 **Additional lens 8 diopter, magnification 1 : 3 3/4**

9-129 **Fluorescent tubes 7 W (2 pieces)**

Binoskop

Stereomicroscope, tele-magnifier and binoculars in one.

The BINOSKOP is a unique optical device for stereoscopic observation of a wide field of vision. It is thus especially well suited for monitoring details of materials and assembly in SMD technology.

Additional benefits:

- upright picture, vertical and horizontal
- pupillary distance adjustable from 58 to 72 mm
- eye piece individually adjustable for left and right eye with diopter markings
- fully coated lenses, low weight: 540 g



Technical Data	Magnification from/to	Field of vision from/to	Working distance in mm
For use as stereo-microscope with attachment lens	12 x	20 - 35 mm	135 - 185
as telemagnifier	9 x	90 - 135 mm	420 - 750
as binoculars	7 x 25	166 m to 1000 m corresponds to wide angle lens	400 -

9-150 **Binoskop**

SOLDERING EQUIPMENT AND SOLDERING IRONS



8-396



8-396-1

8-396-2

8-396-3



8-399



8-399-1

8-399-2



8-350



8-351



8-120

PORTASOL gas soldering iron

The progressive gas soldering iron is suitable for laboratories, service and production. It is wireless and therefore without inductive voltage, with catalyst, consequently without open flame. Heating up time 20 sec.. One gas filling is sufficient for about 1 hour of working time, then the iron has to be refilled with Butane gas, as used for lighters. The maximum temperature of the gas-heated bit may reach up to 400° C. By the adjustable gas supply the integrated ignition system provides 10 to 60 W of a conventional soldering iron. The cap contains the lighter for the catalytic converter. Spare bits with catalytic converter are easily interchangeable.

8-396 Gas soldering iron

8-396-1	Bit 1.0 mm
8-396-2	Bit 2.4 mm
8-396-3	Bit 3.2 mm

Weller gas soldering iron Pyropen jr.

Butane-gas-operated catalytic soldering iron with very short heating up time. The interchangeable bits allow a wide range of application such as soft soldering, brazing and operations with hot air for the SMD-technique. Temperature control by regulating the gas valve: with soldering bit from about 200 - 450° C and with hot air nozzle up to max. about 430° C. The flame nozzle integrated in the iron is adjustable up to max. about 1300° C.

8-399 Gas soldering set Pyropen jr.

consisting of gas soldering iron with longlife bit 0,5 mm, needle-shaped, Butane gas refill, holder with sponge

8-399-1	Bit 0.5 mm Ø
8-399-2	Hot air nozzle 1.5 mm Ø
	- especially for the SMD-technique

Weller WTCP 50

Magnastat-soldering station 50 W / 24 V, consisting of safety transformer class II, 230 x 24 V, soldering iron TCP-S / 24 V / 50 W, with temperature automatism and longlife bit PTB 7, holder KH-20

8-350 Soldering station WTCP 50

Weller WS 50 antistatic

Temtronic-soldering station with antistatic casing. Electronically controlled soldering station with safety transformer 24 V / 50 VA, stepless temperature adjustment up to 450° C, optical regulation control by a green LED, floating, holder KH-20.

8-351 Soldering station WS 50 antistatic

ERSA Multi-Pro / 25 W

Extremely flexible and efficient microsoldering tool for the mobile use. In addition to conventional applications also suitable for soldering and desoldering of SMT components. Can be equipped with a wide range of soldering tips.

Heating time: up to 300° C in about 125 s; soldering tip temperature: appr. 480° C with soldering tip 832 CD; voltage: 230 V; accessories: tool holder A 18

8-120	Multi-Pro with ERSADUR long-life soldering tip 832 CD	930 CD
8-121	Spare heating element	931 00
	ERSADUR spare soldering tips	
8-212-1	Pencil point, extended, 0,4 mm Ø	832 UD
8-212-2	Pencil point, extended, 0,8 mm Ø	832 SD
8-212-3	Pencil point, 1,0 mm Ø	832 BD
8-212-4	Chisel-shaped, extended, 2,2 mm	832 KD
8-212-5	Chisel-shaped, 2,2 mm	832 CD
8-212-6	Chisel-shaped, 3,2 mm	832 ED
8-212-7	Chisel-shaped, 5,0 mm	832 VD

SOLDERING IRONS AND ACCESSORIES

ERSA fine soldering iron Tip 260 / 16 W

Light and handy soldering iron (16 W) with PTC-heating element and internally heated nickel-plated copper tip. Short heating time (60 s). Tip temperature: 350° C; voltage: 230 V.

8-110	Tip 260 with nickel-plated copper tip	260 BN/230 V/16 W
8-111	Spare heating element	261 00
8-139	Spare soldering tip, angled face, nickel-plated	162 LN
8-140	Spare soldering tip, angled face, ERSADUR	162 LD
8-141	Spare soldering tip, chisel-shaped, nickel-plated	162 KN
8-142	Spare soldering tip, chisel-shaped, ERSADUR	162 KD
8-143	Spare soldering tip, pencil point, nickel-plated	162 BN
8-144	Spare soldering tip, pencil point, ERSADUR	162 BD



8-110

ERSA fine soldering iron Multitip 15 W

Optimal soldering tool for printed circuit boards, small relay connections, wire connection works. Short heating time (60 s), PTC-heating element, internally heated tip. Soldering tip temperature: 350° C; voltage: 230 V.

8-135	Multitip 15 W with nickel-plated copper tip	910 BN/230 V/15 W
8-136	Spare heating element	911 00
	Spare soldering tips: see tip 260	



8-135

ERSA fine soldering iron Multitip 25 W

Powerful soldering tool for medium-sized soldering work on plugs, multiterminal strips and printed circuit boards. Short heating time (60 s), PTC-heating element, internally heated tip. Tip temperature: 450° C; voltage: 230 V.

8-155	Multitip 25 W with nickel-plated copper tip	920 BN/230 V/25 W
8-156	Spare heating element	921 00
8-159	Spare soldering tip, angled face, nickel-plated	172 LN
8-160	Spare soldering tip, angled face, ERSADUR	172 LD
8-161	Spare soldering tip, chisel-shaped, nickel-plated	172 KN
8-162	Spare soldering tip, chisel-shaped, ERSADUR	172 KD
8-163	Spare soldering tip, pencil point, nickel-plated	172 BN
8-164	Spare soldering tip, pencil point, ERSADUR	172 BD



8-155

ERSA universal soldering iron 30 S (30/40 W)

Universal soldering iron with practical supportable ring and nickel-plated copper tip tested a million times over. Rating: 30 (40) W; heating time: approx. 2 min; tip temperature: 380 (420)° C; voltage: 230 V.

8-145	ERSA 30 S with nickel-plated copper tip	330 KN 230 V/30 W
8-146	Spare heating element	331 00
8-147	ERSA 30 S with nickel-plated copper tip	340 KN 230 V/40 W
8-148	Spare heating element	341 00
8-149	Spare soldering tip, chisel-shaped, nickel-plated	032 KN
8-150	Spare soldering tip, chisel-shaped, ERSADUR	032 KD
8-151	Spare soldering tip, angled face, nickel-plated	032 JN
8-152	Spare soldering tip, angled face, ERSADUR	032 JD



8-145



8-147

ERSA electronic temperature-controlled soldering iron TC 65

The electronic temperature-controlled soldering iron TC 65 (Voltage: 230 V) with POWER button has in the handle an electronic temperature control integrated for stepless temperature setting of the soldering tips 200-440° C and the performance spectrum can be compared with a soldering station (ceramic PTC-heating element, internally heated tips). The POWER button enables an immediate heat-up from the working temperature to the maximum value. The performance spectrum can be compared with soldering irons of 15 W to 100 W.

8-175	Electronic temp.-controlled soldering iron with ERSADUR-soldering tip	650 KD
8-176	Spare heating element	651 00
	Spare soldering tips: see tip 260	



8-175

SOLDERING IRONS AND ACCESSORIES



8-311

ERSA high-speed soldering gun Multi-Sprint

Unusually light and transformer-independent soldering gun with internally heated ERSADUR long-life soldering tip. Extremely short warm-up and cooling-off time. Optimal soldering equipment for service and maintenance purpose. Cold rating: approx. 150 W - heated rating: approx. 75 W, heating time: approx. 20 s, voltage: 230 V

8-311	High-speed soldering gun Multi-Sprint with ERSADUR long-life soldering tip 832 ED	960 ED
8-312	Spare heating element	96100
	Spare soldering tips: see Multi-Pro	



8-180

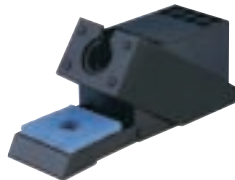

8-185

ERSA holder

For safe and ergonomic placement of soldering irons.

8-180	For small and medium soldering irons	A 05
8-185	For Multitip-series, Multi-Pro, Basic tool 60 and 80	A 28
8-186	Antistatic, for Tip tool, Power tool, Ergo tool, Micro tool und Tech tool	A 29
8-299-0	Antistatic for SMD desoldering pincette 40 430 EDJ	A 30
8-187	For desoldering tool X-Tool 720 ENJ	A 36

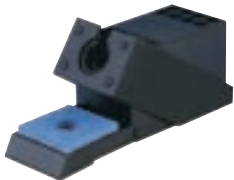

8-186

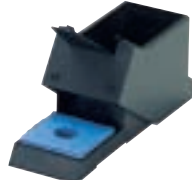

8-299-0

SOLDERING STATIONS AND ACCESSORIES

ERSA electronic temp.-controlled soldering station ANALOG 60 (60 W).

Temperature control by means of ERSERISTRONIC (PTC-heating element). A potential equalization jack ensures the respective safety of the components. The multifunctional holder with cleaning sponge and swivelling sponge base can be used as a tip and tool holder. ERSADUR long-life soldering tips are now non-turnable. Technical data: rating: 60 W, primary voltage 230 V, 50/60 Hz, secondary voltage 24 V, temperature range: stepless 150° C to 450° C. ANALOG 60 A complete antistatic according to MIL-SPEC/ESA standards.



8-210

8-210	Electronic temp.-controlled soldering station	ANA 60
8-211	Electronic temp.-controlled soldering station, antistatic	ANA 60 A
	Spare soldering tips, ERSADUR for ANALOG 60/60, 80/80 A	
8-212-1	Pencil point, extended, 0.4 mm Ø	832 UD
8-212-2	Pencil point, extended, 0.8 mm Ø	832 SD
8-212-3	Pencil point, 1.0 mm Ø	832 BD
8-212-4	Chisel-shaped, extended, 2.2 mm	832 KD
8-212-5	Chisel-shaped, 2.2 mm	832 CD
8-212-6	Chisel-shaped, 3.2 mm	832 ED
8-212-7	Chisel-shaped, 5.0 mm	832 VD

ERSA electronic temp.-controlled soldering station ANALOG 80 (80 W)

Temperature control by means of ERSERISTRONIC (thermo sensor located in the center of the soldering tip). Heating element with PTC-characteristics. A potential equalization jack ensures the respective safety of the components. Large selection of internally heated ERSADUR long-life tips, which are now non-turnable. The multifunctional holder with cleaning sponge can be used as a tip and tool holder. Technical data: rating: 80 W, primary voltage 230 V, 50/60 Hz, secondary voltage 24 V, temperature range: stepless 150° C to 450° C. ANALOG 80 A complete antistatic according to MIL-SPEC/ESA standards.



8-213

8-213	Electronic temp.-controlled soldering station	ANA 80
8-214	Electronic temp.-controlled soldering station, antistatic	ANA 80 A
	Spare soldering tips: see ANALOG 60	

SOLDERING STATIONS AND ACCESSORIES

DIG2000 - 80 W Power soldering station

DIG2000 is an intelligent, microprocessor controlled soldering station: flexible, multi-functional, antistatic - according to MIL-SPEC/ESA standards. Functions: set value adjustment, switch to select between °C and °F, selection of stand-by period between 0-60 min., offset and calibrating function, possibility to block any adjustments by a 3-digit pass word, „Energy-Function“ to adjust the station’s heating system. The soldering station includes 4 programs. Each program can be configured independently and differently with the above mentioned functions. Each soldering iron has its own program and when the tools are changed, the soldering station automatically switches to the corresponding program. The temperature is controlled by a digital PID algorithm, optimized for precise and quick temperature control.

- | | | |
|-------|--|-------------|
| 8-325 | Electronic station DIGITAL 2000 A, 80 W, antistatic
consisting of electronic station DIG 203 A
Soldering iron Power tool with tip 842 CD
Holder, antistatic, A 29 | DIG 20 A 84 |
| 8-330 | Electronic station DIGITAL 2000 A, 80 W, antistatic
consisting of electronic station DIG 203 A
compressor unit Cu 103 A
desoldering iron X-Tool 720 ENJ
holder A 36 | DIG 20 A XT |
| 8-320 | Electronic station, 230/24 V, 80 W, antistatic | DIG 203 A |

The electronic station DIG203 A can optionally be connected with the following soldering irons:

- | | | |
|-------|--|---|
| 8-321 | Soldering iron Tech tool, 24 V, 60 W,
with tip 612 AD, rating 70 W / 280° C -
60 W / 350° C, heat up rating 130 W,
heating time approx. 12 s (to 280° C), model:
antistatic according to MIL-SPEC/ESA standards

Spare soldering tips
8-323-1 Pencil point, 1.0 mm Ø
8-323-2 Chisel-shaped, 1.0 mm
8-323-3 Chisel-shaped, 1.6 mm | 640 ADJ

612 BD
612 CD
612 AD |
| 8-326 | Soldering iron Power tool, 24 V, with tip 842 CD
Rating 105 W / 280° C - 80 W / 350° C,
heat up rating 290 W, heating time approx. 40 s (to 280° C),
model: antistatic according to MIL-SPEC/ESA standards

Spare soldering tips
8-328-1 Pencil point, extended, 0.4 mm Ø
8-328-2 Pencil point, 1.0 mm Ø
8-328-3 Chisel-shaped, 2.2 mm
8-328-4 Chisel-shaped, 2.2 mm | 840 CDJ

842 UD
842 BD
842 KD
842 CD |
| 8-298 | SMD soldering iron Micro tool, 24 V, 20 W,
with tip 212 BD, rating 30 W / 280° C -
20 W / 350° C, heat up rating 65 W,
heating time approx. 50 s (to 280° C), model:
antistatic according to MIL-SPEC/ESA standards
spare soldering tip: see SMT UNIT 60 A | 270 BDJ |
| 8-299 | SMD desoldering pincette 40, 2 x 20 W,
with desoldering tips 422 ED, rating
2 x 30 W / 280° C - 2 x 20 W / 350° C,
heat up rating 130 W, heating time:
depending on tip , model:
antistatic according to MIL-SPEC/ESA standards
further desoldering tip pairs: see SMT UNIT 60 A | 430 EDJ |
| 8-332 | Desoldering tool X-Tool, 24 V, with tip
722 EN 1223, 2 heating elements each 60 W (to 350° C),
temperature control with Ni-CrNi thermo-element,
start vacuum: up to 800 mbar,
total length: approx. 70 mm, antistatic

Spare desoldering tips
8-334-1 Inner-Ø 0.8 mm, outside-Ø 2.3 mm
8-334-2 Inner-Ø 1.0 mm, outside-Ø 2.0 mm
8-334-3 Inner-Ø 1.2 mm, outside-Ø 2.3 mm
8-334-4 Inner-Ø 1.5 mm, outside-Ø 4.8 mm | 720 ENJ

722 EN 0823
722 EN 1020
722 EN 1223
722 EN 1548 |



8-325



8-330

Pic. without compressor unit



8-321



8-326



8-298



8-299



8-332

SOLDERING STATIONS AND ACCESSORIES, SMD-TOOLS



8-293

ERSA SMT UNIT 60 A electronic temperature-controlled antistatic SMD soldering and desoldering station

Ideal tool for SMD-soldering, -desoldering and -repair soldering. Temperature control by means of ERSa RESISTRONIC. Heating element with PTC-characteristics. Two independently adjustable tools, the SMD soldering iron Micro tool and the desoldering tweezers Pincette 40. Large selection of SMD soldering tips starting with 0.4 mm and desoldering tips from MELF's and MINI-MELF's, BQFP's and SOIC-housing to PLCC 84. A potential equalization jack ensures for the respective safety of the components. The revolutionary Micro Wave Technology enables soldering of a PQFP 208 in 60 seconds. Technical data: rating 60 W, primary voltage 230 V, 50/60Hz, secondary voltage 24 V, temperature range stepless (soldering iron 150° C to 400° C and desoldering tweezers depends on desoldering inserts). VDE/GS certificate. Complete antistatic according to MIL-SPEC/ESA standards.

8-293 **ERSA SMD-soldering and desoldering iron** SMT 60 A

Accessories for SMD-soldering and desoldering iron SMT UNIT 60 A

8-298 SMD-soldering iron Micro tool 270 BDJ

Spare soldering tips for Micro tool:

8-298-1 Pencil point, 0.4 mm Ø 212 BD*

8-298-2 Chisel-shaped, 1.0 mm 212 CD*

8-298-3 Chisel-shaped, 1.8 mm 212 ED*

8-298-4 Chisel-shaped, extended, 1.8 mm 212 KD*

8-298-10 Micro Wave 212 MS

8-299 SMD-desoldering pincette 40 430 EDJ

8-299-0 Holder for pincette 40 A 30

Desoldering tips (pair) for pincette 40:

8-299-1 6 mm for SOIC 8 422 ED*

8-299-2 10 mm for SOIC 16 422 FD 1*

8-299-3 15 mm for SOIC 24 422 FD 2*

8-299-4 90°angle, length 12.5 mm for PLCC 28 422 QD 1*

8-299-5 90°angle, length 17.5 mm for PLCC 44 422 QD 3*

8-299-6 90°angle, length 20 mm for PLCC 52 422 QD 4*

8-299-7 90°angle, length 25 mm for PLCC 68 422 QD 2*

8-299-8 90°angle, length 10 mm for PLCC 20 422 QD 5

8-299-9 Ellipse for MELF and MINIMELF 422 MD*

8-299-10 7.5 mm für SOIC 12 422 FD 3

8-299-11 12.5 mm for SOIC 20 422 FD 4

8-299-12 17.5 mm for SOIC 28 422 FD 5

8-299-13 20 mm for SOIC 32 422 FD 6



8-297-0

ERSA tip holder for SMT UNIT 60 A, completely equipped SMD 8012

Tip holder, completely equipped with 4 soldering tips (0.4-1.8 mm); 8 desoldering tips (pairs) for PLCC 28, 44, 52 and 68; SOIC 8, 16, 24 and MELF's and MINIMELF's (detailed list of tips see *at SMT UNIT 60 A).

8-297 **Tip holder, not equipped** SH 03

8-297-0 **Tip holder, completely equipped** SMD 8012

ERSA SMD-Vacuumpipette SMD-Vampir SVP 100

Vacuumpipette for easy, safety and precise handling of SMD components. Various antistatic vacuum cups (4, 7 and 9 mm) and the bent vacuum nozzle made from high-grade steel enable a large field of application.

8-238 **ERSA SMD-Vampir 100** SVP 100



8-238

BERNSTEIN Vacuum pump SMD VAC

This vacuum pump is distinguished by its low-noise and low-vibration running and is maintenance-free with a long service-life. The pump offers optimum conditions for manual application of SMD components. The vacuum pipette has a finger hole lower down which can be closed with the index finger in order to pick up the component. Technical data: output 5.0 l/min, vacuum 160 mbar, operating pressure 0.4 bar, power supply 220 V / 50 Hz, input 0.5 Amp., dimensions 210 x 150 x 100 mm.

9-550 **Vakuumpumpe SMD VAC**
with suction hose, pipette, 4 different suction needles

Spare suction needles

9-550-14 Suction needle, 1.60 mm Ø

9-550-15 Suction needle, 1.37 mm Ø

9-550-18 Suction needle, 0.84 mm Ø

9-550-21 Suction needle, 0.51 mm Ø



9-550

DESOLDERING PUMPS

- 8-380 **Universal desoldering tool Soldapullt US 340**
Antistatic desoldering tool for safe desoldering of voltage sensitive MOS-LSI semiconductors. Self cleaning static conductive teflon tip, adjustable shaft.
8-381 Metalized teflon bit LS 197
- 8-382 **Desoldering tool Soldapullt Successor SS 011**
Antistatic, handy desoldering tool with low static potential. The metal cylinder and the high ohmic conductive teflon bit protect against electrostatic discharge - two loading and releasing possibilities. Easily and quickly disassembled for cleaning and maintenance, removable releasing lever.
8-381 Metalized teflon bit LS 197
- 8-385 **ERSA desoldering tool VAC 3**
antistatic, 10 cm³ suction volume
8-386 Spare desoldering tip VAC 32
- 8-387 **ERSA desoldering tool VAC 5**
antistatic, 14.5 cm³ suction volume
8-388 Spare desoldering tip VAC 52

Desoldering suction pumps PRAKTIK

Handy tools in an all-metal cabinet with interchangeable teflon bit, high suction capacity by dual-sealing of the bulb.
Colour: gold

- 8-390 **Desoldering pump**
195 mm long, 20 mm Ø
8-391 Spare teflon bit



8-380



8-382



8-385



8-387

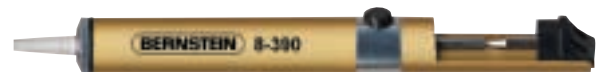

8-390

SOLDERING EQUIPMENT

- 8-421 **ERSA solder wire dispenser (without wire)** SR 100
practical, stable solder wire dispenser for various solder wire-Ø and -spools (250/500/1000 g). A centering nut ensures that the reels of solder wire are centered correctly. The optional ERSA SR 101 add-on is easily mounted for a second solder wire reel.
- 8-422 **Kit for SR 100** SR 101
(without wire)



8-421 + 8-422

Solder wire Sn60Pb38Cu2, to DIN 1707 with 2.2% soldering flux F-SW 26, to DIN 8511

- 8-401 Solder wire (roll), approx. 1 m, 1.0 mm Ø
8-402 Solder wire (spool), 100 g, 1.0 mm Ø
8-403 Solder wire (spool), 250 g, 1.0 mm Ø
8-405 Solder wire (spool), 1000 g, 1.0 mm Ø
8-406 Solder wire (spool), 250 g, 0.6 mm Ø
8-407 Solder wire (spool), 250 g, 0.8 mm Ø



Desoldering braid in plastic spool

for quick and neat desoldering in laboratories and workshops

- 8-412 Desoldering braid, width approx. 0.8 mm, 1.70 m spool
8-413 Desoldering braid, width approx. 1.5 mm, 1.50 m spool
8-414 Desoldering braid, width approx. 2.2 mm, 1.50 m spool
8-415 Desoldering braid, width approx. 2.7 mm, 1.50 m spool
- 8-465 **No-Clean soldering flux**, F-SW 32, DIN 8511, colophony based, low activated, 15 g in 5 ml cartridge for dispenser (3 bar) and manual use.
- 8-471 **Dosing needles (5 pieces)**, from plastic suitable for cartridge No. 8-465





BERNSTEIN

HIGH TECH Tools

BERNSTEIN

Electronic-Tools

BERNSTEIN-Werkzeugfabrik Steinrücke GmbH

D-42861 REMSCHEID · P.O. BOX 11 01 44 · ☎ (0 21 91) 96 50 - 0 · FAX (0 21 91) 96 50 30 or 66 61 59

Internet: <http://www.bernstein-werkzeuge.de> · email: info@bernstein-werkzeuge.de

Catalogue 011