



Air moving solutions made simple



AC Fans
DC Fans



AC Blowers
DC Blowers



AC Impellers
DC Impellers



AC Motors



Accessories

Search

- Part/Model #
- Stock Check
- Cross-Reference
- Keyword

More Products

- Heat Sinks
- Fan Accessories
- Engineering Tools
- Airflow Calculator
- Thermal Calculator
- Unit Conversions
- Application Notes
- Custom Solutions
- Company Info
- Contact Info
- Technical Capability
- Certifications
- Terms & Conditions
- Employment Ops

Gateway Online

Phone: 858.348.6200 FAX: 858.566.4577

Distributors

Find a Rep

Contact Us

Muffin XL - MD12B1-E2 - 031440 - No
 (Family) (Model) (Part #) (In Stock)

Electrical Specifications

Operating Voltage:	12 Volts
Voltage Range:	6 - 14 Volts
Power Supply:	6.0 Watts
Line Current:	0.50 Amps
Locked Rotor Current	1.65 Amps
Nominal Speed:	3330 RPM

Mechanical Specifications

Dimensions:	4.7 x 4.7 x 1.5 in
Weight	21.5 oz
Max Airflow @ 0 in H₂O	110.0 CFM
Max Pressure @ 0 CFM	0.278 in H ₂ O
Noise	50.0 dBA



Detailed Drawing Printer-Friendly Datasheet

Mechanical Drawing

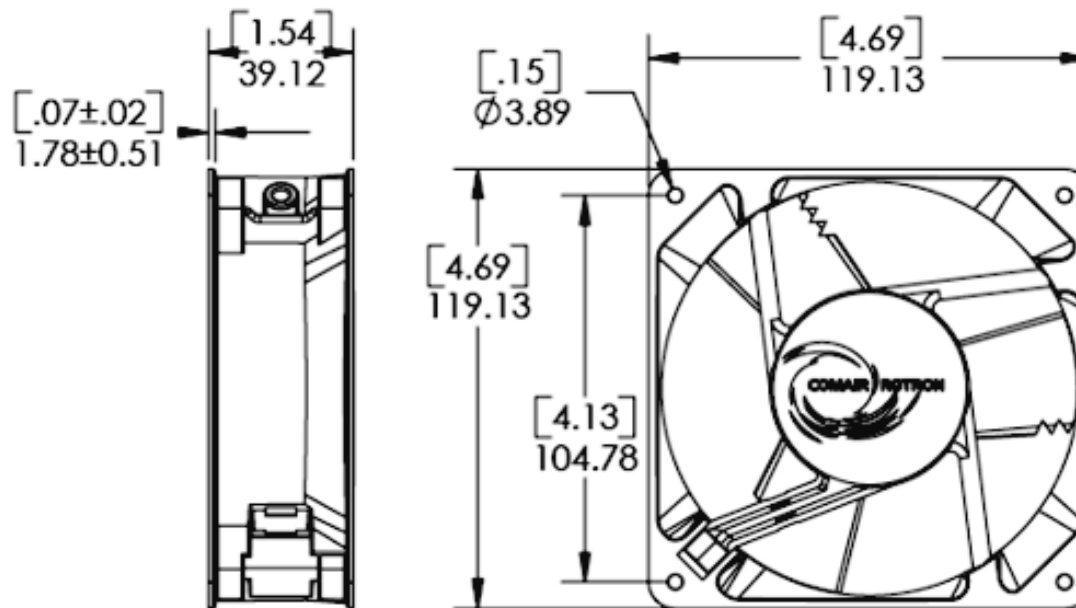

Fan Performance Curve

Fan Configuration Options

Muffin XL (Family)	-	MD12B1-E2 (Model)	-	031440 (Part #)	-	No (In Stock)
Fan Speed Options		Fan Bearing Options		Fan Airflow Direction Options		Fan Termination Options
Full Speed (3330 RPM)		Ball Bearings		Flow L (CW Rotation)		Leads
7/8 Speed (2780 RPM)		Sleeve Bearings		Flow R (CCW Rotation)		Terminals

Fan Monitoring Options

No Fan Monitoring Options Required

Add Tachometer (1 pulses per revolution.)

Add Fan Performance Sensor (FPS)

Fan Speed Control Options

Add ThermaPro-V Fan Speed Control

Environmental Protection Options

Add Enviroshield Environmental Protection

Accessories (Click on part number for detailed drawing.)

571064
Plug and Cord



550113
Mounting Clip

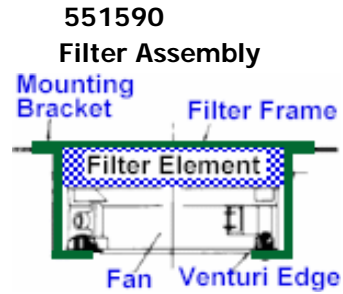
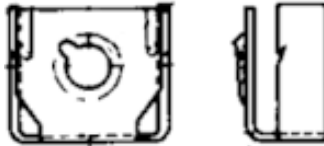

554148
Filter Guard Assembly

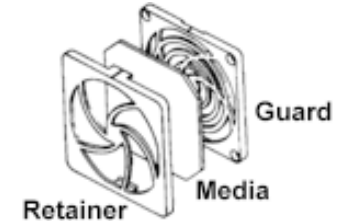

552934
Finger Guard



476042
Finger Guard

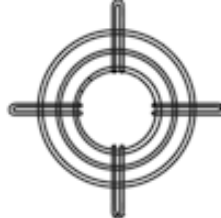

550481
Finger Guard

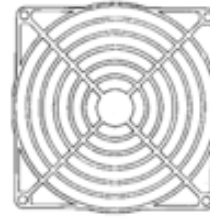

551147
Finger Guard

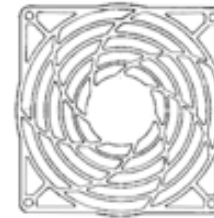

Comair Rotron, Inc.
Phone: 858.348.6200
FAX: 858.566.4577
sales@comairrotron.com

ThermaFlo, Inc.
Phone: 972.312.8609
FAX: 972.312.8617
info@thermaflo.com

Comair Rotron Europe, Ltd.
Phone: +44.1527.520525
FAX: +44.1527.520565
saleseurope@comairrotron.com

Comair Rotron Fan Company Ltd.
Phone: +86.21.52260581
FAX: +86.21.52260597
salesasia@comairrotron.com