

**SERIES:** PSK-10W | **DESCRIPTION:** INTERNAL AC-DC POWER SUPPLY

**FEATURES**

- wide input range (85~305 Vac)
- UL/EN/IEC 62368 certified
- meets CISPR32/EN 55032 Class B without external components
- short-circuit, over-current, over-voltage protections



MODEL	output voltage	output current	output power	ripple and noise	efficiency
	(Vdc)	max (A)	max (W)	typ (mVp-p)	typ (%)
PSK-10W-3	3.3	2.0	6.6	100	72
PSK-10W-5	5	2.0	10	100	76
PSK-10W-9	9	1.1	10	100	79
PSK-10W-12	12	0.9	10.8	100	81
PSK-10W-15	15	0.7	10.5	100	81
PSK-10W-24	24	0.45	10.8	100	82

**PART NUMBER KEY**

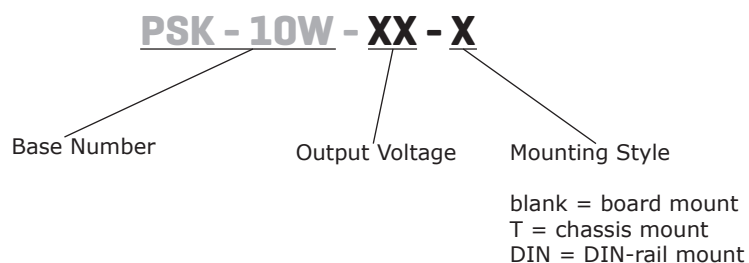

**INPUT**

parameter	conditions/description	min	typ	max	units
voltage	ac input	85		305	Vac
	dc input	100		430	Vdc
frequency		47		63	Hz
current	at 115 Vac			.23	A
	at 230 Vac			.15	A
inrush current	at 115 Vac		15		A
	at 230 Vac		30		
leakage current	230 Vac / 50 Hz			.25	mA
no load power consumption	at 230 Vac			0.5	W

**OUTPUT**

parameter	conditions/description	min	typ	max	units
capacitive load	3.3 Vdc output models			26400	μF
	5 Vdc output models			9440	
	9 Vdc output models			3600	
	12 Vdc output models			2000	
	15 Vdc output models			1170	
	24 Vdc output models			370	
output voltage accuracy	3.3 V		±3		%
	all other models		±2		%
line regulation	full load		±0.5		%
load regulation	0~100% load		±1.0		%
hold-up time	at 115 Vac		8		ms
	at 230 Vac		75		ms
switching frequency			100		kHz
temperature coefficient			±0.02		%/°C

**PROTECTIONS**

parameter	conditions/description	min	typ	max	units
over voltage protection	3.3 / 5 Vdc output models			9	V
	9 Vdc output models			15	
	12 Vdc output models			20	
	15 Vdc output models			25	
	24 Vdc output models			35	
over current protection	self recovery	110		300	%
short circuit protection	hiccup, continuous, self recovery				

## SAFETY & COMPLIANCE

parameter	conditions/description	min	typ	max	units
isolation voltage	input to output	4,000			Vac
safety approvals	IEC 62368/EN 62368/UL 62368				
safety class	Class II				
EMI/EMC	CISPR 32/EN 55032: 2015 Class B				
ESD	IEC/EN 61000-4-2: Contact ±6KV/ Air ±8KV, perf. Criteria B				
radiated immunity	IEC/EN 61000-4-3: 10V/m, perf. Criteria A				
EFT/burst	IEC/EN 61000-4-4: ±2KV, perf. Criteria B IEC/EN 61000-4-4: ±4KV, see recommended circuit, perf. Criteria B				
surge	IEC/EN 61000-4-5: line to line ±1KV, perf. Criteria B IEC/EN 61000-4-5: line to line ±2KV, line to ground ±4KV, see recommended circuit				
conducted immunity	IEC/EN 61000-4-6: 10Vr.m.s, perf. Criteria A				
voltage dips	IEC/EN 61000-4-11: 0%, 70%				
MTBF	as per MIL-HDBK-217F @ 25°C	300,000			hours
RoHS	yes				

## DERATING CURVE

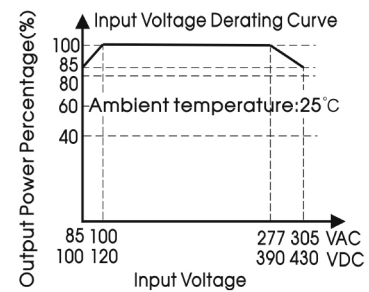
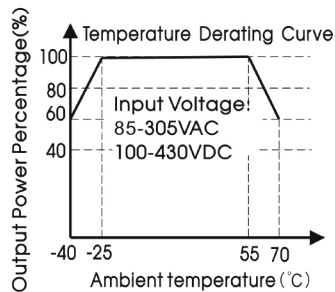

## EFFICIENCY CURVES

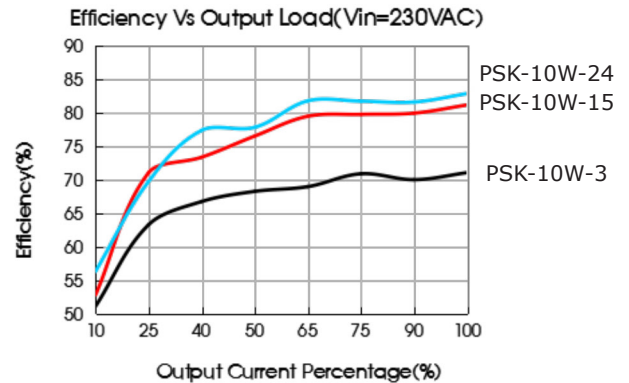
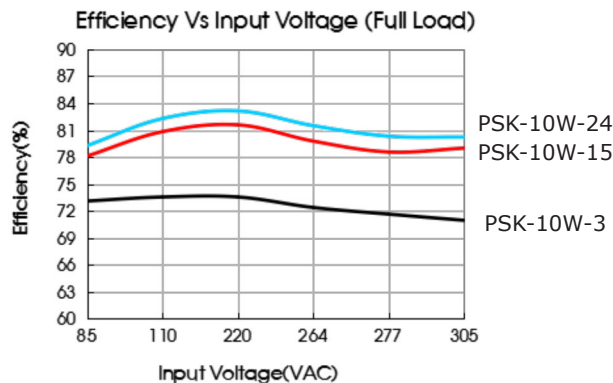

## ENVIRONMENTAL

parameter	conditions/description	min	typ	max	units
operating temperature	see derating curves	-40		70	°C
storage temperature		-40		85	°C
storage humidity	non-condensing	0		95	%

## SOLDERABILITY

parameter	conditions/description	min	typ	max	units
wave soldering	for 5~10 seconds	255	260	265	°C
hand soldering	for 3~5 seconds	350	360	370	°C

## MECHANICAL

parameter	conditions/description	min	typ	max	units
dimensions	53.80 x 28.80 x 19.00				mm
weight			48		g
cooling	free air convection				
case material	Black plastic, flame-retardant and heat-resistant (UL94V-0)				

## MECHANICAL DRAWING (BOARD MOUNT)

units: mm [inch]  
 tolerance: ±0.50 [±0.020]  
 pin diameter tolerances: ±0.10 [±0.004]

PIN CONNECTIONS	
PIN	Function
1	AC (N)
2	AC (L)
3	-Vo
4	+Vo

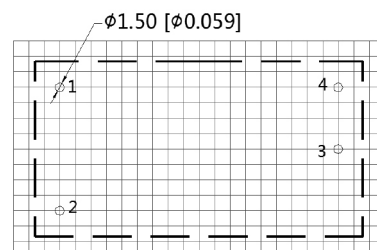

Note : Grid 2.54\*2.54mm

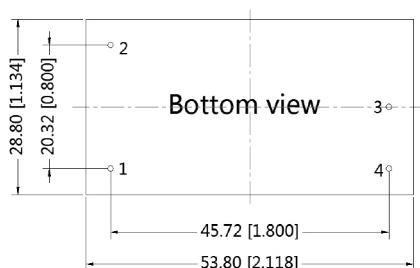

## MECHANICAL DRAWING [CHASSIS MOUNT]

units: mm [inch]  
 tolerance:  $\pm 0.50$  [ $\pm 0.020$ ]  
 wire range: 24~12 AWG  
 tightening torque: max 0.4 N·m

PIN CONNECTIONS	
PIN	Function
1	AC (N)
2	AC (L)
3	-Vo
4	+Vo

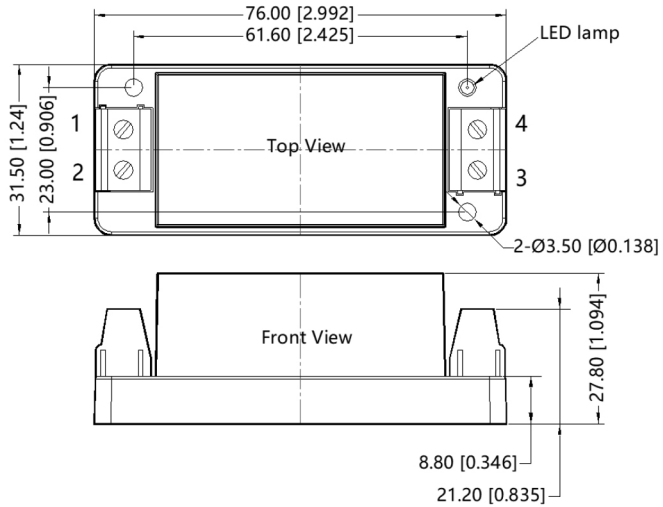

## MECHANICAL DRAWING [DIN-RAIL MOUNT]

units: mm [inch]  
 tolerance:  $\pm 1.00$  [ $\pm 0.039$ ]  
 wire range: 24~12 AWG  
 tightening torque: max 0.4 N·m

PIN CONNECTIONS	
PIN	Function
1	AC (N)
2	AC (L)
3	-Vo
4	+Vo

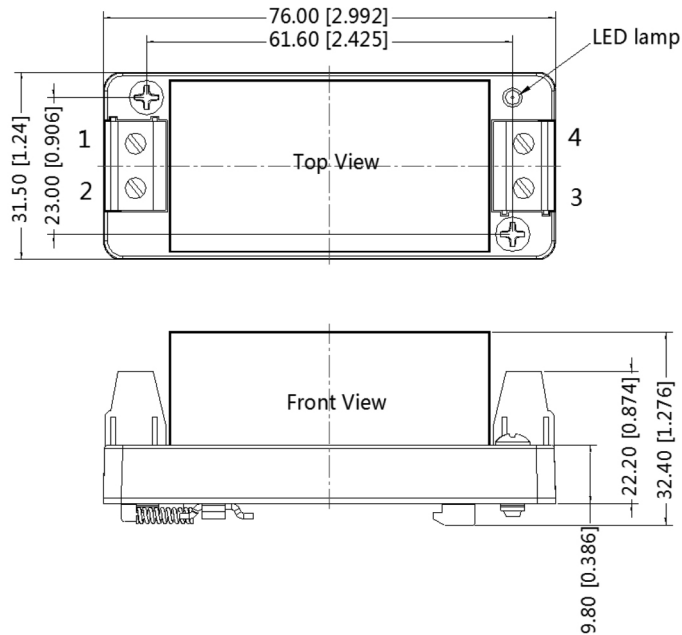

## TYPICAL APPLICATION CIRCUIT

Figure 1

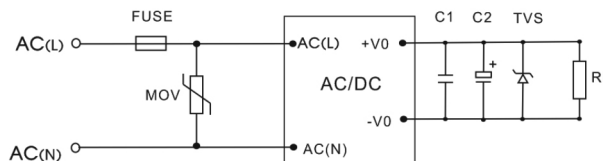

Table 1

Recommended External Circuit Components					
Vo (Vdc)	FUSE <sup>6</sup>	MOV <sup>6</sup>	C1	C2	TVS
3.3	2A/300V	S14K350	1μF/50V	470μF/10V	SMBJ7.0A
5	2A/300V	S14K350	1μF/50V	470μF/10V	SMBJ7.0A
9	2A/300V	S14K350	1μF/50V	220μF/25V	SMBJ15A
12	2A/300V	S14K350	1μF/50V	220μF/25V	SMBJ20A
15	2A/300V	S14K350	1μF/50V	220μF/25V	SMBJ20A
24	2A/300V	S14K350	1μF/50V	100μF/35V	SMBJ30A

Notes: 6. Chassis Mount and DIN-Rail Mount versions include the fuse and MOV components.

## EMC RECOMMENDED CIRCUIT

Figure 2

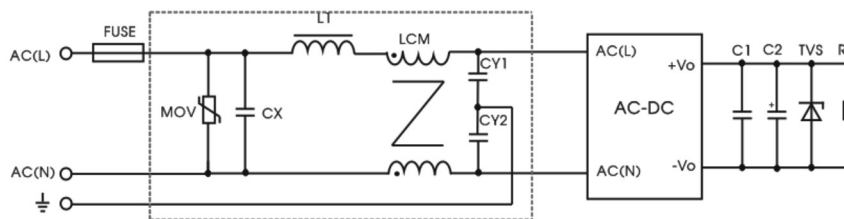

Table 2

Recommended External Circuit Components	
FUSE	3.15 A/300 V, slow fusing
MOV	S14K350
LCM	2.2 mH
CX	0.1 μF/310 Vac
L1	4.7 μH/ 2 A
CY1/CY2	1000 pF/400 Vac

Note: Also refer to Table 1.

Notes: 7. C1 is a ceramic capacitor used to filter high frequency noise.  
 8. C2 is an electrolytic capacitor and it is recommended to be high frequency and low impedance. For capacitance and current of capacitor, refer to the datasheet provided by the manufacturer. Voltage derating of capacitor should be at least 80%.  
 9. TVS is a recommended component to protect post-circuits (if converter fails).

## REVISION HISTORY

---

rev.	description	date
1.0	initial release	06/29/2020

The revision history provided is for informational purposes only and is believed to be accurate.



**Headquarters**  
20050 SW 112th Ave.  
Tualatin, OR 97062  
**800.275.4899**

Fax 503.612.2383  
**cui.com**  
techsupport@cui.com

CUI offers a two (2) year limited warranty. Complete warranty information is listed on our website.

CUI reserves the right to make changes to the product at any time without notice. Information provided by CUI is believed to be accurate and reliable. However, no responsibility is assumed by CUI for its use, nor for any infringements of patents or other rights of third parties which may result from its use.

CUI products are not authorized or warranted for use as critical components in equipment that requires an extremely high level of reliability. A critical component is any component of a life support device or system whose failure to perform can be reasonably expected to cause the failure of the life support device or system, or to affect its safety or effectiveness.