

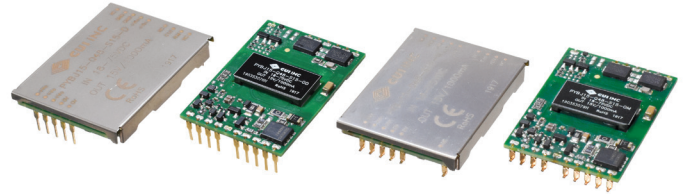

**SERIES:** PYBJ15 | **DESCRIPTION:** DC-DC CONVERTER

**FEATURES**

- up to 15 W isolated output
- ultra wide 4:1 input voltage range
- single regulated output
- output short circuit, over current, over voltage protection
- efficiency up to 89%
- DIP and SMT mounting styles
- available with or without case
- 1500 Vdc isolation



MODEL	input voltage		output voltage (Vdc)	output current		output power max (W)	ripple & noise <sup>1</sup> max (mVp-p)	efficiency <sup>2</sup> typ (%)
	typ (Vdc)	range (Vdc)		min (mA)	max (mA)			
PYBJ15-Q24-S3	24	9~36	3.3	0	4500	14.85	100	88
PYBJ15-Q24-S5	24	9~36	5	0	3000	15	100	88
PYBJ15-Q24-S12	24	9~36	12	0	1250	15	100	89
PYBJ15-Q24-S15	24	9~36	15	0	1000	15	100	89
PYBJ15-Q48-S3	48	18~75	3.3	0	4500	14.85	100	88
PYBJ15-Q48-S5	48	18~75	5	0	3000	15	100	88
PYBJ15-Q48-S12	48	18~75	12	0	1250	15	100	89
PYBJ15-Q48-S15	48	18~75	15	0	1000	15	100	89

Notes: 1. From 5~100% load, nominal input, 20 MHz bandwidth oscilloscope, with 10 µF tantalum and 1 µF ceramic capacitors on the output. From 0~5% load, ripple and noise is <5% Vo.  
 2. Measured at nominal input voltage, full load.  
 3. All specifications are measured at Ta=25°C, humidity < 75%, nominal input voltage, and rated output load unless otherwise specified.

**PART NUMBER KEY**

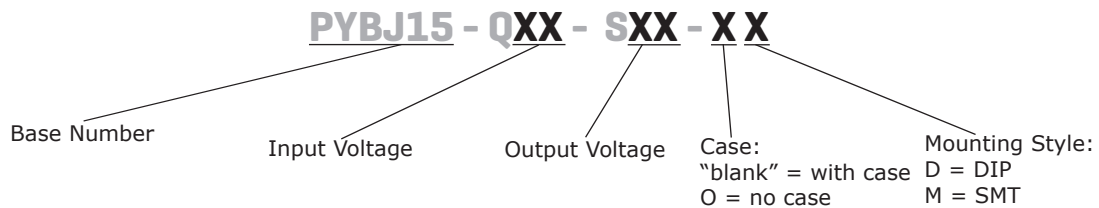

**INPUT**

parameter	conditions/description	min	typ	max	units
operating input voltage	24 Vdc input models	9	24	36	Vdc
	48 Vdc input models	18	48	75	Vdc
start-up voltage	24 Vdc input models			9	Vdc
	48 Vdc input models			18	Vdc
surge voltage	24 Vdc input models for 1 second max	-0.7		50	Vdc
	48 Vdc input models for 1 second max	-0.7		100	Vdc
under voltage shutdown	24 Vdc input models	5.5	6.5		Vdc
	48 Vdc input models	12	15.5		Vdc
current	24 Vdc input models	3, 5 Vdc output models 12, 15 Vdc output models		727 718	mA mA
	48 Vdc input models	3.3 Vdc output models 5 Vdc output models		363 360	mA mA
start-up current	24 Vdc input models			3,000	mA
	48 Vdc input models			1,500	mA
remote on/off (CTRL) <sup>4</sup>	turn on (CTRL pin pulled low to GND (0~1.2 Vdc)) turn off (CTRL pin open or pulled high (3.5~12 Vdc)) input current when switched off		6	15	mA
alarm indication (ALM)	Valm (relative to GND), when under voltage protection is going to happen, and during the over voltage protection working status.		0.2	1.2	Vdc
	Valm (relative to GND), other working status	3.5	9		Vdc
filter	Pi filter				
no load power consumption			0.36		W

Notes: 4. The voltage of the CTRL pin is referenced to input GND pin.

**OUTPUT**

parameter	conditions/description	min	typ	max	units
maximum capacitive load <sup>5</sup>	3.3, 5 Vdc output models			4,700	μF
	12 Vdc output models			1,000	μF
	15 Vdc output models			820	μF
voltage accuracy	from 0% to full load		±1	±2	%
line regulation	from low line to high line, full load		±0.2	±0.5	%
load regulation <sup>6</sup>	from 5% to full load		±0.5	±1	%
switching frequency <sup>7</sup>	PWM mode		300		kHz
transient recovery time	25% load step change, nominal input voltage		300	500	μs
transient response deviation	25% load step change, nominal input voltage				
	3.3, 5 Vdc output models all other output models		±3 ±3	±8 ±5	% %
temperature coefficient	at full load			±0.03	%/°C

Note: 5. Tested at input voltage range and full load.

6. At 0~100% load, the max load regulation is ±3%.

7. Value is based on full load. At loads &lt;50%, the switching frequency decreases with decreasing load for efficiency improvement.

## PROTECTIONS

parameter	conditions/description	min	typ	max	units
over voltage protection	output shut down	110		160	%
over current protection	hiccup, auto recovery	110	180	230	%
short circuit protection	hiccup, continuous, auto recovery				

## SAFETY AND COMPLIANCE

parameter	conditions/description	min	typ	max	units
isolation voltage	input to output for 1 minute at 1 mA	1,500			Vdc
	input to case <sup>8</sup> for 1 minute at 1 mA	500			Vdc
	output to case <sup>8</sup> for 1 minute at 1 mA	500			Vdc
isolation resistance	input to output at 500 Vdc	100			MΩ
	input to case <sup>8</sup> at 500 Vdc	100			MΩ
	output to case <sup>8</sup> at 500 Vdc	100			MΩ
isolation capacitance	input to output, 100 kHz / 0.1 V		1,000		pF
safety approvals	IEC 62368-1, EN 62368-1				
conducted emissions	CISPR32/EN55032, class B (external circuit required, see Figure 2-a)				
radiated emissions	CISPR32/EN55032, class B (external circuit required, see Figure 2-a)				
ESD	IEC/EN61000-4-2, contact ±6 kV, class B				
radiated immunity	IEC/EN61000-4-3, 10 V/m, class A				
EFT/burst	IEC/EN61000-4-4, ±2 kV, class B (external circuit required, see Figure 2-b)				
surge	IEC/EN61000-4-5, line-line ±2 kV, class B (external circuit required, see Figure Figure 2-b)				
conducted immunity	IEC/EN61000-4-6, 3 Vr.m.s, class A				
MTBF	as per MIL-HDBK-217F, 25°C	1,000,000			hours
RoHS	yes				

Note: 8. Only applies to versions with case.

## ENVIRONMENTAL

parameter	conditions/description	min	typ	max	units
operating temperature	see derating curves	-40		85	°C
storage temperature		-55		125	°C
storage humidity	non-condensing	5		95	%
vibration	10~150 Hz, for 60 minutes on each axis		5		G

## DERATING CURVES

Temperature Derating Curve  
(Output Load vs. Ambient Temperature  
3.3, 5 Vdc output models)

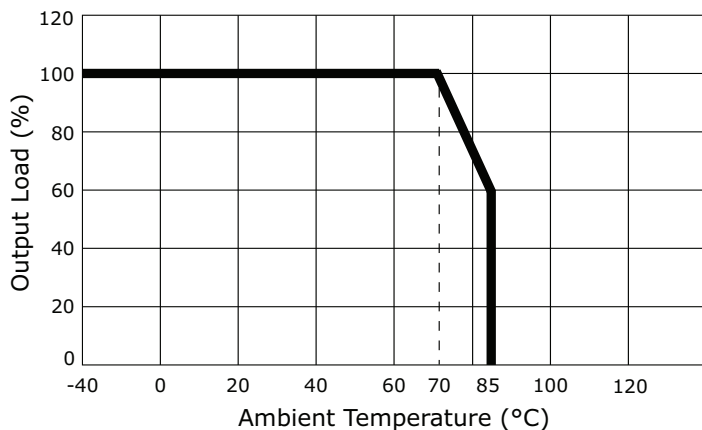

Temperature Derating Curve  
(Output Load vs. Ambient Temperature  
12, 15 Vdc output models)

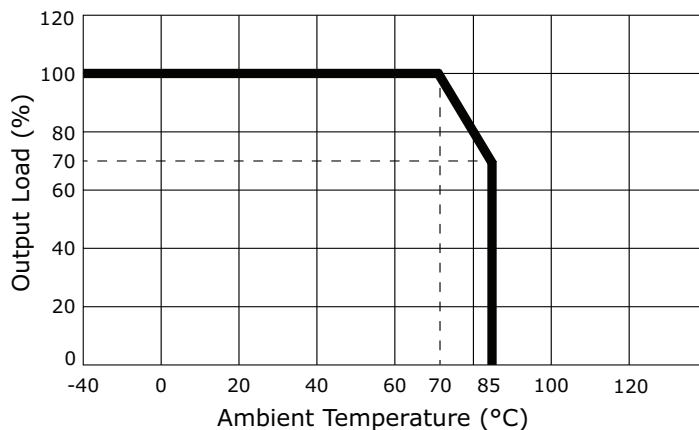

## SOLDERABILITY

parameter	conditions/description	min	typ	max	units
hand soldering	1.5 mm from case for 10 seconds			300	°C
wave soldering <sup>9</sup>	see wave soldering profile			260	°C
reflow soldering <sup>10</sup>	see reflow soldering profile Maximum duration >217°C is 60 seconds. For actual application, refer to IPC/JEDEC J-STD-020D.1			245	°C

Note: 9. For DIP models only.  
10. For SMT models only.

Wave Soldering Profile  
(DIP models)

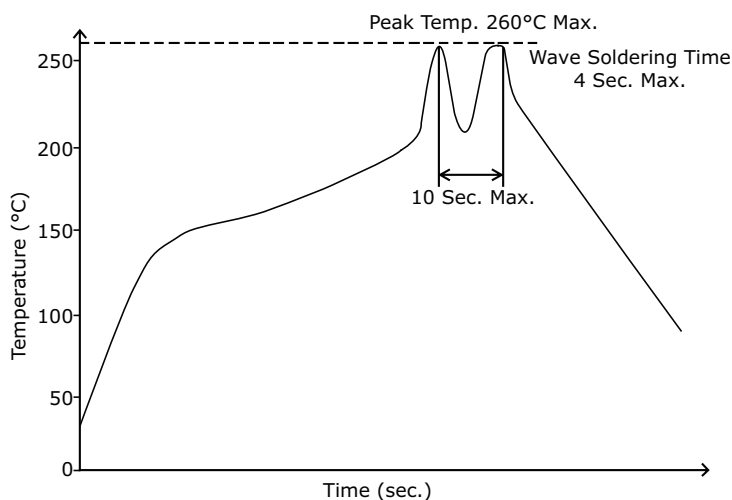

Reflow Soldering Profile  
(SMT models)

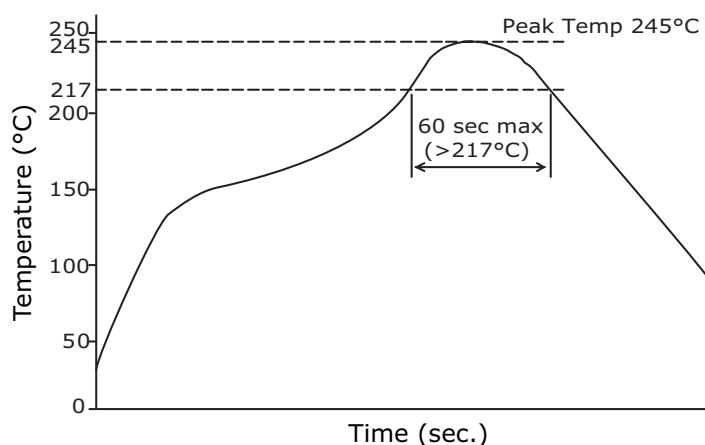

## MECHANICAL

parameter	conditions/description	min	typ	max	units
dimensions	DIP without case: 3.3, 5 Vdc output models: 38.70 x 27.20 x 6.20 [1.524 x 1.071 x 0.244 inch] 12, 15 Vdc output models: 38.70 x 27.20 x 5.80 [1.524 x 1.071 x 0.228 inch]				mm mm
	DIP with case: 3.3, 5 Vdc output models: 39.10 x 29.50 x 6.80 [1.539 x 1.161 x 0.268 inch] 12, 15 Vdc output models: 39.10 x 29.50 x 6.40 [1.539 x 1.161 x 0.252 inch]				mm mm
	SMT without case: 3.3, 5 Vdc output models: 38.70 x 27.20 x 6.20 [1.524 x 1.071 x 0.244 inch] 12, 15 Vdc output models: 38.70 x 27.20 x 5.80 [1.524 x 1.071 x 0.228 inch]				mm mm
	SMT with case: 3.3, 5 Vdc output models: 39.10 x 29.50 x 6.80 [1.539 x 1.161 x 0.268 inch] 12, 15 Vdc output models: 39.10 x 29.50 x 6.40 [1.539 x 1.161 x 0.252 inch]				mm mm
case material	aluminum alloy				
weight	without case 3.3, 5 Vdc output models		11.0		g
	without case 12, 15 Vdc output models		8.8		g
	with case 3.3, 5 Vdc output models		13.8		g
	with case 12, 15 Vdc output models		11.5		g

## MECHANICAL DRAWING (DIP WITHOUT CASE)

units: mm [inch]  
 tolerance:  $\pm 0.50[\pm 0.020]$   
 pin section tolerance:  $\pm 0.10[\pm 0.004]$

PIN CONNECTIONS	
PIN	Function
1	+Vo
2	+Vo
3	+Vo
4	0V
5	0V
6	NC
7	ALM
8	CTRL
9	NC
10	+Vin
11	+Vin
12	GND
13	GND
14	NC

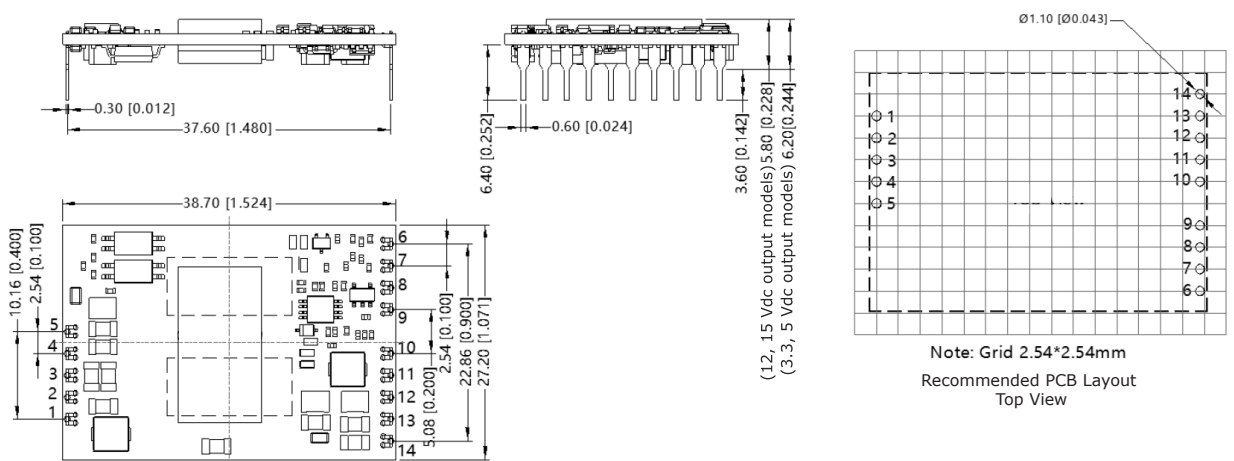

Note: NC = no connect

## MECHANICAL DRAWING (DIP WITH CASE)

units: mm [inch]  
 tolerance:  $\pm 0.50[\pm 0.020]$   
 pin section tolerance:  $\pm 0.10[\pm 0.004]$

PIN CONNECTIONS	
PIN	Function
1	+Vo
2	+Vo
3	+Vo
4	0V
5	0V
6	NC
7	ALM
8	CTRL
9	NC
10	+Vin
11	+Vin
12	GND
13	GND
14	NC

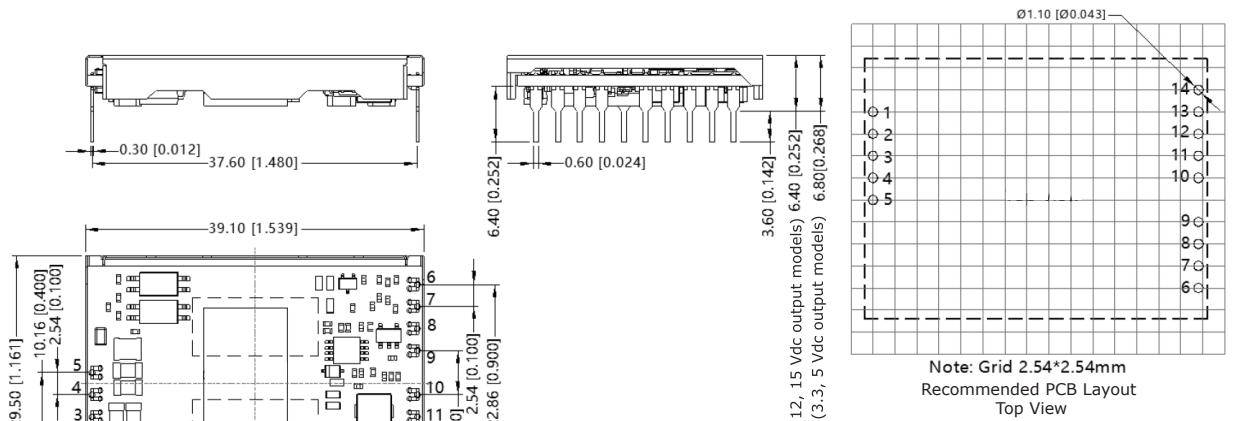

Note: NC = no connect

## MECHANICAL DRAWING (SMT WITHOUT CASE)

units: mm [inch]  
 tolerance:  $\pm 0.50[\pm 0.020]$   
 pin section tolerance:  $\pm 0.10[\pm 0.004]$

PIN CONNECTIONS	
PIN	Function
1	+Vo
2	+Vo
3	+Vo
4	0V
5	0V
6	NC
7	NC
8	ALM
9	CTRL
10	NC
11	+Vin
12	+Vin
13	GND
14	GND
15	NC

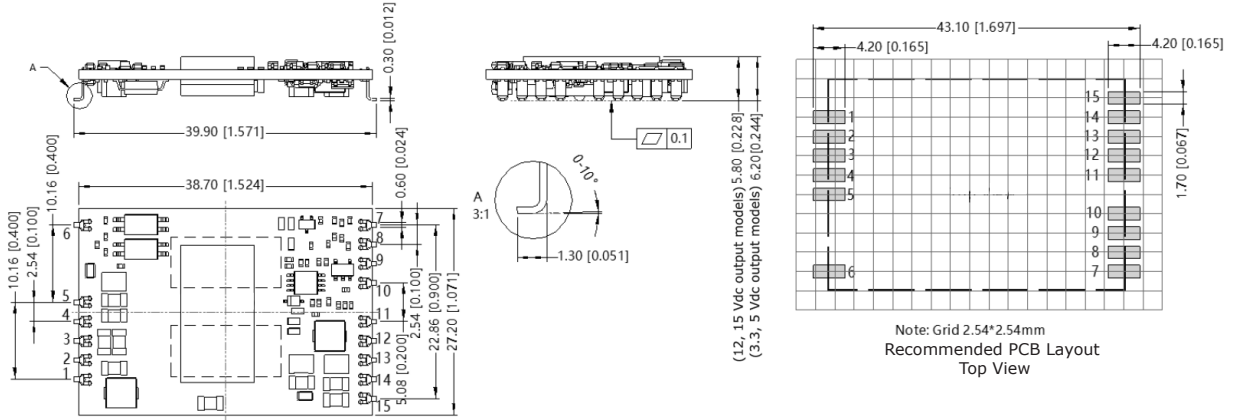

Note: Grid 2.54\*2.54mm  
 Recommended PCB Layout  
 Top View

Note: NC = no connect

## MECHANICAL DRAWING (SMT WITH CASE)

units: mm [inch]  
 tolerance:  $\pm 0.50[\pm 0.020]$   
 pin section tolerance:  $\pm 0.10[\pm 0.004]$

PIN CONNECTIONS	
PIN	Function
1	+Vo
2	+Vo
3	+Vo
4	0V
5	0V
6	NC
7	NC
8	ALM
9	CTRL
10	NC
11	+Vin
12	+Vin
13	GND
14	GND
15	NC

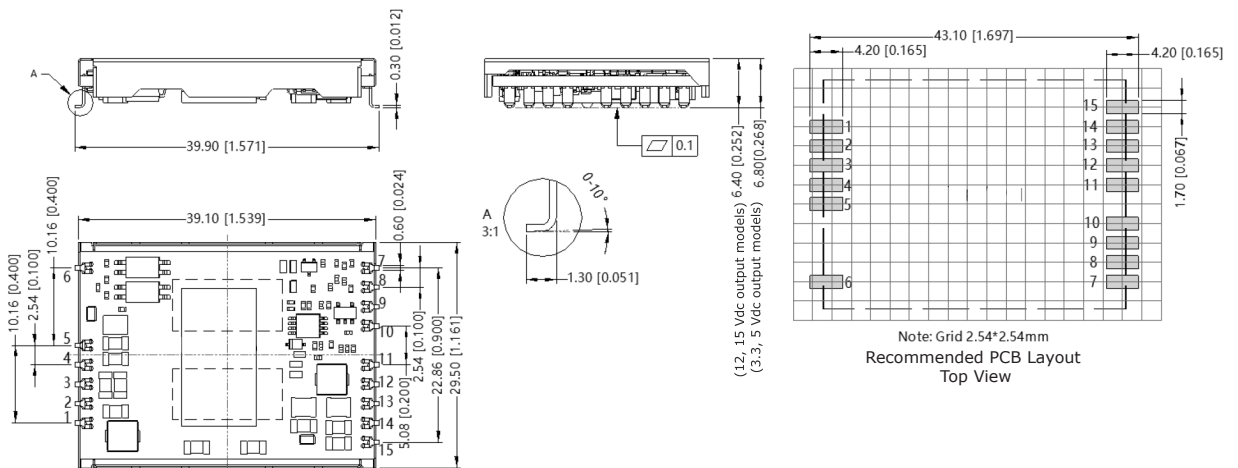

Note: Grid 2.54\*2.54mm  
 Recommended PCB Layout  
 Top View

Note: NC = no connect

## APPLICATION CIRCUIT

This series has been tested according to the following recommended circuit (Figure 1) before leaving the factory. If you want to further reduce the input and output ripple, you can increase the input and output capacitors or select capacitors of low equivalent impedance provided that the capacitance is less than the maximum capacitive load of the model.

Figure 1



Table 1

Vout (Vdc)	Cin ( $\mu$ F)	Cout ( $\mu$ F)
3.3/5/12/15	100	10

## EMC RECOMMENDED CIRCUIT

Figure 2

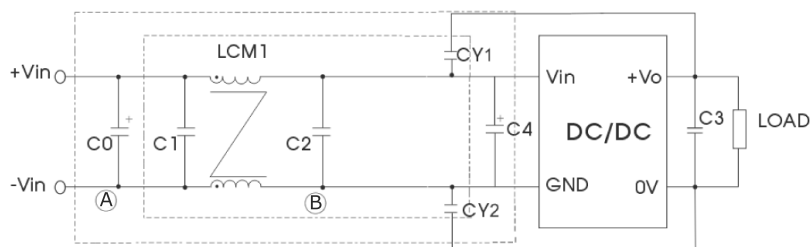

Table 2

Recommended External Circuit Components		
Vin (Vdc)	24	48
FUSE	choose according to actual input current	
C0	470 $\mu$ F / 50 V	680 $\mu$ F / 100 V
C1, C2	4.7 $\mu$ F / 50 V	4.7 $\mu$ F / 100 V
C3	refer to the Cout in Table 1	
C4	330 $\mu$ F / 50 V	330 $\mu$ F / 100 V
LCM1	4.7 $\mu$ H	
CY1, CY2	2000 pF / 2 kV	

## PACKAGING

units: mm

Inner Carton Size: 280 x 196 x 63 mm  
 Outer Carton Size: 600 x 285 x 225 mm  
 Outer Carton QTY: 288 pcs

9 PCS of products in one plastic tray

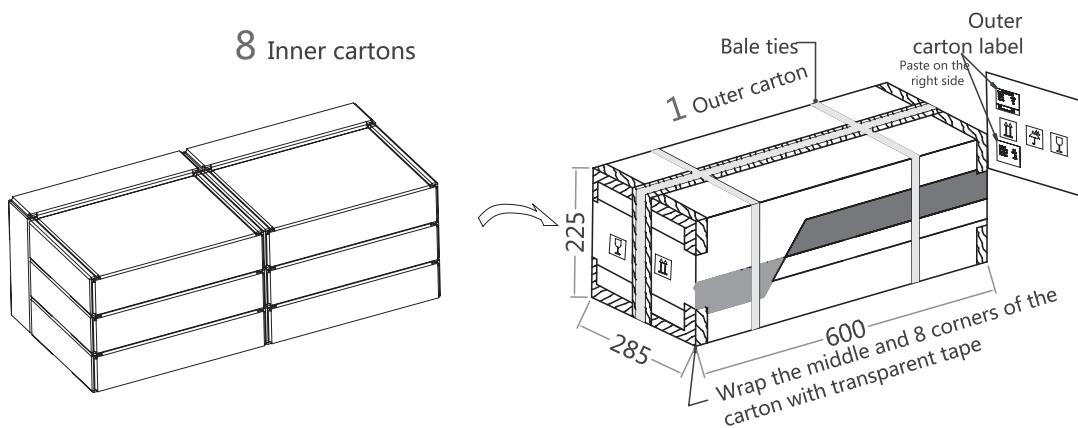
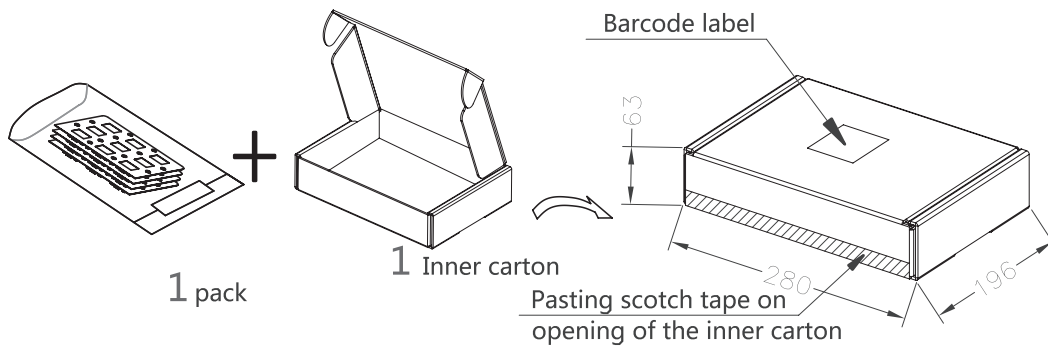
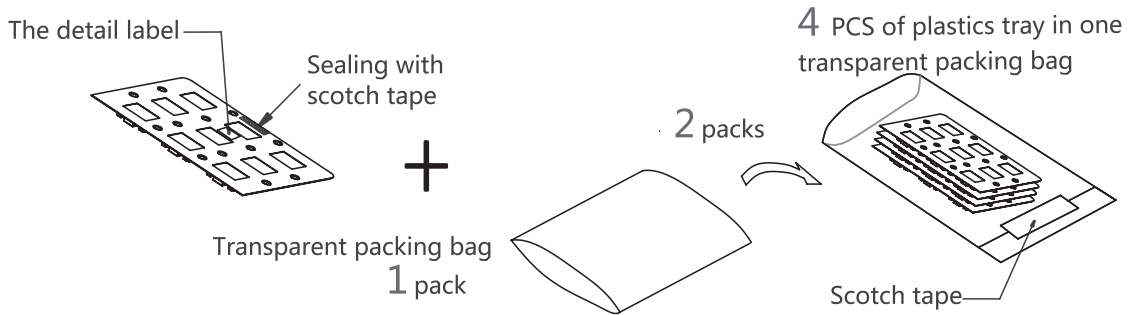
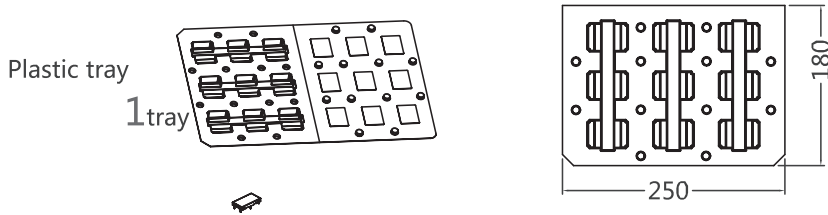



## REVISION HISTORY

---

rev.	description	date
1.0	initial release	06/24/2019

The revision history provided is for informational purposes only and is believed to be accurate.



**Headquarters**  
20050 SW 112th Ave.  
Tualatin, OR 97062  
**800.275.4899**

Fax 503.612.2383  
**cui.com**  
techsupport@cui.com

CUI offers a two (2) year limited warranty. Complete warranty information is listed on our website.

CUI reserves the right to make changes to the product at any time without notice. Information provided by CUI is believed to be accurate and reliable. However, no responsibility is assumed by CUI for its use, nor for any infringements of patents or other rights of third parties which may result from its use.

CUI products are not authorized or warranted for use as critical components in equipment that requires an extremely high level of reliability. A critical component is any component of a life support device or system whose failure to perform can be reasonably expected to cause the failure of the life support device or system, or to affect its safety or effectiveness.