

## Power cable - SAC-5P- 5,0-280/FRL FE SCO - 1414802

Please be informed that the data shown in this PDF Document is generated from our Online Catalog. Please find the complete data in the user's documentation. Our General Terms of Use for Downloads are valid (<http://phoenixcontact.com/download>)



Power cable, 5-position, PUR halogen-free, gray RAL 7001, Socket angled M12, coding: L, on free cable end, cable length: 5 m, for direct current up to 16 A/63 V

### Your advantages

- ✓ Easy and safe: 100% electrically tested plug-in components
- ✓ High-performance: DC connectors for up to 16 A and 63 V DC
- ✓ Protection against mismatching, thanks to special L-coding
- ✓ Our standard: robust halogen-free PUR cable



### Key Commercial Data

Packing unit	1 pc
GTIN	
GTIN	4055626034362
Weight per Piece (excluding packing)	922.920 g
Custom tariff number	85444290
Country of origin	Poland
Note	Made to Order (non-returnable)

### Technical data

#### Dimensions

Length of cable	5 m
-----------------	-----

#### Ambient conditions

Ambient temperature (operation)	-25 °C ... 85 °C (Plug / socket)
	-25 °C ... 85 °C (Plug / socket)
Degree of protection	IP65
	IP67

#### General

# Power cable - SAC-5P- 5,0-280/FRL FE SCO - 1414802

## Technical data

### General

Rated current at 40°C	16 A
Rated voltage	63 V DC
Number of positions	5
Color handle area	black
Insulation resistance	≥ 100 MΩ
Coding	L - Power
Standards/regulations	M12 connector IEC 61076-2-111
Status display	No
Protective circuit/component	unwired
Overvoltage category	III
Degree of pollution	3
Insertion/withdrawal cycles	≥ 100
Torque	0.4 Nm (M12 connector)

### Material

Flammability rating according to UL 94	V0
Contact material	CuZn
Contact surface material	Ni/Au
Contact carrier material	PA
Material of grip body	PP
Material, knurls	Zinc die-cast, nickel-plated

### Standards and Regulations

Standards/specifications	M12 connector IEC 61076-2-111
Flammability rating according to UL 94	V0

### Cable

Cable type	PUR halogen-free gray
Cable type (abbreviation)	280
UL AWM style	20233 / 10493 (80°C/300 V)
Conductor cross section	5x 2.5 mm <sup>2</sup>
AWG power supply	14
Conductor structure, voltage supply	141x 0.15 mm
Core diameter including insulation	2.85 mm ±0.1 mm
Thickness, insulation	≥ 0.31 mm
Wire colors	Brown, white, blue, black, gray
External sheath, color	gray RAL 7001
Outer sheath thickness	approx. 0.76 mm
External cable diameter D	9.65 mm ±0.25 mm
Minimum bending radius, fixed installation	5 x D
Minimum bending radius, flexible installation	10 x D
Number of bending cycles	4000000

# Power cable - SAC-5P- 5,0-280/FRL FE SCO - 1414802

## Technical data

### Cable

Minimum bending radius, drag chain applications	10 x D
Traversing path	10 m
Traversing rate	3 m/s
Acceleration	10 m/s <sup>2</sup>
Cable weight	185 kg/km
Outer sheath, material	PUR
Material conductor insulation	PP
Conductor material	Bare Cu litz wires
Insulation resistance	≥ 1 GΩ*km (at 20 °C)
Conductor resistance	≤ 8 Ω/km (at 20 °C)
Nominal voltage, cable	≤ 300 V AC
Test voltage, cable	≥ 3000 V AC (Spark test)
Other resistance	Hydrolysis and microbe resistant as per VDE 0282 section 10
	Low adhesion
	abrasion-resistant
	Resistant to salt water
Ambient temperature (operation)	-50 °C ... 80 °C (cable, fixed installation)
	-30 °C ... 80 °C (cable, flexible installation)

### Environmental Product Compliance

REACH SVHC	Lead 7439-92-1
China RoHS	Environmentally Friendly Use Period = 50 years
	For details about hazardous substances go to tab "Downloads", Category "Manufacturer's declaration"

## Drawings

Schematic diagram

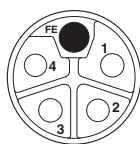

Pin assignment of M12 socket, 5-pos., L-coded, socket side view

Cable cross section

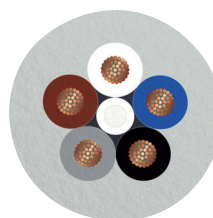

PUR halogen-free gray [280]

# Power cable - SAC-5P- 5,0-280/FRL FE SCO - 1414802

Diagram

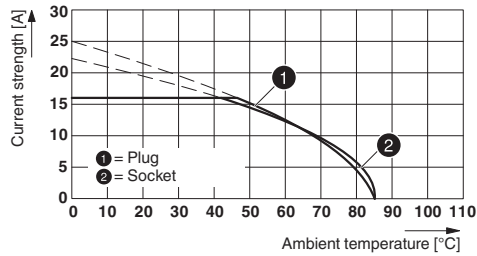

Dimensional drawing

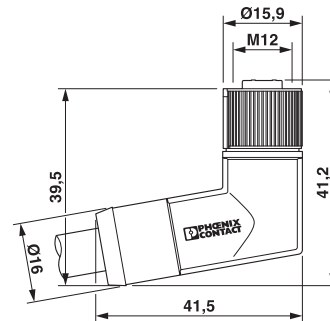

M12 x 1 socket, angled

Circuit diagram

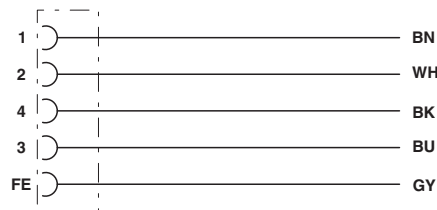

Contact assignment of the M12 socket

## Classifications

eCl@ss

eCl@ss 10.0.1	27440203
eCl@ss 11.0	27440203
eCl@ss 4.0	24010400
eCl@ss 4.1	24010400
eCl@ss 5.0	19030300
eCl@ss 5.1	19030300
eCl@ss 6.0	27279200
eCl@ss 7.0	27279218
eCl@ss 8.0	27440203
eCl@ss 9.0	27440203

ETIM

ETIM 3.0	EC002061
ETIM 4.0	EC001855
ETIM 5.0	EC002311
ETIM 6.0	EC002311
ETIM 7.0	EC002311

# Power cable - SAC-5P- 5,0-280/FRL FE SCO - 1414802

## Classifications

### UNSPSC

UNSPSC 6.01	31251501
UNSPSC 7.0901	31251501
UNSPSC 11	31251501
UNSPSC 12.01	31251501
UNSPSC 13.2	31251501
UNSPSC 18.0	27112301
UNSPSC 19.0	27112301
UNSPSC 20.0	27112301
UNSPSC 21.0	27112301

## Approvals

### Approvals

#### Approvals

UL Listed / cUL Listed / EAC-RoHS / EAC / cULus Listed

#### Ex Approvals

### Approval details

UL Listed		<a href="http://database.ul.com/cgi-bin/XYV/template/LISEXT/1FRAME/index.htm">http://database.ul.com/cgi-bin/XYV/template/LISEXT/1FRAME/index.htm</a>	E468743
Nominal voltage UN	63 V		
Nominal current IN	16 A		
mm²/AWG/kcmil	14		

cUL Listed		<a href="http://database.ul.com/cgi-bin/XYV/template/LISEXT/1FRAME/index.htm">http://database.ul.com/cgi-bin/XYV/template/LISEXT/1FRAME/index.htm</a>	E468743
Nominal voltage UN	63 V		
Nominal current IN	16 A		
mm²/AWG/kcmil	14		

EAC-RoHS		RU D- DE.HB35.B.00387
----------	---	--------------------------

## Power cable - SAC-5P- 5,0-280/FRL FE SCO - 1414802

### Approvals

EAC		RU C- DE.BL08.B.00286
-----	--	--------------------------

cULus Listed	
--------------	--

### Accessories

#### Accessories

#### Screwdriver tools

Tool - SAC BIT M12-D16 - 1200305



Nut for assembling sensor/actuator cables with M12 connector and M12 connectors for assembly, knurl diameter: 16 mm, for 4 mm hexagonal drive

Screw plug - PROT M12 MS PWR - 1092802



An M12 screw plug for the unoccupied M12 females of the M12 POWER connectors, boxes, and flush-type connectors