

## DESCRIPTION

The MPM3805B is an automotive-grade, step-down module converter with a built-in inductor and power MOSFETs. It achieves 0.6A of peak output current from a 2.5V to 6V input voltage range, with excellent load and line regulation. The output voltage is fixed to 1.2V, so the device only requires input and output capacitors to complete the design.

The device's integrated inductor simplifies the power system design and provides easy, efficient use. Constant-on-time (COT) control provides fast transient response and eases loop stabilization. Fault protections include cycle-by-cycle current limiting and thermal shutdown (TSD).

The MPM3805B is ideal for a wide range of automotive applications, including small ECUs, camera modules, telematics, and infotainment systems. It is available in a small, surface-mounted QFN-12 (2.5mmx3.0mmx0.9mm) package.

## FEATURES

- Guaranteed Industrial/Automotive Temp
- Wide 2.5V to 6V Operating Input Range
- Fixed 1.2V Output
- Up to 0.6A Peak Output Current
- 100% Duty Cycle in Dropout Mode
- Forced Continuous Conduction Mode (CCM)
- EN and Power Good for Power Sequencing
- Cycle-by-Cycle Over-Current Protection
- Short-Circuit Protection with Hiccup Mode
- Only Requires Two External Ceramic Capacitors
- Total Solution Size of 6mmx3.8mm
- Available in a QFN-12 (2.5mmx3.0mmx0.9mm) Package
- Available in AEC-Q100 Grade 1

## APPLICATIONS

- Automotive ECUs
- Rear Cameras
- E-Calls
- Telematics
- Infotainment Systems

All MPS parts are lead-free, halogen free, and adhere to the RoHS directive. For MPS green status, please visit the MPS website under Quality Assurance. "MPS", the MPS logo and "Simple, Easy Solutions" are registered trademarks of Monolithic Power Systems, Inc. or its subsidiaries.

## TYPICAL APPLICATION

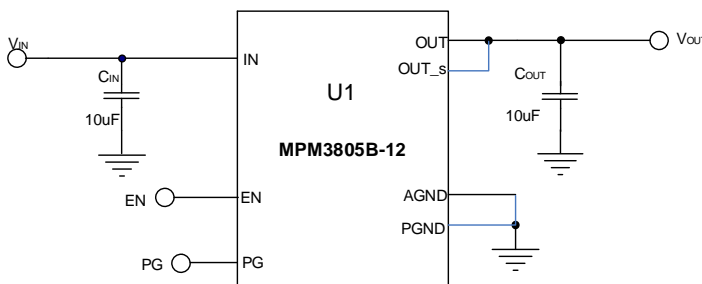

Efficiency vs. Load Current

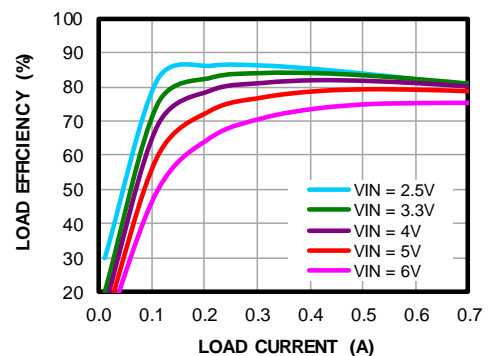

## ORDERING INFORMATION

Part Number*	Package	Top Marking	MSL Rating
MPM3805BGQB-12-AEC1	QFN-12 (2.5mmx3.0mmx0.9mm)	See Below	3

\* For Tape & Reel, add suffix -Z (e.g. MPM3805BGQB-12-AEC1-Z).

## TOP MARKING

**BJB**

**YWW**

**LLL**

BJB: Product code of MPM3805BGQB-12-AEC1

Y: Year code

WW: Week code

LLL: Lot number

## PACKAGE REFERENCE

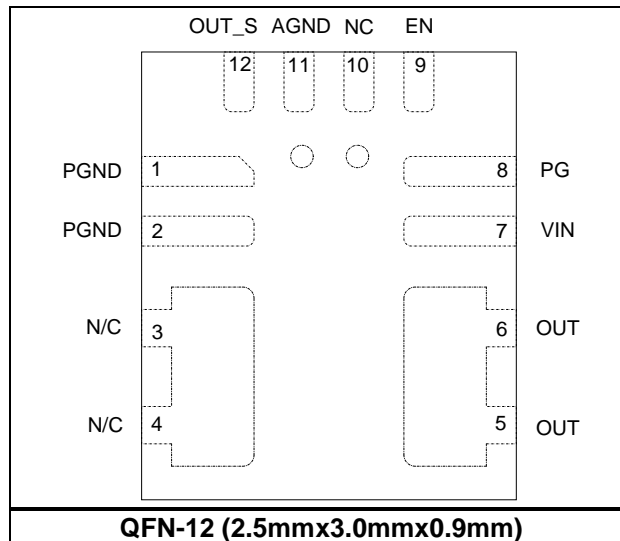

## PIN FUNCTIONS

Pin #	Name	Description
1, 2	PGND	<b>Power ground.</b>
3, 4	N/C	<b>Internal SW pad.</b>
5, 6	OUT	<b>Output voltage power rail.</b> Connect the load to OUT. An output capacitor is required.
7	VIN	<b>Supply voltage.</b> The MPM3805B operates from a 2.5V to 6V unregulated input voltage range. A decoupling capacitor is required to prevent large voltage spikes from appearing at the input. Place the decoupling capacitor as close to VIN as possible.
8	PG	<b>Power good indicator.</b> The output of PG is an open drain with an internal pull-up resistor to VIN. PG is pulled up to VIN when the feedback voltage ( $V_{FB}$ ) is within 10% of the regulation level. If $V_{FB}$ is out of the regulation range, PG is pulled low.
9	EN	<b>On/off control.</b>
10	NC	<b>No internal connection.</b>
11	AGND	<b>Analog ground for internal control circuit.</b>
12	OUT_S	<b>Output voltage sense.</b>

### ABSOLUTE MAXIMUM RATINGS <sup>(1)</sup>

Supply voltage ( $V_{IN}$ ) .....	6.5V
All other pins.....	-0.3V to +6.5V
Junction temperature .....	150°C
Lead temperature .....	260°C
Continuous power dissipation ( $T_A = 25^\circ\text{C}$ ) <sup>(2)</sup> .....	1.9W
Storage temperature.....	-65°C to +150°C

### ESD Rating

Human body model (HBM) .....	2kV
Charged device model (CDM).....	750V

### Recommended Operating Conditions

Supply voltage ( $V_{IN}$ ) .....	2.5V to 6V
Output voltage ( $V_{OUT}$ ).....	1.2V
Operating junction temp ( $T_J$ ) ....	-40°C to +125°C

<b>Thermal Resistance <sup>(3)</sup></b>	<b><math>\theta_{JA}</math></b>	<b><math>\theta_{JC}</math></b>
QFN-12 (2.5mmx3.0mm).....	65.....	13...°C/W

#### Notes:

- 1) Exceeding these ratings may damage the device.
- 2) The maximum allowable power dissipation is a function of the maximum junction temperature  $T_J$  (MAX), the junction-to-ambient thermal resistance  $\theta_{JA}$ , and the ambient temperature  $T_A$ . The maximum allowable continuous power dissipation at any ambient temperature is calculated by  $P_D$  (MAX) =  $(T_J$  (MAX) -  $T_A$ ) /  $\theta_{JA}$ . Exceeding the maximum allowable power dissipation produces an excessive die temperature, causing the device to go into thermal shutdown. Internal thermal shutdown circuitry protects the device from permanent damage.
- 3) Measured on JESD51-7, 4-layer PCB.

## ELECTRICAL CHARACTERISTICS

$V_{IN} = 5V$ ,  $T_J = -40^{\circ}C$  to  $+125^{\circ}C$ , unless otherwise noted. Typical values are at  $T_J = 25^{\circ}C$ .

Parameter	Symbol	Condition	Min	Typ	Max	Units	
Input voltage	$V_{IN}$		2.5		6.0	V	
Output voltage accuracy	$V_{OUT}$	$I_{OUT} = 10mA$ , $T_J = 25^{\circ}C$ , $V_{IN} = 5V$	1.17	1.200	1.23	V	
		$I_{OUT} = 10mA$ , $V_{IN} = 5V$ , $T_J = -40^{\circ}C$ to $+125^{\circ}C$	1.164	1.2	1.236		
PFET switch on resistance	$R_{DSON\_P}$			100	230	m $\Omega$	
NFET switch on resistance	$R_{DSON\_N}$			60	130	m $\Omega$	
Inductor L value	L	Inductance value at 1MHz		0.47		$\mu H$	
Inductor DC resistance	$R_{DCR}$			120		m $\Omega$	
Dropout resistance	$R_{DR}$	100% on duty		220		m $\Omega$	
Switch leakage		$V_{EN} = 0V$ , $V_{IN} = 6V$ , $V_{SW} = 0V$ and $6V$ , $T_J = 25^{\circ}C$		0	1	$\mu A$	
PFET current limit		$T_J = 25^{\circ}C$	1.6	2.1	2.6	A	
		$T_J = -40^{\circ}C$ to $+125^{\circ}C$	1.5		2.7		
On time	$t_{ON}$	$V_{IN} = 5V$	$T_J = 25^{\circ}C$	50	70	100	ns
			$T_J = -40^{\circ}C$ to $+125^{\circ}C$			110	
		$V_{IN} = 3.6V$	$T_J = 25^{\circ}C$	70	100	130	
			$T_J = -40^{\circ}C$ to $+125^{\circ}C$			140	
Switching frequency	$f_{SW}$	$V_{IN} = 3.6V$ to $5V$	$T_J = 25^{\circ}C$	2.7	3.5	4.2	MHz
			$T_J = -40^{\circ}C$ to $+125^{\circ}C$	2.4			
Minimum off time	$t_{MIN-OFF}$			60		ns	
Soft-start time	$t_{SS-ON}$			1.5		ms	
Power good upper trip threshold	$PG_H$	FB voltage in respect to the regulation		+10		%	
Power good lower trip threshold	$PG_L$			-10		%	
Power good delay	$PG_D$			50		$\mu s$	
Power good sink current capability	$V_{PG-L}$	Sink 1mA			0.4	V	
Power good logic high voltage	$V_{PG-H}$	$V_{IN} = 5V$ , $V_{FB} = 0.6V$	4.9			V	
Power good internal pull-up resistor	$R_{PG}$			550		k $\Omega$	

**ELECTRICAL CHARACTERISTICS (continued)**
 $V_{IN} = 5V$ ,  $T_J = -40^{\circ}C$  to  $+125^{\circ}C$ , unless otherwise noted. Typical value are at  $T_J = 25^{\circ}C$ .

Parameter	Symbol	Condition	Min	Typ	Max	Units
Under-voltage lockout rising threshold			2.2	2.4	2.6	V
Under-voltage lockout hysteresis threshold				300		mV
EN input logic low voltage					0.4	V
EN input logic high voltage			1.2			V
EN input current		$V_{EN} = 2V$		1.5		$\mu A$
		$V_{EN} = 0V$		0.1	1	$\mu A$
Supply current (shutdown)		$V_{EN} = 0V$ , $T_J = 25^{\circ}C$			1	$\mu A$
		$V_{EN} = 0V$ , $T_J = -40^{\circ}C$ to $+125^{\circ}C$			10	
Supply current (quiescent)		$V_{EN} = 2V$ , $V_{FB} = 0.63V$ , $V_{IN} = 5V$ , $T_J = 25^{\circ}C$		485	560	$\mu A$
		$V_{EN} = 2V$ , $V_{FB} = 0.63V$ , $V_{IN} = 5V$ , $T_J = -40^{\circ}C$ to $+125^{\circ}C$			580	
Thermal shutdown <sup>(4)</sup>				150		$^{\circ}C$
Thermal hysteresis <sup>(4)</sup>				30		$^{\circ}C$

**Note:**

4) Not production tested, guaranteed by design.

## TYPICAL PERFORMANCE CHARACTERISTICS

$V_{IN} = 5V$ ,  $V_{OUT} = 1.2V$ ,  $C_{IN} = 10\mu F$ ,  $C_{OUT} = 20\mu F$ ,  $T_A = 25^\circ C$ , unless otherwise noted.

Efficiency vs. Load Current

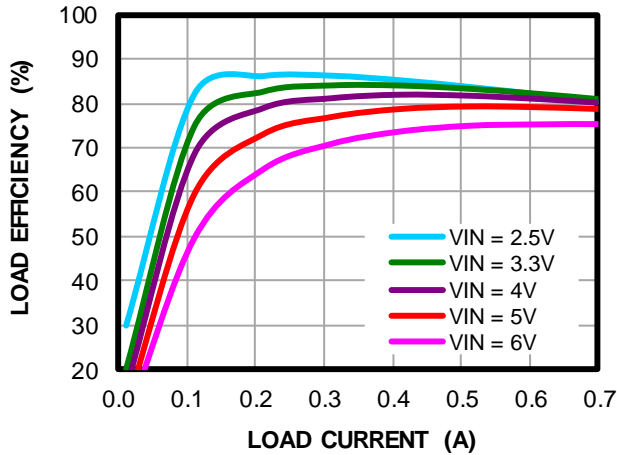

Line Efficiency

$I_{OUT} = 0.3A$

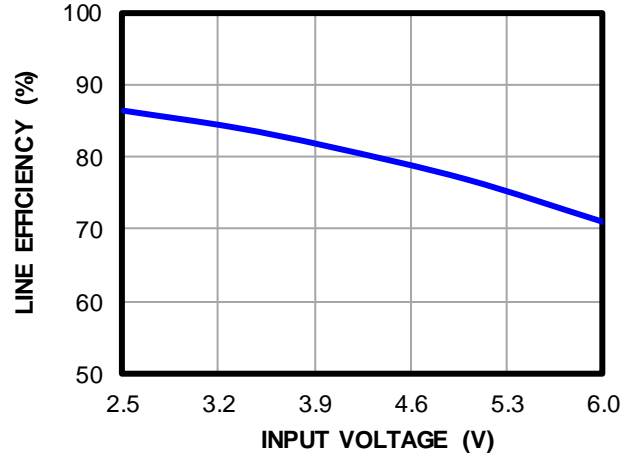

Load Regulation

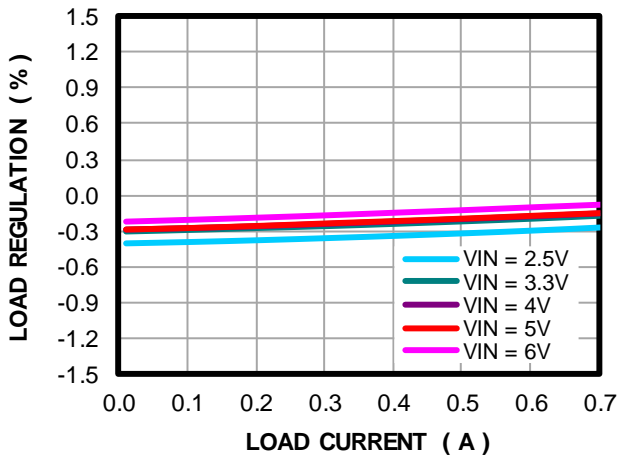

Line Regulation

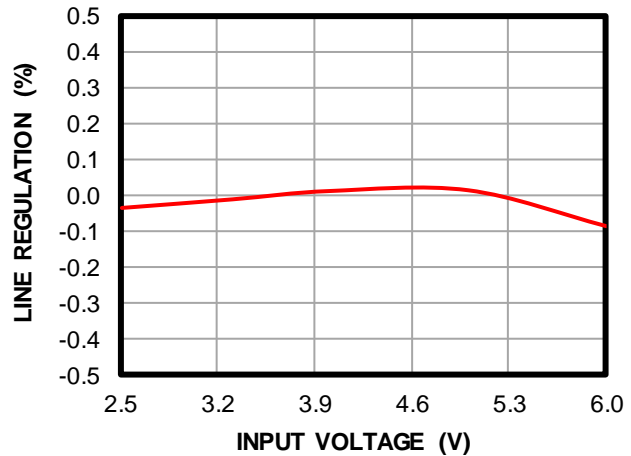

Load Efficiency vs. Temperature

$I_{OUT} = 0.35A$

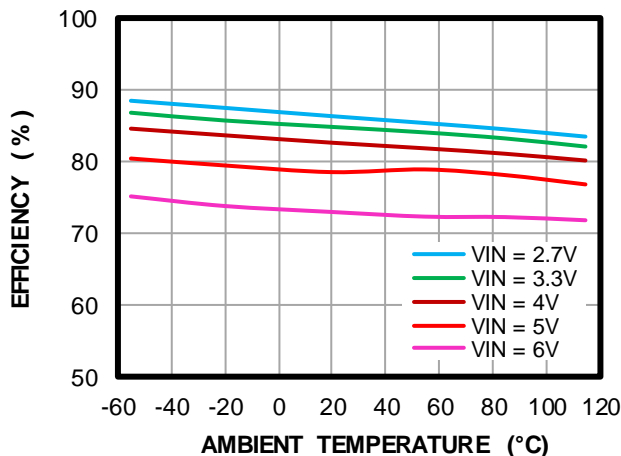

Line Efficiency

$I_{OUT} = 0.45A$

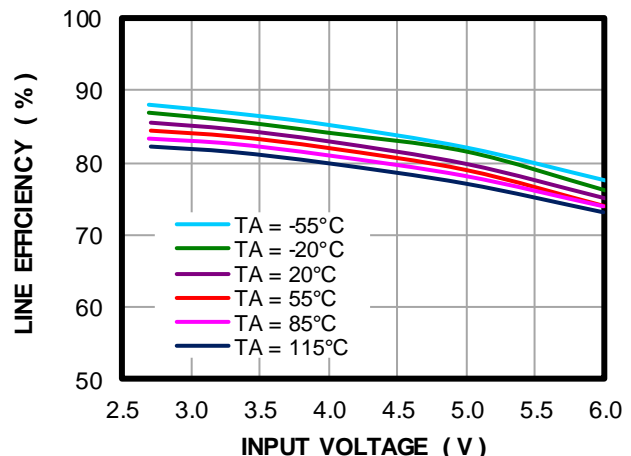

### TYPICAL PERFORMANCE CHARACTERISTICS *(continued)*

$V_{IN} = 5V$ ,  $V_{OUT} = 1.2V$ ,  $C_{IN} = 10\mu F$ ,  $C_{OUT} = 20\mu F$ ,  $T_A = 25^\circ C$ , unless otherwise noted.

**Line Regulation**

$I_{OUT} = 0.45A$

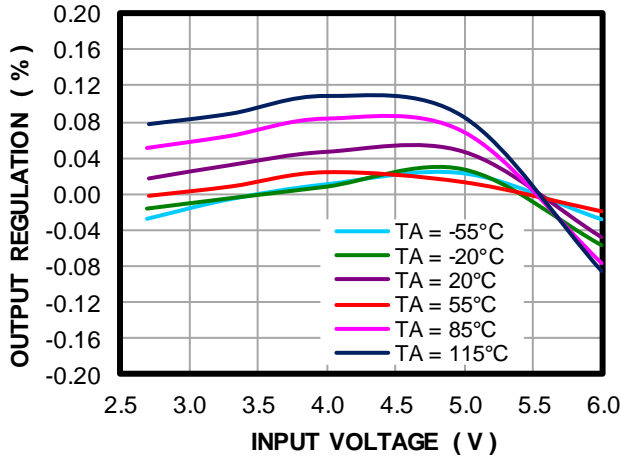

**Load Regulation vs. Temperature**

$I_{OUT} = 0.35A$

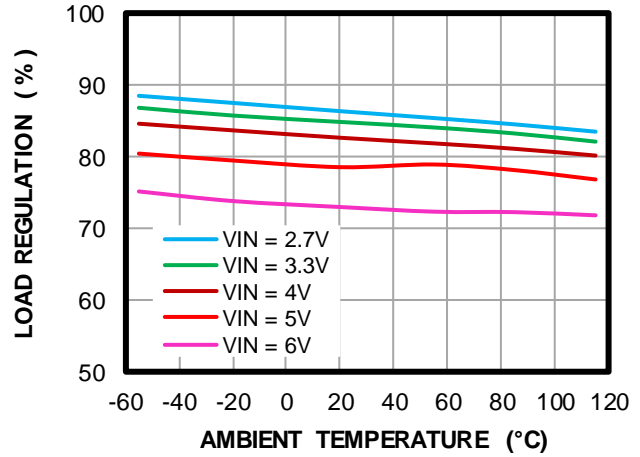

**Efficiency vs. Temperature**

$I_{OUT} = 0.35A$

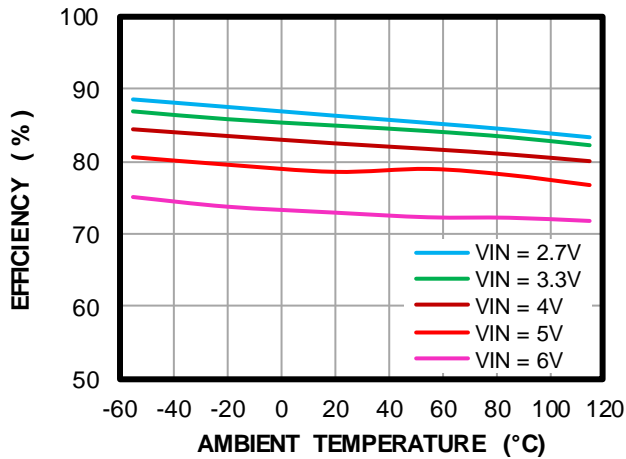

**Line Efficiency vs. Temperature**

$I_{OUT} = 0.35A$

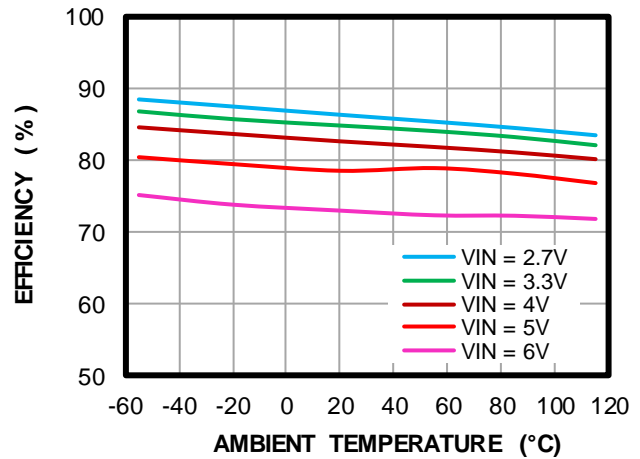

**Switching Frequency vs. Temperature**

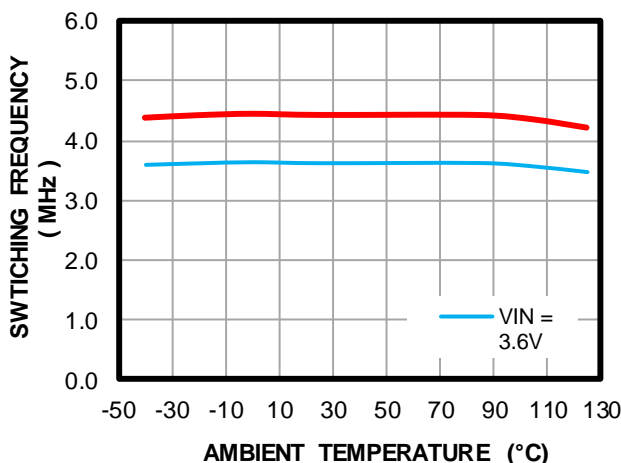

**Enable Threshold Voltage vs. Temperature**

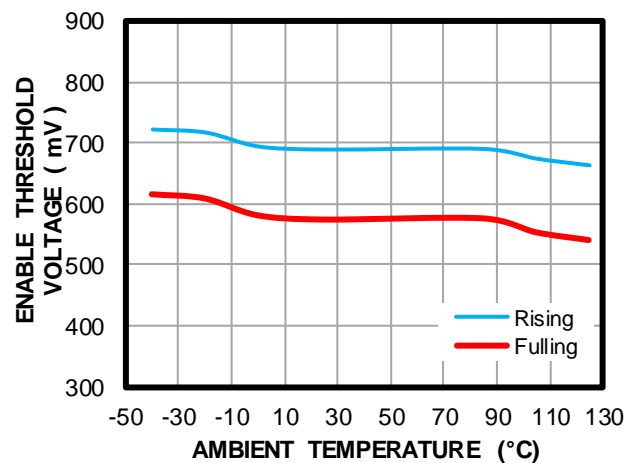

### TYPICAL PERFORMANCE CHARACTERISTICS *(continued)*

$V_{IN} = 5V$ ,  $V_{OUT} = 1.2V$ ,  $C_{IN} = 10\mu F$ ,  $C_{OUT} = 20\mu F$ ,  $T_A = 25^\circ C$ , unless otherwise noted.

**UVLO Threshold Voltage vs. Temperature**

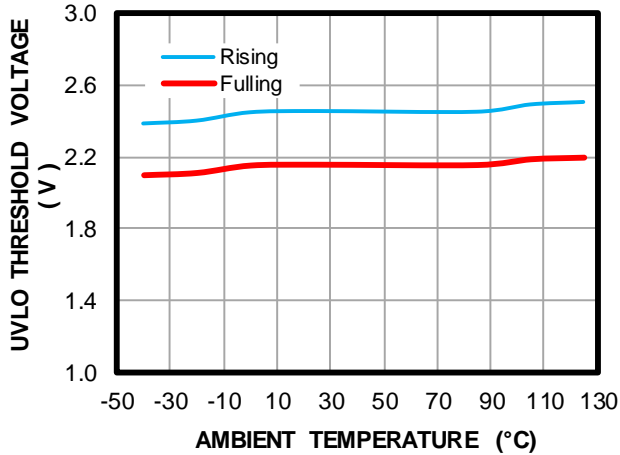

**FB Voltage vs. Temperature**

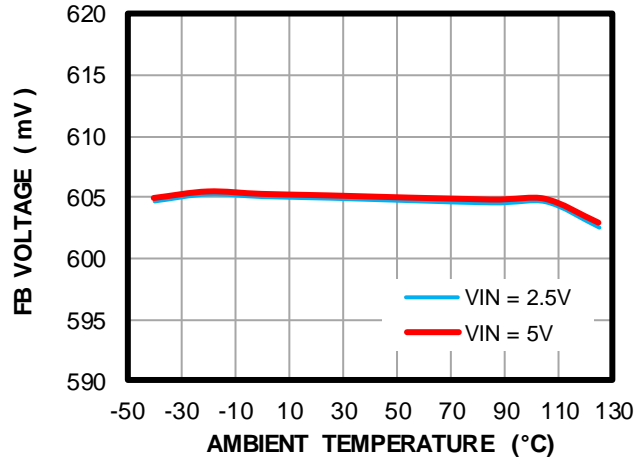

**IQ Current vs. Temperature**

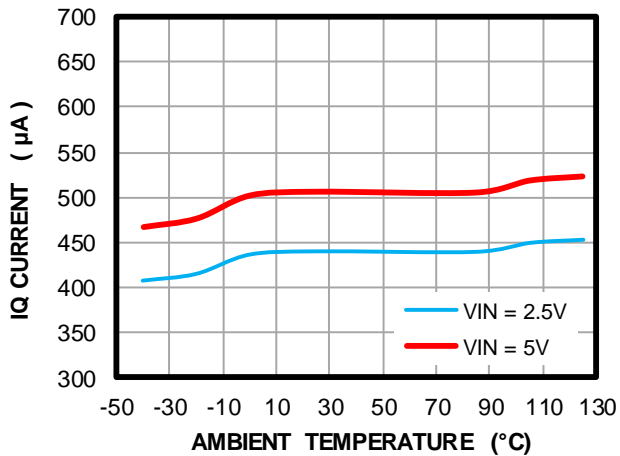

**Output Voltage vs. Temperature**

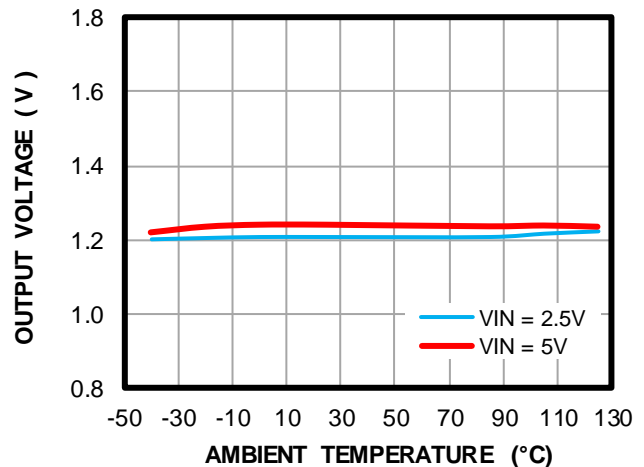

**Shutdown Current vs. Temperature**

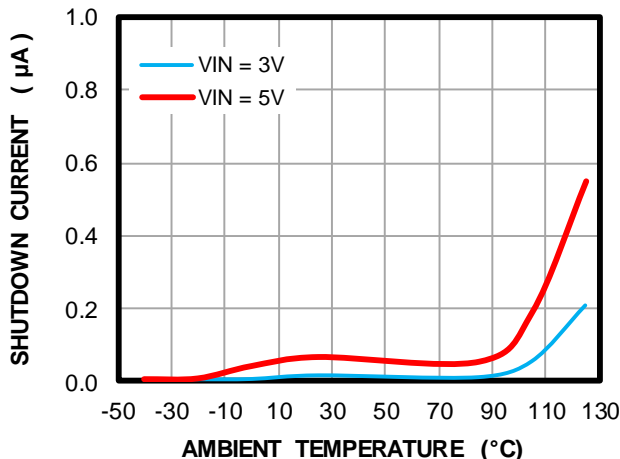

**Shutdown Current vs. VIN**

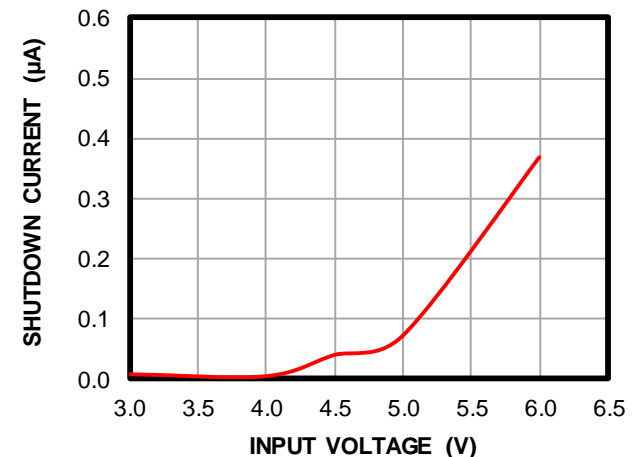

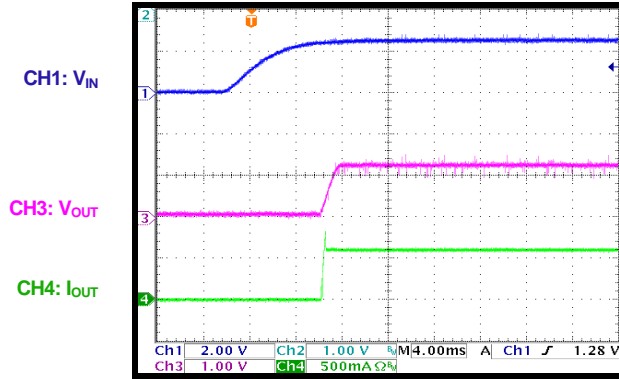
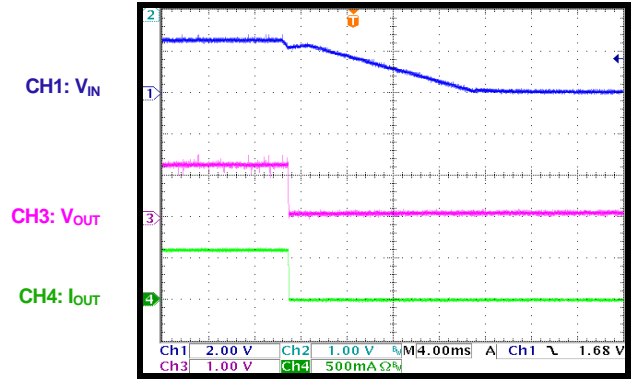
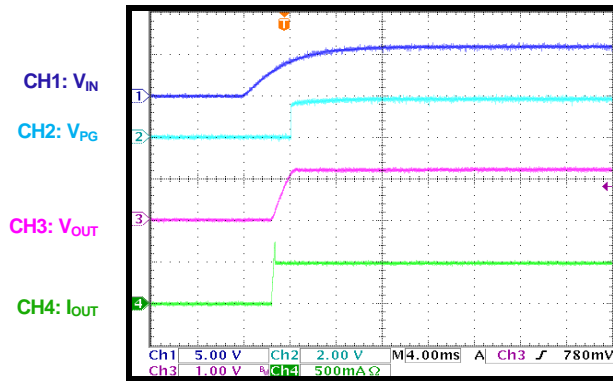
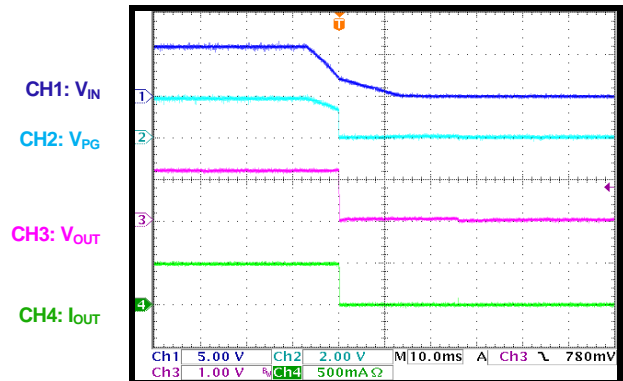
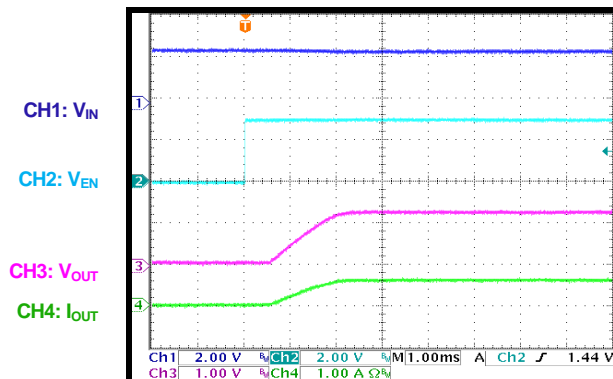
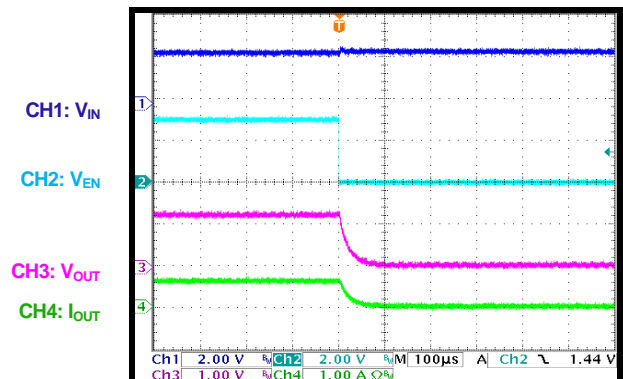

**TYPICAL PERFORMANCE CHARACTERISTICS (continued)**
 $V_{IN} = 5V, V_{OUT} = 1.2V, C_{IN} = 10\mu F, C_{OUT} = 20\mu F, T_A = 25^\circ C$ , unless otherwise noted.

**Start-Up**
 $V_{IN} = 2.5V, I_{OUT} = 0.6A$ 

**Shutdown**
 $V_{IN} = 2.5V, I_{OUT} = 0.6A$ 

**Start-Up**
 $V_{IN} = 6V, I_{OUT} = 0.5A$ 

**Shutdown**
 $V_{IN} = 6V, I_{OUT} = 0.5A$ 

**Enable On**
 $V_{IN} = 2.5V, I_{OUT} = 0.6A$ 

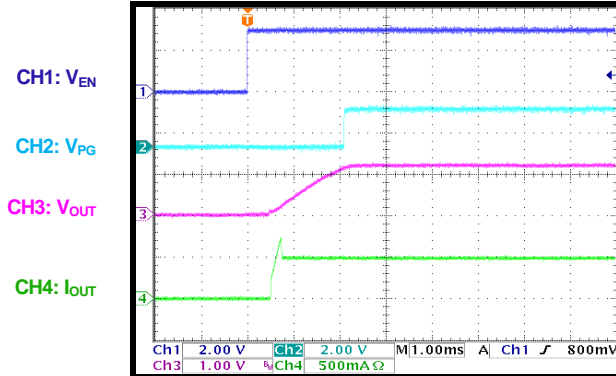
**Enable Off**
 $V_{IN} = 2.5V, I_{OUT} = 0.6A$ 

### TYPICAL PERFORMANCE CHARACTERISTICS (continued)

$V_{IN} = 5V$ ,  $V_{OUT} = 1.2V$ ,  $C_{IN} = 10\mu F$ ,  $C_{OUT} = 20\mu F$ ,  $T_A = 25^\circ C$ , unless otherwise noted.

#### Enable On

$V_{IN} = 6V$ ,  $I_{OUT} = 0.5A$



#### Enable Off

$V_{IN} = 6V$ ,  $I_{OUT} = 0.5A$

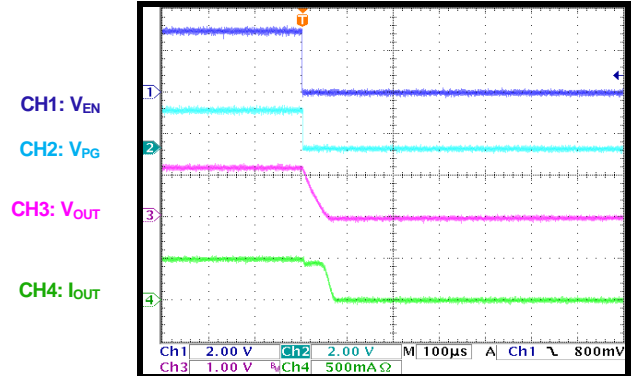

#### Steady State

$V_{IN} = 5V$ ,  $I_{OUT} = 0.6A$

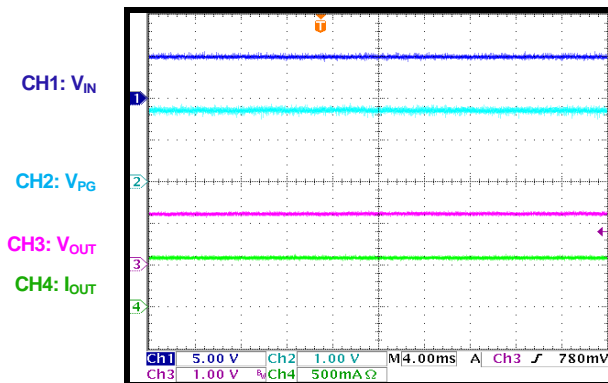

#### Steady State

$V_{IN} = 2.5V$ ,  $I_{OUT} = 0.6A$

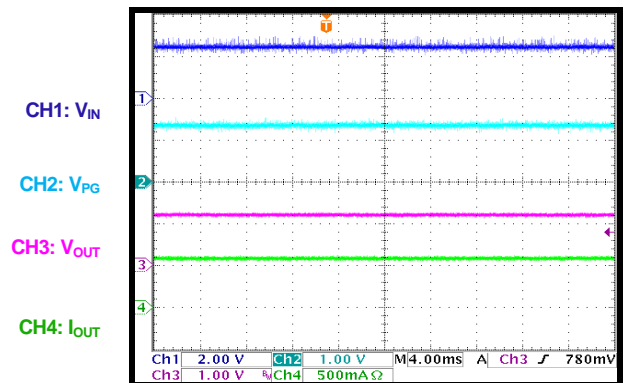

#### Short Circuit

$V_{IN} = 5V$

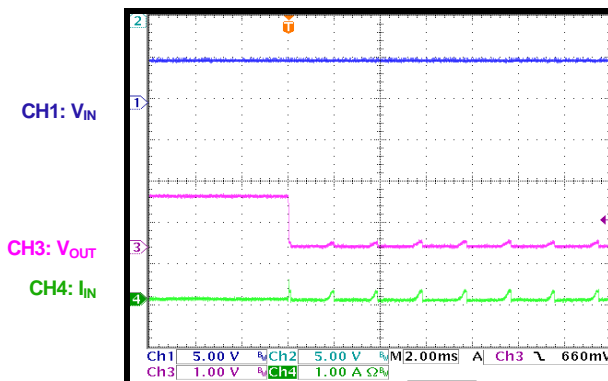

#### Short-Circuit Recovery

$V_{IN} = 5V$

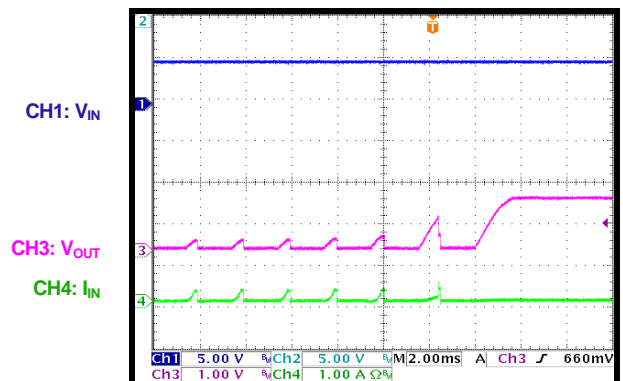

**TYPICAL PERFORMANCE CHARACTERISTICS (continued)**

$V_{IN} = 5V$ ,  $V_{OUT} = 1.2V$ ,  $C_{IN} = 10\mu F$ ,  $C_{OUT} = 20\mu F$ ,  $T_A = 25^\circ C$ , unless otherwise noted.

**Transient Response**

$V_{IN} = 2.5V$ ,  $I_{OUT} = 0A$  to  $0.6A$ ,  $0.25A/\mu s$

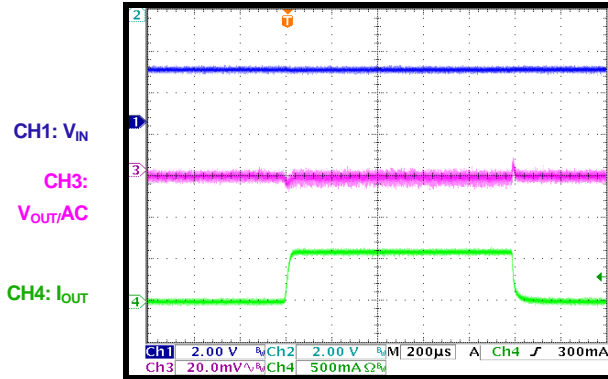

**Transient Response**

$V_{IN} = 3.3V$ ,  $I_{OUT} = 0A$  to  $0.6A$ ,  $0.25A/\mu s$

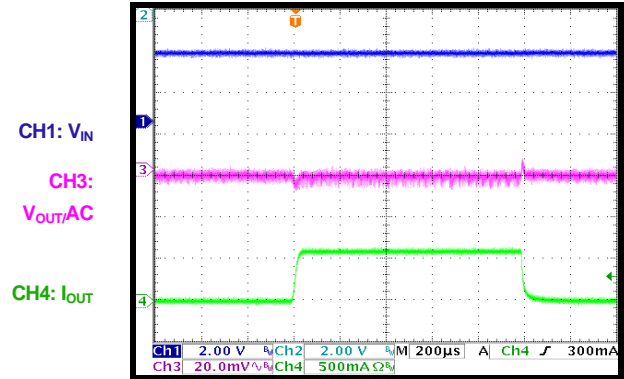

**Transient Response**

$V_{IN} = 6V$ ,  $I_{OUT} = 0A$  to  $0.6A$ ,  $0.25A/\mu s$

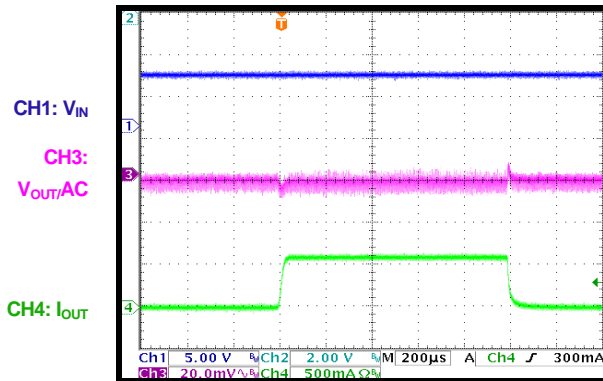

## FUNCTIONAL BLOCK DIAGRAM

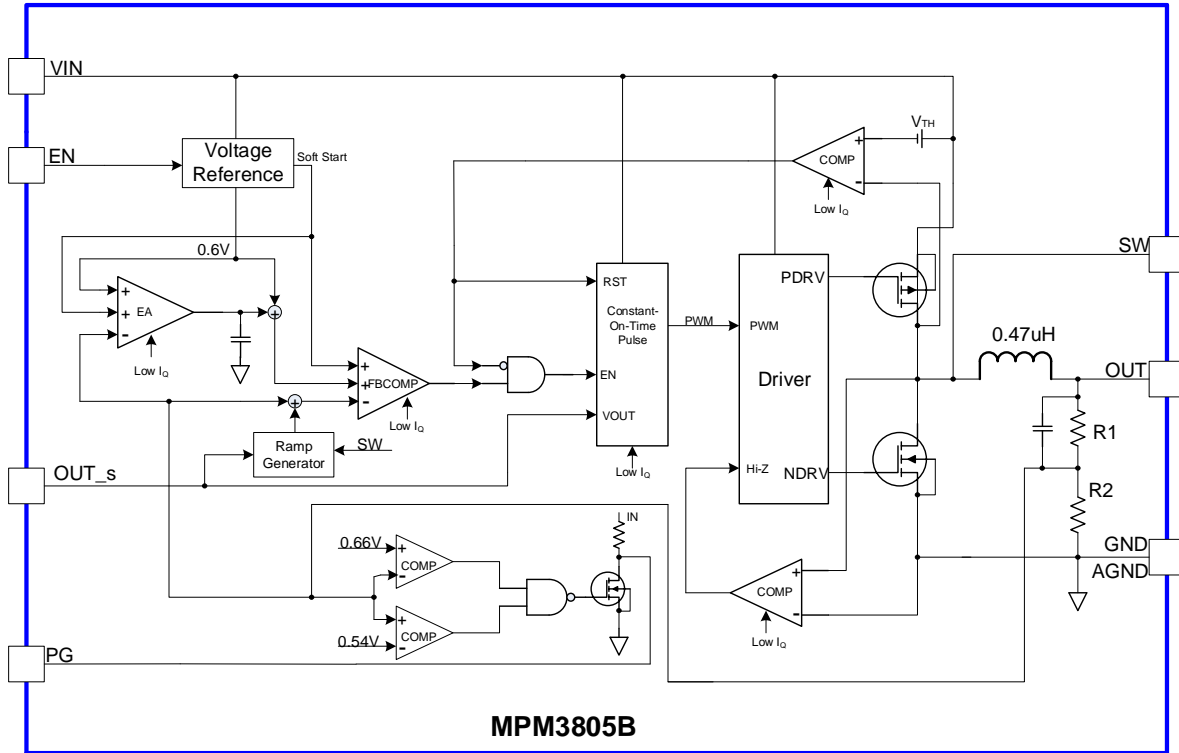

Figure 1: Functional Block Diagram

## OPERATION

The MPM3805B's integrated inductor simplifies the schematic and layout design. Only input and output capacitors are required to complete the design. The MPM3805B uses constant-on-time (COT) control with input voltage feed forward to stabilize the switching frequency over the full input range. At light-load, the device employs proprietary control of the low-side switch and inductor current to improve efficiency. It is available in a small, surface-mounted QFN-12 (2.5mmx3.0mmx0.9mm) package.

### Constant-On-Time Control (COT)

Compared to fixed-frequency pulse-width modulation (PWM) control, constant-on-time control (COT) offers a simpler control loop and faster transient response. Using input voltage feed forward, the MPM3805B maintains a nearly constant switching frequency across the input and output voltage range.

The on time of the switching pulse can be estimated with Equation (1):

$$t_{ON} = \frac{V_{OUT}}{V_{IN}} \times 0.28\mu s \quad (1)$$

To prevent inductor current runaway during the load transition, the MPM3805B fixes the minimum off time to 60ns. However, this time limit does not affect operation in a steady state.

The MPM3805B works in forced continuous conduction mode (CCM).

### Enable (EN)

If the input voltage exceeds the under-voltage lockout (UVLO) threshold (typically 2.3V), the MPM3805B is enabled by pulling EN above 1.2V. Float EN floating or pull it to ground to disable the MPM3805B. There is an internal 1M $\Omega$  resistor from EN to ground.

### Soft Start (SS)

The MPM3805B has a built-in soft start that ramps up the output voltage in a controlled slew rate. This avoids overshoot at start-up. The soft-start time is about 1.5ms.

### Power Good Indicator (PGOOD)

The MPM3805B has an open drain with a 550k $\Omega$  pull-up resistor pin for the power good indicator

(PGOOD). When the feedback voltage ( $V_{FB}$ ) is within  $\pm 10\%$  of the regulation voltage (e.g. 0.6V), PGOOD is pulled up to IN by the internal resistor. If  $V_{FB}$  is out of the  $\pm 10\%$  window, PGOOD is pulled down to ground by an internal MOSFET. The MOSFET has a maximum  $R_{DS(ON)}$  below 400 $\Omega$ .

### Current Limit

The MPM3805B has a typical 2.1A current limit for the high-side switch. When the high-side switch reaches the current limit, the MPM3805B reaches the hiccup threshold until the current decreases. This prevents the inductor current from continuing to build, which could damage to the components.

### Short Circuit and Recovery

The MPM3805B enters short-circuit protection (SCP) mode when the current limit is reached. It tries to recover from the short circuit with hiccup mode. When an SCP condition occurs, the MPM3805B disables the output power stage, discharges the soft-start capacitor, then automatically tries to soft start again. If the short-circuit condition remains after the soft start ends, The MPM3805B repeats the cycle until the short circuit disappears, and the output rises back to the regulation level.

## APPLICATION INFORMATION

### COMPONENT SELECTION

#### Selecting the Input Capacitor

The step-down converter has a discontinuous input current, and requires a capacitor to supply the AC current while maintaining the DC input voltage. For optimal performance, use low-ESR capacitors. Ceramic capacitors with X5R or X7R dielectrics are highly recommended due to their low ESR and small temperature coefficients. For most applications, a 10 $\mu$ F capacitor is sufficient.

For an output capacitor, a 22 $\mu$ F capacitor may be needed to enhance system stability.

Since the input capacitor absorbs the input switching current, it requires an adequate ripple current rating. The RMS current in the input capacitor can be estimated with Equation (2):

$$I_{C1} = I_{LOAD} \times \sqrt{\frac{V_{OUT}}{V_{IN}} \times \left(1 - \frac{V_{OUT}}{V_{IN}}\right)} \quad (2)$$

The worst-case condition occurs at  $V_{IN} = 2V_{OUT}$ , calculated with Equation (3):

$$I_{C1} = \frac{I_{LOAD}}{2} \quad (3)$$

For simplification, choose an input capacitor that has an RMS current rating greater than half of the maximum load current.

The input capacitor can be electrolytic, tantalum or ceramic. When using electrolytic or tantalum capacitors, add a small, high-quality ceramic capacitor (e.g. 0.1 $\mu$ F) as close to the IC as possible. When using ceramic capacitors, ensure that they have enough capacitance to provide sufficient charge to prevent an excessive voltage ripple at the input. The input voltage ripple caused by capacitance can be estimated with Equation (4):

$$\Delta V_{IN} = \frac{I_{LOAD}}{f_{SW} \times C1} \times \frac{V_{OUT}}{V_{IN}} \times \left(1 - \frac{V_{OUT}}{V_{IN}}\right) \quad (4)$$

#### Selecting the Output Capacitor

The output capacitor ( $C_{OUT}$ ) is required to maintain the DC output voltage. Ceramic capacitors are recommended. Low-ESR

capacitors are recommended to maintain a low output voltage ripple. The output voltage ripple can be calculated with Equation (5):

$$\Delta V_{OUT} = \frac{V_{OUT}}{f_{SW} \times L_1} \times \left(1 - \frac{V_{OUT}}{V_{IN}}\right) \times \left(R_{ESR} + \frac{1}{8 \times f_s \times C2}\right) \quad (5)$$

Where  $L_1$  is the inductor value, and  $R_{ESR}$  is the equivalent series resistance (ESR) value of the output capacitor ( $L_1$  is 0.47 $\mu$ H).

When using ceramic capacitors, the capacitance dominates impedance at the switching frequency, and causes most of the output voltage ripple. For simplification, the output voltage ripple can be estimated with Equation (6):

$$\Delta V_{OUT} = \frac{V_{OUT}}{8 \times f_{SW}^2 \times L_1 \times C2} \times \left(1 - \frac{V_{OUT}}{V_{IN}}\right) \quad (6)$$

When using tantalum or electrolytic capacitors, the ESR dominates the impedance at the switching frequency. For simplification, the output ripple can be calculated with Equation (7):

$$\Delta V_{OUT} = \frac{V_{OUT}}{f_{SW} \times L_1} \times \left(1 - \frac{V_{OUT}}{V_{IN}}\right) \times R_{ESR} \quad (7)$$

The characteristics of the output capacitor affect the stability of the regulation system.

#### PCB Layout Guidelines

Efficient PCB layout is critical for stable operation. The device's integrated inductor simplifies the schematic and layout design. Input and output capacitors are required to complete the design. For the best results, refer to Figure 3 and Figure 4 and follow the guidelines below:

1. Place the high-current paths (PGND, IN and OUT) close to the device with short, direct, and wide traces.
2. Place the input capacitor as close to IN and PGND as possible.
3. Keep the switching node away from the feedback network.

For additional device applications, refer to the related evaluation board datasheets.

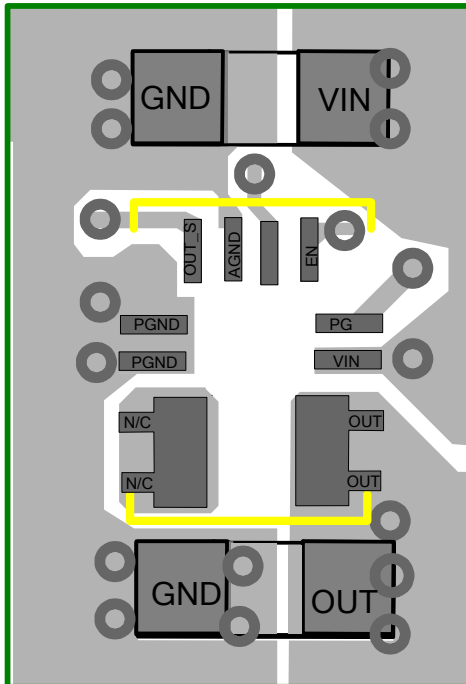

Figure 2: Top View of PCB Layout

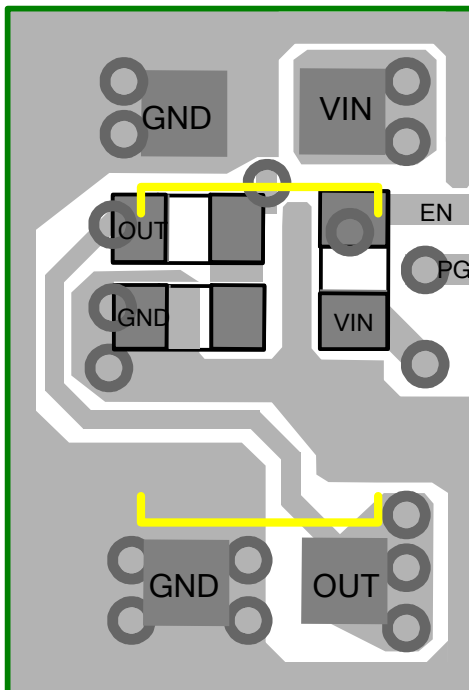

Figure 3: Bottom View of PCB Layout

### TYPICAL APPLICATION CIRCUIT

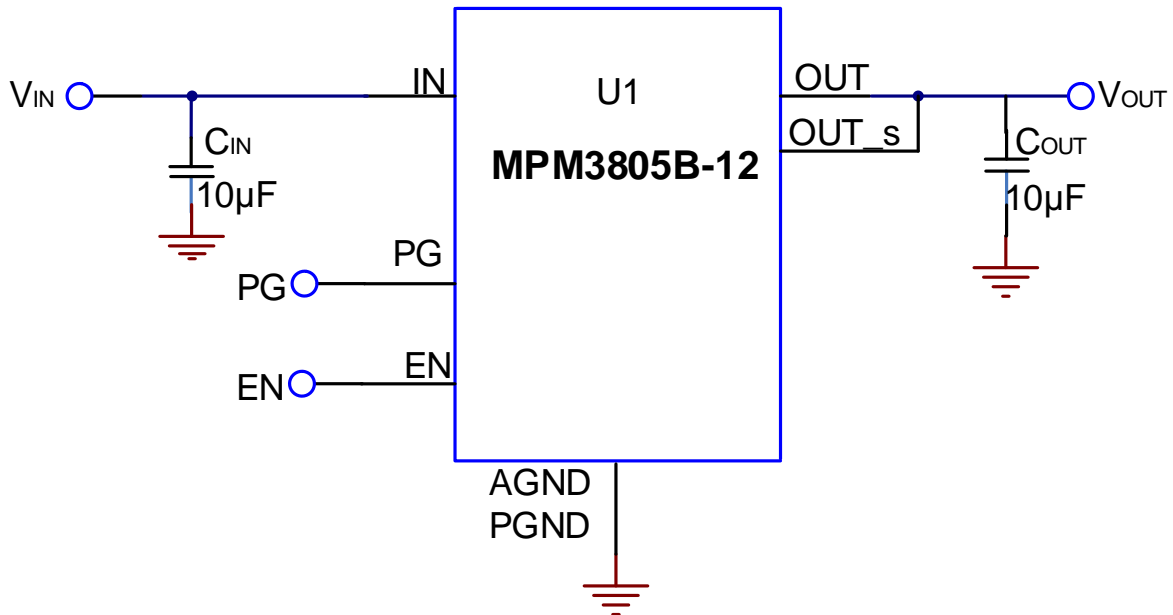
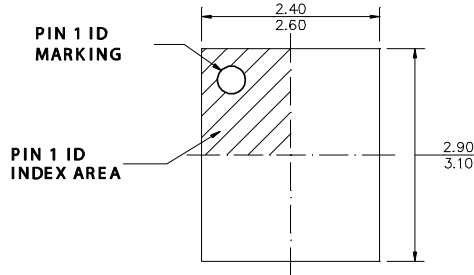

Figure 4: Typical Application Circuit



## PACKAGE INFORMATION

### QFN-12 (2.5mmx3.0mmx0.9mm)



**TOP VIEW**

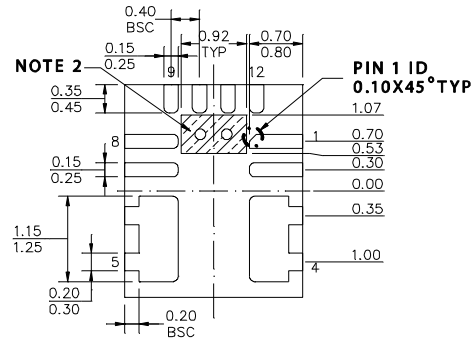

**BOTTOM VIEW**

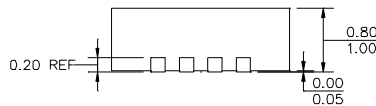

**SIDE VIEW**

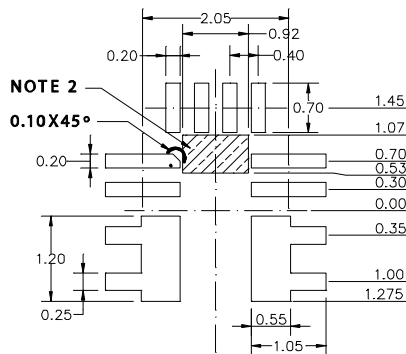

**RECOMMENDED LAND PATTERN**

#### NOTE:

- 1) ALL DIMENSIONS ARE IN MILLIMETERS
- 2) SHADED AREA IS THE KEEPOUT ZONE. THE EXPOSED BOTTOM METAL PADS ENCLOSED BY THIS ZONE IS NOT TO BE CONNECTED TO ANY PCB METAL TRACE & VIA ELECTRICALLY OR MECHANICALLY.
- 3) EXPOSED PADDLE SIZE DOES NOT INCLUDE MOLD FLASH.
- 4) LEAD COPLANARITY SHALL BE 0.10 MILLIMETERS MAX
- 5) JEDEC REFERENCE IS MQ220.
- 6) DRAWING IS NOT TO SCALE

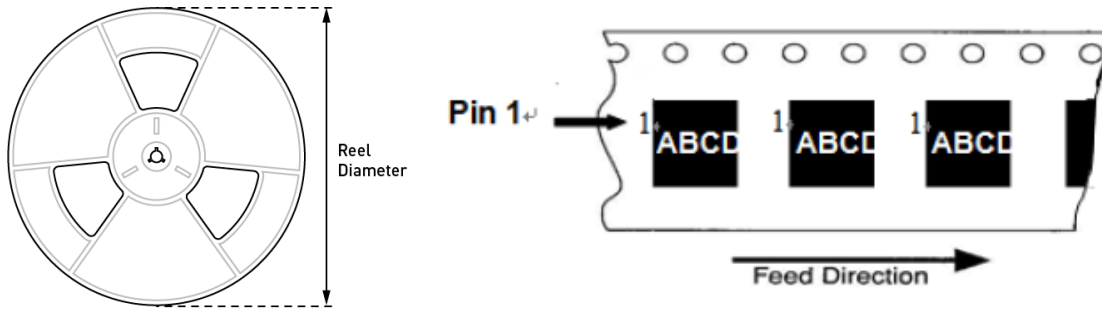
**CARRIER INFORMATION**

Part Number	Package Description	Quantity /Reel	Quantity /Tube	Reel Diameter	Carrier Tape Width	Carrier Tape Pitch
MPM3805BGQB-12-AEC1-Z	QFN-12 (2.5mmx3.0mmx0.9mm)	5000	N/A	13in	12mm	8mm

**Notice:** The information in this document is subject to change without notice. Please contact MPS for current specifications. Users should warrant and guarantee that third-party Intellectual Property rights are not infringed upon when integrating MPS products into any application. MPS will not assume any legal responsibility for any said applications.