

TB RELAYS POWER TYPE

High Carrying Current 1 Form A Type Relay for Miniature PC board

◁ Protective construction ▷
 High heat-resistant type: Sealed
 Pin in Paste compliant type: Flux tight

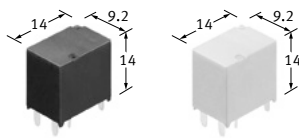

(Unit: mm)

FEATURES

- Compact, 30 A and supports fuse.
- Supports capacitor loads and low operating power type.
- Pin in Paste compliant model added.

TYPICAL APPLICATIONS

- Defoggers, Ignitions, Seat heaters and Powered windows, etc

ORDERING INFORMATION (PART NO.)

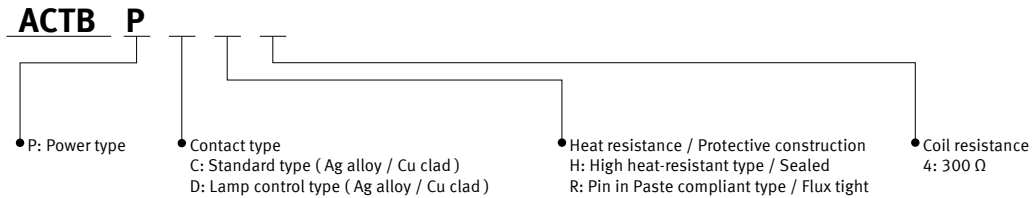

TYPES

Contact arrangement	Contact type	Rated coil voltage	Coil resistance	Part No.		Packing	
				Heat resistance		Carton	Case
				High heat-resistant type	Pin in Paste compliant type		
1 Form A	Standard type (Ag alloy / Cu clad)	12 V DC	300 Ω	ACTBPCH4	ACTBPCR4	50 pcs.	2,000 pcs.
	Lamp control type (Ag alloy / Cu clad)			ACTBPDH4	ACTBPDR4*		

*Please order "ACTBPDR4V" (standard stock part number).
 The letter of suffix "V" is not marked on the device (relay). It is only marked on the inner and outer carton.

RATING

Coil data

Rated coil voltage	Operate (Set) voltage (at 20°C)(Initial)	Release (Reset) voltage (at 20°C)(Initial)	Rated operating current (±10%, at 20°C)	Coil resistance (±10%, at 20°C)	Rated operating power (at 20°C)	Usable voltage range
12 V DC	Max. 7.0 V DC	Min. 0.5 V DC	40 mA	300 Ω	480 mW	10 to 16 V DC

Note: Other operate (set) voltage types are also available. Please inquire our sales representative for details.

Automotive Relays TB RELAYS POWER TYPE

Specifications

Item		Specifications	
Contact data	Contact arrangement	1 Form A	
	Contact resistance (initial)	Max. 50 mΩ (typ. 3 mΩ) (by voltage drop 1 A 6 V DC)	
	Contact material	Ag alloy	
	Rated switching capacity (resistive)	30 A 14 V DC	
	Max. carrying current (initial)*1	30 A/1 hour (12 V DC at 20°C)	
	Min. switching load (resistive)*2	1 A 14 V DC (at 20°C)	
Insulated resistance (initial)		Min. 100 MΩ (at 500 V DC, Measured portion is the same as the case of dielectric strength.)	
Dielectric strength (initial)	Between open contacts	500 V AC for 1 min (detection current: 10 mA)	
	Between contacts and coil	500 V AC for 1 min (detection current: 10 mA)	
Time characteristics (initial)	Operate (Set) time (at rated voltage)	Max. 10 ms (at 20°C, without contact bounce time)	
	Release (Reset) time (at rated voltage)	Max. 10 ms (at 20°C, without contact bounce time, without diode)	
Shock resistance	Functional	Min. 100 m/s ² (half-wave pulse of sine wave: 11 ms, detection time: 10 μs)	
	Destructive	Min. 1,000 m/s ² (half-wave pulse of sine wave: 6 ms)	
Vibration resistance	Functional	10 to 100 Hz, Min. 44.1 m/s ² (detection time: 10 μs)	
	Destructive	10 to 500 Hz, Min. 44.1 m/s ² Time of vibration for each direction; X, Y direction: 2 hours, Z direction: 4 hours	
Expected life	Mechanical		
	Electrical	Standard type	<Resistive load> Min. 10 ⁵ at rated switching capacity operating frequency: ON 1 s, OFF 9 s
		Lamp control type*4	<Resistive and capacitor loads> Min. 10 ⁵ at 70 A (inrush), 15 A (steady), 14 V DC operating frequency: ON 0.15 s, OFF 4.85 s
Conditions	Conditions for usage, transport and storage*3	Ambient temperature: -40 to +110°C Humidity: 2 to 85% RH (Avoid icing and condensation)	
Unit weight		Approx. 5 g	

*1. Depends on connection conditions. Also, this does not guarantee repeated switching. We recommend that you confirm operation under actual conditions.

*2. This value can change due to the switching frequency, environmental conditions, and desired reliability level, therefore it is recommended to check this with the actual load.

*3. The upper operation ambient temperature limit is the maximum temperature that can satisfy the coil temperature rise value. For details, please refer to the "Automotive Relay Users Guide".

Please inquire our sales representative if you will be using the relay in a high temperature atmosphere (110°C).

*4. Part numbers for electric discharge lamp loads or any other lamp loads and for capacitor loads only consist of "ACTBPD**".

When using the lamp control type, connect N.O. to the "+ (plus)" side. Please inquire our sales representative for details.

REFERENCE DATA

1-1. Coil temperature rise (at room temperature)

Sample: ACTBPDH4, 3 pcs.
Carrying current: 0 A, 10 A, 20 A, 30 A
Ambient temperature: Room temperature

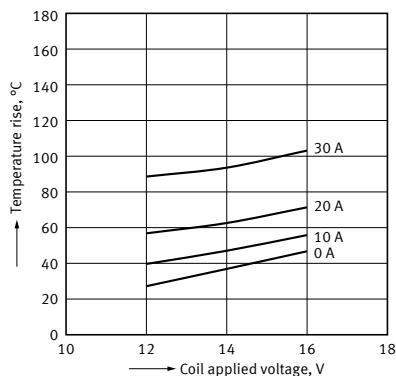

1-2. Coil temperature rise (at 110°C)

Sample: ACTBPDH4, 3 pcs.
Carrying current: 0 A, 10 A, 20 A
Ambient temperature: 110°C

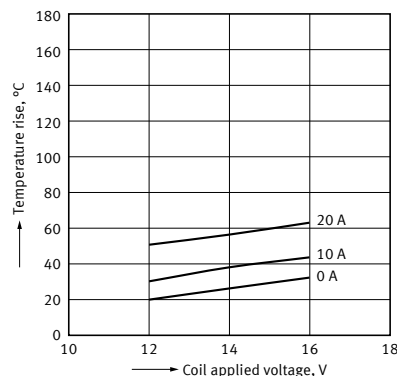

2. Ambient temperature and usable voltage range

Sample: ACTBPDH4

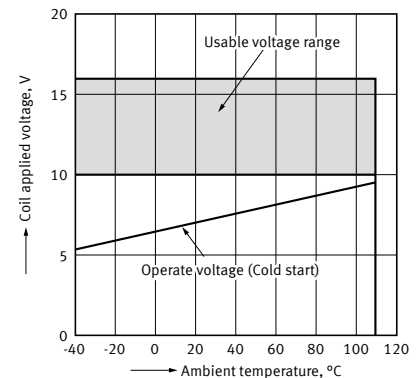

3. Distribution of operate (set) and release (reset) voltage

Sample: ACTBPDH4, 80 pcs.

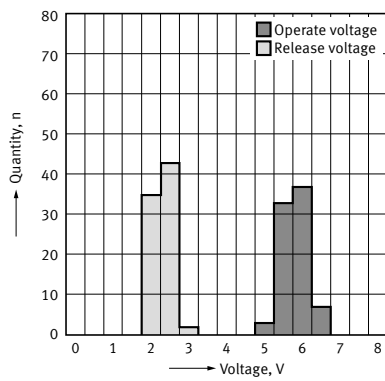

4. Distribution of operate (set) and release (reset) time

Sample: ACTBPDH4, 80 pcs.

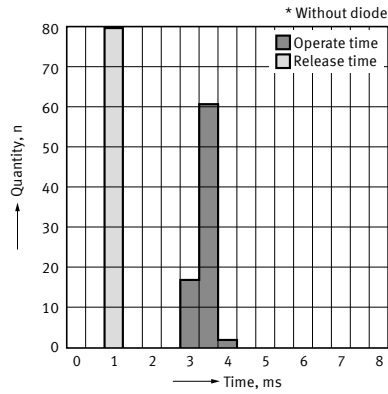

5. Electrical life test (Resistive and capacitor)

Sample: ACTBPDH4, 6 pcs.
 Load: Inrush current: 70 A, Steady current: 15 A 14 V DC
 Switching frequency: ON 0.15 s, OFF 4.85 s
 Ambient temperature: Room temperature
 Circuit:

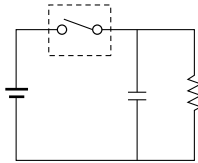

Change of operate (set) and release (reset) voltage

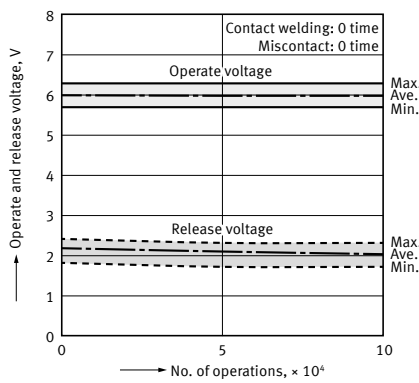

Change of contact resistance

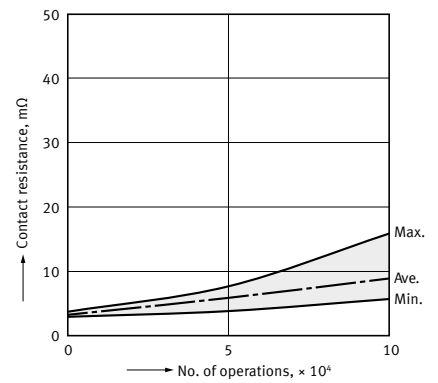

DIMENSIONS

CAD The CAD data of the products with a "CAD" mark can be downloaded from our Website.

Unit: mm

■ 1 Form A

● High heat resistant type

CAD



External dimensions

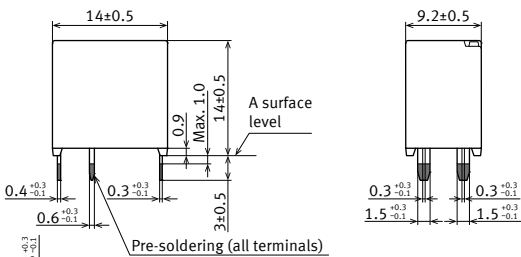

PC board pattern (BOTTOM VIEW)

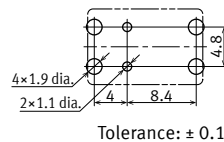

Schematic (BOTTOM VIEW)

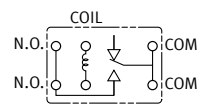

* The lamp control type has polarized contacts. Connect N.O. to the "+" (plus) side.

Tolerance
 Max. 1 mm : ± 0.1
 1 to 3 mm : ± 0.2
 Min. 3 mm : ± 0.3

* Dimensions (thickness and width) of terminal is measured after pre-soldering. Intervals between terminals is measured at A surface level.

Automotive Relays TB RELAYS POWER TYPE

● Pin in Paste compliant type

CAD



External dimensions

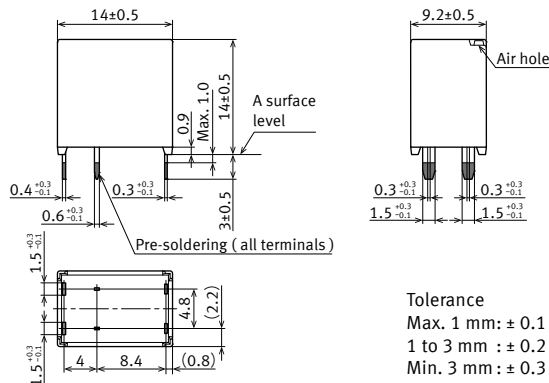

* Dimensions (thickness and width) of terminal is measured after pre-soldering.
 Intervals between terminals is measured at A surface level.

PC board pattern (BOTTOM VIEW)

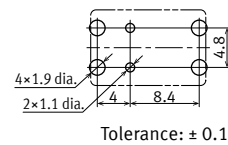

Schematic (BOTTOM VIEW)

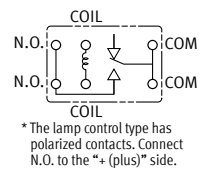

GUIDELINES FOR USAGE

■ For general cautions for use, please refer to the "Automotive Relay Users Guide".

■ Precautions when using TB relays power type

● Coil operating power

Pure DC current should be applied to the coil. If it includes ripple, the ripple factor should be less than 5%. However, check it with the actual circuit since the characteristics may be slightly different. Also, the power waveform should be rectangular.

● Coil applied voltage

To ensure proper operation, the voltage applied to the coil should be the rated operating voltage of the coil. Also, be aware that the pick-up and drop-out voltages will fluctuate depending on the ambient temperature and operating conditions.

● Expected life

Check this with the real device as it is affected by coil driving circuit, load type, activation frequency, activation phase, ambient conditions and other factors.

● Soldering

We recommend the relays, ensure conformance with the conditions listed tables.

1) Automatic soldering

Conditions	Preheating	Soldering
Temperature	100°C (surface of PC board)	260°C
Time	within 2 min	within 5 s

2) Manual soldering

Tip temperature	280 to 300°C
Soldering iron	30 to 60 W
Soldering time	within 5 s

● Atmosphere when using, storing and transporting

1) Ambient temperature, humidity and air pressure during usage and when storing or transporting

(1) Temperature

–40 to +85°C (Standard type)

–40 to +110°C (High heat resistant type)

(2) Humidity

2 to 85% RH

(Avoid icing and condensation)

(3) Air pressure

86 to 106 kPa

Note: The humidity range varies with the temperature. Use within the range indicated in the graph.

2) Water condensation

Water condensation occurs when the ambient temperature drops suddenly from a high temperature and humidity, or, the relay is suddenly transferred from a low ambient temperature to a high temperature and humidity. Condensation causes the failures like insulation deterioration, wire disconnection and rust etc. Panasonic Corporation does not guarantee the failures caused by condensation. The heat conduction by the equipment may accelerate the cooling of relay itself, and the condensation may occur. Please confirm no condensation in the worst condition of the actual usage. (Special attention should be paid when high temperature heating parts are close to the relay. Also, please consider the condensation may occur inside of the relay.)

3) Icing

Please check the icing when an ambient temperature is lower than 0°C. Icing means, the moisture contained in the surrounding environment and inside the relay freezes when the ambient temperature falls below the freezing point. The icing causes the sticking of movable portion, the operation delay and the contact conduction failure etc. Panasonic Corporation does not guarantee the failures caused by the icing. The heat conduction by the equipment may accelerate the cooling of relay itself and the icing may occur. Icing condition is changed by ambient environment, please make sure to confirm no icing in the worst condition of the actual usage.

4) Low-temperature, low humidity atmosphere

The plastic becomes brittle if the relay is exposed to a low temperature, low humidity environment for long periods of time.

[Temperature and humidity range for usage, transport, and storage]

[Standard type]

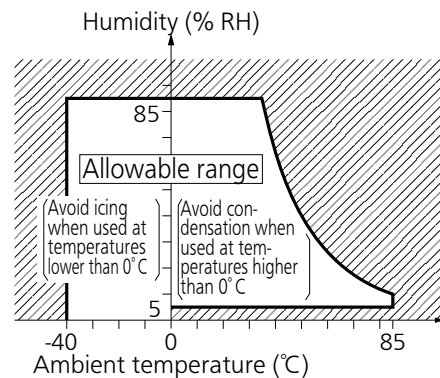

[High heat resistant type]

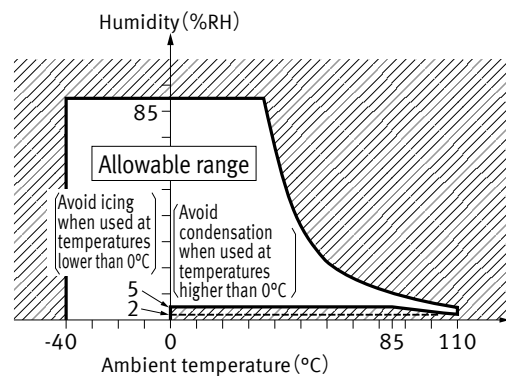

Automotive Relays TB RELAYS POWER TYPE

● Mounting and cleaning conditions for Pin in Paste compliant type

When soldering this relay, please observe the following conditions.

[I.R.S method (recommended)]

(Recommended number of reflows: 1 time)

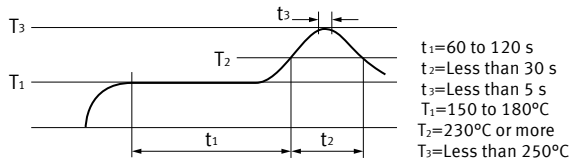

1) Cautions for mounting

- (1) The temperature profile shows the temperature at the soldering portion on the PC board surface.
- (2) Depending on the mounting density condition, reflow heating method, and PC board type (metal etc.), the relay's exterior and interior temperature may become extremely high. Therefore, please confirm well under the actual use condition before use.

2) The other cautions of reflow soldering

- (1) When soldering condition is out of recommendation, the relay performance may be adversely affected. If soldering conditions are out of our recommendation, please inquire our sales representative before operation.
- (2) Please check the effect at the actual soldering because heat stress to relay is changed by PC board type and manufacturing process condition.
- (3) Solder creepage, wettability or soldering strength will be affected by the mounting condition or soldering material. Please check the actual production condition in detail.
- (4) Do not wash the relay as failures may occur.
- (5) This product is not plastic sealed type. Please perform coating with sufficient attention to avoid infiltration of the solvent to the inside. Also, please pay careful attention to use and store them with no contamination of foreign material.

● Others handling precautions

Do not use relays that have been dropped, because doing so may be a cause of faulty operation.

Please refer to **"the latest product specifications"** when designing your product.

•Requests to customers:

<https://industrial.panasonic.com/ac/e/salespolicies/>

Please contact

Panasonic Corporation

Electromechanical Control Business Division

■1006, Oaza Kadoma, Kadoma-shi, Osaka 571-8506, Japan
industrial.panasonic.com/ac/e/

Panasonic[®]

©Panasonic Corporation 2021