

# Where Do I Find Everything I Need for Process Measurement and Control? OMEGA...Of Course!

## TEMPERATURE

- ☑ Thermocouple, RTD & Thermistor Probes, Connectors, Panels & Assemblies
- ☑ Wire: Thermocouple, RTD & Thermistor
- ☑ Calibrators & Ice Point References
- ☑ Recorders, Controllers & Process Monitors
- ☑ Infrared Pyrometers

## PRESSURE, STRAIN AND FORCE

- ☑ Transducers & Strain Gauges
- ☑ Load Cells & Pressure Gauges
- ☑ Displacement Transducers
- ☑ Instrumentation & Accessories

## FLOW/LEVEL

- ☑ Rotameters, Gas Mass Flowmeters & Flow Computers
- ☑ Air Velocity Indicators
- ☑ Turbine/Paddlewheel Systems
- ☑ Totalizers & Batch Controllers

## pH/CONDUCTIVITY

- ☑ pH Electrodes, Testers & Accessories
- ☑ Benchtop/Laboratory Meters
- ☑ Controllers, Calibrators, Simulators & Pumps
- ☑ Industrial pH & Conductivity Equipment

## DATA ACQUISITION

- ☑ Data Acquisition & Engineering Software
- ☑ Communications-Based Acquisition Systems
- ☑ Plug-in Cards for Apple, IBM & Compatibles
- ☑ Datalogging Systems
- ☑ Recorders, Printers & Plotters

## HEATERS

- ☑ Heating Cable
- ☑ Cartridge & Strip Heaters
- ☑ Immersion & Band Heaters
- ☑ Flexible Heaters
- ☑ Laboratory Heaters

## ENVIRONMENTAL MONITORING AND CONTROL

- ☑ Metering & Control Instrumentation
- ☑ Refractometers
- ☑ Pumps & Tubing
- ☑ Air, Soil & Water Monitors
- ☑ Industrial Water & Wastewater Treatment
- ☑ pH, Conductivity & Dissolved Oxygen Instruments

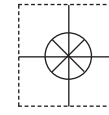

# User's Guide



An OMEGA Technologies Company

<http://www.omega.com>

e-mail: [info@omega.com](mailto:info@omega.com)

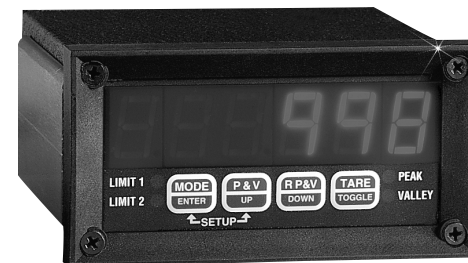

# DP7800 SERIES Dual Input Voltmeter



## WARRANTY/DISCLAIMER

OMEGAnet<sup>SM</sup> On-Line Service  
<http://www.omega.com>

Internet e-mail  
[info@omega.com](mailto:info@omega.com)

### Servicing North America:

**USA:** One Omega Drive, Box 4047  
Stamford, CT 06907-0047  
Tel: (203) 359-1660 FAX: (203) 359-7700  
e-mail: [info@omega.com](mailto:info@omega.com)

**Canada:** 976 Bergar  
Laval (Quebec) H7L 5A1  
Tel: (514) 856-6928 FAX: (514) 856-6886  
e-mail: [canada@omega.com](mailto:canada@omega.com)

### For immediate technical or application assistance:

**USA and Canada:** Sales Service: 1-800-826-6342 / 1-800-TC-OMEGA<sup>SM</sup>  
Customer Service: 1-800-622-2378 / 1-800-622-BEST<sup>SM</sup>  
Engineering Service: 1-800-872-9436 / 1-800-USA-WHEN<sup>SM</sup>  
TELEX: 996404 EASYLINK: 62968934 CABLE: OMEGA

**Mexico and Latin America:** Tel: (95) 800-TC-OMEGA<sup>SM</sup> FAX: (95) 203-359-7807  
En Español: (203) 359-7803 e-mail: [espanol@omega.com](mailto:espanol@omega.com)

### Servicing Europe:

**Benelux:** Postbus 8034, 1180 LA Amstelveen, The Netherlands  
Tel: (31) 20 6418405 FAX: (31) 20 6434643  
Toll Free in Benelux: 06 0993344  
e-mail: [nl@omega.com](mailto:nl@omega.com)

**Czech Republic:** ul. Rude armady 1868, 733 01 Karvina-Hranice, Czech Republic  
Tel: 420 (69) 6311627 FAX: 420 (69) 6311114  
e-mail: [czech@omega.com](mailto:czech@omega.com)

**France:** 9, rue Denis Papin, 78190 Trappes  
Tel: (33) 130-621-400 FAX: (33) 130-699-120  
Toll Free in France: 0800-4-06342  
e-mail: [france@omega.com](mailto:france@omega.com)

**Germany/Austria:** Daimlerstrasse 26, D-75392 Deckenpfronn, Germany  
Tel: 49 (07056) 3017 FAX: 49 (07056) 8540  
Toll Free in Germany: 0130 11 21 66  
e-mail: [germany@omega.com](mailto:germany@omega.com)

**United Kingdom:** 25 Swannington Road, P.O. Box 7, Omega Drive,  
Broughton Astley, Leicestershire, Irlam, Manchester,  
LE9 6TU, England M44 5EX, England  
Tel: 44 (1455) 285520 Tel: 44 (161) 777-6611  
FAX: 44 (1455) 283912 FAX: 44 (161) 777-6622  
Toll Free in England: 0800-488-488  
e-mail: [uk@omega.com](mailto:uk@omega.com)

OMEGA ENGINEERING, INC. warrants this unit to be free of defects in materials and workmanship for a period of **13 months** from date of purchase. OMEGA Warranty adds an additional one (1) month grace period to the normal **one (1) year product warranty** to cover handling and shipping time. This ensures that OMEGA's customers receive maximum coverage on each product.

If the unit should malfunction, it must be returned to the factory for evaluation. OMEGA's Customer Service Department will issue an Authorized Return (AR) number immediately upon phone or written request. Upon examination by OMEGA, if the unit is found to be defective it will be repaired or replaced at no charge. OMEGA's WARRANTY does not apply to defects resulting from any action of the purchaser, including but not limited to mishandling, improper interfacing, operation outside of design limits, improper repair, or unauthorized modification. This WARRANTY is VOID if the unit shows evidence of having been tampered with or shows evidence of being damaged as a result of excessive corrosion; or current, heat, moisture or vibration; improper specification; misapplication; misuse or other operating conditions outside of OMEGA's control. Components which wear are not warranted, including but not limited to contact points, fuses, and triacs.

**OMEGA is pleased to offer suggestions on the use of its various products. However, OMEGA neither assumes responsibility for any omissions or errors nor assumes liability for any damages that result from the use of its products in accordance with information provided by OMEGA, either verbal or written. OMEGA warrants only that the parts manufactured by it will be as specified and free of defects. OMEGA MAKES NO OTHER WARRANTIES OR REPRESENTATIONS OF ANY KIND WHATSOEVER, EXPRESSED OR IMPLIED, EXCEPT THAT OF TITLE, AND ALL IMPLIED WARRANTIES INCLUDING ANY WARRANTY OF MERCHANTABILITY AND FITNESS FOR A PARTICULAR PURPOSE ARE HEREBY DISCLAIMED. LIMITATION OF LIABILITY: The remedies of purchaser set forth herein are exclusive and the total liability of OMEGA with respect to this order, whether based on contract, warranty, negligence, indemnification, strict liability or otherwise, shall not exceed the purchase price of the component upon which liability is based. In no event shall OMEGA be liable for consequential, incidental or special damages.**

CONDITIONS: Equipment sold by OMEGA is not intended to be used, nor shall it be used: (1) as a "Basic Component" under 10 CFR 21 (NRC), used in or with any nuclear installation or activity; or (2) in medical applications or used on humans. Should any Product(s) be used in or with any nuclear installation or activity, medical application, used on humans, or misused in any way, OMEGA assumes no responsibility as set forth in our basic WARRANTY/DISCLAIMER language, and additionally, purchaser will indemnify OMEGA and hold OMEGA harmless from any liability or damage whatsoever arising out of the use of the Product(s) in such a manner.

## RETURN REQUESTS / INQUIRIES

Direct all warranty and repair requests/inquiries to the OMEGA Customer Service Department. BEFORE RETURNING ANY PRODUCT(S) TO OMEGA, PURCHASER MUST OBTAIN AN AUTHORIZED RETURN (AR) NUMBER FROM OMEGA'S CUSTOMER SERVICE DEPARTMENT (IN ORDER TO AVOID PROCESSING DELAYS). The assigned AR number should then be marked on the outside of the return package and on any correspondence.

The purchaser is responsible for shipping charges, freight, insurance and proper packaging to prevent breakage in transit.

FOR **WARRANTY** RETURNS, please have the following information available BEFORE contacting OMEGA:

1. P.O. number under which the product was PURCHASED,
2. Model and serial number of the product under warranty, and
3. Repair instructions and/or specific problems relative to the product.

FOR **NON-WARRANTY** REPAIRS, consult OMEGA for current repair charges. Have the following information available BEFORE contacting OMEGA:

1. P.O. number to cover the COST of the repair,
2. Model and serial number of product, and
3. Repair instructions and/or specific problems relative to the product.

OMEGA's policy is to make running changes, not model changes, whenever an improvement is possible. This affords our customers the latest in technology and engineering.

OMEGA is a registered trademark of OMEGA ENGINEERING, INC.

© Copyright 1996 OMEGA ENGINEERING, INC. All rights reserved. This document may not be copied, photocopied, reproduced, translated, or reduced to any electronic medium or machine-readable form, in whole or in part, without prior written consent of OMEGA ENGINEERING, INC.

It is the policy of OMEGA to comply with all worldwide safety and EMC/EMI regulations that apply. OMEGA is constantly pursuing certification of its products to the European New Approach Directives. OMEGA will add the CE mark to every appropriate device upon certification.

The information contained in this document is believed to be correct but OMEGA Engineering, Inc. accepts no liability for any errors it contains, and reserves the right to alter specifications without notice.

**WARNING:** These products are not designed for use in, and should not be used for, patient connected applications.

## TABLE OF CONTENTS

SPECIFICATIONS .....	1
DESCRIPTION .....	3
SWITCH FUNCTIONS .....	4
LED INDICATORS .....	4
SETUP .....	5
Peak & Valley .....	5
Decimal Point Position .....	5
Tare Setting .....	5
Set Display Zero .....	5
Set Display Span .....	6
Analog Output Setup .....	6
Set Analog Output Span .....	6
Limit Setup .....	6
Guardband Setup .....	7
Baud Rate Selection .....	7
Unit Address Setup .....	7
Echo and Line Feed Setup .....	7
Continuos Update Setup .....	8
Legend Setup .....	8
Serial Command Setup .....	8
CALIBRATION .....	9
Protection Code .....	9
Zero Point Calibration Programming .....	9
New Protection Code Programming .....	9

SERIAL COMMUNICATIONS .....	10
Echo .....	11
Line Feed .....	11
Address Enable .....	11
Address Disable .....	11
Read Display .....	12
Set Limit .....	12
Verify Limit .....	12
Reset Peak .....	12
Reset Valley .....	12
Remote Tare .....	12
Test Message .....	12
Continuous Reading .....	13
Set Legend .....	13
Remote Serial Command .....	13
Decimal Position .....	13
Reading Mode .....	14
FIGURE 1.0 (DP7800 Back View) .....	15
FIGURE 2.0 (DP7800 Input Connections) .....	16
FIGURE 3.0 (DP7800 Dual Channel Input Connections) .....	15
SCALING .....	17
SCHEMATIC (DP7800 Analog Board) .....	18
SCHEMATIC (DP7800 Display Board) .....	19
DIMENSIONS .....	20
MOUNTING & WARRANTY .....	20

## DIMENSIONS

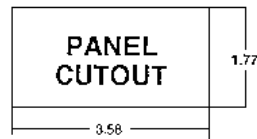
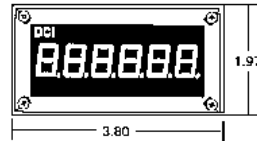
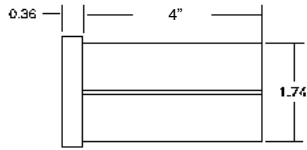

## MOUNTING

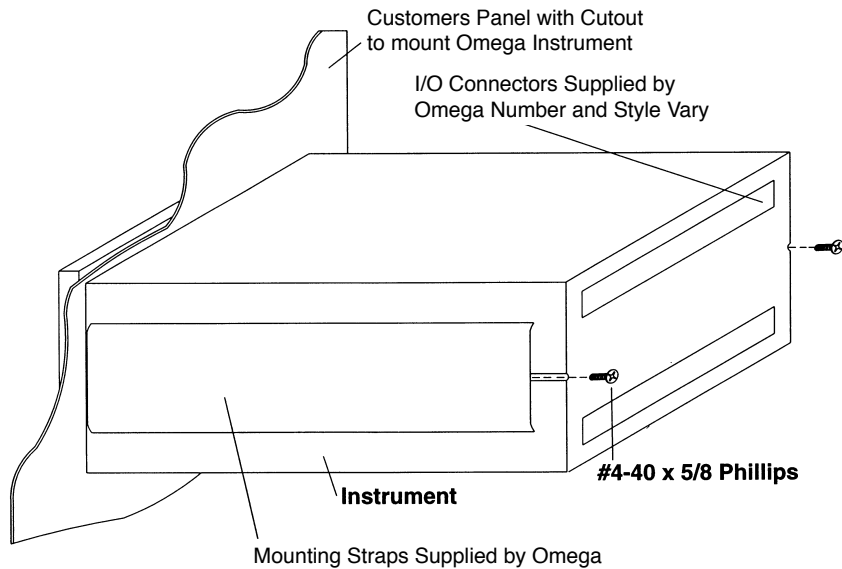

**Note: Use Corner Screw of Case for Case Ground**

## SPECIFICATIONS:

### **Power Requirements:**

- AC: 105VAC to 132VAC @ 50mA (47Hz to 500Hz)
- AC: 198VAC to 264VAC @ 25mA (47Hz to 500Hz) optional.

### **Accuracy:**

- $\pm .01\%$  or reading  $\pm 1$  count of LSD.

### **Display:**

- Type: Five digit, seven segment LED 0.56" (14.3mm) high.
- Polarity Indication: "-" Displayed
- Overrange Indication: "Or" Displayed
- Span programmable from  $\pm 1000$  to  $\pm 30,000$  counts.
- Digital zero (tare) 50% of span.
- All setup parameters stored in nonvolatile memory during power outage.

### **Limit Outputs:**

- Two form "A" relay closures rated .25A at 28V.

### **Environmental:**

- Operating Temperature Range:  $-20^{\circ}\text{C}$  to  $+60^{\circ}\text{C}$
- Storage Temperature Range:  $-25^{\circ}\text{C}$  to  $+85^{\circ}\text{C}$
- Relative Humidity: 0% to 90%, Non-condensing

### **Dimensions:**

- Case size "D" Refer to page 18.
- Weight: 1 pound
- I/O Terminations: Fifteen quick disconnect terminals.

### **Analog to Digital Conversions:**

- Technique: 16 Bit Sigma Delta
- Rate: 3 Conversions/Second (DP7800)

## Analog Output (optional):

- Voltage: 0-10V, 2.5mV resolution. 0V and 10V points are programmable via front panel switches.
- Maximum drive capability  $\pm 2\text{mA}$ .
- CMV: 1400V Peak (AC or DC) between analog output, ground and AC power line to ground.
- 4-20mA output, maximum load  $600\Omega$ . The 4mA and the 20mA points are programmable via front panel switches.

## Serial Interface (optional):

- ASCII RS-232 or RS485 compatible (optional); format: 1 start bit, 8 data bits, 1 stop bit, and no parity bits. Baud Rates: 9600, 4800, 2400, 1200, 600, 150, & 75 programmable from the front panel.

## Range Programming:

- Solderless jumpers on rear of unit 0 to  $\pm 200\text{mV}$ ,  $\pm 2\text{V}$ ,  $\pm 20\text{V}$ ,  $\pm 200\text{V}$ , and 4-20mA. When option 20 is selected ranges are 0-5V, 1-5V, or 4-20mA.

## OPTIONS

- -S2 RS232 Compatible Interface
- -S4 RS485 Compatible Interface
- -DC5 +5VDC input power 600mA max
- -AMA 4-20mA output max load  $600\Omega$
- -A10 Analog output, (0-10VDC) tracks input
- -DC 9/18 9-18VDC power @ 600mA
- -DC 18/36 18-36VDC power @ 500mA
- -230VAC 230VAC; 50Hz - 400Hz input power
- -LED Sunlight Readable Red LED

## DP7800 DIGITAL DISPLAY BOARD

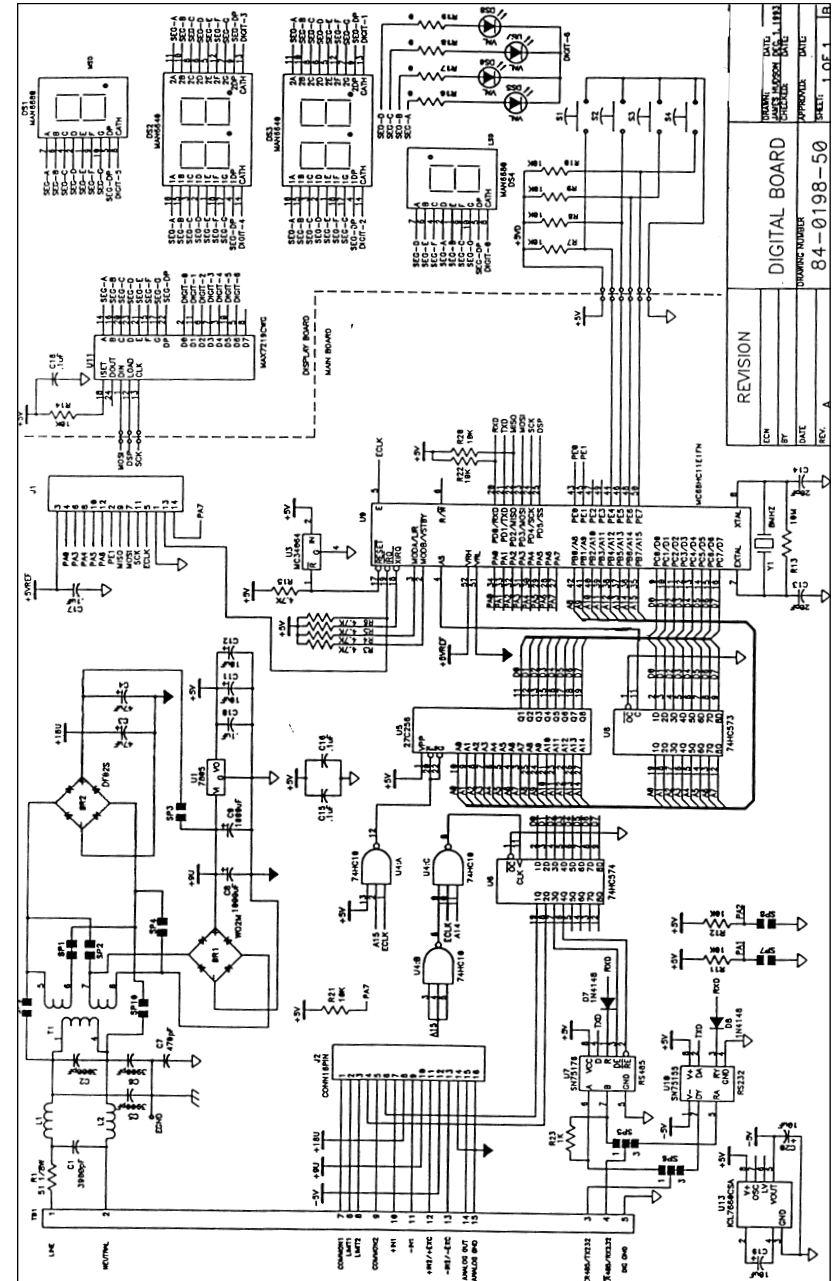

# DP7800 VOLTMETER ANALOG BOARD

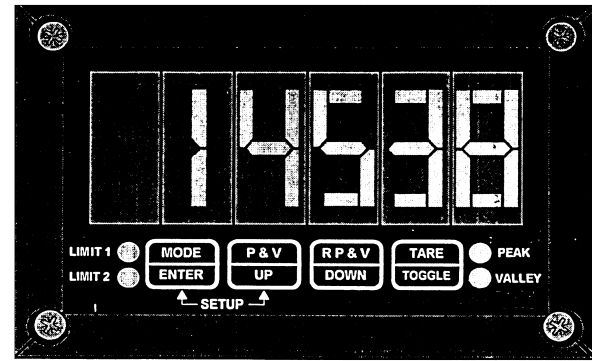
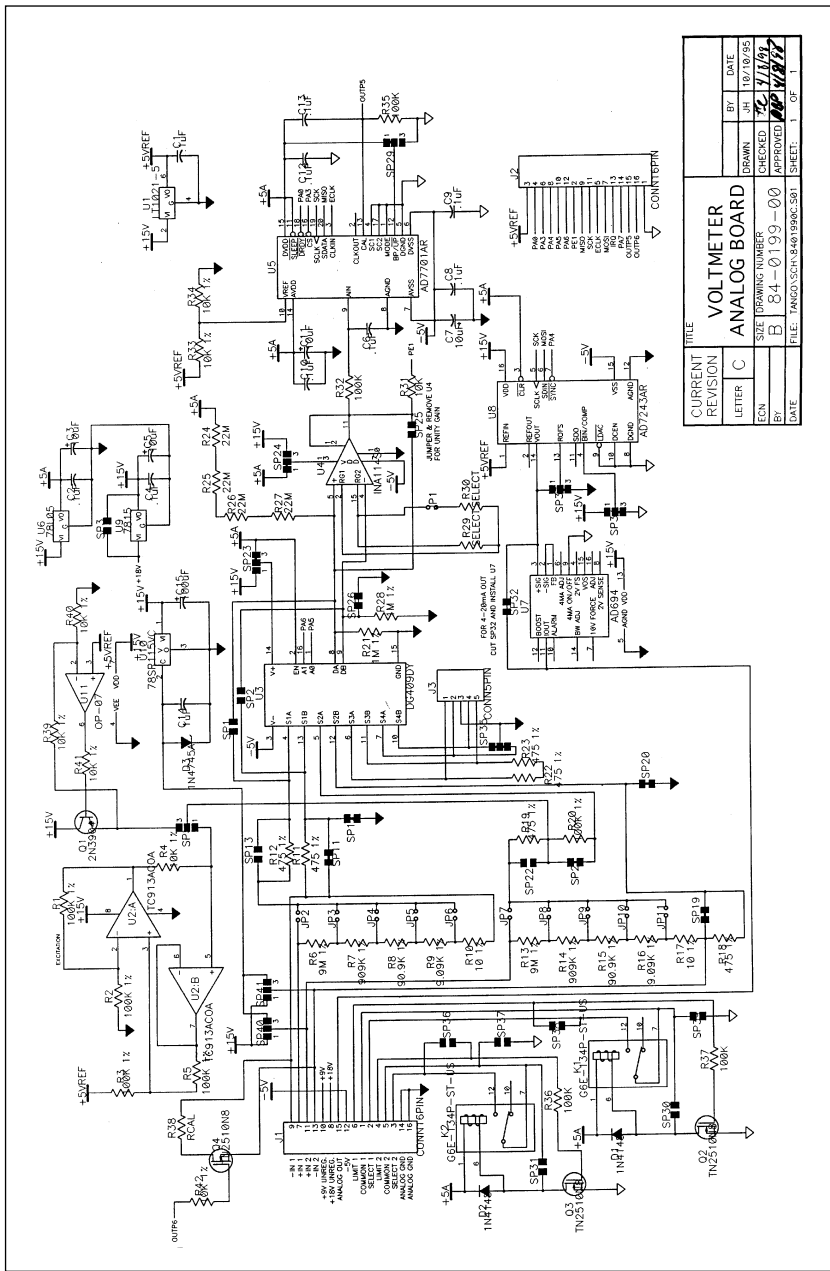

## DESCRIPTION:

The DP7800 is a new generation short depth 1/8 DIN package, microprocessor based digital readout that is easily programmable via the four front panel switches. Zero offset of up to 50% of span is easily accomplished using a single front panel pushbutton. Engineering units scaling is done using a microprocessor and the sixteen bit analog to digital converter. The unit will accept two voltage inputs simultaneously and perform math functions on the two inputs with alarm relay outputs. Available math functions are A - B, A + B, A x B, A ÷ B, and  $y = mx + B$ .

Optional analog outputs of 0 - 10VDC or 4 - 20mA are available and the high and low points of these outputs can be programmed via the front panel switches or even inverted ie: 20 - 4mA. Peak and valley detect with memory and reset are standard on the unit. RS232 and RS485 interface options are available to interface to computers, PLC's or printers. Bezel and scratch resistant lens are sealed to meet the requirements of NEMA 4 and supplied with gasket to seal unit to panel.

## SWITCH FUNCTIONS:

On the front of the DP7800 will be four switches that are placed behind the front lens. Each switch is labeled from left to right as Mode [Enter], P&V[Up], RP&V[Down], and Tare[Toggle]. A description of each switch function is as follows.

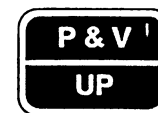

## SWITCH FUNCTIONS:



### *Data Acquisition & Display*

Press to set the display mode for a actual reading and channel indication.

### *Setup & Calibration Modes*

Press to record a complete setting and advance to the next setup.

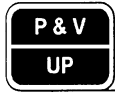

### *Data Acquisition & Display*

Press to set the display mode for peak, valley, and back to the original mode.

### *Setup & Calibration Modes*

Press to increment the digit/parameter being set.



### *Data Acquisition & Display*

Press to reset the peak or valley.

### *Setup & Calibration Modes*

Press to decrement the digit/parameter being set.



### *Data Acquisition & Display*

Press to record the current reading as the tare value. Hold for a approximately two seconds, to set display tare.

### *Setup & Calibration Modes*

Press to advance to the next digit to be set.

## LED INDICATORS:



Illuminates when the display reading exceeds the set high limit.



Illuminates when the display reading is below the set low limit.



Illuminates when the display is set to peak mode.



Illuminates when the display is set to valley mode.

## SCALING

On the rear of the meter you will find some jumpers labeled JP1-JP11. These jumpers are used to set the input voltage settings for channel 1 and channel two inputs. To make these jumpers follow the table below.

Note that JP2-JP6 set the input for channel 1 and JP7-JP11 set the input for channel 2. When setting the jumpers for channel 1 and channel 2 only jumper the one that is called out.

Note that JP1 is not normally used.

### Channel 1:

• 200mV	Jumper JP2
• 2V	Jumper JP3
• 20V	Jumper JP4
• 200V	Jumper JP5
4-20mA	Jumper JP2 and JP6

### Channel 2:

• 200mV	Jumper JP7
• 2V	Jumper JP8
• 20V	Jumper JP9
• 200V	Jumper JP10
4-20mA	Jumper JP7 and JP11

It may be necessary to recalibrate each channel when changing these jumpers.



## TRANSDUCER TO TB1

**FIGURE 2.0**

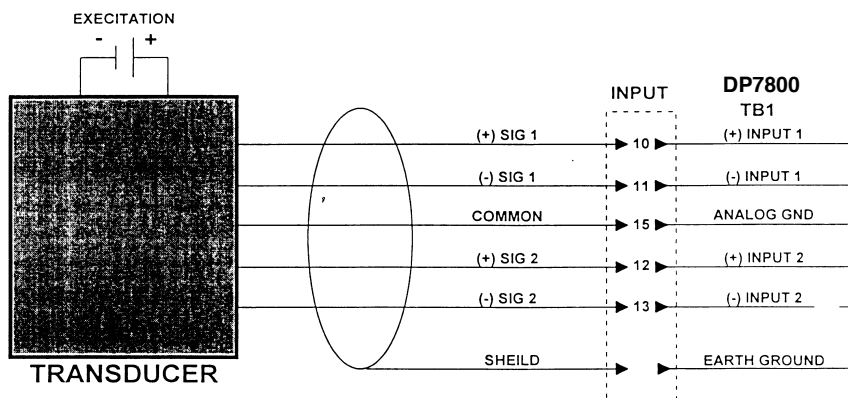

### DP7800 CONNECTIONS

#### TB1

1. +115VAC
2. -115VAC
3. RS-232 Transmit/RS-485
4. RS-232 Receiver/RS-485
5. Digital Ground
6. Limit One Normally-Open
7. Limit One Common
8. Limit Two Normally-Open
9. Limit Two Common
10. Channel One Input +
11. Channel One Input -
12. Channel 2 Input +
13. Channel 2 Input -
14. Analog Output
15. Analog Ground

NOTE: This unit should be tied to earth ground for proper line power filtering and safety precautions.

NOTE: Standard Input Power is 115VAC (Optional power is listed below).

Option - DC9/18

Option - DC18/36

Option DC Input Power is Pin 1 (-) Pin 2 (+)

### SETUP:

Your meter setup is accomplished by using the four front panel switches. The setup mode is entered by pressing the Mode[Enter] and P&V[Up] switches simultaneously. At this point we will examine how to perform the setup procedures.

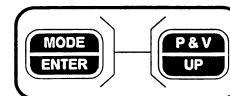

NOTE: If not pressed simultaneously the unit may go into peak/valley mode upon exiting the setup mode. The peak/valley LED will be illuminated and the peak/valley reading will be displayed.

#### *Peak & Valley:*

Upon entering the setup mode the peak and valley setup displays **PH VL**. To activate the peak use the P&V[Up] switch which will toggle the peak(PH) on and off, with the "1" being on and the "0" being off. For the valley(uL) use the RP&V[Down] switch operate the same way. Press the Mode[Enter] switch to proceed with the setup.

#### *Decimal Point Position:*

**dP** Program the desired decimal point position using the Tare[Toggle] switch to move the decimal point. Press Mode[Enter] when done.

#### *Tare Setting:*

**TARE** The tare command is used to remove tare (set tare value to zero). The tare switch will not remove the tare value when unit is in the standard operating mode.

#### *Set Display Zero:*

**CH 0** To setup the display zero, the number is what the display will read when the voltage at the input is the same as zero, calibration is on page 10. This can be any positive number up to 30,000. To change this number, follow this procedure. P&V[Up] increments the number and RP&V[Down] decrements the number. Switch Tare[Toggle] increases the multiplier that the number is incremented or decremented by. Upon entering any setup function the multiplier defaults to 1. At each press of Tare[Toggle] the multiplier increases by a factor of 10. For example: 1, 10, 100, 1000, 10000, 100000. To enter this number and go to the next setup option press Mode[Enter].

## DP7800 BACK VIEW

### *Set Display Span:*

**CH1 SP** Momentarily, this is what is displayed, then a number will appear on the display. This number is what the display will read when the voltage is at the input voltage calibrated for full scale. This can be any positive number up to 30,000. To change this number follow the same procedure as outlined above. To enter this number and go to the next setup option press Mode[Enter]. The next setup option is setting of the channel 2, zero and span values. The above procedure for setting the values for channel one is repeated for channel two.

### *Analog Output Setup:*

**AO SP** If the analog output option has been installed this message will be displayed after the span setup. This number is what the display reads when the analog output is at zero volts or 4mA. This can be any number over the range of displayable reading inputs. To change this number follow the switch functions on page 3. Upon entering any setup function the multiplier defaults to 1. At each press of Tare[Toggle] the multiplier increases by a factor of 1. For example: 1, 10, 100, 1000, 10000, 100000, 1. Enter the number and proceed to the next setup by Mode[Enter].

### *Set Analog Output Span:*

**AO SP** This is the analog span that is part of the analog output option. This number is what the display reads when the analog output is at ten volts or 20mA. This can be any number over the range of displayable readings inputs. To change this number, follow the same procedure as outlined above. Enter the number and this concludes the analog setup. Enter the next setup.

### *Limit Setup:*

**LIMIT** Indicates the limit setup function that deals with the limit values and other parameters. After coming to the limit functions the display will change after about one second and a number will be indicated. This number is the limit 1 setting. This setting can be changed using the same procedure as outlined above in the display zero function. After setting this number press Mode[Enter] switch it will advance to the next limit function. The next function sets whether the limit activates above the limit or below the limit. The unit then displays

**LIMIT** where “H” which activates the limit above the display reading or “L” which activates the limit below the display reading. To change the above or below activation setting, press the RP&V[Up] switch. After setting these parameters press Mode[Enter] switch and this will be repeated for the second limit. After setting the second limit parameters pressing Mode[Enter]. The above two functions will be repeated for the second limit. After setting the second limit parameters pressing Mode[Enter] and the instrument will advance to the next setup function.

**FIGURE 1.0**  
**DP7800 DUAL CHANNEL INPUT CONNECTIONS**

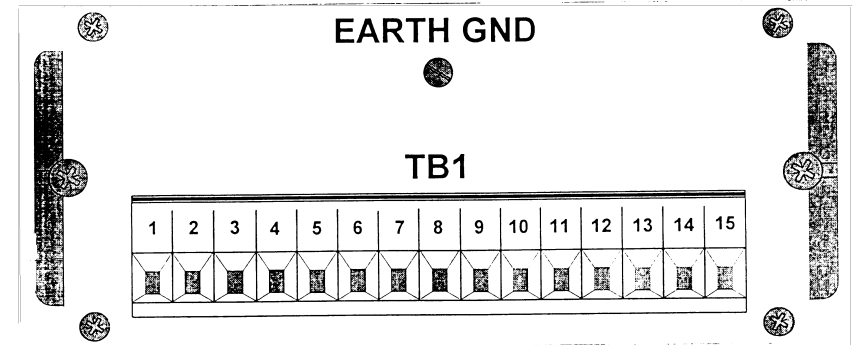

X=0: No decimal point  
 X=1: YYYY.Y  
 X=2: YYY.YY  
 X=3: YY.YYY  
 X=4: Y.YYYY  
 X=5: .YYYYY

READING MODE: [PVXc.r.]

The reading mode command is used to set the display and serial interface reading modes (i.e., reading, peak, or valley). The attached number (X) has a range from 0 to 6 with each value representing a particular combination of displays and serial reading modes. The list of combinations follows:

X = 0: Display = reading, Serial = reading  
 X = 1: Display = peak, Serial = reading  
 X = 2: Display = reading, Serial = peak  
 X = 3: Display = Peak, Serial = Peak  
 X = 4: Display = valley, Serial = reading  
 X = 5: Display = reading, Serial = valley  
 X = 6: Display = valley, Serial =valley

#### Guardband Setup:



The next setup function will allow control over the limit settings for control applications. The three digit number is the guardband setting in degrees. The guardband setting will allow the reading to fall within a window before limit activation occurs. For Example: If the limit were set at 500, the guardband set at 5, and the limit activates as a high limit. If the reading were 490 the limit would be off, if the reading were 501 the limit would be on, if the limit were on and the readings starts to fall the limit would not turn off until the reading falls below 495. This feature is useful when using a heater to control the temperature of a liquid. To change the guardband setting, pressing P&V[Up] will increment the number by one, and pressing RP&V[Down] will decrement the number by one. After setting the guardband pressing Mode[Enter] will advance to the next setup function.

NOTE: See the serial communications section on page 11 for more information on the following setups. Note that the baud rate setup, unit address setup, echo line feed, continuous update, and the serial command setups apply only if you have options one or two installed on the instrument.

#### Baud Rate Selection:



Program the desired baud rate using the P&V[Up] or RP&V[Down] and toggle through the available settings (9600, 4800, 2400, 1200, 600, 300, 150, and 75). Select a desired setting and press Mode[Enter] when done.

#### Unit Address Setup:

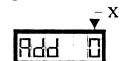

The address enable and disable commands can be used when a series of DP7800's are connected together on the same serial bus. The address enable command allows the unit specified by the address number XXX to be enabled. The address used must be in the range of 0 to 255. To program the unit's address (0 to 255) using the P&V[Up] and RP&V[Down] switches. Press Mode[Enter] when done.

#### Echo and Line Feed Setup:



The echo command is used to turn the auto echo function on or off. When on, the unit automatically re-transmits all received serial data. When the selected value X is a one the echo function is turned on, conversely when X is zero the echo function is turned off.

The line feed command is used to turn the line feed function on or off. When the line feed is on the unit will follow every message with a line feed character. When the selected value is a one the line feed character is transmitted, conversely when X is zero the line feed character is not transmitted. To turn the line feed option on/off use the RP&V[Down] Switch. Press Mode[Enter] when done.

### Continuous Update Setup:

cr 257

The continuous reading command allows an auto serial update mode to be selected. A value of -1 will output data once for every conversion (3 times per second). A value of one or greater will indicate the number of seconds between updates, up to the maximum of 3600 seconds between updates. The value of zero will disable the auto update function. To program the continuous update setting (-1-3600) using the P&V[Up], RP&V[Down] switches to move in either direction. The Tare[Toggle] switch sets the increment that you choose to move in. Press Mode[Enter] when done.

Legend Setup:

l9 4

The legend setup command allows the selection of a unit to define the transmitted reading. Use the P&V[Up], RP&V[Down] switches to select a legend number from the legend table below. Press Mode[Enter] when done.

Legend Table

1. - LBS	6. - F.	11. - KOhms	16. - RPM	21. - Hz
2. - TEMP	7. - Mv	12. - Mohms	17. - FPM	22. - VAC
3. - C	8. - V	13. - PSI	18. - GPM	23. - mRADS
4. - C.	9. - A	14. - PSIA	19. - MPH	
5. - F	10. - Ohms	15. - PSIG	20. - IPM	

### Serial Command Setup:

dc r 5

Remote serial command is most widely used if several units are connected together in series to the same printer. A device code allows the units to “take turns” on a serial bus. When two or more units are connected serially and set for the same bus, the first unit in the string can have its device code enabled. All units should have the echo function enabled in order to pass messages along in the string. When the serial command is sent a value (XYY) the first attached number (YY) is the corresponding number for the remote serial command. A table of these numbers can be found in the serial communication section on Page 11. Use the P&V[Up] switch to select the device code. Press Mode[Enter] when done.

danE

### CONTINUOUS READING: [CFXXXXc.r.]

The continuous reading command allows the auto serial update mode to be selected. It updates all the units with corresponding display data at the selected time interval. The attached number (XXXX) is the numeric value from -1 to 3600. A value of 0 will disable the auto update function. A value of -1 will output data once for every conversion (2.5 times per second). A value of one or greater indicates the number of seconds between updates up to maximum of 3600 seconds between updates.

### SET LEGEND: [LRX c.r.]

The set legend command allows the selection of a unit indicator, which will be added onto reading update from the serial output. The number (X) applied to the command indicated which unit form the legend table ( on page 9) will be appended to the serial reading.

### REMOTE SERIAL COMMAND: [SCXYyc.r.]

For data logging purposes, certain concessions must be made if several units are connected together to the same printer. If the units are connected serially and set for the same auto update time, contention could result in scrambled data at the printer. A device code allows the units to “take turns” on the serial bus. When two or more units are connected to the same bus, the first unit in the string can have its device code enabled. The unit will then send a printable character at the end of its message string. The next unit will suppress this character and perform a serial command specified in the remote serial command setup (for example a RD command). The second unit may also have the device code enabled and so on. All units should have the echo function enabled in order to pass messages along in the string.

When the SC command is sent a value of zero for the first attached number (X) disables the device code, conversely a one enables the device code. The second attached number (YY) is the corresponding number for the remote serial command. These numbers can be found in the serial communications section in the table on page 11.

### DECIMAL POSITION: [DPXc.r.]

The decimal position command allows programming a decimal point position for the display and serial communication readings. The attached number (X) can have a range of 0 to 5 the table below shows the each value and its corresponding effect on the decimal point position.

#### READ DISPLAY: [Rdc.r]

When the read display command is received the unit will return either the current reading, the current peak reading or the current valley reading, depending on the serial reading mode selected by the reading mode command (see below). The return data format will be [sXXXX.Xc.r.] where (s) is the minus sign (if needed), (XXXX) is the reading, and (.) is the decimal point (if needed).

#### SET LIMIT: [S#XXXXXc.r.]

The set limit command is used to program a limit number for the high or low limit. The first number following the command (#) specifies whether the high limit or low limit is being programmed. A one in this field specifies the high limit, while a two specifies the low limit. The number following this (XXXXX) is the actual limit number to be entered.

#### VERIFY LIMIT: [VXc.r.]

The verify limit command is used to read the current high and low limit settings for the unit. The applied number (X) specifies whether the high or low limit value is to be returned. A one specifies the high limit, while a two specifies the low limit.

#### RESET PEAK: [Spc.r.]

The reset peak command performs a remote reset to the peak reading.

#### RESET VALLEY: [Svc.r.]

The reset valley command performs a remote reset to the valley reading.

#### REMOTE TARE: [SZXc.r.]

The remote tare command is used to perform a tare function comparable to the panel tare switch. When the command is received with a number (X) attached, the tare value is set or cleared depending on whether the unit was already tared or not. When the command is received without a number attached the current tare value is returned.

#### TEST MESSAGE: [TMc.r.]

The test message command is diagnostic aid. When the test message command is received the unit will output all current settings, readings and the model number with software revision.

#### CALIBRATION:

The calibration mode is entered by pressing RP&V[Down] and Tare[Toggle] switches simultaneously. Note: This is the only method to check or change the calibration of this unit externally.

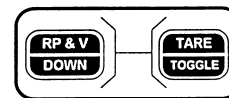

Note: Do not enter the calibration mode unless you have an appropriate signal sources for zero and span calibration.

#### Protection Code:

code

Before any calibration can be performed on the unit a unique security code must be entered. If the code is not entered correctly the unit will automatically revert to display and acquisition mode; otherwise, the user is allowed to proceed with the calibration sequence. To enter the code use the P&V[Up] or the RP&V[Down] switches to set the code any were from (0-99). The unit is normally shipped from the factory with a protection code of "10" programmed.

cALAdc

Display's the introduction to the calibration of the A/D Converter.

52 0

For one count the present zero point is displayed, for the next count the present span calibration will display.

53 F5

#### Zero Point Calibration Programming:

52or53

This is to show that a new zero point and span is ready to be set. To continue depress the P&V[Up] switch, that will display channel one and enable your zero (null) point. Set the transducer or calibrator for zero output, allow sufficient time for the reading to stabilize, then press the P&V[Up] switch to store the new zero calibration data. Next set the transducer or calibrator for a full-scale output, allow sufficient time for the reading to stabilize. Then press the RP&V[Down] switch to store the new span calibration. Press the Mode[Enter] switch to move to the next step.

#### New Protection Code Programming:

code

A different protection code can be programmed at this time. The code can be anywhere in the range 0-99. If a new code is not required simply press Mode[Enter]. The calibration sequence is now ended. Allow the instrument to stabilize approximately 5 seconds.

EndcAL

## SERIAL COMMUNICATIONS:

If the serial communications option is installed it allows the DP7800 series to communicate with a remote computer, terminal or printer. Two standard serial options are available RS-232 or RS-485. Almost all functions available from the front panel switches can be duplicated by the host computer. Listed below are all commands with their associated remote serial command number. Later in this section a full description is given for each command.

1	EH	Set Echo Mode
2	LF	Set Line Feed Mode
3	AE	Address Enable
4	AD	Address Disable
5	RD	Read Display
6		NOT USED
7		NOT USED
8	S1	Set Limit One (high limit)
9	S2	Set Limit Two (low limit)
10		NOT USED
11		NOT USED
12	SP	Peak Reset
13	SV	Valley Reset
14	SZ	Remote Tare
15		NOT USED
16		NOT USED
17		NOT USED
18		NOT USED
19	TM	Test Message
20		NOT USED
21		NOT USED
22	CR	Set Continuous Reading Mode
23		NOT USED
24		NOT USED
25		NOT USED
26	LR	Set Legend
27	SC	Remote Serial Command
28	DP	Set Decimal Point Position
29		NOT USED
34		NOT USED
35	PV	Set Display, Serial Reading Modes

Serial data is transmitted/received as ASCII characters, using the selected baud rate, each word or character is made up of eight data bits, one stop bit and no parity bit. The format of data transmitted depends on the command. The left most character is transmitted or received first and terminated with a carriage return (c.r.). When additional digits are required, the leading zeros or place holders may be omitted. A plus

sign is optional but if used, it must proceed the numbers. Any received numbers will have the decimal point ignored. Transmitted numbers will have a decimal point (when needed) to conform with the display format. In the command descriptions below the command string will be shown within brackets ([ ]), the sign if required will be shown as a lower case (s), and the number as upper case (X). Commands that are used to set a parameter can be sent to the unit without that parameter attached. The unit will respond with the current setting for that parameter. This allows the verification of parameter settings. Once a valid command is received and executed, the unit responds by transmitting [Okc.r.] on the serial bus. The following is a list of all serial commands with a description of their meaning, along with programming instructions.

ECHO: [EHXc.r.]

The echo command is used to turn the auto echo function on or off. When the echo is on, the unit automatically re-transmits all received serial data. When the applied value X is a one the echo function is turned on, conversely when X is zero, the echo function is turned off.

LINE FEED: [LFXc.r.]

The line feed command is used to turn the line feed on or off. When the line feed is on the unit will follow every message with a line feed character. When the applied value X is a one the line feed character is transmitted, conversely when X is zero the line feed character is not transmitted.

ADDRESS ENABLE: [AEXXXc.r.]

The address enable and disable commands can be used when a series of units are connected together on the same serial bus, (i.e. a RS-485 serial interface where several units are in parallel on a serial bus or an RS-232 serial interface where several units are connected in series). The address enable command allows the unit specified by the address number XXX to be enabled. The address used must be in the range of 0 to 255. When the unit address is set to 0, the unit will respond to commands without first receiving the address enable command. When enabled with the address enable command the unit will respond with [HELLOc.r.]

ADDRESS DISABLE: [ADXXXc.r.],[Adc.r.]

This command allows the unit specified by the address number XXX to be turned off or disabled. The address must be in the range of 1 to 255. If an address is not supplied with the command all units on the serial bus will be turned off or disabled. If the unit is disabled by the unit address number the unit will respond with [BYEc.r.].