

# XC9282B33E0R-G Evaluation Board User Manual

**5.5V/0.6A Step-down DC/DC Converter with HiSAT-COT Control**

## **CAUTION**

### **ENGINEERING EVALUATION PURPOSES ONLY**

This evaluation board is made for the purpose of the product evaluation. It is strictly prohibited to use this evaluation board for any other purpose.

Torex Semiconductor does not guarantee that all samples will perform in exactly the same way and we recommend that you always consult our product data sheets for the minimum and maximum specifications.

It is also important that you evaluate all our products carefully before mass

**XC9282B33E0R-G Evaluation Board**

*HiSAT-COT Control, 0.6A Synchronous Step-Down DC/DC Converters*

**Evaluation Board Picture**

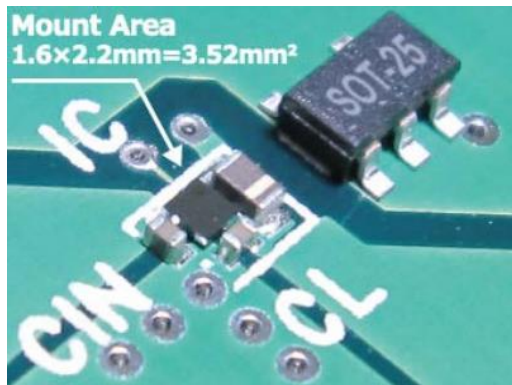

**Evaluation Board SPEC**

						Ta=25°C
		CONDITON.	MIN.	TYP.	MAX.	UNIT
Vin	Input Voltage Range	-	2.5	-	5.5	V
Vout	Setting Output Voltage	-	-	3.3	-	V
Iout	Output Current	-	0	-	600	mA
fosc	Switching frequency	-	-	6.0	-	MHz

**XC9281/XC9282 Series Features**

- Input Voltage Range ..... 2.5V ~ 5.5V
- Output Voltage Range ..... 0.7V ~ 3.6V (step 0.05V)
- Max Output Current ..... 600mA max.
- Switching frequency ..... 4MHz or 6MHz
- Max Duty Cycle ..... 100%
- Small Solution Size ..... 3.52 mm<sup>2</sup>
  
- Fast Load Transient Response
- 0.6 x 0.3mm Ceramic Cap. Available
- Low EMI Noise

# XC9282B33E0R-G Evaluation Board

HiSAT-COT Control, 0.6A Synchronous Step-Down DC/DC Converters

## Quick Start Procedure

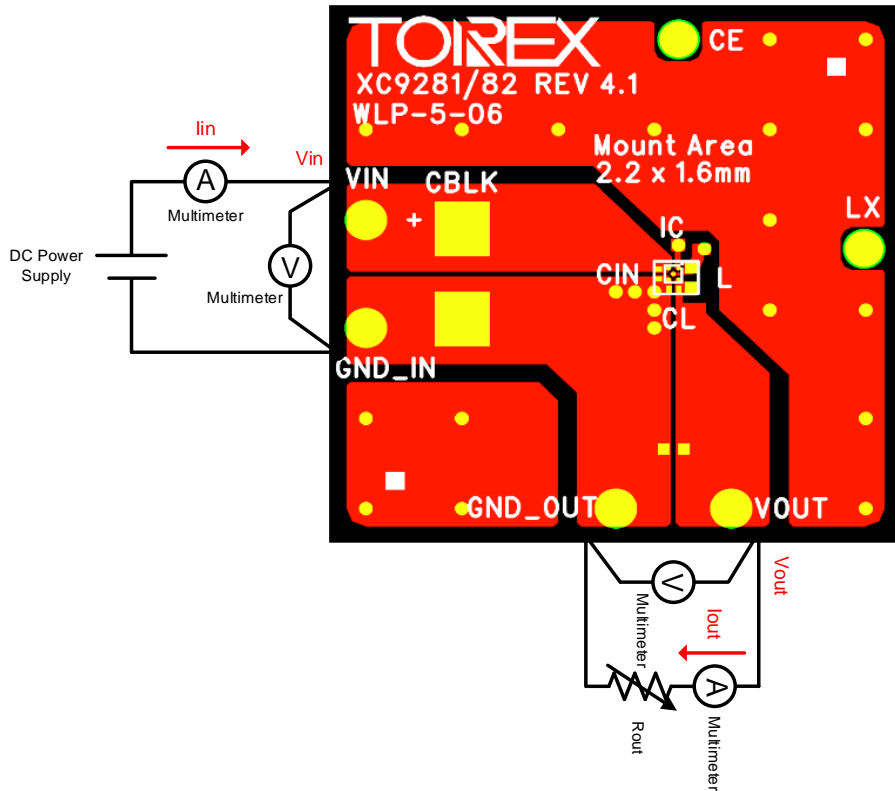

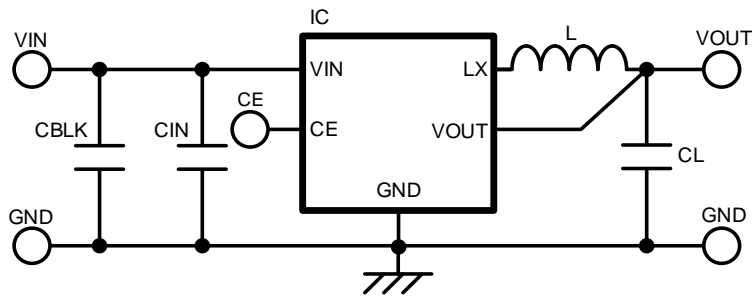
**XC9282B33E0R-G Evaluation Board***HiSAT-COT Control, 0.6A Synchronous Step-Down DC/DC Converters***Schematic****BOM*****Required Circuit Component***

Item	Value	Description	Size [mm]	Part Number	Manufacture
IC	-	5.5V/0.6A Step-down DC/DC	WLP-5-06	XC9282B33E0R-G	TOREX
L	0.47uH	Inductor, 0.47uH	1005	MCEE1005TR47MHN	Taiyo Yuden
CIN	4.7uF	Ceramic cap., 6.3V/4.7uF	0603	GRM035R60J475ME15D	Murata
CL	4.7uF	Ceramic cap., 6.3V/4.7uF	0603	GRM035R60J475ME15D	Murata

***Additional Demo Board Circuit Components***

Item	Value	Description	Size [mm]	Part Number	Manufacture
CBLK	10uF	Ceramic cap., 50V/10uF	3225	CGA6P3X7S1H106K	TDK

**XC9282B33E0R-G Evaluation Board**

*HiSAT-COT Control, 0.6A Synchronous Step-Down DC/DC Converters*

**PCB Layout**

Layer 1

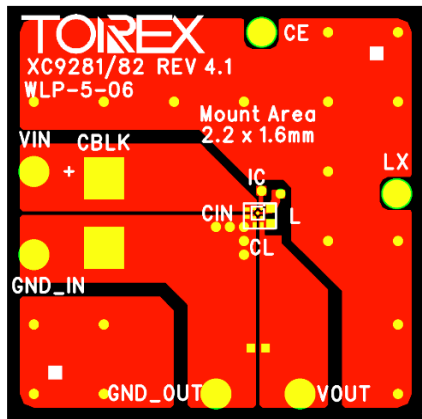

Layer 2

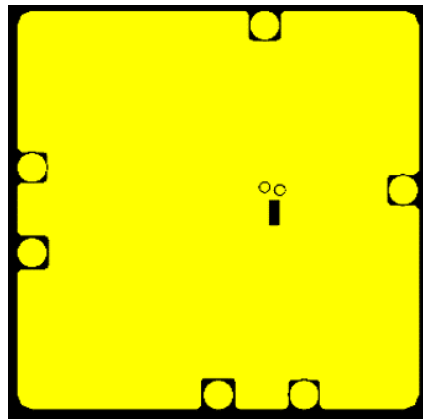

Layer 3

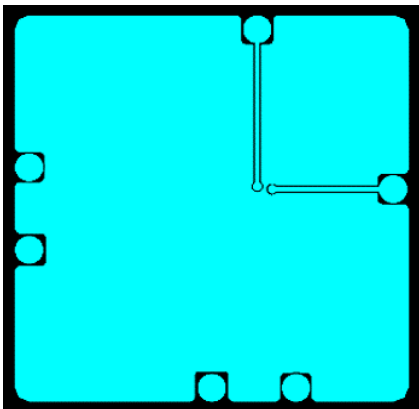

Layer 4

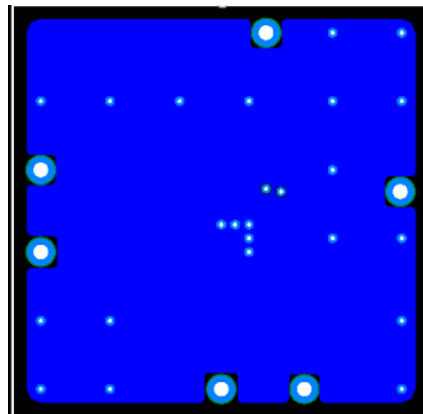

**XC9282B33E0R-G Evaluation Board**

HiSAT-COT Control, 0.6A Synchronous Step-Down DC/DC Converters

**Test Result**

**(1) Output Voltage vs Output Current @Ta=25°C**

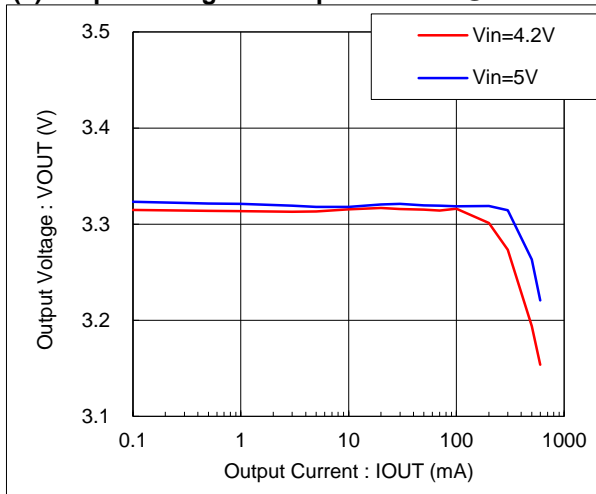

**(2) Efficiency vs Output Current Ta=25°C**

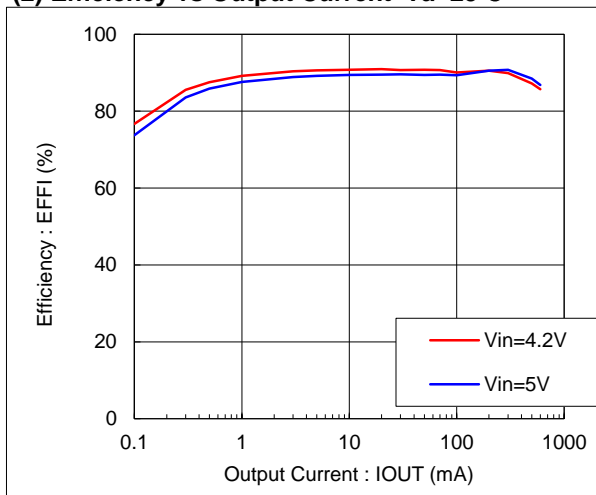

**(3) Ripple Voltage vs Output Current Ta=25°C**

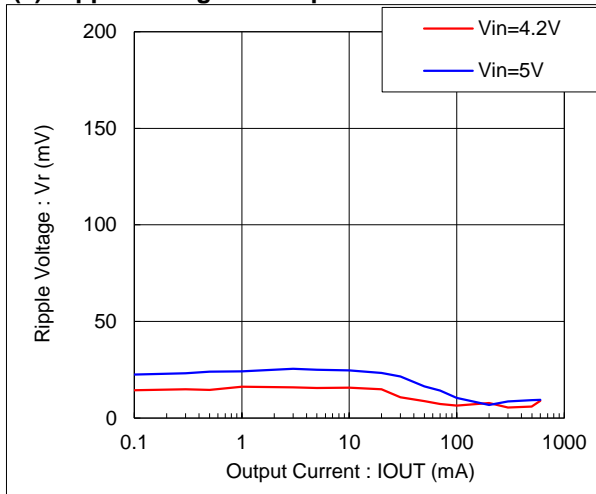

# XC9282B33E0R-G Evaluation Board

HiSAT-COT Control, 0.6A Synchronous Step-Down DC/DC Converters

## Test Result

### (4) Output Voltage Waveform @ Ta=25°C

(4-1) Vin = 5.0V, Iout = 1mA

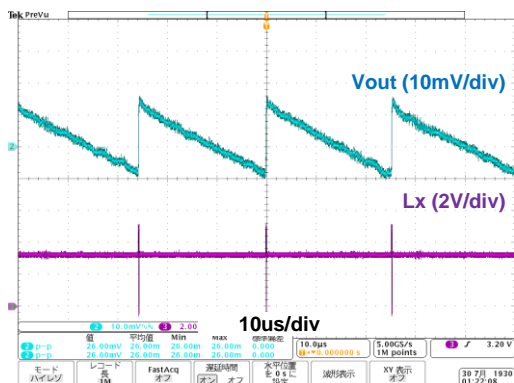

(4-2) Vin = 5.0V, Iout = 300mA

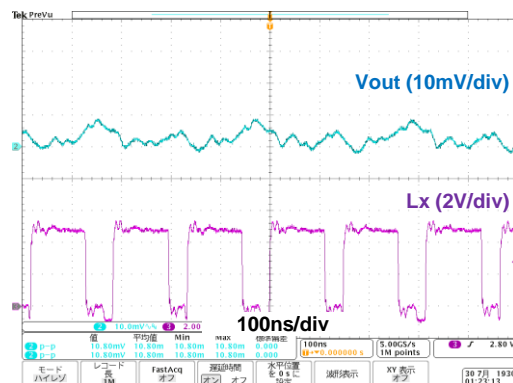

**XC9282B33E0R-G Evaluation Board**

HiSAT-COT Control, 0.6A Synchronous Step-Down DC/DC Converters

**Test Result**

**(5) Start-up Waveform @ Ta=25°C**

(5-1) Vin = 5V, Iout = 10mA

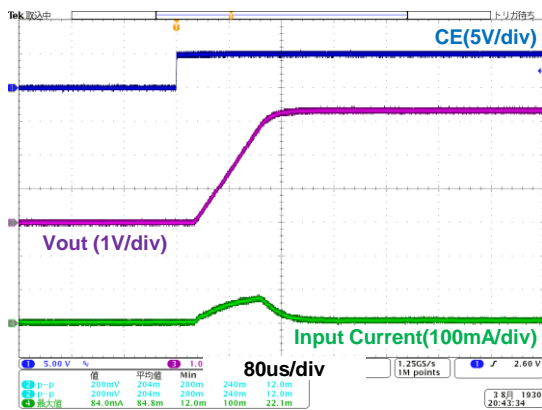

(5-2) Vin = 5V, Iout = 300mA

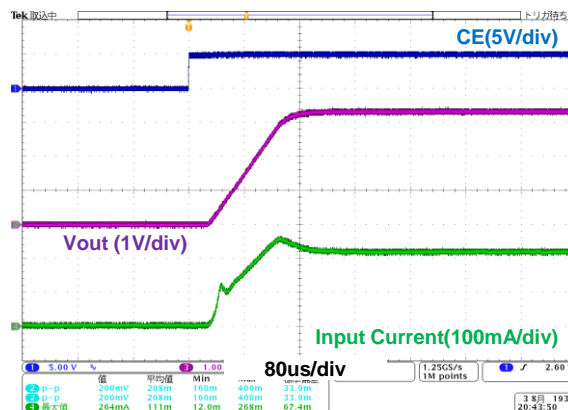



## **XC9282B33E0R-G Evaluation Board**

HiSAT-COT Control, 0.6A Synchronous Step-Down DC/DC Converters

### **Test Result**

(6) Load Transient Waveform @ Ta=25°C

(6-1) Vin = 5V, Iout = 1mA ↔ 300mA

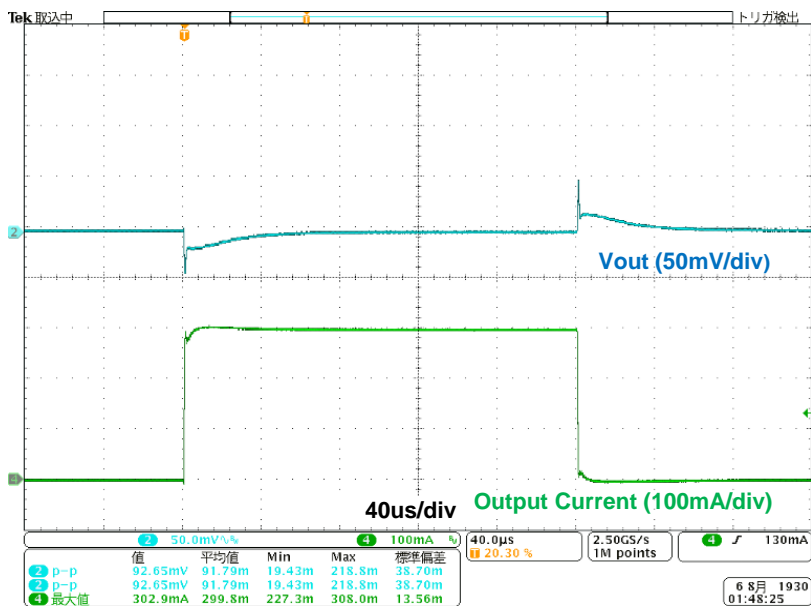

# XC9282B33E0R-G Evaluation Board

HiSAT-COT Control, 0.6A Synchronous Step-Down DC/DC Converters

## Test Result

### (7) Radiation EMI : VCCI 10m

#### Condition

IC : XC9282B18ER-G  
Vin : 3.7V  
Vout : 1.8V  
Iout : 100mA

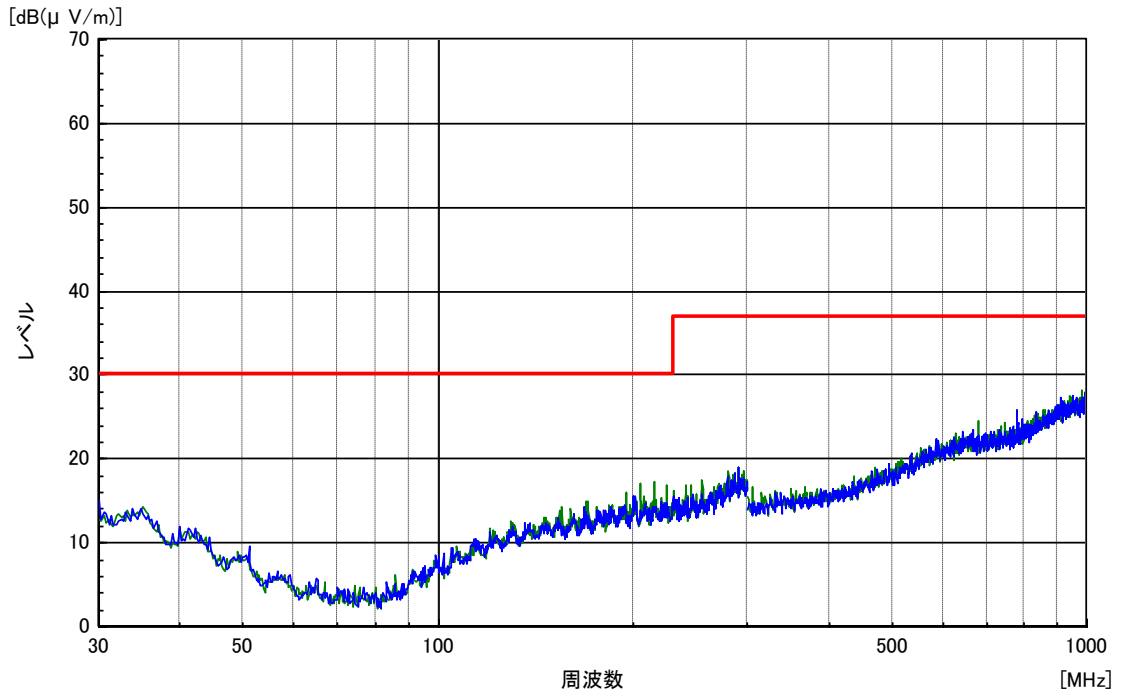

# XC9282B33E0R-G Evaluation Board

HiSAT-COT Control, 0.6A Synchronous Step-Down DC/DC Converters

## 【Appendix】 How to calculate DC/DC Converter or DC/DC Controller.

It can be calculated by the following "WEB DC/DC Simulation".

Product	XC9282 Product Info	Schematic Summary	Waveform	Efficiency Tj, Duty	Ripple Voltage Vin Voltage	Coil Current Input Current	Switching frequency
Switching frequency	<input type="radio"/> 4000 [kHz] <input checked="" type="radio"/> 6000 [kHz]	<div style="border: 1px solid gray; padding: 5px;"> <h3>Efficiency</h3> <h3>Loss Ratio</h3> </div>					
Control Method	<input checked="" type="radio"/> PWM/PFM						
Sim Condition							
Vin	3.6 [V] Range: 2.5V~5.5V						
Vout	3.3 [V] Range: 0.7V~3.6V						
Iout	100 [mA] Range: 0~600mA						
Rvin (Battery Impedance etc)	0 [Ω]						
Ta	25 [°C] Range: -40~105°C						
Thermal resistance: θja	125 [°C/W] Range: 0~1000°C/W						
External Components							
L	0.47 [μH]						
DCR	60 [mΩ]						
CL (Effective Value)	2.35 [μF]						
ESR	10.64 [mΩ]						

- 日本語 : <https://www.torex.co.jp/technical-support/dcdc-simulation/>
- English : <https://www.torexsemi.com/technical-support/dcdc-simulation/>
- 简体中文 : <https://www.torex.com.cn/technical-support/dcdc-simulation/>

# XC9282B33E0R-G Evaluation Board

HiSAT-COT Control, 0.6A Synchronous Step-Down DC/DC Converters

**[Appendix] How to reduce the spike noise caused by measurement (Probing method with oscilloscope)**

**Probing method : Before improvement**

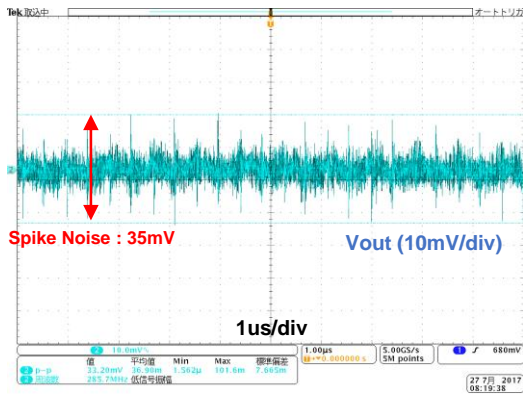
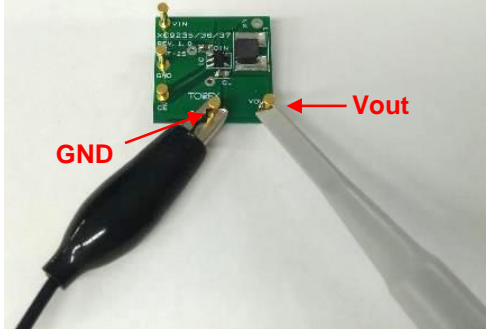

**Probing method : After**

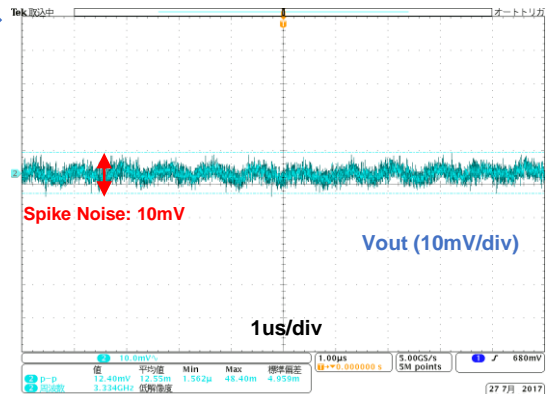
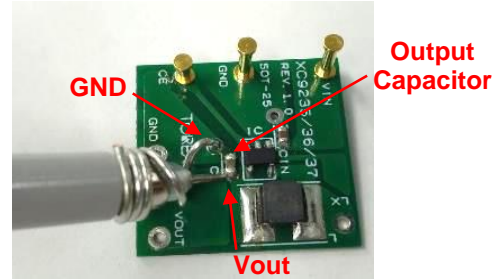

\* Condition : XC9236, Vin=3.6V/Vout=1.8V/100mA

English : <https://www.torexsemi.com/technical-support/tips/reduction-spike-noise/>

日本語 : <https://www.torex.co.jp/technical-support/tips/reduction-spike-noise/>