

IPS511/IPS511S

Features

- Over temperature protection (with auto-restart)
- Short-circuit protection (current limit)
- Active clamp
- E.S.D protection
- Status feedback
- Open load detection
- Logic ground isolated from power ground

Truth Table

| Op. Conditions | In | Out | Dg |
|------------------|----|--------------|----|
| Normal | H | H | H |
| Normal | L | L | L |
| Open load | H | H | H |
| Open load | L | H | H |
| Over current | H | L (limiting) | L |
| Over current | L | L | L |
| Over-temperature | H | L (cycling) | L |
| Over-temperature | L | L | L |

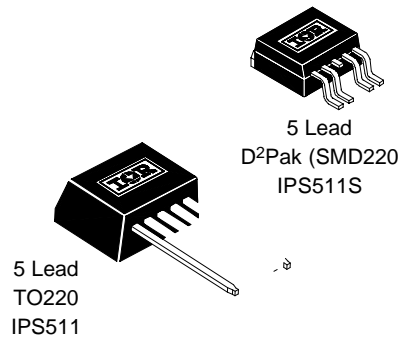
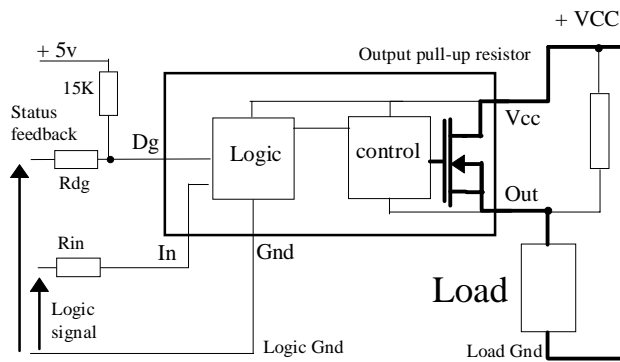

Absolute Maximum Ratings

Absolute maximum ratings indicate sustained limits beyond which damage to the device may occur. All voltage parameters are referenced to GROUND lead. ($T_j = 25^\circ\text{C}$ unless otherwise specified).

| Symbol | Parameter | Min. | Max. | Units | Test Conditions |
|------------------|---|-------------|--------------|-------|-----------------------|
| V_{out} | Maximum output voltage | $V_{CC}-50$ | $V_{CC}+0.3$ | V | |
| V_{offset} | Maximum logic ground to load ground offset | $V_{CC}-50$ | $V_{CC}+0.3$ | | |
| V_{in} | Maximum Input voltage | -0.3 | 5.5 | | |
| $V_{CC\ max}$ | Maximum Vcc voltage | — | 50 | | |
| $I_{in, max.}$ | Maximum IN current | -5 | 10 | mA | |
| V_{dg} | Maximum diagnostic output voltage | -0.3 | 5.5 | V | |
| $I_{dg, max}$ | Maximum diagnostic output current | -1 | 10 | mA | |
| $I_{sd\ cont.}$ | Diode max. permanent current ⁽¹⁾ | — | 2.2 | A | |
| $I_{sd\ pulsed}$ | Diode max. pulsed current ⁽¹⁾ | — | 10 | | |
| ESD1 | Electrostatic discharge voltage (Human Body) | — | 4 | kV | C=100pF, R=1500Ω, |
| ESD2 | Electrostatic discharge voltage (Machine Model) | — | 0.5 | | C=200pF, R=0Ω, L=10μH |
| P_d | Maximum power dissipation ⁽¹⁾ ($TC=25^\circ\text{C}$) IPS511 ($r_{th}=80^\circ\text{C/W}$) IPS511S | — | 25 | W | |
| | | — | 1.56 | | |
| | | | | | |
| $T_j\ max.$ | Max. storage & operating junction temp. | -40 | +150 | °C | |
| T_{lead} | Lead temperature (soldering 10 seconds) | — | 300 | | |

Thermal Characteristics

| Symbol | Parameter | Min. | Typ. | Max. | Units | Test Conditions |
|-------------|---|------|------|------|-------|-----------------------------|
| $R_{th\ 1}$ | Thermal resistance junction to case | — | 5 | — | °C/W | TO-220 |
| $R_{th\ 2}$ | Thermal resistance junction to ambient | — | 60 | — | | |
| $R_{th\ 1}$ | Thermal resistance with standard footprint | — | 60 | — | | |
| $R_{th\ 2}$ | Thermal resistance with 1" square footprint | — | 40 | — | | D ² PAK (SMD220) |
| $R_{th\ 3}$ | Thermal resistance junction to case | — | 5 | — | | |
| | | | | | | |

(1) Limited by junction temperature (pulsed current limited also by internal wiring)

Recommended Operating Conditions

These values are given for a quick design. For operation outside these conditions, please consult the application notes.

| Symbol | Parameter | Min. | Max. | Units |
|--|---|------|------|-------|
| V _{CC} | Continuous V _{CC} voltage | 5.5 | 35 | V |
| V _{IH} | High level input voltage | 4 | 5.5 | |
| V _{IL} | Low level input voltage | -0.3 | 0.9 | |
| I _{out} T _{amb} =85°C | Continuous output current (T _{Ambient} = 85°C, T _J = 125°C, R _{th} < 60°C/W) IPS511 (T _{Ambient} = 85°C, T _J = 125°C, R _{th} = 80°C/W) IPS511 | — | 1.7 | A |
| | | — | 1.5 | |
| R _{in} | Recommended resistor in series with IN pin | 4 | 6 | kΩ |
| R _{dg} | Recommended resistor in series with DG pin | 10 | 20 | |

Static Electrical Characteristics

(T_J = 25°C, V_{CC} = 14V unless otherwise specified.)

| Symbol | Parameter | Min. | Typ. | Max. | Units | Test Conditions |
|---|--|------|------|------|-------|--|
| R _{ds(on)} @T _J =25°C | ON state resistance T _J = 25°C | — | 110 | 135 | mΩ | V _{in} = 5V, I _{out} = 2.5A |
| R _{ds(on)} (V _{CC} =6V) | ON state resistance @ V _{CC} = 6V | — | 110 | 135 | | V _{in} = 5V, I _{out} = 1A |
| R _{ds(on)} @T _J =150°C | ON state resistance T _J = 150°C | — | 200 | — | | V _{in} = 5V, I _{out} = 2.5A |
| V _{CC oper.} | Operating voltage range | 5.5 | — | 35 | V | |
| V _{clamp 1} | V _{CC} to OUT clamp voltage 1 | 50 | 56 | — | | I _d = 10mA (see Fig.1 & 2) |
| V _{clamp 2} | V _{CC} to OUT clamp voltage 2 | — | 58 | 65 | | I _d = I _{sd} (see Fig.1 & 2) |
| V _f | Body diode forward voltage | — | 0.9 | 1.2 | | I _d = 2.5A, V _{in} = 0V |
| I _{CC off} | Supply current when OFF | — | 16 | 50 | μA | V _{in} = 0V, V _{out} = 0V |
| I _{CC on} | Supply current when ON | — | 0.7 | 2 | mA | V _{in} = 5V |
| I _{CC ac} | Ripple current when ON (AC RMS) | — | 20 | — | μA | V _{in} = 5V |
| V _{dgl} | Low level diagnostic output voltage | — | 0.15 | 0.4 | V | I _{dg} = 1.6 mA |
| I _{oh} | Output leakage current | — | 60 | 110 | μA | V _{out} = 6V |
| I _{ol} | Output leakage current | 0 | — | 25 | | V _{out} = 0V |
| I _{dg} leakage | Diagnostic output leakage current | — | — | 10 | | V _{dg} = 5.5V |
| V _{ih} | IN high threshold voltage | — | 2.3 | 3 | V | |
| V _{il} | IN low threshold voltage | 1 | 1.95 | — | | |
| I _{in, on} | On state IN positive current | — | 70 | 200 | μA | V _{in} = 5V |
| I _{n hyst.} | Input hysteresis | 0.1 | 0.25 | 0.5 | V | |

Switching Electrical Characteristics

$V_{CC} = 14V$, Resistive Load = 5.6Ω , $T_j = 25^\circ C$, (unless otherwise specified).

| Symbol | Parameter | Min. | Typ. | Max. | Units | Test Conditions |
|---------------|---|------|------|------|-----------|-----------------|
| T_{don} | Turn-on delay time | — | 7 | 50 | μs | See figure 3 |
| T_{r1} | Rise time to $V_{out} = V_{CC} - 5V$ | — | 10 | 50 | | |
| T_{r2} | Rise time $V_{CC} - 5V$ to $V_{out} = 90\%$ of V_{CC} | — | 45 | 100 | | |
| dV/dt (on) | Turn ON dV/dt | — | 1.3 | 4 | $V/\mu s$ | |
| E_{on} | Turn ON energy | — | 400 | — | μJ | |
| T_{doff} | Turn-off delay time | — | 15 | 50 | μs | See figure 4 |
| T_f | Fall time to $V_{out} = 10\%$ of V_{CC} | — | 10 | 50 | | |
| dV/dt (off) | Turn OFF dV/dt | — | 2 | 6 | | |
| E_{off} | Turn OFF energy | — | 80 | — | μJ | |
| T_{diag} | V_{out} to V_{diag} propagation delay | — | 5 | 15 | μs | See figure 6 |

Protection Characteristics

| Symbol | Parameter | Min. | Typ. | Max. | Units | Test Conditions |
|------------------|-------------------------------------|------|------|------|------------|-----------------|
| I_{lim} | Internal current limit | 3 | 5 | 7 | A | $V_{out} = 0V$ |
| T_{sd+} | Over-temp. positive going threshold | — | 165 | — | $^\circ C$ | See fig. 2 |
| T_{sd-} | Over-temp. negative going threshold | — | 158 | — | $^\circ C$ | See fig. 2 |
| V_{sc} | Short-circuit detection voltage (3) | 2 | 3 | 4 | V | See fig. 2 |
| $V_{open\ load}$ | Open load detection threshold | 2 | 3 | 4 | V | |

(3) Referenced to V_{CC}

Lead Assignments

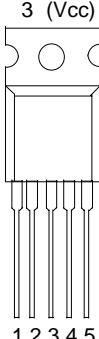
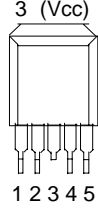
| | | |
|---|---|---|
|  <p>3 (Vcc)</p> <p>1 2 3 4 5</p> <p>5 Lead - TO220</p> | <p>1 - Ground 2 - In 3 - Vcc 4 - DG 5 - Out</p> |  <p>3 (Vcc)</p> <p>1 2 3 4 5</p> <p>5 Lead - D²PAK (SMD220)</p> |
| IPS511 | | IPS511S |
| Part Number | | |

Functional Block Diagram

All values are typical

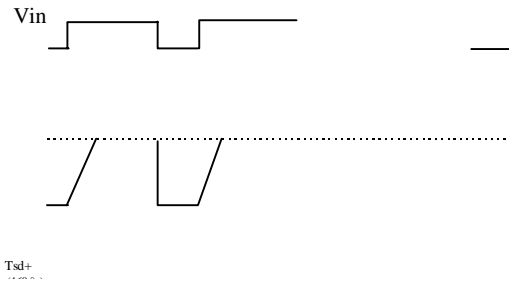
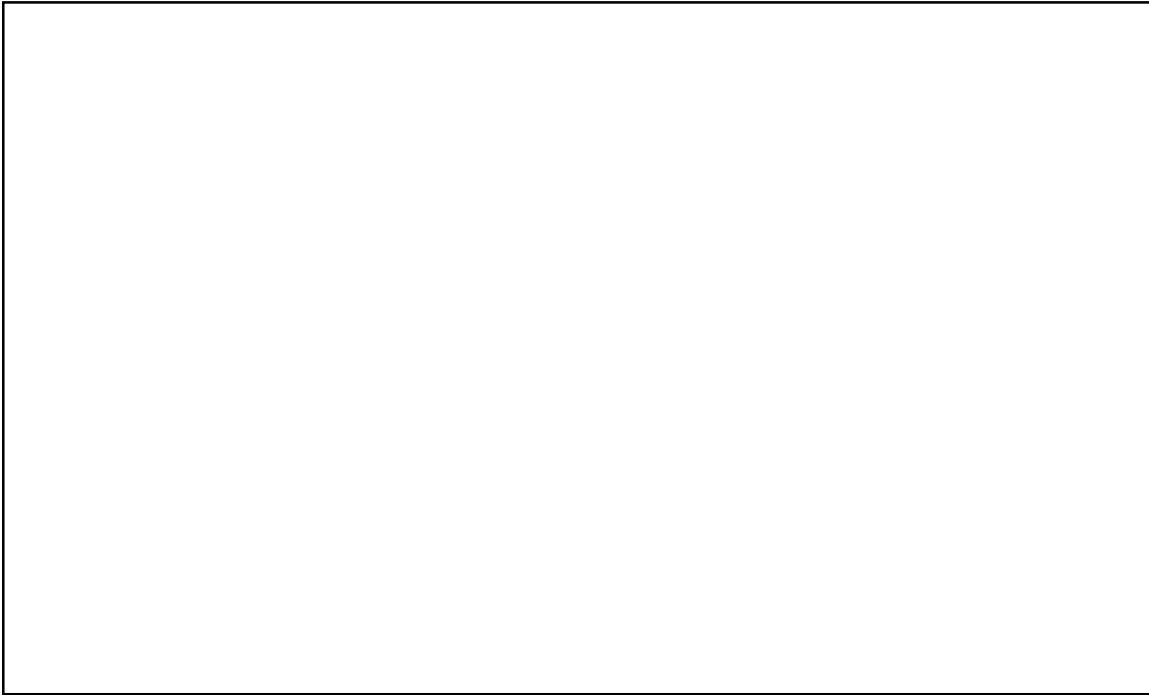
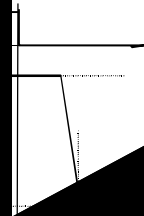

Figure 1 - Active clamp waveforms

Figure 2 - Protection timing diagram

Int

on (turn-off)



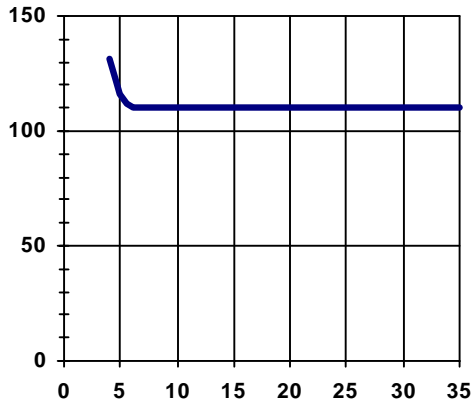

Figure 7 - R_{ds(on)} (mΩ) Vs V_{CC} (V)

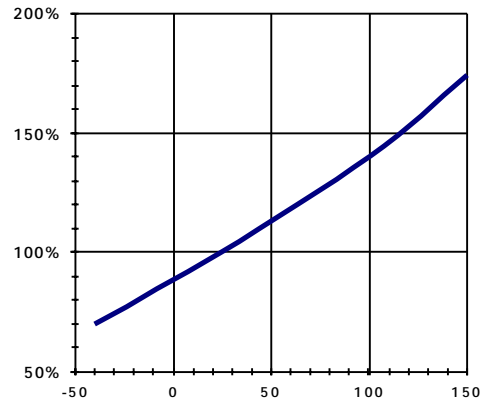

Figure 8 - Normalized R_{ds(on)} (%) Vs T_j (°C)

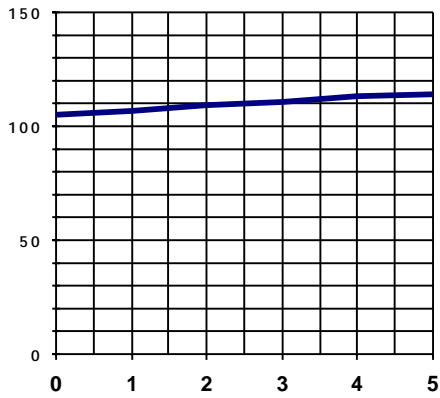

Figure 9 - R_{ds(on)} (mΩ) Vs I_{out} (A)

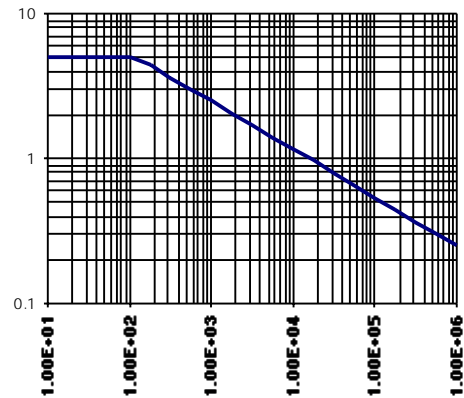

Figure 10 - Max. I_{out} (A) Vs Load Inductance (μH)

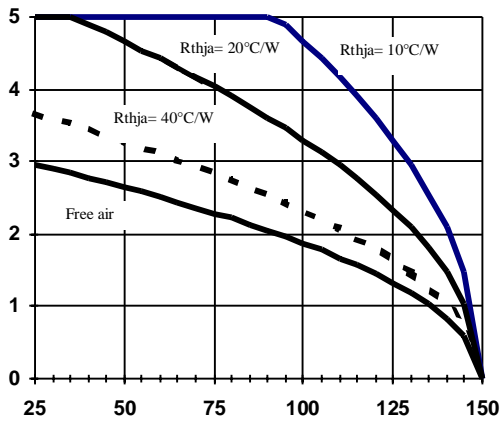

Figure 11a - Max load current (A) Vs Tamb (°C)
IPS511

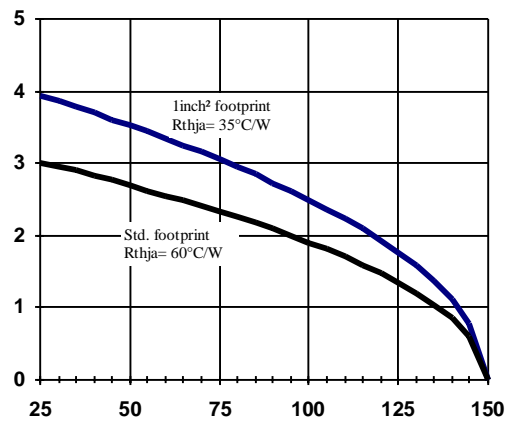

Figure 11b - Max load current (A) Vs Tamb (°C)
IPS511S

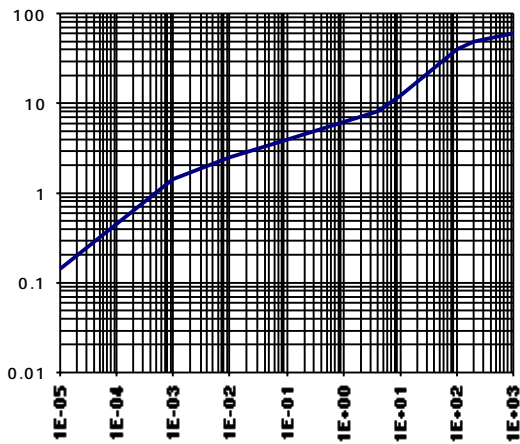

Figure 12 - Transient Thermal Impedance (°C/W)
Vs Time (S)

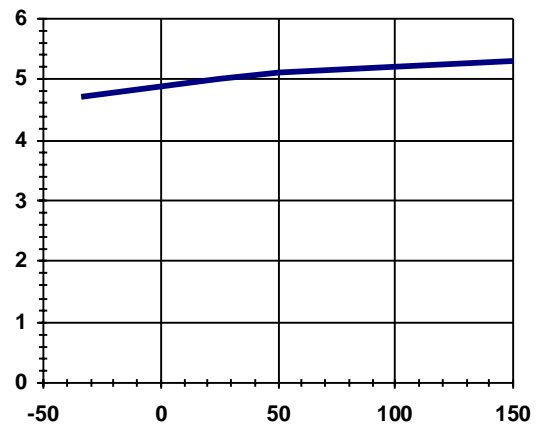

Figure 13 - Ilim (A) Vs Tj (°C)

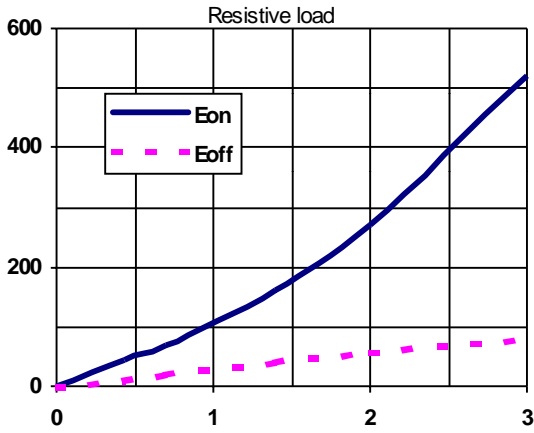

Figure 14 - E_{on}, E_{off} (μJ) (A) Vs I_{out} (A)

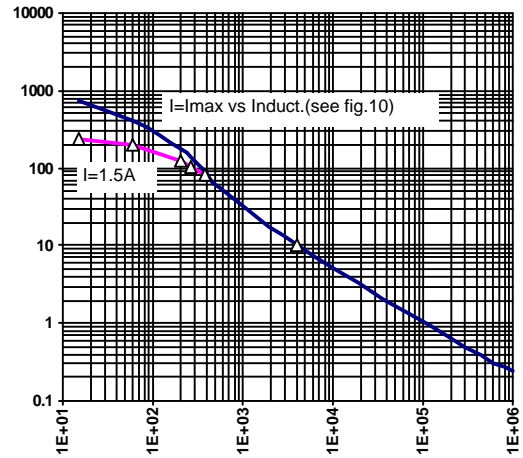

Figure 15 - E_{on} (μJ) Vs Load Inductance (μH)
(see Fig. 3)

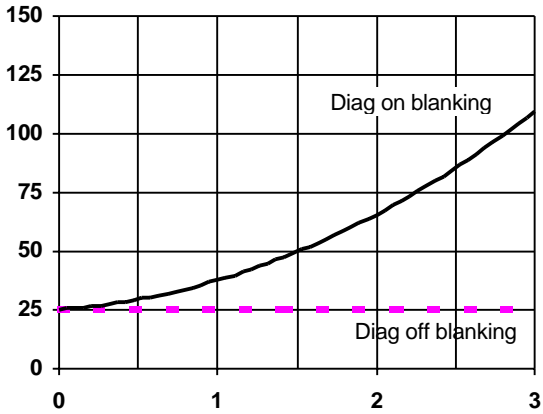

Figure 16 - Diag Blanking time (μs) Vs I_{out} (A)
(resistive load - see Fig. 6)

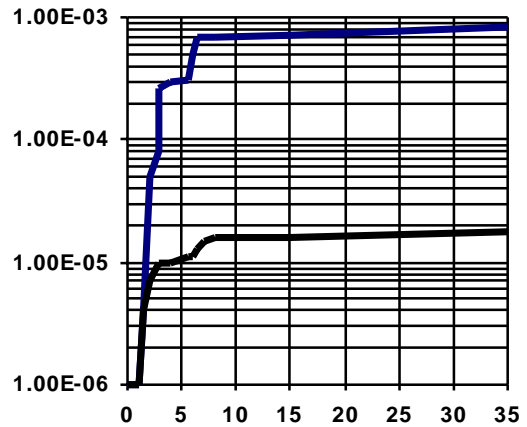

Figure 17 - I_{CC} (mA) Vs V_{CC} (V)

IPS511/IPS511S

International
IR Rectifier

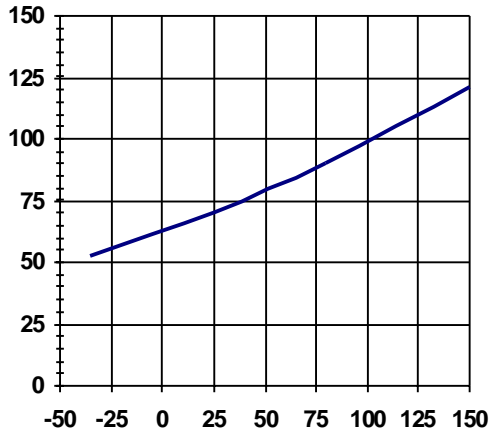
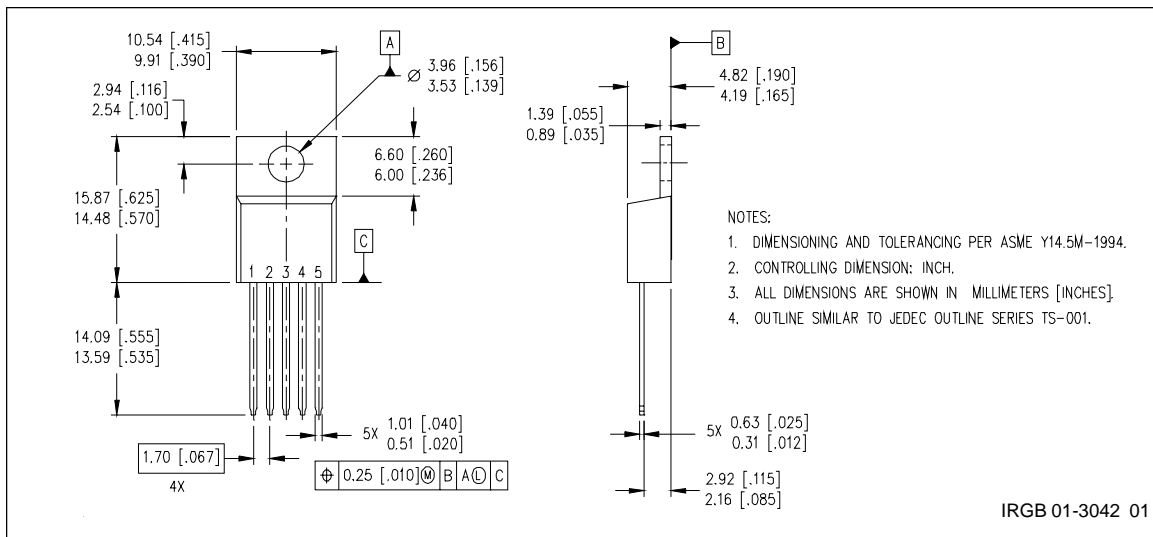
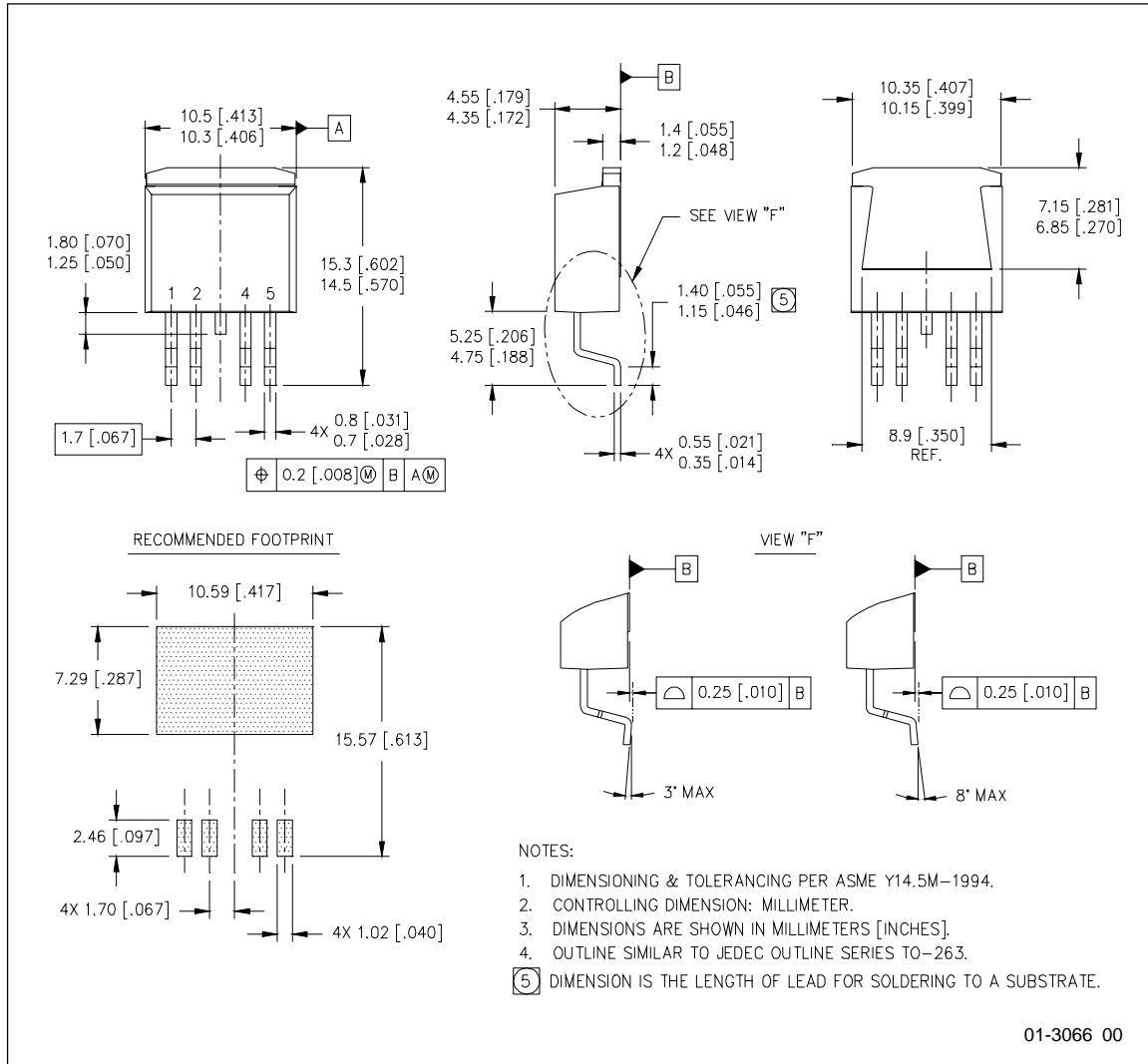

Figure 18 - I_{in} @ V_{in} = 5V (μA) Vs T_j (°C)

Case Outline 5 Lead - TO220



Case Outline 5 Lead - D²PAK (SMD220)



Tape & Reel 5 Lead - D²PAK (SMD220)

