

2203859-1 ✓ ACTIVE

AMP | AMPSEAL 16

TE Internal #: 2203859-1

AMPSEAL 16, Housing for Female Terminals, Wire-to-Wire, 16 Position, 7.5mm Centerline, Sealable, Black, Wire & Cable, 25A Contact Current Rating (Max)

[View on TE.com >](#)



Connectors > Automotive Connectors > Connector Housings



Connector & Housing Type: **Housing for Female Terminals**

Mating Pin Diameter: **2.37 mm**

Connector System: **Wire-to-Wire**

Number of Positions: **16**

Centerline (Pitch): **7.5 mm**

Features

Product Type Features

Connector & Housing Type	Housing for Female Terminals
Connector System	Wire-to-Wire
Sealable	Yes
Hybrid Connector	No
Primary Locking Feature	Integrated in Housing
Connector & Contact Terminates To	Wire & Cable

Configuration Features

Blank Cavity Position	0
Number of Positions	16
Number of Rows	3

Electrical Characteristics

Nominal Voltage Architecture	24 V
------------------------------	------

Body Features

Cable Exit Angle	180
------------------	-----



Body Material	PBT
Primary Product Color	Black
Connector Code	A
Contact Features	
Mating Pin Diameter	2.37 mm
Contact Current Rating (Max)	25 A
Mechanical Attachment	
Mounting Feature	Without
Terminal Position Assurance	Yes
Strain Relief	Add By Accessory
Mating Alignment Type	Polarized
Connector Mounting Type	Bulkhead
Housing Features	
Centerline (Pitch)	7.5 mm
Dimensions	
Product Width	48.09 mm
Product Length	72.7 mm
Product Height	43.5 mm
Row-to-Row Spacing	7 mm
Usage Conditions	
Operating Temperature (Max)	125 °C
Operating Temperature Range	-40 – 125 °C, -40 – 125 °C
Operation/Application	
Circuit Application	Power & Signal
Industry Standards	
Degree of Protection	IP69K
UL Flammability Rating	UL 94HB
Packaging Features	
Packaging Quantity	80
Packaging Method	Tray
Other	



Serviceable	No
Connector Position Assurance Capable	Yes

Product Compliance

[For compliance documentation, visit the product page on TE.com>](#)

EU RoHS Directive 2011/65/EU	Compliant
EU ELV Directive 2000/53/EC	Compliant
China RoHS 2 Directive MIIT Order No 32, 2016	No Restricted Materials Above Threshold
EU REACH Regulation (EC) No. 1907/2006	Current ECHA Candidate List: JUL 2021 (219) Candidate List Declared Against: DEC 2014 (161) SVHC > Threshold: Not Yet Reviewed
Halogen Content	BFR/CFR/PVC Free, but Br/Cl >900 ppm in other sources.
Solder Process Capability	Not applicable for solder process capability

Product Compliance Disclaimer

This information is provided based on reasonable inquiry of our suppliers and represents our current actual knowledge based on the information they provided. This information is subject to change. The part numbers that TE has identified as EU RoHS compliant have a maximum concentration of 0.1% by weight in homogenous materials for lead, hexavalent chromium, mercury, PBB, PBDE, DBP, BBP, DEHP, DIBP, and 0.01% for cadmium, or qualify for an exemption to these limits as defined in the Annexes of Directive 2011/65/EU (RoHS2). Finished electrical and electronic equipment products will be CE marked as required by Directive 2011/65/EU. Components may not be CE marked. Additionally, the part numbers that TE has identified as EU ELV compliant have a maximum concentration of 0.1% by weight in homogenous materials for lead, hexavalent chromium, and mercury, and 0.01% for cadmium, or qualify for an exemption to these limits as defined in the Annexes of Directive 2000/53/EC (ELV). Regarding the REACH Regulation, the information TE provides on SVHC in articles for this part number is based on the latest European Chemicals Agency (ECHA) 'Guidance on requirements for substances in articles' posted at this URL: <https://echa.europa.eu/guidance-documents/guidance-on-reach>

Compatible Parts



TE Part # 2203956-1
COVER,AMPSEAL 16 ML CONN, 180 DEG



TE Part # 2203956-2
PIN CONN CVR,16POS,HYBRID,180 DEG



TE Part # 2272307-1
COVER,AMPSEAL 16 ML CONN, 90 DEG



TE Part # 2272307-2
PIN CONN CVR,16POS,HYBRID,90 DEG



Also in the Series | AMPSEAL 16

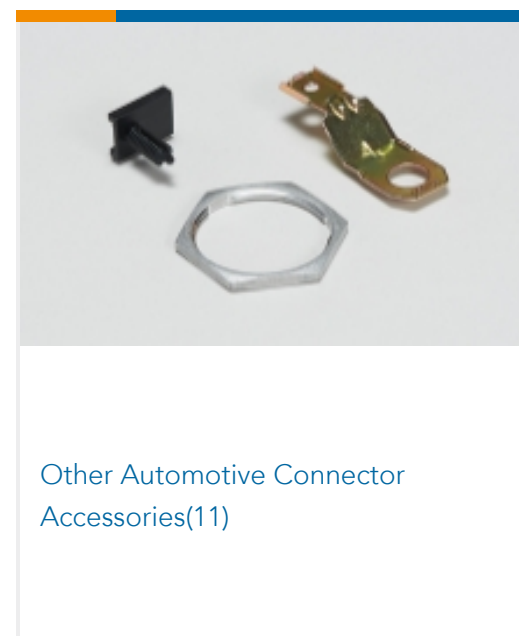
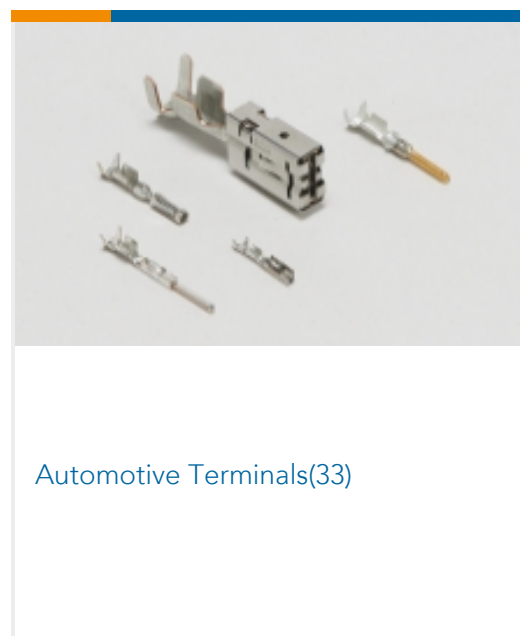
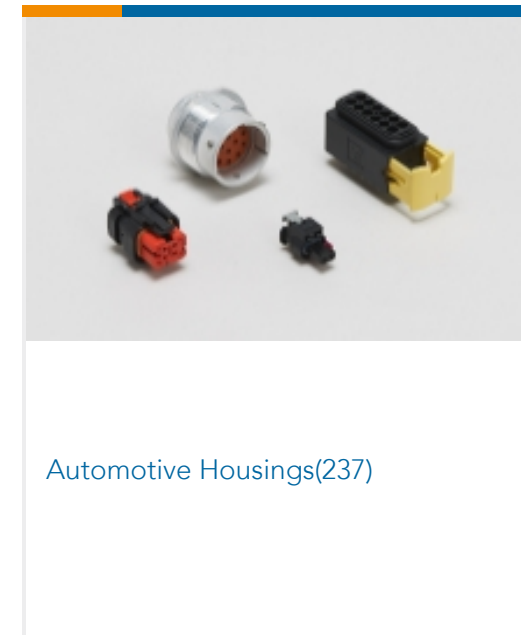
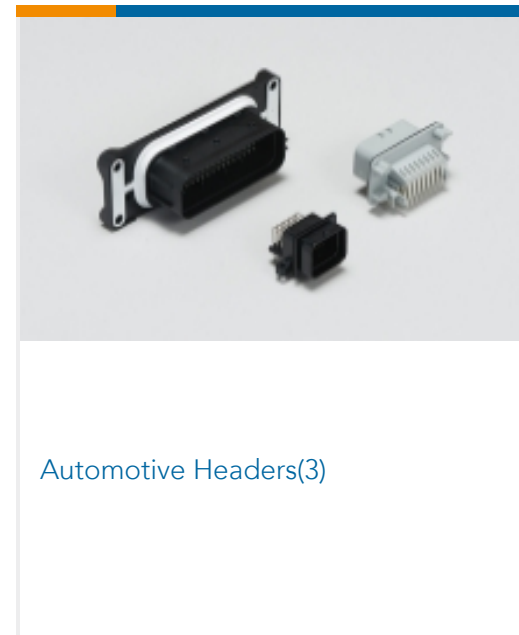
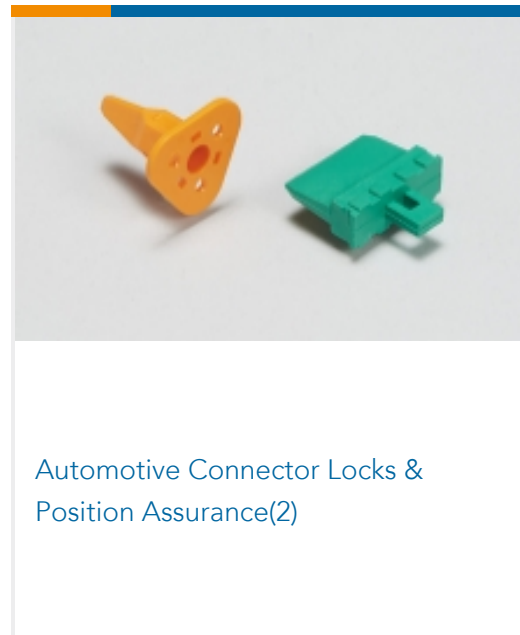
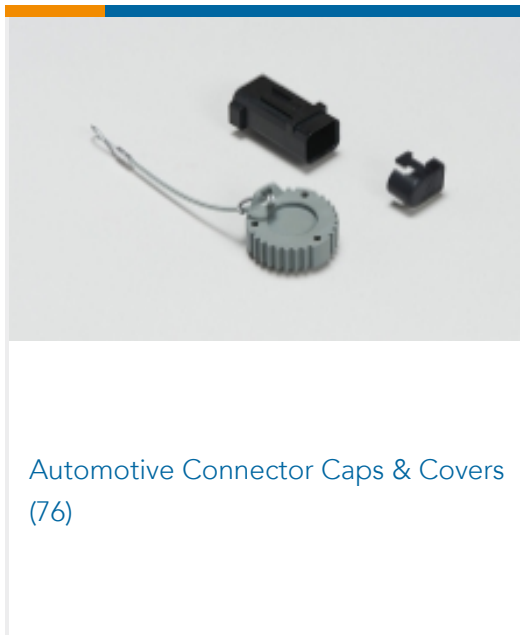

Customers Also Bought

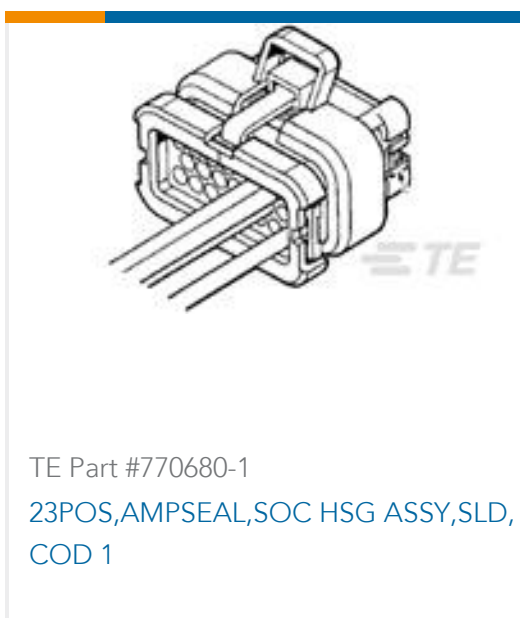



Documents

Product Drawings

[16POS, HYBRID, SOC HSG ASSY, SLD, COD A](#)

English

CAD Files

[3D PDF](#)

3D

Customer View Model

[ENG_CVM_CVM_2203859-1_2.2d_dxf.zip](#)

English

Customer View Model

[ENG_CVM_CVM_2203859-1_2.3d_igs.zip](#)

English

Customer View Model

[ENG_CVM_CVM_2203859-1_2.3d_stp.zip](#)

English

By downloading the CAD file I accept and agree to the [Terms and Conditions](#) of use.

Product Specifications

[Application Specification](#)

English