

P.C.B. MOUNTING PLAN

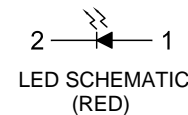
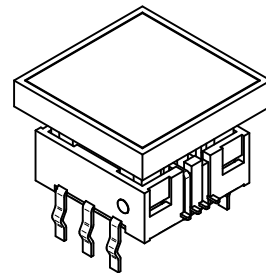
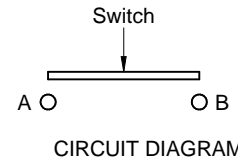
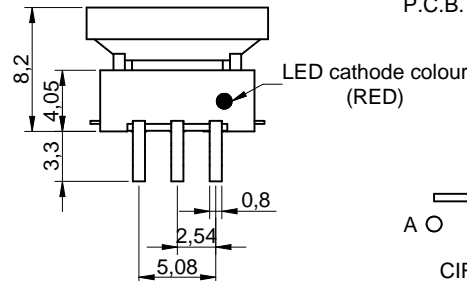
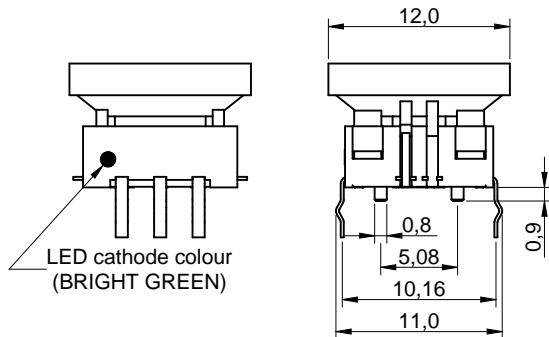

Scale - 2:1

TECHNICAL CHARACTERISTICS

SPECIFICATION

- >Rating: 50mA, 12VDC
- >Contact Resistance:
 - Initial: 100mOHM max.
 - After Life Test: 2mOHM max.
- >Insulation Resistance: min. 100MOHM at 500VDC
- >Dielectric Strength: 500VAC for 1 minute
- >Stroke: 0.3 ± 0.1 mm
- >Bounce: 10ms max.

MATERIAL

- >Diffuser plate: PC UL HB
- >Actuator: PA66 UL HB
- >Frame: PA66 UL HB, color Black
- >Contact: Stainless Steel with Ag
- >Terminal: Brass with Ag
- >LED Terminal: Brass with Tin
- >Rubber: Silicone

SOLDERING INFORMATION

- >Terminal in THT version
- >Wave soldering 260°C 10 sec. max.
- >Hand soldering under 350°C for 3 sec. max

ENVIRONMENTAL

- >Storage condition: -40°C ~ +85°C, 60% RH max.
- >Operation condition: -40°C ~ +85°C
- >MSL Level: 3
- >Compliance: ROHS, Reach

HANDLING ADVISE

- >ESD prevention methods need to be applied for manual handling and processing by machinery
- >Resistors for protection are obligator

PACKAGING INFORMATION

>ESD Tray

PN	Force	Color of LED	Life cycle
440 VR670 82622	220g ± 50gf	Red/Bright Green	100.000

This electronic component is designed and developed with the intention for use in general electronics equipments.

Before incorporating the components into any equipments in the field such as aerospace, aviation, nuclear control, submarine, transportation, (automotive control, train control, ship control), transportation signal, disaster prevention, medical, public information network etc. where higher safety and reliability are especially required or if there is possibility of direct damage or injury to human body, Würth Elektronik must be asked for a written approval.

In addition, even electronic component in general electronic equipments, when used in electrical circuits that require high safety, reliability functions or performance, the sufficient reliability evaluation-check for the safety must be performed before by the user before usage.

			GENERAL TOLERANCE .x = +/- 0,2 .xx = +/- 0,15		Basic material	
			Date	Name	DESCRIPTION	
			Drawn	13-10-09	Fandrey	WS-TATL 12x12mm Tact Switch with integrated LED,THT version
			Checked	13-10-09	Hsu	
c	LED Terminal: Brass with Tin	15-03-02	DaF	Würth Elektronik eiCan		Scale 2:1
b	revised MatchCode	14-07-28	AL			Position
a	Bounce 10ms max.	14-04-14	DaF			Drawing.- No. 440VR67082622
REV	FILE	DATE	BY	EDV NO	440VR67082622.dft	System :Solid Edge V20
						SIZE
						A4

item	Emitting color		Yellow	Red	bright green	green	Blue
	Order code	unit	YS	RS	VS	GS	BS
1	Peak wavelength typ.	nm	590	650	574	520	468
2	Dominant Wave length	typ.nm	590	630	567	525	470
	@IF=20mA						
3	spectral Line Half-width	typ.nm	20	28	20	35	21
	@IF=20mA						
4	Capacitance	typ.pF	20	35	15	100	100
	Vf=0V;f=1MHZ						
5	Forward voltage	typ. V	2	1,95	2,1	3,2	3,2
	@IF=20mA	max.V	2,5	2,5	2,5	4	4
6	Reverse current	uA	10	10	10	10	10
	@VR=5V						
7	ESD	V	2000	2000	2000	1000	1000
8	Viewing Angle	°	145	145	145	145	145
	@20mA 2θ 50% typ						
9	Luminous intensity	min. mcd	80	120	20	80	20
	@IF=20mA	typ. mcd	180	220	50	150	50
10	Material		AlGaInP	AlGaInP	AlGaInP	InGaN	InGaN
11	lens type		water clear	water clear	water clear	water clear	water clear

Absolute Maximun Ratings (Ambient Temperature 25C)

Properties	Blue & green	Red	yellow	bright green	Unit
Power Dissipation	120	75	75	75	mW
Peak Forward current	100	185	175	150	mA
continuous Forward current	30	30	30	30	mA
Reverse voltage	5	5	5	5	V
ESD Threshold / HBM	1000	2000	2000	2000	V

HANDLING ADVISE

- 1) The solder profile has to be complied with according to the technical reflow /or wave soldering specification, otherwise no warranty will be sustained
- 2) All products are supposed to be used before the end of the period of 12 months based on the product date-code, if not 100% solderability can't be warranted
- 3) Violation of the technical product specifications such as exceeding the absolute maximum ratings will be result in the loss of warranty
- 4) It's also recommended to return the products into the original packaging
- 5) ESD prevention methods need to be applicated for manual handling and processing by machinery
- 6) Resistors for protection are obligatory
- 7) The standard deliveries include values in the range and limitation as defined in the Electrical & Optical Properties specified in the datasheet. On each reel, only one bin is sorted and taped. The bin is defined on intensity, chromaticity coordinate or wavelength and forward voltage. In order to ensure highest availability, the reel binning of standard deliveries can vary. A single bin cannot be ordered. Please contact us in advance, if you need a particular bin sorting before placing your order to clarify the lead time, MOQ and pricing.

This electronic component is designed and developed with the intention for use in general electronics equipments.

Before incorporating the components into any equipments in the field such as aerospace, aviation, nuclear control, submarine, transportation, (automotive control, train control, ship control), transportation signal, disaster prevention, medical, public information network etc. where higher safety and reliability are especially required or if there is possibility of direct damage or injury to human body, Würth Elektronik must be asked for a written approval.

In addition, even electronic component in general electronic equipments, when used in electrical circuits that require high safety, reliability functions or performance, the sufficient reliability evaluation-check for the safety must be performed before by the user before usage.

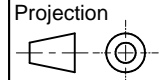
		GENERAL TOLERANCE		Basic material	
		.x = +/- 0,2 .xx = +/- 0,15			
		Date	Name	DESCRIPTION	
		Drawn	13-10-09	Fandrey	SwTLT
		Checked			WS-TLT 12x12mm Tact Switch with integrated LED, THT version
				Scale 2:1	Position
				Drawing.- No. 440VR67082622	
REV	FILE	DATE	BY	EDV NO 440VR67082622.dft	System :Solid Edge V20