

CHF Series

Self-contained heating units designed for optimum operating efficiency and performance—

Providing trouble-free service and application flexibility!

All of the heat generated by the elements is immediately transferred to the medium being processed with minimal losses.

Standard and optional features include...

General purpose (NEMA 1) terminal housing is standard. Moisture proof (NEMA 4) and/or explosion resistant (NEMA 7) housings are optional. A set of installation and maintenance instructions along with a wiring diagram can be found inside the terminal housing of each unit.

Heating source—32 and 64 mm (1¼" and 2½") screw plug heaters are used on smaller units. 76 to 356 mm (3 to 14") size heaters use flanged immersion heaters. The flanges are made from forged steel rated for 150 lbs with raised face. Supplied with threaded eyebolts for ease of handling and installation. Optional stainless steel flanges or 300 lb ratings available.

Inlet-outlet connections are NPT pipe threads for 76 to 203 mm (3 to 8") circulation heaters (flanges are optional). Standard inlet-outlet connections on 254 mm (10") and larger units are 150 lb rated flanges.

Optional feature double-pole non-indicating bulb and capillary type thermostat can be located in the terminal box (standard) or attached to the insulation jacket as pictured. Solid state temperature controllers and indicating thermostats are available. Over-temperature protection can be provided by attaching a thermocouple to one of the elements.

Threaded mounting lugs to support the unit are welded to the steel vessel. Custom supports can be designed to fit your structure.

Wide selection of heating element sheath materials for maximum corrosion resistance to the medium being processed. On smaller circulation units with screw plug heaters, the element diameter is 8 or 12 mm (0.315 or 0.475"). On larger units with flanged heaters, the element diameter is 12 mm (0.475").

The vessel is surrounded with 25 mm (1") thick insulation rated to 399°C (750°F) to minimize heat loss. Additional insulation or a high temperature ceramic fiber insulation is optional. Vessels can also be supplied uninsulated.

Vessel material is SA53B or SA106B steel. Good for up to 399°C (750°F) operating temperature. For drainage and cleaning purposes, a drain plug is located in the base of the tank. Optional: stainless steel vessel.

Outer stainless steel sheet metal jacket protects the insulation from the environment and keeps it dry. Optional: Stainless steel outer jacket with a weather-tight seal.

Note: Branch Circuit Wiring—Flange heater elements are wired into branch circuits having a maximum current of 48 Amps. The number of circuits is listed next to the heater's voltage and phase in the To Order tables. For different circuit wiring configurations, consult Omega.

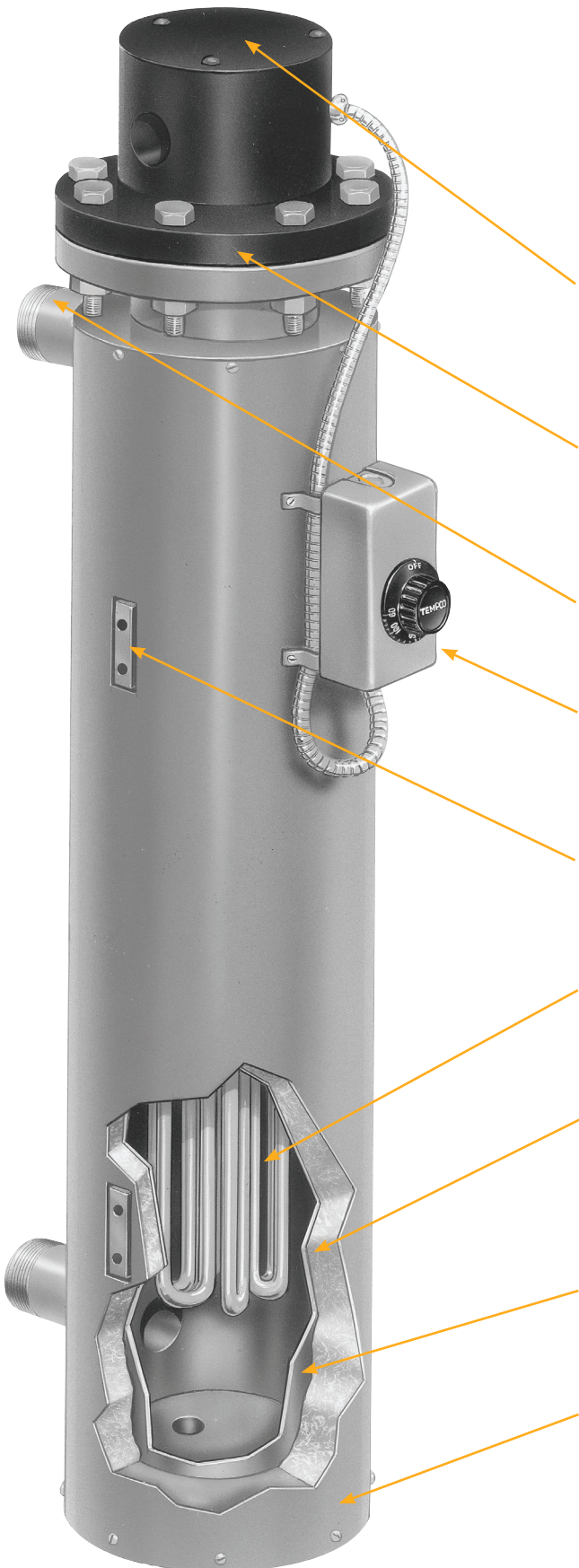



Checklist for Selecting the Proper Circulation Heater

✓ Determine a Safe and Efficient Element Watt Density

Element Watt Density is the wattage dissipated per square inch of the element sheath surface and is calculated with the following formula:

$$\text{Watt Density} = \frac{\text{element wattage}}{\pi \times \text{element diameter} \times \text{element heated length}}$$

For a particular application, element watt density will govern element sheath temperature. Factors to consider when choosing a suitable watt density are:

1. Many materials are heat sensitive and can decompose or be damaged if the element is running too hot.
2. Air and other gases that are poor conductors of heat require watt densities matched to the velocity of the gas flow to prevent element overheating.
3. Mineral deposits when heating hard water and cleaning solutions can build up on the element sheath, acting as a heat insulator and raising the internal element temperature. If these deposits cannot be periodically removed, use a lower watt density element to increase heater life expectancy.

✓ Select the Element Sheath Material

Sheath Material Selection

CORROSION. In addition to selecting a sheath material that is compatible with the heated medium, other factors that affect corrosion need to be considered:

1. The temperature of the corrodent—As temperature increases the degree of corrosion increases. Also remember that usually the element temperature is higher than the material it is heating.
2. The degree of aeration to which a corrodent is exposed—Stagnant conditions can deprive the stainless steels of oxygen, which is required to maintain their corrosion resistant surface.
3. Velocity of the corrodent—Increased velocity can increase the corrosion rate.

Standard Element Sheath Materials

Incoloy® 800 — A Nickel (30 to 35%), Chromium (19 to 23%), Iron alloy. The high nickel content of this alloy contributes to its resistance to scaling and corrosion. Used in air heating (also see Incoloy® 840) and immersion heating of potable water and other liquids that are not corrosive to an Incoloy® 800 sheath.

Low Carbon Steel — Applications include fluid heat transfer media, tar, high to low viscosity petroleum oils, asphalt, wax, molten salt, and other solutions not corrosive to a steel sheath.

316 Stainless Steel — A Chromium (16 to 18%), Nickel (11 to 14%), Iron Alloy with Molybdenum (2 to 3%) added to improve corrosion resistance in certain environments, especially those that would tend to cause pitting due to the presence of chlorides. Applications include deionized water.

Copper — Mainly used in clean water heating for washrooms, showers, rinse tanks and freeze protection of storage tanks.

Optional Element Sheath Materials

304 Stainless Steel — A Chromium (18 to 20%), Nickel (8 to 11%), Iron Alloy used in the food industry, sterilizing solutions, air heating and many organic and inorganic chemicals.

321 Stainless Steel — A Chromium (17 to 20%), Nickel (9 to 13%), Iron Alloy modified with the addition of titanium to prevent carbide precipitation and the resulting intergranular corrosion that can take place in certain mediums when operating in the 427 to 649°C (800 to 1200°F) temperature range.

Incoloy® 840 — A Nickel (18 to 20%), Chromium (18 to 22%), Iron alloy. Incoloy 840 has about 10% less nickel than Incoloy 800. Used in many air heating applications where it has exhibited superior oxidation resistance at less cost than Incoloy 800.

Incoloy® 825 — A Nickel (38 to 46%), Chromium (19.5 to 23.5%), Molybdenum (2 to 3%) Iron alloy. Consult Omega for more information.

Surface Treatments for Stainless Steel and Incoloy® Elements and Other Wetted Parts to Improve Corrosion Resistance

Flanged immersion heater surfaces in contact with the material being heated can be passivated or electro-polished to improve their resistance to corrosion.

Passivation removes surface contamination, usually iron, so that the optimum corrosion resistance of the stainless steel is maintained. Surface contamination would come from the small amount of steel that may be worn off a tool during the manufacturing process. Passivating is accomplished by dipping the heater in a warm solution of nitric acid.

Electro-Polishing is an electrochemical process that removes surface imperfections and contaminants, enhancing the corrosion resisting ability of the stainless steels. The resultant surface is clean, smooth and bright. Many medical and food applications require this finish.

✓ Standard Terminal Housings

Omega circulation heaters are supplied with a General Purpose Housing (NEMA 1) as standard unless otherwise specified.

Additional housing types include:

- Moisture Resistant (NEMA 4)
- Explosion Resistant (NEMA 7)
- Moisture/Explosion Resistant (NEMA 4/7)



Explosion resistant terminal housings are intended to provide containment of an explosion in the enclosure only. No portion of the heater assembly outside the enclosure is covered under this NEMA rating. Abnormal use of a heater which results in excessive temperature can create hazardous conditions such as a fire. Never perform any type of service nor remove the housing cover prior to disconnecting all electrical power to the heater.

Optional Terminal Housing Standoff Construction



The electrical housing is separated from the flange by an air gap (six-inch standard) to lower the ambient temperature of the electrical wiring. This option is used on flanged immersion heaters where the flange temperature exceeds 250°C (482°F).

Optional Circulation Heater Features

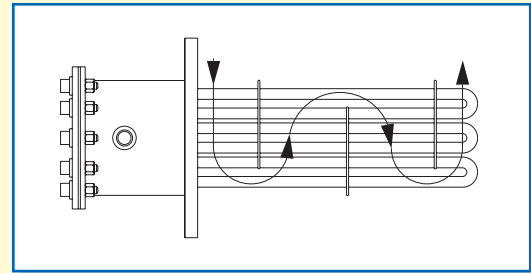

Flow Control Baffles

Used on circulation tank heaters to aid heat transfer by forcing the liquid or gas back and forth across the elements. Baffles can be custom designed and positioned for your application.

Temperature Control

Thermostats

Thermostats are an optional feature on flanged immersion heaters. This type of control operates by expansion and contraction of a liquid in response to temperature change. Liquid contained within the sensing bulb and capillary flexes a diaphragm, causing the opening and closing of a snap action switch. For heating applications the contacts are normally closed and open on temperature rise.

Installation Warnings and Recommendations

1. Do not use the thermostat as a power switch. Use some other means of disconnecting power to the heater for servicing.
2. A Thermostat is not a fail-safe device. Use an approved high temperature limit control and/or pressure limit control for safe operation.
3. Avoid kinking or bending the capillary tube too sharply as this will alter the calibration and/or render the thermostat inoperable.
4. Excess capillary tube should be coiled neatly in junction box.
5. The capillary tube must never touch the thermostat contacts as this will create an electrical short capable of harming personnel and/or equipment.

Thermocouples

Type J or Type K thermocouples can be supplied for process temperature or over-temperature control. Type J is reliable and accurate for temperatures up to 538°C (1000°F). Type K should be used for higher temperatures.

For measuring process temperatures the thermocouple can be mounted in a thermowell in the center of the element bundle. Note that a location somewhere away from the heater may give a more accurate measurement of process temperature.

For over-temperature protection the thermocouple is usually attached to one of the elements (Figure A) and any unusual rise in element temperature would shut the heater down. This thermocouple may also be mounted in a thermowell (Figure B), which is then attached to one of the heating elements if desired. This protects the thermocouple from the solution being heated and allows you to replace it without removing the heater, but does increase its response time.

Temperature and over-temperature controls for using the signal generated by thermocouples and how to select the best control for your application can be found at omega.com/controllers

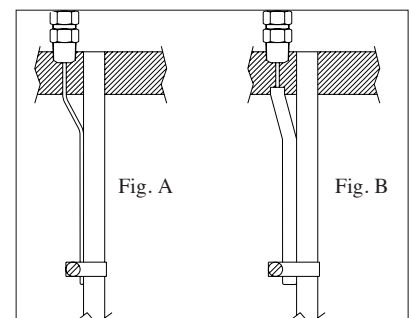

Circulation Heater Installation Recommendations

Omega circulation heaters will have a long life and provide dependable, trouble-free service if properly installed, operated and maintained as per the following recommendations:

Installation

1. Flange heaters are supplied with two drilled and tapped holes for threaded eye bolts, providing ease of handling during installation and flange removal during maintenance cleaning or heater replacement.
2. Replacement of heater is inevitable. Therefore, provide adequate space for installation, allowing ample room to remove the flange heater for cleaning or replacement.
3. In applications requiring the circulation heater to be fed by an inline pump, install the pump at the inlet end.
4. To maintain the lowest possible temperature at the terminal box, place the outlet at the end opposite to the terminal box. If your process temperature is circulating at 232°C (450°F) or above (at the nozzle closest to the flange), stand-off terminal box construction is recommended.
5. To prevent temperature and/or pressure buildup on closed loop circulation heater systems, adequate and strategically located thermocouples for temperature controllers and pressure relief valves should be installed. Never over-rate pressure relief valves beyond the pressure temperature rating of the flange being used.
6. During the process cycle, flow rate of the medium being heated should never be interrupted or reduced, thus creating an overheating condition. Excess temperature can result in damage to the medium being processed and premature heater failure.
7. Make sure that your circulation heater is equipped with the proper terminal housing for the environment in which the heater is being used. NEMA 1—general purpose, NEMA 4—moisture resistant, and NEMA 7—explosion resistant.

Vertical Mounting—Liquids:
With terminal housing up and inlet pipe on the bottom, the heating elements will be immersed at all times to prevent premature failure.

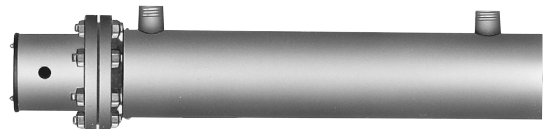

Horizontal Mounting—Liquids and Gases:
Always mount heater with inlet-outlet pipes facing up to ensure the heating elements will be immersed at all times to prevent premature failure. For liquid heating, outlet may be at either end. When heating gases the inlet should be closest to the terminal enclosure to minimize terminal box wiring temperatures.



Vertical Mounting—Gases:
Mount with terminal enclosure and inlet pipe at bottom of tank to minimize terminal box wiring temperatures.

Wiring

1. All heater installations must be properly earth grounded to eliminate electric shock hazard. Electrical wiring must be in accordance with Local and/or National Electrical Codes.
2. Circulation heaters are supplied standard with NEMA 1 terminal housings. All power to heaters must be disconnected before removing the terminal housing cover and performing any type of service.
3. Electrical connections on heater terminals must be kept tight. Loose connections will create arcing, over-heating, and eventually will destroy the heater terminal and cause premature heater failure.
4. If the amperage rating of your circulation heater exceeds the amperage capacity of the supplied thermostat, mercury relays or magnetic contactors should be used with the thermostat.
5. Over-temperature protection thermocouples require a separate conduit to the control panel for the thermocouple wire.
6. Omega offers a large selection of power control panels for circulation heaters. See omega.com/controllers

Maintenance

1. Never perform any type of service on the unit prior to disconnecting all electrical power and shutting off all intake lines.
2. Remove sludge deposits through the drain plug.
3. Check flange bolts for tightness.
4. Check terminal connections for tightness.
5. Check thermocouple or thermostat bulb for response to temperature changes. If defective, replace immediately.
6. Check for leaks.
7. Depending on operating conditions and medium being processed, the flange or screw plug heater should be periodically removed for physical inspection and cleaning of the element bundle.

Circulation Tank Assembly Maximum Immersed Element Length

Standard circulation heaters shown in the tables have element immersion lengths determined by the element wattage and element watt density. The screw plug or flange heater containing the elements is matched to a standard circulation heater tank assembly to assure proper heat transfer and heated material flow. When designing a system

with a heater not shown on these pages the table below can be used to select a tank size based on the calculated immersion length. If a standard tank size is not suitable for your installation, Omega will design and manufacture a custom tank and heater assembly to satisfy the requirements of your application.

Nominal Pipe Size	Dimension Drawing Number	Maximum Immersed Element Length	
		inch	mm
1½ NPT	1.1	18.0	457
	1.2	26.0	660
2½ NPT	2.1	25.5	648
	2.2	35.5	902
	2.3	48.0	1219
3" Flange	3.1	28.0	711
	3.2	38.0	965
	3.3	50.5	1283
4" Flange	4.1	26.5	673
	4.2	37.0	940
	4.3	58.0	1473
	4.4	79.0	2007
5" Flange	5.1	36.0	914
	5.2	43.0	1092
	5.3	54.5	1384
	5.4	68.0	1727
	5.5	85.0	2159
6" Flange	6.1	26.5	673
	6.2	37.0	940
	6.3	58.0	1473
	6.4	79.0	2007

Nominal Pipe Size	Dimension Drawing Number	Maximum Immersed Element Length	
		inch	mm
8" Flange	8.1	32.5	826
	8.2	40.5	1029
	8.3	47.5	1207
	8.4	55.0	1397
	8.5	64.5	1638
	8.6	73.5	1867
	8.7	83.5	2121
10" Flange	10.1	60.0	1524
	10.2	67.0	1702
	10.3	73.0	1854
	10.4	82.0	2083
	10.5	90.0	2286
12" Flange	12.1	59.0	1499
	12.2	66.5	1689
	12.3	74.0	1880
	12.4	81.5	2070
	12.5	89.0	2261
14" Flange	14.1	58.0	1473
	14.2	65.5	1664
	14.3	73.0	1854
	14.4	80.5	2045
	14.5	88.0	2235

8 watts/in² (1.3 watts/cm²) — Typical Applications: Fuel Oils (Bunker C and Number 6)

- Steel Screw Plug and Steel 150 lb Flanged Heater Sizes
- Steel Sheath Heating Elements
- Steel Tank
- NEMA 1 Terminal Housing

Note: 3-Phase only. Cannot be rewired for single phase.

Nominal Pipe Size	Dimensional Drawing Number	KW	Model Number					Approx Weight	
			120V	240V-1Ph (C*)	240V-3Ph (C*)	480V-1Ph (C*)	480V-3Ph (C*)	lb	kg
2½ NPT 3 elements	2.2	2	—	—	CHF01100 (1)	—	CHF01101 (1)	37	17
	2.3	3	—	—	CHF01102 (1)	—	CHF01101 (1)	46	21
3"—150 lb 3 elements	3.2	2	—	—	CHF01104 (1)	—	CHF01105 (1)	62	28
	3.3	3	—	—	CHF01106 (1)	—	CHF01107 (1)	76	34

(C*) = Number of Branch Circuits per heater

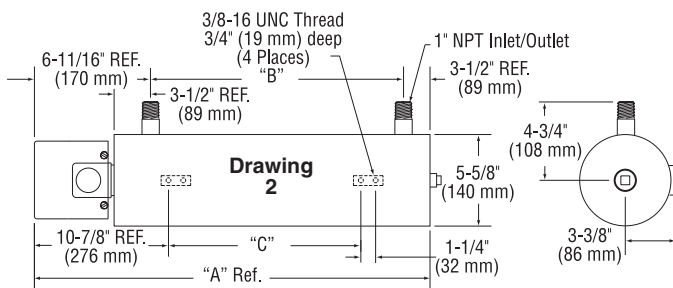

Drawing Number	"A"		"B"		"C"	
	inch	mm	inch	mm	inch	mm
2.2	42 ¹¹ / ₁₆	1084	32½	826	26½	673
2.3	55 ⁵ / ₁₆	1402	45	1143	39	991

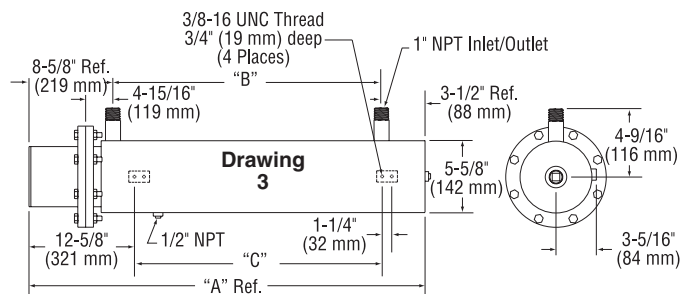

Drawing Number	"A"		"B"		"C"	
	inch	mm	inch	mm	inch	mm
3.2	44 ⁵ / ₈	1133	32½	826	26½	673
3.3	57 ⁵ / ₈	1451	45	1143	39	991



48 watts/in² (7.5 watts/cm²)—Typical Applications: Process Water

- 304 Stainless Steel Screw Plug and Steel 150 lb Flanged Heater Sizes
- Steel Tank
- Incoloy® 800 Sheath Heating Elements
- NEMA 1 Terminal Housing

To Order Visit omega.com/chf6 for Pricing and Details

Nominal Pipe Size	Model Number					Dim Drawing Number	KW	Approx Weight	
	120V	240V-1Ph (C*)	240V-3Ph (C*)	480V-1Ph (C*)	480V-3Ph (C*)			lb	kg
2½ NPT 3 elements	—	CHF01694 (1)	CHF01695 (1)	CHF01696 (1)	CHF01697 (1)	2.1	6	28	13
	—	CHF01698 (1)	CHF01699 (1)	CHF01700 (1)	CHF01701 (1)	2.1	7.5	29	13
	—	CHF01702 (1)	CHF01703 (1)	CHF01704 (1)	CHF01705 (1)	2.1	9	30	14
	—	—	CHF01706 (1)	CHF01707 (1)	CHF01708 (1)	2.2	12	37	17
	—	—	CHF01709 (1)	CHF01710 (1)	CHF01711 (1)	2.3	15	45	20
	—	—	CHF01712 (1)	CHF01713 (1)	CHF01714 (1)	2.3	18	46	21
3"—150 lb 3 elements	—	CHF01715 (1)	CHF01716 (1)	CHF01717 (1)	CHF01718 (1)	3.1	6	53	24
	—	CHF01719 (1)	CHF01720 (1)	CHF01721 (1)	CHF01722 (1)	3.1	7.5	53	24
	—	CHF01723 (1)	CHF01724 (1)	CHF01725 (1)	CHF01726 (1)	3.2	9	61	28
	—	—	CHF01727 (1)	CHF01728 (1)	CHF01729 (1)	3.2	12	62	28
	—	—	CHF01730 (1)	CHF01731 (1)	CHF01732 (1)	3.3	15	74	34
	—	—	CHF01733 (1)	CHF01734 (1)	CHF01735 (1)	3.3	18	76	34

Ordering Example: CHF01708, 12 KW, 480 Vac, 3 phase circulation heater.

(C*) = Number of Branch Circuits per heater

Drawing Number	"A"		"B"		"C"	
	inch	mm	inch	mm	inch	mm
2.1	32 ¹¹ / ₁₆	830	22 ¹ / ₂	572	16 ¹ / ₂	419
2.2	42 ¹¹ / ₁₆	1084	32 ¹ / ₂	826	26 ¹ / ₂	673
2.3	55 ⁵ / ₁₆	1402	45	1143	39	991
3.1	34 ⁵ / ₈	879	22 ¹ / ₂	572	16 ¹ / ₂	419
3.2	44 ⁵ / ₈	1133	32 ¹ / ₂	826	26 ¹ / ₂	673
3.3	57 ¹ / ₈	1451	45	1143	39	991

Note: Circulation heater mounting lug design and location in the assembly drawings shown are standard. Designs can be modified to fit customer installation. Consult Omega with your requirements.

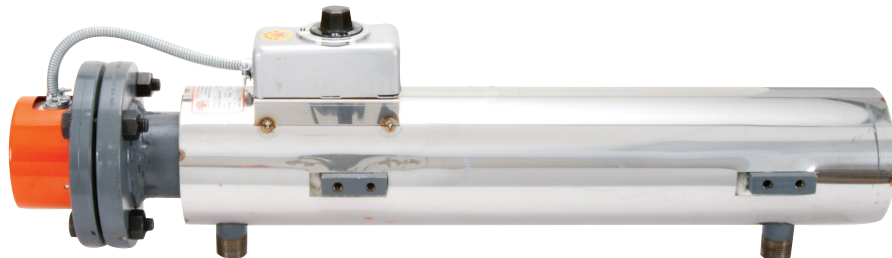
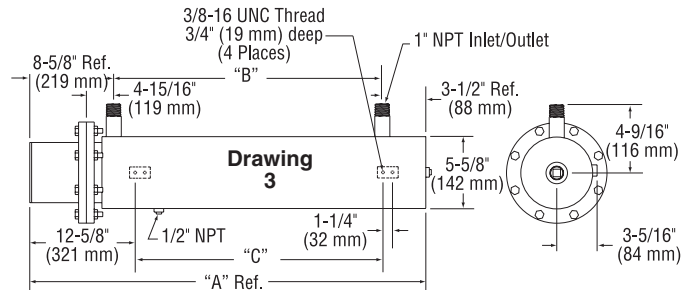
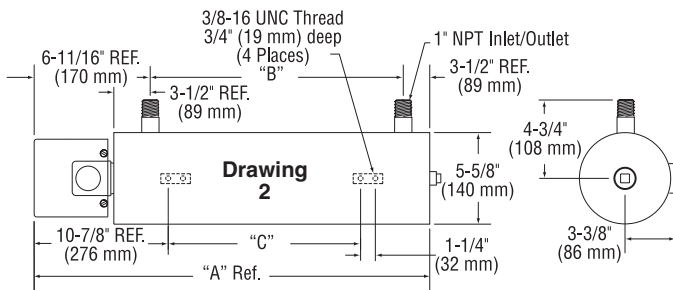

Circulation heater with optional externally mounted thermostat.



Nominal Pipe Size	Model Number					Dim Drawing Number	KW	Approx Weight	
	120V	240V-1Ph (C*)	240V-3Ph (C*)	480V-1Ph (C*)	480V-3Ph (C*)			lb	kg
4"—150 lb 6 elements	—	CHF01736 (1)	CHF01737 (1)	CHF01738 (1)	CHF01739 (1)	4.1	9	76	34
	—	CHF01740 (2)	CHF01741 (1)	CHF01742 (1)	CHF01743 (1)	4.1	12	78	35
	—	CHF01744 (2)	CHF01745 (1)	CHF01746 (1)	CHF01747 (1)	4.1	15	79	36
	—	CHF01748 (2)	CHF01749 (1)	CHF01750 (1)	CHF01751 (1)	4.2	18	91	41
	—	CHF01752 (2)	CHF01753 (2)	CHF01754 (2)	CHF01755 (1)	4.2	24	94	43
	—	—	CHF01756 (2)	CHF01757 (2)	CHF01758 (1)	4.3	30	117	53
	—	—	CHF01759 (2)	CHF01760 (2)	CHF01761 (1)	4.3	36	120	54
5"—150 lb 6 elements	—	CHF01762 (2)	CHF01763 (2)	CHF01764 (2)	CHF01765 (1)	5.1	24	117	53
	—	—	CHF01766 (2)	CHF01767 (2)	CHF01768 (1)	5.2	30	128	58
	—	—	CHF01769 (2)	CHF01770 (2)	CHF01771 (1)	5.3	36	146	66
5"—150 lb 9 elements	—	—	CHF01772 (3)	CHF01773 (3)	CHF01774 (1)	5.1	36	123	56
	—	—	CHF01775 (3)	CHF01776 (3)	CHF01777 (3)	5.2	45	135	61
	—	—	CHF01778 (3)	CHF01779 (3)	CHF01780 (3)	5.3	54	154	70
6"—150 lb 12 elements	—	CHF01781 (2)	CHF01782 (1)	CHF01783 (1)	CHF01784 (1)	6.1	18	124	56
	—	CHF01785 (2)	CHF01786 (2)	CHF01787 (2)	CHF01788 (1)	6.1	24	127	58
	—	CHF01789 (3)	CHF01790 (2)	CHF01791 (2)	CHF01792 (1)	6.1	30	129	59
	—	CHF01793 (3)	CHF01794 (2)	CHF01795 (2)	CHF01796 (1)	6.2	36	152	69
	—	—	CHF01797 (4)	CHF01798 (3)	CHF01799 (2)	6.2	48	157	71
	—	—	CHF01800 (4)	CHF01801 (3)	CHF01802 (2)	6.3	60	197	89
	—	—	CHF01803 (4)	—	CHF01804 (2)	6.3	72	202	92
6"—150 lb 15 elements	—	CHF01805 (3)	CHF01806 (5)	CHF01807 (1)	CHF01808 (1)	6.1	23	126	57
	—	CHF01809 (3)	CHF01810 (5)	CHF01811 (3)	CHF01812 (1)	6.1	30	130	59
	—	CHF01813 (5)	CHF01814 (5)	CHF01815 (3)	CHF01816 (1)	6.1	38	132	60
	—	CHF01817 (5)	CHF01818 (5)	CHF01819 (3)	CHF01820 (5)	6.2	45	156	71
	—	—	CHF01821 (5)	CHF01822 (3)	CHF01823 (5)	6.2	60	163	74
	—	—	CHF01824 (5)	CHF01825 (5)	CHF01826 (5)	6.3	75	204	93
	—	—	CHF01827 (5)	—	CHF01828 (5)	6.3	90	211	96
8"—150 lb 18 elements	—	—	CHF01829 (3)	CHF01830 (3)	CHF01831 (2)	8.2	50	234	106
	—	—	CHF01832 (6)	—	CHF01833 (2)	8.3	75	264	120
	—	—	CHF01834 (6)	—	CHF01835 (3)	8.4	100	293	133
	—	—	CHF01836 (6)	—	CHF01837 (6)	8.5	125	327	148
	—	—	—	—	CHF01838 (6)	8.6	150	360	163
	—	—	—	—	CHF01839 (6)	8.7	175	395	179
	—	—	—	—	CHF01840 (6)	8.7	200	405	184
8"—150 lb 24 elements	—	—	CHF01841 (4)	CHF01842 (3)	CHF01843 (2)	8.2	67	243	110
	—	—	CHF01844 (8)	—	CHF01845 (4)	8.3	100	277	126
	—	—	CHF01846 (8)	—	CHF01847 (4)	8.4	133	308	140
	—	—	CHF01848 (8)	—	CHF01849 (8)	8.5	167	346	157
	—	—	—	—	CHF01850 (8)	8.6	200	382	173
	—	—	—	—	CHF01851 (8)	8.7	233	420	191
	—	—	—	—	CHF01852 (8)	8.7	267	433	196

Nominal Pipe Size	Model Number					Dim Drawing Number	KW	Approx Weight	
	120V	240V-1Ph (C*)	240V-3Ph (C*)	480V-1Ph (C*)	480V-3Ph (C*)			lb	kg
10"—150 lb 27 elements	—	—	—	—	CHF01853 (9)	10.3	225	539	244
	—	—	—	—	CHF01854 (9)	10.5	262	615	279
12"—150 lb 36 elements	—	—	—	—	CHF01855 (12)	12.3	300	694	315
	—	—	—	—	CHF01856 (12)	12.5	350	782	355
14"—150 lb 45 elements	—	—	—	—	CHF01857 (15)	14.2	315	771	350
	—	—	—	—	CHF01858 (15)	14.3	375	827	375

Ordering Example: CHF01788, 24 KW, 480 Vac, 3 phase circulation heater.

(C*) = Number of Branch Circuits per heater

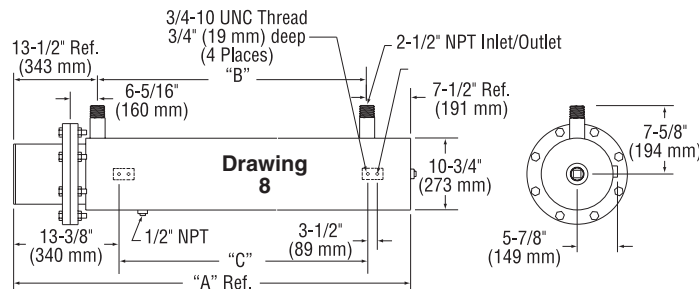
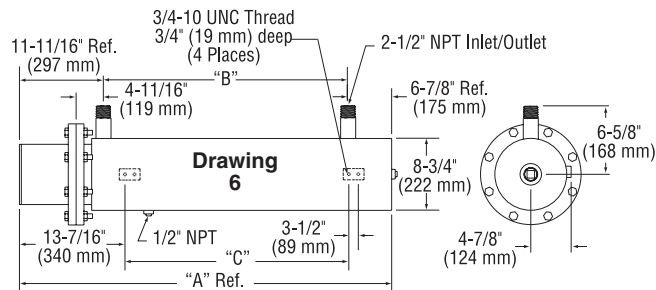
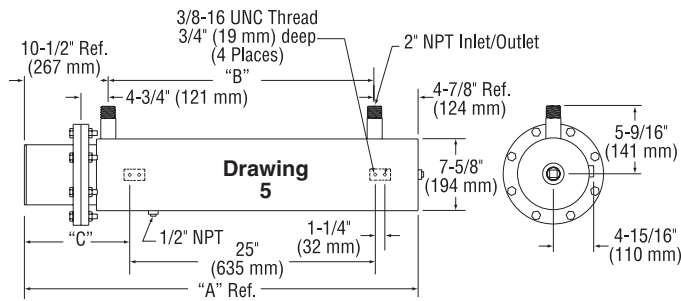
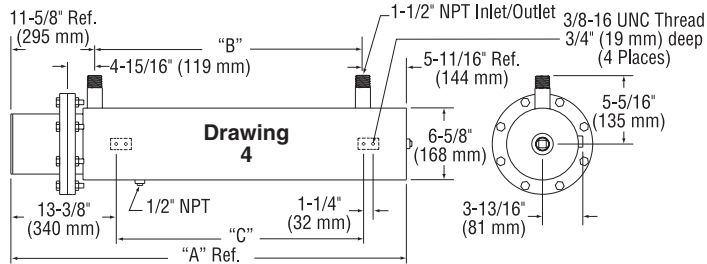

Drawing Number	"A"		"B"		"C"	
	inch	mm	inch	mm	inch	mm
4.1	37 ¹³ / ₁₆	960	20 ¹ / ₂	521	17	432
4.2	48 ⁵ / ₁₆	1227	31	787	27 ¹ / ₂	699
4.3	69 ⁵ / ₁₆	1761	52	1321	48 ¹ / ₂	1232
5.1	45 ³ / ₈	1153	30	762	11 ¹ / ₂	292
5.2	52 ³ / ₈	1330	37	940	15 ¹ / ₄	387
5.3	63 ³ / ₈	1622	48 ¹ / ₂	1232	21	533
6.1	39 ¹ / ₁₆	992	20 ¹ / ₂	521	17	432
6.2	49 ⁹ / ₁₆	1259	31	787	27 ¹ / ₂	699
6.3	70 ⁹ / ₁₆	1792	52	1321	48 ¹ / ₂	1232
8.2	53 ³ / ₄	1365	32 ¹ / ₁₆	830	29 ⁹ / ₁₆	741
8.3	60 ³ / ₄	1543	39 ¹ / ₁₆	1008	36 ³ / ₁₆	919
8.4	68 ³ / ₄	1746	47 ⁹ / ₁₆	1202	43 ¹⁹ / ₁₆	1113
8.5	77 ⁷ / ₈	1978	56 ¹⁹ / ₁₆	1443	53 ³ / ₁₆	1354
8.6	86 ⁷ / ₈	2207	65 ¹⁹ / ₁₆	1672	62 ⁵ / ₁₆	1583
8.7	96 ⁷ / ₈	2461	75 ¹⁹ / ₁₆	1926	72 ⁵ / ₁₆	1837
10.3	89	2261	75 ¹ / ₄	1911	81	2057
10.5	104	2642	90 ¹ / ₄	2292	96	2438
12.3	89 ¹ / ₄	2267	75	1905	81 ¹ / ₈	2061
12.5	104 ¹ / ₄	2648	90	2286	96 ¹ / ₈	2442
14.2	82 ¹ / ₈	2086	66 ¹ / ₈	1699	73 ³ / ₄	1873
14.3	89 ⁵ / ₈	2276	74 ³ / ₈	1889	81 ¹ / ₄	2064

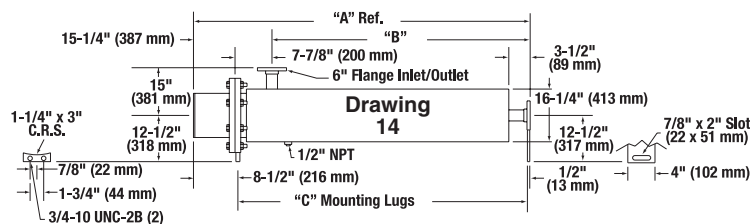
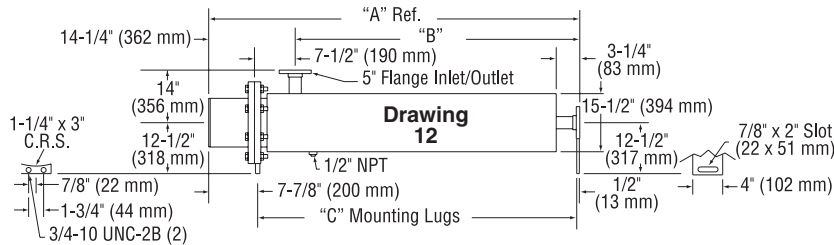
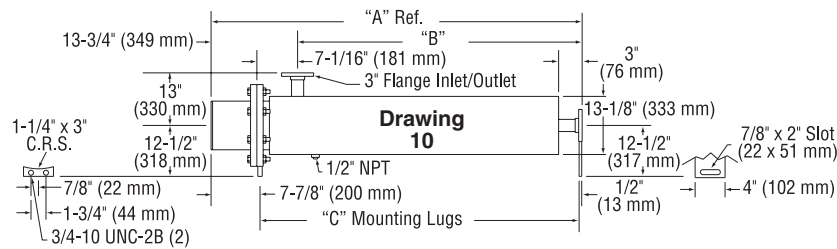

Note: Circulation heater mounting lug design and location in the assembly drawings shown are standard. Designs can be modified to fit customer installation. Consult Omega with your requirements.